



Pumps Sampling Labware

for Laboratory, Industry,
Science

2022

burkle 5378-1011
Prástenkoffel SteriPlast™, PS, steril, 2,5 ml
Sampling spoon SteriPlast™, PS, sterile, 2.5 ml
Culliere SteriPlast™, PS, sterile, 2,5 ml
Cuthara de muestreo SteriPlast™, PS, est
Піпетка ложка «СтеріПласт» 2,5 ml

burkle 190130ME153781012
STERILE P
LOT 191028E1
Prástenkoffel SteriPlast™, PS, steril, 10 ml
Sampling spoon SteriPlast™, PS, sterile, 10 ml
Culliere de laboratoire SteriPlast™, PS, sterile, 10 ml
Cuthara de muestreo SteriPlast™, PS, estéril, 10 ml
Піпетка ложка «СтеріПласт» 10 ml
Certificate of analysis

burkle 5378-1012
Sterilizing StandUp
burkle
www.burkle

Catalogue 2022

What's new?



Novartos
from page 70



Stainless steel beaker, extended
page 97



Disposable funnel for liquids
from page 132



Disposable powder funnel
from page 132



Stainless steel scraper
page 150



Bowl stainless steel, shallow
page 218



Bowl stainless steel, deep form
page 218



Tray stainless steel
page 220

We are available for you by Live Chat and WhatsApp!

Do you have any questions about one of our products or about your order?
Chat directly with one of our sales employees!

Our General Terms and Conditions apply to all orders. You can read them on the Internet and print them at www.buerkle.de



+49 7635 8 27 95-0



+49 7635 8 27 95-31



Bürkle GmbH
Rheinauen 5 | 79415 Bad Bellingen



info@buerkle.de



www.buerkle.de/en



facebook.com/buerkle.de



linkedin.com/company/buerkle-gmbh



twitter.com/buerklegmbH



instagram.com/buerklegmbh



buerkle.de/videos



Contact us by WhatsApp:
+49 176 29947486



Live Chat via text, audio or video:
www.buerkle.de/en/chat



Contents

2

Pumps

Container pumps, barrel pumps, dosage pumps, withdrawal systems, barrel connectors, thread adapters, electric pumps, stopcocks, spigots, ball valves

56

Samplers

Samplers for bulk goods, samplers for viscous substances, samplers for liquids, samplers for pharmaceutical products, disposable & sterile samplers, ice and meat sampling, soil sampling

168

Containers

Bottles, spray bottles, wash bottles and dropping bottles, boxes, canisters, wide-mouth containers, storage containers, stacking containers, tubs, big containers, safety containers, packaging containers

212

Industrial & laboratory equipment

Trays, bowls, buckets, draining racks, burettes, funnels, graduated beakers, pipettes, pipette controllers, tubings, flow indicators, hose connectors, hose clamps, valves, rapid couplings, threaded fittings, protective equipment, accessories for laboratory equipment

Table of contents pumps



- 6 – 14 Container pumps
- 15 – 23 Barrel pumps
- 15 – 17 Barrel pumps for acids and alkalis
- 18 – 23 Barrel pumps for flammable liquids
- 25 – 27 Accessories for pumps
- 26 – 27 Barrel connectors, thread adapters
- 31 Siphon
- 32 – 39 Electric pumps
- 38 – 39 Double-diaphragm pumps, magnetic centrifugal pumps,
Airjet compressor
- 40 – 49 Stopcocks, spigots, ball valves, IBC discharge valves
- 50 – 55 Accessories for pumps





Pumps

Pumps and stopcocks

Fill off liquids – but do it safely

Safety is the top priority

Dangerous liquids must never be filled off by directly pouring them out. Even the use of a funnel does not provide the required degree of safety when bottling dangerous liquids.

- ▶ Increased accident risk by slipping on dirty floors.
- ▶ Skin diseases or poisoning by spilt chemicals.
- ▶ Health hazard from harmful vapours.



Safety during bottling must be the number one priority – for your own personal protection!
This means that purchasing a suitable pump for filling off hazardous

liquids is an investment in the safety and health of your employees which pays for itself in a very short time.

Choosing the right pump

Apart from the size and type of the container, the required pump capacity and the suitability of the pump for the particular medium are important considerations for choosing the right pump. The pump does not only have to be resistant to the medium to be bottled, but specific occupational safety and environmental protection regulations must also be considered.

Pump capacity

Electric pumps are the first choice for filling off large quantities at a fixed location. Their higher pumping capacity saves times and requires less manual effort. However, the purchase of an expensive electric barrel pump does not always pay for itself; there is often no on-site mains supply, e.g. in the open air, during assembly or in the equipment storage facility. Manual pumps are an interesting alternative to electric pumps for filling off small quantities due to their independence from a power supply and because they mean value for money. Bürkle offers a wide range of pumping devices for manually removing liquids from containers, canisters, drums and tanks.

Container size and container type

Pumps that work according to the excess pressure principle are suitable for filling off the required quantities from canisters and closed containers. Air is pumped into the container using a pumping ball or pumping piston. This creates excess pressure in the container and the liquid is transported out via the immersion tube.

Barrel pumps are suitable for larger barrels and open containers. They draw in the liquid and then eject it. This family of pumps is characterised by their robust construction with a good pumping capacity and simple handling. Different immersion tube lengths mean that the pumps fit all the usual commercially available containers. Low-mounted suction valves ensure that almost all the residual liquid is removed.



Container connections

In contrast to metal drums, which usually have an R2" fine thread, there are no standard connection threads for plastic drums. There are basically two different ways of attaching the pump to the drum or container. On the one hand, the pump can be screwed onto the existing container thread using a barrel screw joint, possibly in combination with an adapter. On the other hand, universal solutions such as conical drum stoppers can be used.

Materials

The most suitable pumps are robust industrial pumps made from top-quality materials such as polypropylene (PP) for acids and alkalis, or stainless steel AISI 304 (1.4301) for flammable liquids. We always recommend the use of PTFE seals. Always check that the material is resistant to the medium to be pumped.

In many cases, a check against the chemical resistance list will help.



Any questions?

We will be happy to advise you. Talk to us - telephone +49 7635 82795-0, or send an email to info@buerkle.de.



More information about
 „Fill off liquids - but do it safely“:
www.buerkle.de/en/knowhow/fill-off-liquids-but-do-it-safely

OTAL® liquid transfer pumps | filling off liquids quickly, safely and cleanly

The OTAL® pump program has been on the market for 70 years. The pumps are popular and appreciated thanks to their easy handling in daily use.

Thanks to the simple stopper system, OTAL® pumps can be used for all common containers. The OTAL® Mini allows even very small containers to be filled. Only the tube comes into contact with the liquid when OTAL® pumps are used, so that a great deal of liquid can be filled off using the tube materials PP, PVDF and stainless steel AISI 304 (1.4301). The different tube diameters make individual adjustments to required transfer volumes possible.

The OTAL® foot pump has another great advantage, particularly when filling aggressive media. It is designed so that both hands are free during the pumping process.

- ▶ Optionally available as a foot or hand pump
- ▶ Universal bungs for container openings of 30 – 70 mm diameter
- ▶ Tubes made of PE, PP, PVDF or stainless steel AISI 304 (1.4301) for different liquids



The bung has to fit!

Filling with the proven OTAL® pumps is particularly easy as the liquid is forced out of the container by the excess air pressure. The liquid flow is steady, without pulsating. However, it is important that the connection between the pump and the container is airtight. This is ensured by the universal bung made of soft PVC.

The universal bung consists of 3 parts, a conical centre (1) and 2 conical sleeves (2 and 3) which can be moved up and down the conical centre. This means that it is possible to obtain an airtight seal between OTAL® pumps and container openings with a diameter of 30 to 70 mm.



Instructions for use and safety information must be complied with. Protective clothing must be worn. See pages 51 - 55.

OTAL® disposable pumps



Use

1. Push the delivery tube into the universal plug and attach the pump ball.
2. Shorten the delivery tube, cutting it off at a slight angle.
3. Build up pressure with the pump ball and transfer the liquid.
4. To replace the delivery tube, cut off the tube directly below the plug.
5. Dispose of the lower end of the tube directly. Pull the upper end out of the universal plug.
6. Insert a new tube.

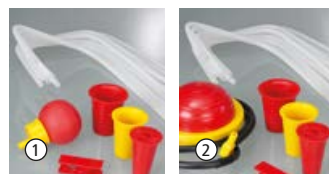

OTAL pump with disposable delivery tube made of PE, for single use. In OTAL pumps the medium being transferred comes in contact only with the delivery tube. The disposable delivery tube can be replaced quickly and easily after use. There is a danger with reusable pumps that the liquid being transferred will be contaminated by the pump, especially if the pump is used for different media or containers and it is not properly cleaned before the change. A space-saving container pump is specially designed for single use, thereby completely eliminating time-consuming and cost-intensive cleaning as well as contamination. The delivery tube of the liquid transfer pump is made of a single piece and can easily be shortened to the respective container height using the cutter included with delivery. This offers maximum flexibility and guarantees good emptying of small remaining amounts from the container. The discharge of the delivery tube can also be shortened if necessary.

The disposable pump is ideal when special purity is important or if cleaning is difficult or not possible at all.

- ▶ Disposable delivery tube made of PE, can be reordered in pack of 10
- ▶ Disposable delivery tubes, can be cut to length individually
- ▶ With universal plug made of soft PVC, for container openings of Ø 30-70 mm
- ▶ Scope of delivery: Pump ball, universal plug, cutter and 10 disposable delivery tubes

① OTAL® disposable hand pump			
Pump capacity approx. l/min	Tube Ø mm	Immersion depth cm	Item no.
14	12	90	5005-8012 N4
② OTAL® disposable foot pump			
Pump capacity approx. l/min	Tube Ø mm	Immersion depth cm	Item no.
14	12	90	5000-8012 N4
Accessories			
Description			Item no.
Delivery tubes PE for OTAL® disposable pumps, 10 pieces			5000-8000 N4

OTAL® hand pumps | to fit most commercial storage drums

The telescopic immersion tube adapts itself to the container height on insertion. This ensures good removal of residual liquid and means that the hand pump can be used with different containers.

- ▶ Particularly compact, space-saving hand pump
- ▶ Good pump capacity
- ▶ With universal bungs made of soft PVC, for container openings of 30–70 mm Ø

⚠ Attention! Make sure to pay attention to the "List of Chemical Resistance"!



OTAL® hand pumps | to fit most commercial storage drums

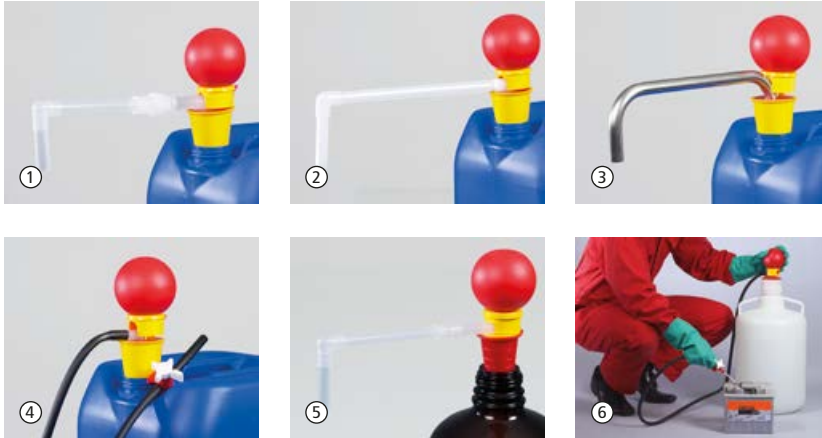

① OTAL® hand pump made of PP

OTAL® hand pumps with PP delivery tubes, resistant to weak acids, alkalis and detergents.

② OTAL® hand pump made of PVDF

OTAL® hand pump with PVDF delivery tubes, particularly suitable for acids and alkalis, not for heavily oxidising acids and alkalis. With its special material properties, PVDF has an even better chemical resistance than PP. Resistant to chlorine bleach.

③ OTAL® hand pump made of stainless steel

OTAL® hand pump with delivery tubes made of stainless steel AISI 304 (1.4301) for liquids that are not easily combustible in Hazard Category AIII (VbF). The OTAL® PP or PVDF hand pump should be used for caustic media.

④ OTAL® hand pump with hose and stopcock

OTAL® hand pump with hose and tap with discharge hose with a length of 1.5 m made of PVC and PP/PE stopcock, delivery tube made of PP. The discharge hose is particularly suited to fill distant containers.

⑤ OTAL® mini pump made of PP

OTAL® PP mini pump with delivery tubes made of PP and universal bungs made of soft PVC.

- ▶ For small containers, ideal for containers up to 10 litres
- ▶ With universal bungs for container openings of 20–36 mm Ø

⑥ OTAL® battery-pump

OTAL® pump for safe filling of car batteries with acid or distilled water.

- ▶ With hose shutoff valve
- ▶ With dosing tip for precise filling

OTAL® hand pump						
	Pump capacity approx. l/min	Tube Ø mm	Delivery tube material	Immersion depth cm	Item no.	
①	14	12	PP	70	5005-1200	N4
①	20	15	PP	70	5005-1500	N4
①	26	18	PP	70	5005-1800	N4
②	20	16	PVDF	70	5005-3000	N4

OTAL® hand pump						
	Pump capacity approx. l/min	Tube Ø mm	Delivery tube material	Immersion depth cm	Item no.	
③	26	18	AISI 304	90	5005-4000	N4
④	12	12	PP/PVC	70	5005-6000	N4
⑤	4	10	PP	45	5005-1000	N4
⑥	5	12	PP/PVC	70	5005-7000	N4

OTAL® foot pumps | high performance, sturdy, for industrial use



The telescopic immersion tube adapts itself to the container height on insertion of the foot pump. This ensures good removal of residual liquid and means that the foot pump can be used with different containers.

- ▶ Simple handling: Both hands remain free for filling
- ▶ Very good pump capacity due to large volume foot bellows
- ▶ With universal bungs made of soft PVC, for container openings of 30–70 mm Ø

 Attention! Make sure to pay attention to the "List of Chemical Resistance"!

OTAL® foot pumps | high performance, sturdy, for industrial use



① OTAL® foot pump made of PP

OTAL® foot pumps with delivery tubes made of PP, resistant to weak acids, alkalis and detergents.

② OTAL® foot pump made of PVDF

OTAL® foot pump with delivery tubes made of PVDF, particularly for acids and alkalis, not for heavily oxidising acids and alkalis. Resistant to chlorine bleach. With its special material properties, PVDF has an even better chemical resistance than PP.

③ OTAL® foot pump made of stainless steel

OTAL® foot pump made of stainless steel AISI 304 (1.4301), with delivery tubes made of stainless steel for liquids that are not easily combustible in Hazard Category AIII (VbF).

④ OTAL® foot pump with hose and stopcock

OTAL® foot pump with hose and tap with delivery tubes made of PP and a 1.5 m discharge hose made of PVC with stopcock made of PP/PE Ø 10 mm.



⑤ OTAL® battery-pump

OTAL® pump for safe filling of car batteries with acid or distilled water.

① OTAL® foot pump made of PP



Pump capacity approx. l/min	Tube Ø mm	Delivery tube material	Immersion depth cm	Item no.
20	15	PP	70	5000-1500 N4
26	18	PP	70	5000-1800 N4
30	22	PP	90	5000-2200 N4

Pump capacity approx. l/min	Tube Ø mm	Delivery tube material	Immersion depth cm	Item no.
② 20	16	PVDF	70	5000-4016 N4
③ 26	18	AISI 304	90	5000-5018 N4
④ 12	12	PP/PVC	70	5000-3012 N4
⑤ 5	12	PP/PVC	70	5005-7000 N4
⑤ 5	12	PP/PVC	70	5000-6000 N4

Pump-it® container pump

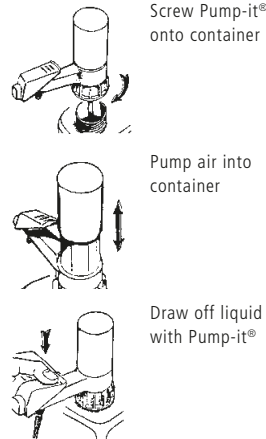

Pump-it® canister pumps are designed for quickly and cleanly emptying canisters and small barrels up to 60 l. The hand pump is used to create excess pressure that forces the liquid out of the canister. Pump-it® is suitable for weak acids, alkalis and petrochemicals.

- ▶ Medium-contacting parts made of PP, PE and FKM
- ▶ Pump threads suitable for container threads 64 mm Ø (BSI)
- ▶ Exact dosing, no drips
- ▶ Container completely emptied, thanks to stepless length adjustment of immersion tube

⚠ Not suitable for hydrochloric acid! Make sure to pay attention to the "List of Chemical Resistance"!

Pump-it® container pump

Immersion depth cm	Pump capacity approx. l/min	Item no.
100	8	5201-1000 N4

Accessories

Description	Item no.
Adapter set Pump-it® consisting of: 0600-3002, -3003, -3004, -1014, -1016	5201-0030 N4
Thread adapters PP outer/outer 2" coarse thread Mauser - 64 mm (BSI)	0600-3004 N4
Thread adapters PP outer/outer 2" coarse thread Tri-Sure - 64 mm (BSI)	0600-3002 N4
Thread adapters PP outer/outer 2" BSP - 64 mm (BSI)	0600-3003 N4
Thread adapters PP outer/inner 64 mm (BSI) - DIN 60	0600-1014 N4
Thread adapters PP outer/inner 64 mm (BSI) - DIN 51	0600-1016 N4
Thread adapters PP outer/inner 64 mm (BSI) - DIN 61	0600-1013 N4
Thread adapters PP outer/inner 64 mm (BSI) - DIN 71	0600-1001 N4

For more adapters, see page 27

Adapter set Pump-it®



Thread adapter set for Pump-it® canister pump consisting of:

- ▶ Adapter outer/outer, 2" coarse Mauser - 64 mm (BSI), green
- ▶ Adapter outer/outer, 2" coarse Tri-Sure - 64 mm (BSI), brown
- ▶ Adapter outer/outer, 2" BSP - 64 mm (BSI), blue
- ▶ Adapter outer/inner, 64 mm (BSI) - DIN 60, black
- ▶ Adapter outer/inner, 64 mm (BSI) - DIN 51, black

Adapter set Pump-it®

Item no.	
5201-0030	N4

For more adapters, see page 27

PumpMaster container pumps | flexible, for universal use

The manual pressure pump is ideally suited for drawing off, decanting and emptying canisters and barrels. The hand pump is used to create excess pressure that forces the liquid out of the container. The stopcock also allows extraction of small quantities of liquid. The PumpMaster container pump is mounted on the container using a flexible stopper with a variable and adjustable diameter. No special thread adapters are required. PumpMaster fits all commercial container openings with a diameter from 46.5 mm to 60 mm. The immersion tube has a length of 95 cm and it can be shortened depending on the size of the container.

► Complete with three bungs in different sizes

! Not suitable for hydrochloric acid! Make sure to pay attention to the "List of Chemical Resistance"!

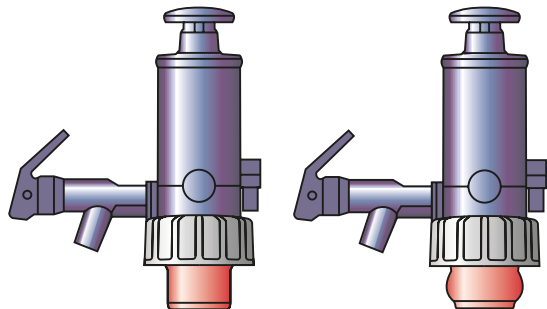

PumpMaster canister barrel pump stopper released

PumpMaster canister barrel pump stopper expanded

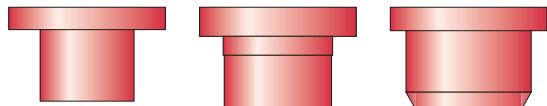

Various stoppers for PumpMaster

PumpMaster container pump for petrochemical liquids

Gaskets	Material	Colour	Pump capacity approx. l/min	Immersion depth cm	Item no.
NBR	PP	blue grey	8	95	5202-3000 N4

Accessories

Description	Item no.
Discharge hose with shut-off valve for PumpMaster for petrochemical liquids	5202-3001 N4

PumpMaster container pump for non-aggressive liquids

Gaskets	Material	Colour	Pump capacity approx. l/min	Immersion depth cm	Item no.
EPDM	PP	red	8	95	5202-2000 N4

Accessories

Description	Item no.
Discharge hose with shut-off valve for PumpMaster for aqueous liquids	5202-2001 N4

PumpMaster for acids and chemical liquids

Gaskets	Material	Colour	Pump capacity approx. l/min	Immersion depth cm	Item no.
FKM	PP	green	8	95	5202-1000 N4

Accessories

Description	Item no.
Discharge hose with shut-off valve for PumpMaster for acids and chemical liquids	5202-1001 N4

Dosing pumps Dosi-Pump

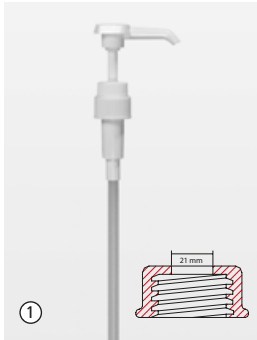

Dosi-Pump 4 ml
Standard dosage approx.
4 ml per stroke.



Dosi-Pump 30 ml
Standard dosage approx.
30 ml per stroke.



**Dosi-Pump 30 ml,
fixed feeding tube**
Standard dosage approx.
30 ml per stroke, the
pump has a fixed feeding
tube.

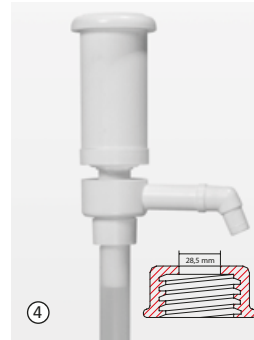

**Dosi-Pump 100 ml,
fixed feeding tube**
Standard dosage approx.
100 ml per stroke, the
pump has a fixed feeding
tube.

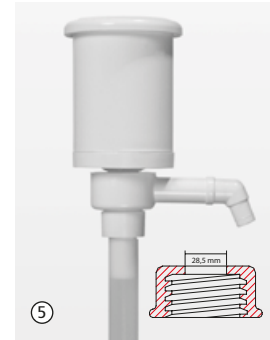

**Dosi-Pump 250 ml,
fixed feeding tube**
Standard dosage approx.
250 ml per stroke, the
pump has a fixed feeding
tube.

Dosing pumps suitable for barrels, canisters, carboys or bottles, for dosing liquids of different viscosities. Dosing pumps are mounted by you in your existing container closure (see the locating bore table). To do this, a suitable hole is drilled in the cap. Then the pump is inserted through the hole and screwed in place from below.

A matching container connection is not included in the scope of delivery.

- ▶ Medium-contacting parts made of PP, PE and stainless steel

Dosing pumps Dosi-Pump



	Stroke approx. ml	Drillhole dia. mm	Immersion depth cm	Item no.
①	4	21	25	5607-1004 N3
②	30	28.5	38.5	5607-2030 N3
③	30	22	33.5	5607-3030 N3
④	100	28.5	29.5	5607-4100 N3
⑤	250	28.5	41.5	5607-5250 N3



PTFE barrel pumps Ultrapure



Due to the high chemical resistance of the medium-contacting parts made of PTFE and FEP, even liquids which attack conventional materials such as PP or PVC can now be safely transferred (except for elemental fluorine) with this barrel pump.

The barrel pump is also suitable for transferring ultra-pure liquids. The stopcock prevents hazardous vapours from escaping, and stops dripping after transfer.

Barrel pump with rigid discharge tube with stopcock made of PTFE.

Barrel pump with flexible discharge hose made of PTFE, length of 1.2 m and stopcock made of PVDF.

- ▶ Immersion tube Ø 32 mm
- ▶ All valves are made of solid PTFE/PVDF
- ▶ Top quality – 3 years' warranty
- ▶ Barrel screw joints for commercially available containers available as accessories

PTFE barrel pump Ultrapure - discharge tube

Immersion depth cm	Pump capacity ml per stroke	Item no.
40	180	5606-0400 N4
60	270	5606-0600 N4
95	400	5606-1000 N4

PTFE barrel pump Ultrapure - discharge hose

Immersion depth cm	Pump capacity ml per stroke	Item no.
40	180	5606-0401 N4
60	270	5606-0601 N4
95	400	5606-1001 N4

Accessories

Description	Item no.
PP barrel screw joint, R 2", steel fine outer thread	5600-3130 N4
PP barrel screw joint, Mauser 2", coarse outer thread	5600-3170 N4
PP barrel screw joint, Tri-Sure, coarse outer thread	5600-3180 N4
Universal thread adapter/AISI 304, Ø 48-75 mm, G2" connector thread	5601-0120 N4
Drum holder for placing filling containers, AISI 304	5618-0200 N4

PP barrel pumps | robust industrial quality

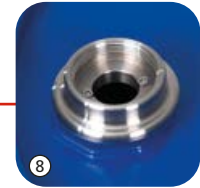
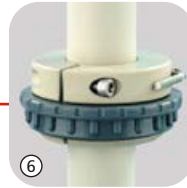

Barrel pumps made of polypropylene allow a fast transfer of liquids from barrels, canisters and tanks. The good chemical resistance of PP allows acids, alkalis and aggressive detergents to be transferred. The low-mounted non-return valve of the barrel pump and the immersion depth that can be steplessly adjusted using the barrel screw joints ensure good removal of residual liquid. The barrel screw joint fastens the barrel's pump securely to the barrel. Barrel screw joints and thread adapters for commercially available containers are available as optional accessories.

! Attention! Make sure to pay attention to the "List of Chemical Resistance"!

PP barrel pumps | robust industrial quality



PP barrel pump - discharge tube

PP barrel pump with rigid discharge tube.

PP barrel pump - discharge hose/stopcock

PP barrel pump with flexible discharge hose made of PVC, length of 1.2 m and stopcock.

- ▶ Seals made of PTFE
- ▶ Immersion tube Ø 32 mm
- ▶ Capacity up to approx. 12 l/min
- ▶ For barrels and tanks of 30–1000 litres



① PP barrel pump - discharge tube

Immersion depth cm	Pump capacity ml per stroke	Total length cm	Item no.
50	200	60	5600-0501 N4
65	230	74	5600-0651 N4
80	260	90	5600-0801 N4
100	300	109	5600-1001 N4
125	300	134	5600-1251 N4
150	300	159	5600-1501 N4

② PP barrel pump - discharge hose/stopcock

Immersion depth cm	Pump capacity ml per stroke	Total length cm	Item no.
50	200	60	5600-0502 N4
65	230	74	5600-0652 N4
80	260	90	5600-0802 N4
100	300	109	5600-1002 N4
125	300	134	5600-1252 N4
150	300	159	5600-1502 N4

Accessories

Description	Item no.
③ PP barrel screw joint, R 2", steel fine outer thread	5600-3130 N4
④ PP barrel screw joint, Mauser 2", coarse outer thread	5600-3170 N4
⑤ PP barrel screw joint, Tri-Sure, coarse outer thread	5600-3180 N4

Accessories

Description	Item no.
⑥ Container screw joint	5600-3140 N4
⑦ PVC barrel plug, dia. 40–70 mm (not for EX zone)	5600-3150 N4
Discharge hose 1.2 m PVC with stopcock for PP barrel pump	5600-0100 N4
⑧ Universal thread adapter AISI 304, Ø 48-75 mm, G2" connector thread	5601-0120 N4
Drain safety stand (see page 50)	5618-1000 N4
Drum holder for placing filling containers, AISI 304	5618-0200 N4

Stainless Steel Barrel Pump | for flammable liquids



The Bürkle barrel pump made of stainless steel AISI 304 (1.4301) is suitable for filling combustible and easily flammable liquids. The barrel pump can conduct electricity and therefore fulfills the requirements for handling flammable liquids in combination with the accessory antistatic set.

The PTFE gaskets ensure long-term and maintenance-free use. Pumping capacity approx. 9–22 l/min, dependent on pump length.

The wide range of accessories makes it possible to adapt the pump to very different requirements.

Not suitable for acetone!

When withdrawing flammable liquids, the barrel and pump have to be grounded! Use Anti-static set!

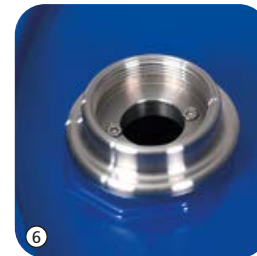

Stainless Steel Barrel Pump | for flammable liquids



Stainless steel barrel pump - discharge tube

Barrel pump made of stainless steel with discharge tube.

- ▶ Removable discharge tube
- ▶ Immersion tube Ø 32 mm

Stainless steel barrel pump - discharge hose/stopcock

Barrel pump stainless steel with discharge hose and stopcock made of stainless steel and PTFE, can conduct electricity.

- ▶ Immersion tube Ø 32 mm
- ▶ Removable hose, 1.2 m in length
- ▶ Ball valve made of stainless steel NW 8 mm
- ▶ Discharge nozzle Ø 12.8 mm

① Stainless steel barrel pump - discharge tube

Immersion depth cm	Total length cm	Pump capacity ml per stroke	Item no.
36	48	190	5601-0400 N4
57	69	330	5601-0500 N4
91	103	540	5601-0800 N4

② Stainless steel barrel pump - discharge hose/stopcock

Immersion depth cm	Total length cm	Pump capacity ml per stroke	Item no.
36	48	190	5601-0401 N4
57	69	330	5601-0501 N4
91	103	540	5601-0801 N4

Accessories

Description	Item no.
③ Anti-static set	5602-1000 N4
④ Brass barrel screw joint R 2" steel fine outer thread	5601-0100 N4

Accessories

Description	Item no.
⑤ Gastight barrel connector R 2" steel fine outer thread	5601-0130 N4
Discharge hose 1.2 m with stainless steel/PTFE stopcock	5601-0090 N4
Discharge tube for stainless steel barrel pump	5601-0080 N4
PVC barrel plug, dia. 40–70 mm (not for EX zone)	5600-3150 N4
⑥ Universal thread adapter AISI 304, Ø 48-75 mm, G2" connector thread	5601-0120 N4
Drain safety stand (see page 50)	5618-1000 N4
Drum holder for placing filling containers, AISI 304	5618-0200 N4
PP barrel screw joint, R 2", steel fine outer thread	5600-3130 N4
PP barrel screw joint, Mauser 2", coarse outer thread	5600-3170 N4
PP barrel screw joint, Tri-Sure, coarse outer thread	5600-3180 N4
Universal barrel spanner	5690-0090 N4
Casual style safety goggles	2502-2010 N3



Solvent pump foot operated



Solvent pump foot operated for filling off high purity liquids such as solvents.

Pouring flammable liquids

All medium-contacting parts are made of stainless steel AISI 304 (1.4301) and PTFE. The Bürkle anti-static set can be used to ground the pump for dispensing flammable liquids so that no electrostatic charge forms.

Protection against hazardous vapours

Due to the barrel screw joint and the stopcock, the container and the pump can be hermetically sealed. So that no dangerous vapours can escape after dispensing. This protects both health and the environment.

Sturdy and practical design

The solid, durable industrial version of the solvent pump ensures a long service life. The pump works according to the overpressure principle. An excess pressure is built up in the tank with the foot actuator, forcing the liquid out of the container. Easy foot operation of the pump with foot actuator leaves both hands free for dispensing. The air hose can be quickly and easily connected and disconnected with the practical clip connection.

- ▶ Immersion tube can be steplessly adjusted to the barrel depth
- ▶ For barrels up to 220 litres
- ▶ Suitable for steel barrels with R 2" thread
- ▶ Thread adapter for commercially available containers and air filters for ultra-pure drawing-off available as accessory

⚠ When withdrawing flammable liquids, the barrel and pump have to be grounded!
Use Anti-static set!



Solvent pump foot operated - discharge hose/stopcock

Immersion depth cm	Connector thread	Pump capacity approx. l/min	Item no.
95	2"	20	5603-3000 N4

Solvent pump foot operated - discharge tube

Immersion depth cm	Connector thread	Pump capacity approx. l/min	Item no.
95	2"	20	5603-1100 N4

Accessories

Description	Item no.
Anti-static set	5602-1000 N4

Accessories

Description	Item no.
Air filters for solvent pump, filter class F5, 10 pieces	0006-6009 N4

Solvent pump hand operated



Hand-operated solvent pump for contaminationfree removal of organic solvents and flavouring agents. The hand pump works according to the overpressure principle. An excess pressure is built up in the tank with the pump ball, forcing the liquid out of the container.

Pouring flammable liquids

All medium-contacting parts are made of stainless steel AISI 304 (1.4301) and PTFE. The Bürkle anti-static set can be used to ground the pump for dispensing flammable liquids so that no electrostatic charge forms.

Gastight version

The pump can be completely closed off with the two ball valves so that no dangerous vapours can escape after dispensing.

Suitable for different containers

The hand pump is suitable for containers up to 60 litres. The solvent pump for tinfoil canisters has a connector thread for pull-out spouts.

- ▶ Medium-contacting parts made of stainless steel AISI 304 (1.4301) and PTFE
- ▶ Rigid discharge tube with stopcock made of stainless steel/PTFE
- ▶ Suitable for containers with R 2" thread
- ▶ Thread adapter for commercially available containers available as accessory

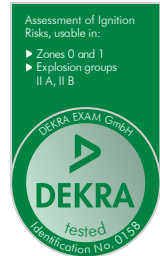

Solvent pump for tin-foil canisters fits on pull-out spouts



Anti-static set

! When withdrawing flammable liquids, the barrel and pump have to be grounded! Use Anti-static set!

Solvent pump hand operated

Immersion depth cm	Connector thread	Pump capacity approx. l/min	Item no.
60	2"	10	5603-1000 N4



Solvent pump hand operated, for tin-foil canisters

Immersion depth cm	Connector thread	Pump capacity approx. l/min	Item no.
60	for pull-out spout with Ø 35 mm	10	5603-2000 N4



Accessories

Description	Item no.
Anti-static set	5602-1000 N4

Withdrawal system for solvents



The withdrawal system can be used to dispense high-purity liquids quickly and without complications. An excess pressure is produced in the container with pressurised gas (compressed air or nitrogen), thereby pumping the liquid out of the tank. The advantage of operation using pressure gas is that the user can extract even large amounts without effort while having both hands free to dispense the solvent. In this way, large amounts of hazardous media such as acetone, ethanol and methanol, etc. can also be safely dispensed and accurately metered using the stop cock. For use with media sensitive to oxygen or for ultra-pure media, operation with an inert gas (e.g. nitrogen) is possible.

The barrel screw connection and shut-off valves seal off the barrel and pump hermetically. This means that no vapours containing solvents can escape after dispensing, thereby protecting users' health and the environment.

The transportable withdrawal system makes it possible to work flexibly. It consists of a barrel pump and attachable pressure regulating unit that adjusts the input pressure and offers additional protection against misuse. A pressure gauge allows for a visual check of the input pressure.

The pump can easily be fastened onto the container with a barrel screw connection. The compressed air or nitrogen connection (3-10 bar) can be provided via a mobile or stationary compressed air supply. The withdrawal system for solvents offers a secure and accurate way to dispense different solvents in laboratory and industrial applications.

⚠ Caution! When working with combustible liquids, the tank, pump and pressure regulating unit must be earthed! Use antistatic set in addition for pump!

Withdrawal system for solvents



The withdrawal system for solvents with discharge tube has a barrel pump with fixed discharge tube. The steplessly adjustable immersion tube of the barrel pump can be adjusted to the respective tank. With barrel screw connection for steel barrels with R 2" thread. Can be adjusted for standard commercial tanks with thread adapters.

In the withdrawal system for solvents with discharge hose, the barrel pump has a flexible discharge hose. The hose makes it possible to dispense the relevant solvent into tanks that are located some distance away and meter it accurately. With barrel screw connection for steel barrels with R 2" thread. Can be adjusted for standard commercial tanks with thread adapters.



- ▶ Flexible connection options, operation with compressed air or inert gas (e.g. nitrogen)
- ▶ Parts in contact with medium made of stainless steel (1.4301) and PTFE
- ▶ Including transport stands, earthing cable for pressure regulating unit, connecting hose, key and adapter for compressed air supply
- ▶ Compressed air supply adapter (G 1/4"): 1x coupling connector NW 7.2 mm, 1x hose nozzle for internal Ø 6 mm, 1 x hose nozzle for internal Ø 8 mm
- ▶ For UN tanks and barrels (test pressure at least 150 kpa)
- ▶ The device complies with the requirements of the Pressure Equipment Directive 2014/68/EU

① Withdrawal system for solvents with discharge tube



Immersion depth cm	Purpose	Pump capacity approx. l/min	Item no.
60	for tanks up to approx. 60 l	10	5603-5001 N4
95	for barrels up to approx. 220 l	10	5603-5003 N4

② Withdrawal system for solvents with discharge hose



Immersion depth cm	Purpose	Pump capacity approx. l/min	Item no.
95	for barrels up to approx. 220 l	10	5603-5004 N4

📦 Accessories

Description	Item no.
Anti-static set	5602-1000 N4

Mini solvent pump | reliable filling of small quantities

The Mini solvent pump is a high-quality hand pump for small containers such as bottles, canisters and tanks up to about 10 litres. For reliable filling and dosing of solvents and readily flammable liquids.

Simple principle - highly effective

The hand pump works according to the excess pressure principle. In this way only the hose, pumping tube and discharge come in contact with the liquid being filled. To ensure safety, a pressure relief valve protects the solvent pump against excessive pressure build-up.

High-quality materials

All parts of this hand pump in contact with medium are manufactured from PTFE and stainless steel AISI 304 (1.4301), AISI 316L (1.4404). The Mini solvent pump is therefore especially well suited for use with high-purity liquids and readily flammable media.

Filling in hazardous zones

The grounding cable included with delivery can easily be connected to the solvent pump with a bunch plug, thus diverting electrostatic charges so that flammable media can be filled safely.

Flexible applications

The hand pump has a GL 45 standard connecting thread. With the appropriate thread adapters (accessories), however, it can easily be adapted to containers with thread sizes S 40, GL 38 or GL 32.

Precise removal of liquids

The self-closing discharge (with auto-stop function) of the Mini solvent pump ensures absolutely precise filling. A hose can optionally be fastened onto the discharge spout (internal Ø 6 mm).

Well balanced

The Mini solvent pump is very well balanced, which makes it possible to fill without tipping, even from very small containers.

Sturdiness for long service life

Thanks to its sturdy design and high-quality materials, the Mini solvent pump consistently ensures neat and reliable filling throughout its long service life, easily and conveniently.



- ▶ Ideal for 1–5 l containers
- ▶ Connecting thread GL 45
- ▶ Parts in contact with medium made of PTFE and stainless steel AISI 304 (1.4301), AISI 316L (1.4404)
- ▶ PTFE hose (6x8 mm) 0.4 m
- ▶ Including grounding cable 2 m
- ▶ Adapter available as accessory for S 40, GL 38 and GL 32

Mini solvent pump

Pump capacity approx. l/min	Connector thread	Item no.
1.8	GL 45	5603-4000 N4

Accessories

Description	Item no.
Thread adapter for Mini solvent pump, PTFE, GL 45 - S 40	0006-4000 N4
Thread adapter for Mini solvent pump, PTFE, GL 45 - GL 38	0006-4002 N4
Thread adapter for Mini solvent pump, PTFE, GL 45 - GL 32	0006-4003 N4
Hose cutter	0006-9506 N3
Glass sampling bottle 1000 ml, GL 45	5314-0100 N3
Suction hose PTFE on roll 6 x 8 mm, roll with 5 m	8804-0608 N3

Anti-static set | prevents electrostatic build-up

Conductive containers are connected with the red cable, the black cable makes the earth connection (water pipe, etc.)

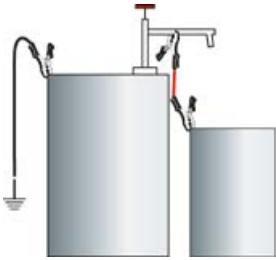

Safety Plus: The bare copper wire ensures earthing when pouring into non-conductive containers



When decanting flammable liquids without the machines and containers involved in the process being sufficiently earthed, electrostatic build-up can occur, which for many substances can result in fire or an explosion. Bürkle's Anti-static set ensures easy and reliable earthing. The Anti-static set consists of three colour-coded connecting copper cables with clamps in a handy plastic case.

Anti-static set

Item no.
5602-1000



N4

Barrel screw joints



Barrel screw joint made of nickel-plated brass for barrel pump stainless steel. Prevents electro-static charge in combination with the Anti-static set. For the safe transfer of flammable and easily flammable liquids. For containers with R 2" steel fine thread inside.

Brass barrel screw joint

Thread	Tube Ø mm	Item no.	
R 2" steel fine outer thread	32	5601-0100	N4



The gas tight barrel screw joint prevents hazardous gases from escaping from the barrel. R 2" steel barrel thread, non-return valve with connection 1/8". Nickel-plated brass, seals made of FKM.

Gastight barrel connector

Thread	Tube Ø mm	Item no.	
R 2" steel fine outer thread	32	5601-0130	N4



Universal thread adapter for nearly all drums and other containers with opening of 48–75 mm in diameter, regardless of the respective thread. The thread adapter can be mounted quickly and easily with clamping screws and can be used for different container openings.

With G2" connector thread for Bürkle drum screw connections and pumps with immersion tube diameter up to 32 mm.

Universal thread adapter

Opening dia. mm	Tube Ø mm	Item no.	
48-75	32	5601-0120	N4



Barrel screw joint made of PP for secure connection in the barrel in three different thread models. For drawing off liquids that are not flammable.

PP barrel screw joint

Thread	Tube Ø mm	Item no.	
R 2", steel fine outer thread	32	5600-3130	N4
Mauser 2", coarse outer thread	32	5600-3170	N4
Tri-Sure, coarse outer thread	32	5600-3180	N4



Container screw joint to fasten the barrel pump in any location on the side of the container. Also for wide-necked screw caps. The screw joint 2" is screwed on from the inside using lock nut 2". (Mounting holes in the container 60 mm).

Container screw joint

Opening dia. mm	Tube Ø mm	Item no.	
60	32	5600-3140	N4



Barrel bungs made of PVC, consisting of two parts, therefore can be used for various openings with a diameter from 40–70 mm.

PVC barrel plug

Opening dia. mm	Tube Ø mm	Item no.	
40–70	32	5600-3150	N4

Thread adapters PP



We offer a broad range of thread adapters. This facilitates the secure connection of many of our pumps and discharge cocks to a variety of containers.

You will always find the correct connection thanks to the combination of different adapters.

Do you have any questions about choosing the right thread adapter? Please call us. We are glad to offer assistance.

Instructions for determining the thread can be found on page 280.

	External thread	Internal thread	Colour	Item no.
①	Tri-Sure	2" BSP	orange	0600-1006 N4
②	Mauser	2" BSP	blue	0600-1010 N4
③	Tri-Sure	Mauser	red	0600-1011 N4
④	Mauser	Tri-Sure	purple	0600-1012 N4
⑤	US drum thread	2" BSP	silver	0600-1007 N4
⑥	61 mm	2" BSP	grey	0600-1008 N4
⑦	61 mm	3" coarse	natural	0600-1009 N4
⑧	64 mm (BSI)	DIN 60	black	0600-1014 N4
⑨	64 mm (BSI)	DIN 51	black	0600-1016 N4
⑩	64 mm (BSI)	DIN 61	yellow/blue	0600-1013 N4
⑪	64 mm (BSI)	DIN 71	brown/blue	0600-1001 N4
	Internal thread		Colour	Item no.
⑫	35 mm - 2" BSP		black	0600-2004 N4
⑬	40 mm - 2" BSP		black	0600-2012 N4
⑭	51 mm - 2" BSP		green	0600-2005 N4
⑮	DIN 61 - 2" BSP		yellow	0600-2001 N4
⑯	63 mm - 2" BSP		white	0600-2006 N4
⑰	DIN 71 - 2" BSP		brown	0600-1003 N4
	External thread		Colour	Item no.
⑱	61 mm - Tri-Sure		black/orange	0600-3006 N4
⑲	61 mm - 2" BSP		black	0600-3007 N4
⑳	2" coarse Mauser - 64 mm (BSI)		green	0600-3004 N4
㉑	2" coarse Tri-Sure - 64 mm (BSI)		brown	0600-3002 N4
㉒	2" BSP - 64 mm (BSI)		blue	0600-3003 N4
㉓	Adapter set, consisting of 1, 2, 15 and 17			0600-3010 N4

Gas-tight barrel pump PP | odour-free liquid transfer

Gas-tight stainless steel pump

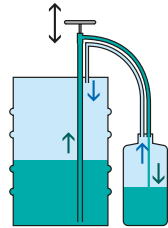

Liquid is pumped in the closed system (green). Vapours are directed back through the gas displacement line (blue)

- ▶ Medium-contacting parts PP, PE and PVC
- ▶ Steplessly extendable telescopic tube
- ▶ For barrel depths of 40–67 cm
- ▶ Two adapters for original containers



- Gas tight barrel pump with flexible discharge hose for filling off into large canisters and containers. Convenient transfer because the canister can stay on the floor. The connection cone is held onto the container.
- ▶ Parts in contact with media: Stainless steel AISI 304 (1.4301), PTFE, nickel-plated brass, PA that can conduct electricity
 - ▶ Incl. gas-tight barrel screw joints with 2" fine thread
 - ▶ For bottle openings from 16–49 mm
 - ▶ Immersion tube Ø 32 mm
 - ▶ The pump can be hermetically sealed with two ball valves

Pump has been developed in cooperation with Ludwig-Maximilians University, Munich.

Not suitable for acetone! When withdrawing flammable liquids, the barrel and pump has to be grounded! Use Anti-static set!

The gas-tight barrel pump enables odour-free transfer.

During transfer with normal pumps, it is impossible to prevent vapours escaping into the atmosphere. The gas-shuttle method avoids this. Any vapours produced are returned from the container which is to be filled to the original container via the gas-shuttle pipe. The gas pipe and the liquid pipe are additionally provided with stopcocks. Gas-tight pumps are used for substances that have a strong smell such as ammonia.

Gas-tight barrel pump PP

Model	Pump capacity ml per stroke	Item no.	
① with universal adapter 34–70 mm Ø	200	5610-1030	N4
② with 2 screw joint adapters 3/4" with lock nuts	200	5610-1040	N4

Gas-tight stainless steel barrel pump

Immersion depth cm	Total length cm	Pump capacity ml per stroke	Item no.	
57	69	330	5611-1090	N4
91	103	540	5611-0090	N4

Lever pump aluminium



Lever pump for petrochemical substances made of stable aluminium cast, valves and pistons are made of plastic (PA).

- ▶ Suitable for barrel threads M 64x4 or R 2"
- ▶ With closure device (for padlock)
- ▶ Immersion tube length 84 cm
- ▶ Supplied with hose kit, hose length 1.5 m, electrically conductive, with outlet elbow and bend protection spring

Lever pump aluminium

Pump capacity approx. l/min	Pumping height water column m	Connector thread	Item no.
25	1	M 64x4, R 2"	5627-1000 N2

Accessories

Description	Item no.
Anti-static set	5602-1000 N4

Piston pump PP



Piston pump for watery and petrochemical products. It represents value-for-money. The piston pump is attached to the barrel using a 2" - or 3/4" barrel thread. After mounting, the pump can still be rotated around its axis so that containers to be filled can be placed on the barrel lid.

- ▶ Polypropylene, polyethylene, seals made of NBR
- ▶ Pump capacity adjustable from 100, 250, 350 and 500 ml per stroke
- ▶ For containers with G 2" and G 3/4" inner thread
- ▶ Immersion tube length 84 cm

! Note the "List of Chemical Resistance"!

Piston pump PP

Item no.	
5613-0030	N4

Compact lever pump



Compact, self-priming polypropylene lever pump suitable for light acids and bases. The telescope tube for lever pump is steplessly extendable up to 100 cm, which means it can be used for barrels from 50 to 200 l.

- ▶ Polypropylene, seals made of NBR
- ▶ Pump capacity up to about 500 ml per stroke
- ▶ Discharge tube can be rotated 360°
- ▶ With integrated barrel screw connection for G2" thread

! Attention! Make sure to pay attention to the "List of Chemical Resistance"!

Compact lever pump

Immersion depth cm	Item no.
100	5613-0020 N4

Lever pump



Lever pump with galvanised steel piston rod

The lever pump is made of polypropylene with a galvanised steel piston rod and FKM seals.

Lever pump with stainless steel piston rod

The lever pump is made of polypropylene with a stainless steel piston rod made of AISI 304 (1.4301) and FKM seals.

The required quantities can be taken from barrels without great effort with this manual lever pump. Ideal for occasional use.

Applications of the lever pump: water, lubricants, light oils, water-based chemicals and light acids and caustic solutions.

- ▶ With integrated barrel screw connection for 1 1/4" and 2" fine thread
- ▶ Pump capacity 350 ml per stroke
- ▶ Immersion depth steplessly variable from 65–90 cm

Note the "List of Chemical Resistance"!

Lever pump with galvanised steel piston rod			
Colour	blue	Item no.	5613-0040 N4
Lever pump with stainless steel piston rod			
Colour	yellow	Item no.	5613-0041 N4

Siphon with stopcock | for occasional drawing off of liquids



Device for easy operation to quickly fill off watery liquids from containers higher up to containers lower down.

Works according to the siphoning principle: Liquid needs only to be primed once, therefore especially handy for complete emptying of a container.

- ▶ LDPE/PVC
- ▶ Pump capacity 9 l/min
- ▶ With robust ball valve made of PP
- ▶ Good view of medium due to transparent hoses
- ▶ Bend protection for the hose with suspension eyelet
- ▶ Cost-effective filling unit if drawing-off does not need to take place regularly

Offered also as rigid immersion tube upon request.



Siphon with stopcock

Material	Immersion depth cm	Hose inner dia. mm	Pump capacity approx. l/min	Item no.
LDPE/PVC/PP	100	15	9	5605-1000 N4



AccuOne / EnergyOne | Flexible – reliable – convenient – with the hybrid system

One pump with maximum possibilities.

Bürkle barrel pumps AccuOne and EnergyOne with the unique hybrid system ensure fast, flexible and convenient filling whenever and wherever you want. The pumps are equipped with two different power supply systems:

AccuOne, driven by a high-performance rechargeable battery or EnergyOne, with a power cable for direct connection to the electrical network.

The innovative feature: The power supply units are interchangeable!

The rechargeable battery or the power supply unit are fitted with a clip lock and are removable. They can be exchanged quickly and easily. Thus AccuOne can also be operated with the power supply cable unit and EnergyOne can be operated with the rechargeable battery. With an exchange battery as an accessory, you can also reduce the number of charging breaks.

The drive can also be disconnected quickly and easily from the pump station with a clip lock. This makes it possible to use one drive for filling at several stationary pump stations. AccuOne and EnergyOne are designed for applications in which even very small amounts of liquid can be added to small containers with narrow openings.

The touch panel features a foil keyboard sealed off against dust, dirt and water. The keyboard can be used to regulate the flow rate continuously from 0.4 l/min to 12 l/min.

In addition to the drainage elbow, a flexible drainage hose with nozzle is optionally available. The light and powerful pumps are made of high-quality materials, PP, PTFE and Hastelloy C, to ensure outstanding chemical resistance. This also makes them suitable for dispensing acids and bases. Please make note of detailed information related to chemical resistance!

Attention! Make sure to pay attention to the "List of Chemical Resistance"!

Do not use in EX area!

- ▶ Unique hybrid system – rechargeable battery and power supply unit are interchangeable
- ▶ Drive unit can be easily disconnected
- ▶ TouchPanel for precise flow regulation
- ▶ Excellent residual draining and pumping capacity
- ▶ One drive for several pump stations
- ▶ Outstanding chemical resistance



Battery can be easily disconnected



Power supply unit can be easily disconnected



Drive unit can be easily disconnected



Touch panel



Power supply unit incl. connector



Charger for battery



AccuOne barrel pump



More accessories on page 34

The barrel pump driven by rechargeable battery, AccuOne, features a unique hybrid system with complete flexibility and independence from the electrical network. A powerful light rechargeable battery with the latest next generation lithium-ion technology, without memory effect, with auto-stop function before deep discharge.

- ▶ Lithium-ion rechargeable battery
- ▶ Up to 1500 litres of delivery volume per battery charge, replacement back-up battery available
- ▶ Optionally available with rechargeable battery or power supply unit (available as accessory)
- ▶ Consisting of pump station, drive, rechargeable battery, charger and fixed discharge elbow

AccuOne barrel pump driven by rechargeable battery			
Immersion depth cm	Item no.		
50	5900-1050 N4		
70	5900-1070 N4		
100	5900-1100 N4		
Accessories			
Description	Item no.		
PP barrel screw joint, R 2", steel fine outer thread	5600-3130 N4		
PP barrel screw joint, Mauser 2", coarse outer thread	5600-3170 N4		
PP barrel screw joint, Tri-Sure, coarse outer thread	5600-3180 N4		

EnergyOne barrel pump



More accessories on page 34

The barrel pump driven by power supply unit, EnergyOne, features a unique hybrid system with complete flexibility and independence from battery charging.

- ▶ Power supply via 230 V power supply unit, international plug adapter included with delivery
- ▶ Optionally available with power supply unit or rechargeable battery (available as accessory)
- ▶ Consisting of pump station, drive, power supply unit incl. connector and fixed discharge elbow

EnergyOne barrel pump driven by power supply unit			
Immersion depth cm	Item no.		
50	5900-2050 N4		
70	5900-2070 N4		
100	5900-2100 N4		
Accessories			
Description	Item no.		
PP barrel screw joint, R 2", steel fine outer thread	5600-3130 N4		
PP barrel screw joint, Mauser 2", coarse outer thread	5600-3170 N4		
PP barrel screw joint, Tri-Sure, coarse outer thread	5600-3180 N4		



Light- and high-performance pump to transfer watery media up to 300 mPas from canisters, barrels and narrow-necked containers from 32 mm opening diameter.

- ▶ PP
- ▶ Splash-water protected motor 230 V/200 W (IP44)
- ▶ Built-in safety key as on/off switch
- ▶ Seal-less pump mechanism for acids and alkalis
- ▶ Thread connection 1" with hose connector 3/4"
- ▶ Incl. 1.5 m PVC hose 3/4", PP nozzle and wall bracket

! Attention! Make sure to pay attention to the "List of Chemical Resistance"!

Laboratory pump mains operated							
Immersion depth cm	Pump capacity approx. l/min	Pumping height water column m	Tube Ø mm	Item no.			
70	75	7	32	5700-2200 N2			
100	75	7	32	5700-4400 N2			

Accessories	
Description	Item no.
Flow meter PP 1" (see page 38)	5700-0111 N2

Accessories

Description	Item no.
① PP barrel screw joint, R 2", steel fine outer thread	5600-3130 N4
① PP barrel screw joint, Mauser 2", coarse outer thread	5600-3170 N4
① PP barrel screw joint, Tri-Sure, coarse outer thread	5600-3180 N4
② Container screw joint	5600-3140 N4
③ PVC barrel plug, dia. 40 – 70 mm (not for EX zone)	5600-3150 N4
④ Rechargeable battery without charger for Accu/EnergyOne	5900-3010 N4
⑤ Charger for battery Accu/EnergyOne	5900-3015 N4
⑥ Power supply unit incl. connectors for Accu/EnergyOne	5900-3020 N4
⑦ Drive without rechargeable battery/power supply unit	5900-3030 N4
⑧ Discharge tube	5900-3040 N4
⑨ Discharge hose 1.2 m, with nozzle (PVC, PP, AISI 304, FKM)	5900-3045 N4
⑩ Closing cap thread 3/4"	8535-0034 N3
⑪ Pump station Accu/EnergyOne, submersible length 50 cm	5900-3050 N4
⑪ Pump station Accu/EnergyOne, submersible length 70 cm	5900-3070 N4
⑪ Pump station Accu/EnergyOne, submersible length 100 cm	5900-3100 N4

Electric barrel pump Petro | for Diesel oil, class D/II fuel oil



Electric barrel pump for pumping diesel oil, Category EL fuel oil, undiluted radiator antifreeze and other liquids of Hazard Category AIII (VbF). Built-in siphon protection prevents leaks if the tube is faulty. Available for 230 V. Available with either standard filling nozzle or filling nozzle with automatic shut-off. Electronic volume readout with cumulative total and suitable for calibration (supplied uncalibrated), available as accessory.

- ▶ With manual suction pump
- ▶ VDE tested, motor with thermal protection switch
- ▶ Barrel thread M 64x4 and 2"
- ▶ Suction hose with filter 1.60 m length
- ▶ Pump hose made of Perbunan, 4 m length, with bend protection spring and pump nozzle

Not suitable for aqueous/diluted liquids!



Electric barrel pump Petro

Model	Pump capacity approx. l/min	Item no.
standard	40	5780-0040 N2
automatic	40	5780-0041 N2

Accessories

Description	Item no.
Volume readout Petro	5780-0020 N2

Volume readout Petro

Drum pump for acids and alkalis



Barrel pump for weaker acids, such as phosphoric acid, chromic acid, battery acid, citric acid, etc.

- ▶ Motor 230 V
- ▶ Pump tube PP, shaft Hastelloy C
- ▶ Thread connection 1 1/4" with hose connector 3/4"
- ▶ 2 m PVC fabric hose 3/4"
- ▶ PP pump nozzle
- ▶ PP barrel screw joint
- ▶ Pump height 19 mWS, pump capacity 85 l/min

⚠ Not suitable for hydrochloric acid! Make sure to pay attention to the "List of Chemical Resistance"!

Drum pump for acids and alkalis		
Immersion depth cm	Tube Ø mm	Item no.
100	41	5762-0100 N2
120	41	5762-0101 N2
📁 Accessories		
Description	Item no.	
Flow meter PP 1 1/4" (see page 38)	5700-0121 N2	

Drum pump for concentrated acids/alkalis



Barrel pump for highly aggressive acids and alkalis, such as sulphuric acid, nitric acid, hydrofluoric acid, sodium hypochlorite etc.

- ▶ Motor 230 V
- ▶ PVDF pump tube
- ▶ Thread connection 1 1/4" with hose connector 3/4"
- ▶ 2 m special chemical hose 3/4"
- ▶ PVDF pump nozzle
- ▶ PP barrel screw joint
- ▶ Pump height 17 mWS, pump capacity 80 l/min

⚠ Not suitable for hydrochloric acid! Make sure to pay attention to the "List of Chemical Resistance"!

Drum pump for concentrated acids/alkalis		
Immersion depth cm	Tube Ø mm	Item no.
100	41	5762-0200 N2
120	41	5762-0201 N2
📁 Accessories		
Description	Item no.	
Flow meter PVDF 1 1/4" (see page 38)	5700-0141 N2	

Drum pump for mineral oils



Barrel pump for light viscous mineral oil products, such as diesel, fuel oil, hydraulic fluid, machinery and motor oil, etc.

- ▶ Motor 230 V
- ▶ Pump tube made of aluminium
- ▶ Hose connection Alu 1"
- ▶ 2 m PVC fabric hose 1"
- ▶ Hose clips 1"
- ▶ Alu pump nozzle, PP barrel screw joint
- ▶ Medium-contacting parts made of aluminium and AISI 316 Ti (1.4571)
- ▶ Delivery pump height 19 mWS, Pump capacity 85 l/min

! Attention! Make sure to pay attention to the "List of Chemical Resistance"!

Drum pump for mineral oils



Immersion depth cm	Tube Ø mm	Item no.
100	41	5763-0100 N2

Drum pump for solvents



Barrel pump for highly flammable hydrocarbons such as ethanol, benzene, butanol, isopropanol, kerosene, methanol, etc.

- ▶ Motor 230 V
- ▶ Pump tube made of stainless steel
- ▶ Voltage balancing cable
- ▶ Hose electrically-conductive
- ▶ 2 m solvent hose 3/4"
- ▶ Brass pump nozzle
- ▶ PP barrel screw joint
- ▶ Delivery pump height 14 mWS, pump capacity 95 l/min

! Attention! Make sure to pay attention to the "List of Chemical Resistance"!

Drum pump for solvents



Immersion depth cm	Tube Ø mm	Item no.
100	41	5763-0301 N2

Flow meters



Compact electronic flow counter for electrical barrel and container pumps. For thin fluid media.

- ▶ Measuring according to the turbine wheel principle
- ▶ Counter can be calibrated depending on the medium
- ▶ Different versions for many different applications
- ▶ Automatic switch-on when flow is recognised
- ▶ Measuring accuracy $\pm 1\%$, easy recalibration
- ▶ Two 1.5 V batteries (AAA), exchangeable
- ▶ For use up to max. 10 bar (20 °C)
- ▶ Range of viscosity 0,8 – 40 mPas
- ▶ Temperature -10 °C up to +50 °C

Flow meter				
Material	Model	Measuring range l/min	Connector thread	Item no.
PP, Hastelloy C22, PTFE	for fuel oil, diesel, sod. hydroxide, etc.	5 - 120	G 1 1/4"	5700-0121 N2
PP, Hastelloy C22, PTFE	for fuel oil, diesel, sod. hydroxide, etc.	5 - 120	G 1"	5700-0111 N2
PVDF, Hastelloy C22, PTFE	for highly aggressive liquids like chlorine bleaches, nitric acid, sulfuric acid, etc.	5 - 120	G 1 1/4"	5700-0141 N2

Oil-free double-diaphragm pump



Pneumatic double-diaphragm pump to pump viscous, corrosive and abrasive liquids. Pump model 1/4". The pump is available in the materials polypropylene, PVDF and nylon. The membranes, balls and valve seats are available in Geolast, PTFE and Santoprene. Solids up to 1.6 mm \varnothing can be transported.

- ▶ Max. pump capacity 16 l/min
- ▶ Suction height dry 6 m
- ▶ Self-priming
- ▶ Operating compressed air min. 1.4 bar, max. 6.8 bar
- ▶ Max. temperature 66 °C
- ▶ Inlet side/outlet side 1/4" inner thread

Oil-free double-diaphragm pump		
Model	Material	Item no.
for water-based liquids, lubricants, mineral oil	housing PP, diaphragm. Geolast	5765-0001 N2
for corrosive liquids, inorganic acids and alkalis	housing PP, diaphragm. PTFE	5765-0002 N2
for water-based liquids, sodium hydroxide solution	housing PP, diaphragm. Santoprene	5765-0003 N2
for strong acids and alkalis, increased temperatures	housing PVDF, diaphragm. PTFE	5765-0004 N2

Magnetic centrifugal pumps



The magnetic centrifugal pumps are suitable for transferring acids, alkalis, alkaline and electroplating baths, photography chemicals as well as radioactive, sterile and highly corrosive liquids. The drive, via contact-free magnetic force transfer, requires no dynamic shaft seals and this makes a hermetically sealed pump housing possible, which means that it cannot leak.

- ▶ Seal-less
- ▶ Surrounding temperature max. 45 °C
- ▶ Operating temperature max. 60 °C
- ▶ Viscosity max. 20 mPas

Magnetic centrifugal pump 15 Watts, motor 230 V, material PP (reinforced with fibre glass), stainless steel (shaft), Rulon (bearing), FKM (seal).

- ▶ Pump capacity 1 to 12 l/min, delivery height up to 2 m
- ▶ Without thread, hose nozzle 14 mm

Magnetic centrifugal pump 29 Watts, motor 230 V, material PP (fibre glass reinforced), stainless steel, Rulon (bearing), FKM (seal), ceramics (shaft).

- ▶ Pump capacity 1 to 24 l/min, delivery pump height up to 3 m
- ▶ Suction connection / pressure connection G 3/4" outer thread (BSP)

Magnetic centrifugal pump

Model	Item no.
① 15 Watt, no thread connection, with tubing nozzle	5766-0001 N2
② 29 Watt, with R 3/4" outer thread	5766-0002 N2

AirJet Mini membrane vacuum pump



The AirJet Mini single-head membrane vacuum pump is suitable for a variety of applications in the laboratory and industry. The dry running membrane vacuum pump is able to pump, compact and evacuate 100 % oil-free, which means it does not distort results or add impurities, and can also be used as a compressor. The AirJet Mini is used to pump and evacuate air and neutral or slightly aggressive or corrosive gases and vapours.

- ▶ Weight 1.9 kg, dimensions LxWxH 164/90/141 mm
- ▶ Hose connection ID 4 mm
- ▶ Maintenance-free, environmentally friendly
- ▶ High level of gas tightness
- ▶ Very quiet with low vibrations

Attention! Make sure to pay attention to the "List of Chemical Resistance"!



① AirJet Mini membrane vacuum pump/compressor



Model	Pump capacity approx. l/min	Vacuum mbar	Pressure max. bar	Item no.
Membrane made of EPDM	6	100	2.4	5625-2000 N2
Membrane made of PTFE	5.5	160	2.5	5625-2001 N2

Accessories

Description	Item no.
② AirJet Mini fine regulation head	5625-2002 N2
③ AirJet Mini sound absorber	5625-2003 N2

StopCocks | completely water-tight, easily operated

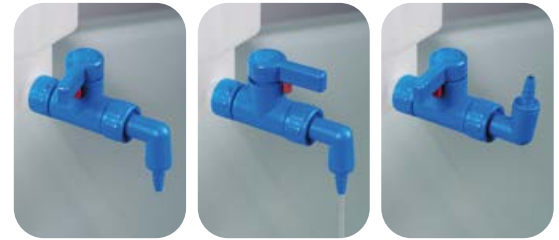

Stopcock angled

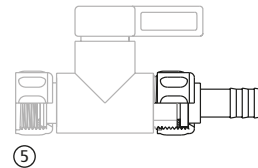
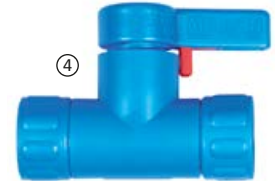
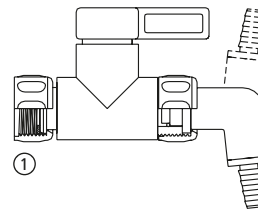

Various designs of the stopcock. Connecting thread 3/4" with union nut or external thread

The StopCock discharge cocks fit all containers with G 3/4" connection threads. Thread adapters facilitate connection of cocks to nearly all containers.

- ▶ Tight-closing for complete seal
- ▶ Especially effortless
- ▶ With connecting cap nut, guaranteed vertical position of the cock
- ▶ Pressure-resistant up to 2 bar at 20 °C (without discharge bracket and grommet)

- ▶ With discharge angle and rotatable spout preventing drips
- ▶ With tapered spout for bottles with narrow openings with a diameter from 6 to 8 mm.
- ▶ Media-contacting parts PP, PE and PTFE

Not suitable for crystallising substances!

StopCock angled

Thread, inflowing side	Thread, outflowing side	Item no.
① 3/4" inner thread cap nut	spout/nozzle	0525-1000 N4

StopCock straight-through

Thread, inflowing side	Thread, outflowing side	Item no.
② 3/4" outer thread	3/4" outer thread	0525-3000 N4
③ 3/4" inner thread cap nut	3/4" outer thread	0525-5000 N4
④ 3/4" inner thread cap nut	3/4" inner thread cap nut	0525-7000 N4

Accessories

Description	Item no.
⑤ Hose nozzle StopCock 4 mm	0525-1304 N4
Hose nozzle StopCock 6 mm	0525-1306 N4
Hose nozzle StopCock 8 mm	0525-1308 N4
Hose nozzle StopCock 10 mm	0525-1310 N4
Hose nozzle StopCock 12 mm	0525-1312 N4
Hose nozzle StopCock 16 mm	0525-1316 N4
Discharge angle	0525-1400 N4

Compact spigot



The spigot Compact for canisters and barrels captivates everyone through its compact build, which makes the valve on the canister ideal for use in refrigerators and on racks, etc. The short discharge does not protrude out over the lower edge of the container, which makes the valve a perfect choice even when space is very limited.

The discharge's specially optimised design creates an even stream of liquid with no splashing or spattering. The spigot features easy motion and a tight seal. It is screwed on with a connecting cap nut. This guarantees a vertical position of the valve and makes it possible to adjust the valve later on.

The Compact spigot fits all containers with G 3/4" connecting threads.

PP, PE and PTFE are materials that offer outstanding chemical resistance to acids and alkalis.

The Compact spigot is the ideal addition to the compact jerrycans – for perfect storage and filling when space is at a premium!

- ▶ Space-saving design
- ▶ Optimised discharge for even flow
- ▶ With connecting union nut for vertical position of the stop cock
- ▶ Tight-closing for complete seal



Compact spigot

Thread, inflowing side
3/4" inner thread cap nut

Item no.
0530-1000 N4



Compact jerrycan & StopCock set

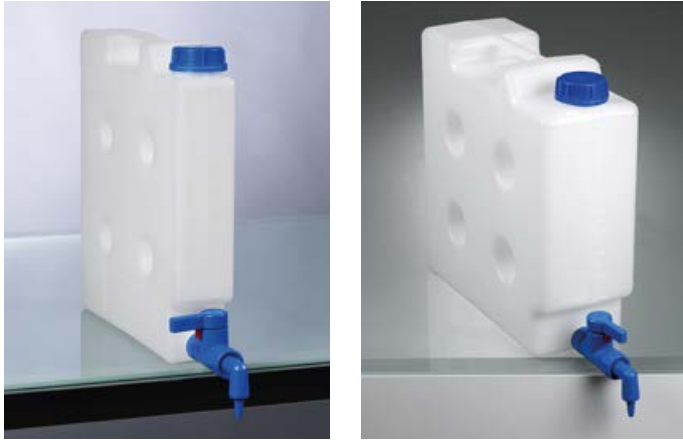

The Compact jerrycan & StopCock set consists of the compact jerrycan with glands 5 l (0435-2050) or 10 l (0435-2100) and the spigot StopCock (0525-1000).

Compact jerrycan & Compact stop cock set

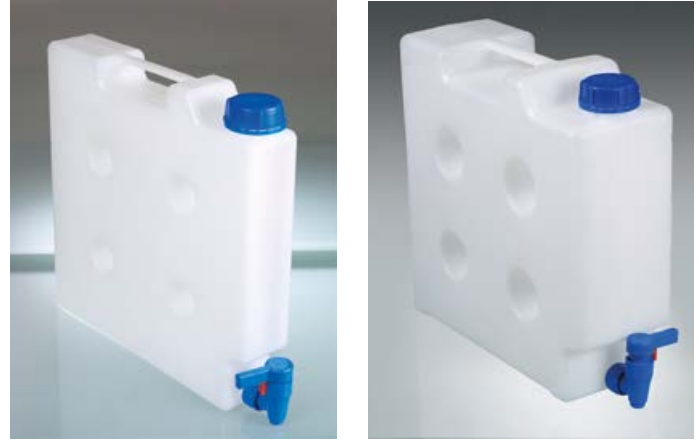

The Compact stop cock is the ideal addition to the compact jerrycan – for perfect storage and filling when space is at a premium! The space-saving set consists of the compact jerrycan with glands 5 l (0435-2050) or 10 l (0435-2100) and the spigot Compact (0530-1000).



Compact jerrycan & StopCock set

Capacity l	Item no.
5	0435-0001 N4
10	0435-0010 N4

Compact jerrycan & Compact stop cock set

Capacity l	Item no.
5	0435-3000 N4
10	0435-3010 N4

Compact jerrycan set, electroconductive



The electrically conductive compact jerrycan set consists of a compact jerrycan with a capacity of 5 litres (0435-2055) or 10 litres (0435-2105) and a StopCock PA (0525-1100). The stopcock and canister can be earthed with an anti-static set and can therefore be used in explosion-proof areas.



⚠ Caution! When working with combustible liquids, the canister must be earthed! Use anti-static set!

Compact jerrycan set, electroconductive		⚠ Ex
Capacity l	Item no.	
5	0435-0005 N4	
10	0435-0015 N4	
📦 Accessories		
Description	Item no.	
Anti-static set	5602-1000 N4	

StopCock PA, electroconductive



Commercially available spigots made of the materials polyethylene or polypropylene cannot be used for solvents. The spigot StopCock PA is made of electrically conductive polyamide and therefore perfectly suitable for solvents. StopCock PA fits onto 3/4" outer threads and with the supplied adapter onto 3/4" inner threads and therefore onto nearly all commercially available canisters and barrels where the discharge thread is at the bottom.

- ▶ With discharge angle and rotatable spout preventing drips
- ▶ With tapered spout for bottles with narrow openings with a diameter from 6 to 8 mm
- ▶ Media-contacting parts PA conductive to electricity and PTFE
- ▶ Supplied with PA adapter conductive to electricity for 3/4" inner thread



⚠ Caution! Note the "List of Chemical Resistance"!

StopCock PA, electroconductive			⚠ Ex
Thread, inflowing side	Thread, outflowing side	Item no.	
3/4" inner thread cap nut	spout/nozzle	0525-1100 N4	
📦 Accessories			
Description	Item no.		
Anti-static set	5602-1000 N4		

Ball valve PP



Ball valve PP fits all containers with G 3/4" connection thread. It can be attached to nearly all containers with thread adapters. Robust industrial quality, large flow.

- ▶ Suitable for crystallising media
- ▶ Max. 4 bar pressure at 20 °C
- ▶ With connecting cap nut, guaranteed vertical position of the valve
- ▶ Incl. discharge angle
- ▶ Hose nozzle 16 mm Ø
- ▶ Nominal width 11 mm Ø

Ball valve PP

Item no.

0500-0100



N4

Accessories

Description

Sealing tape PTFE, width 12 mm, length 12 m

Price €

2.01

Item no.

0006-4514 N3

Ball valves PP for barrels



Ball valves for barrels made of PP for barrels with thread connections.

- ▶ Suitable for solidifying media
- ▶ Max. 4 bar pressure at 20 °C
- ▶ Individually adaptable, through various accessories

Ball valves PP for barrels

Thread, inflowing side	Thread, outflowing side	Nominal width mm	Item no.
1/2" outer	1/2" inner	15	0500-0112 N4
3/4" outer	3/4" inner	20	0500-0134 N4
1" inner	1" inner	25	0500-8001 N3
1/2" inner	1/2" inner	15	0500-8002 N3
3/4" inner	3/4" inner	20	0500-8003 N3

Accessories

Description

Tube nozzles, fixed, straight 1/2" outer

Tube nozzles, fixed, straight 3/4" outer

Tube nozzles, fixed, straight 1" outer

Tube bend, fixed, 1/2" outer

Tube bend, fixed, 3/4" outer

Tube bend, fixed, 1" outer

Adapter for ball valve, Coarse thread Tri-Sure 2" outer, 3/4" inner

Adapter for ball valve, Fine thread 2" outer, 3/4" inner

Sealing tape PTFE, width 12 mm, length 12 m

Item no.

8545-0012 N3

8545-0034 N3

8545-0100 N3

8547-0012 N3

8547-0034 N3

8547-0100 N3

0600-0140 N3

0600-0180 N3

0006-4514 N3

Ball valve PP, food

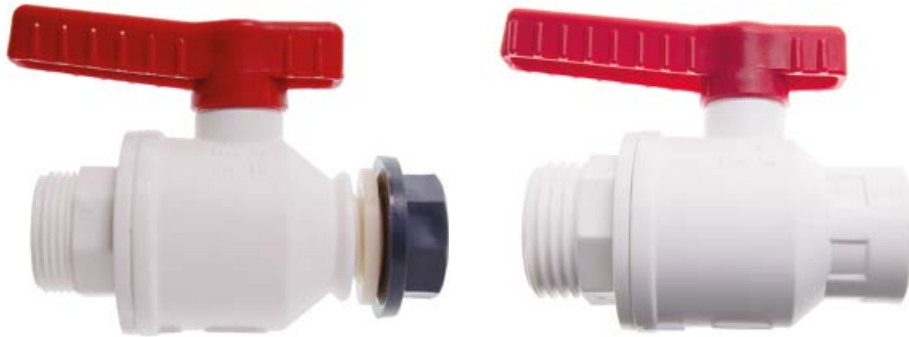

Ball valve made of PP with outer / inner thread, fibre-glass reinforced, ball made of PP, handle with O-ring made of food-safe NBR and seal made of HDPE.

- ▶ Max. operating pressure 10 bar (at +20 °C)
- ▶ Max. operating temperature 100 °C
- ▶ Suitable for food

Hose angle bracket, 90°, with cap nut, inner thread and reducing nozzle.



Spigot "Air"



No additional ventilation opening required, PE, transparent, 3/4" thread connection outside.

- ▶ Self-venting
- ▶ NW 13 mm
- ▶ Seal made of natural rubber

Ball valve PP, food

Thread, inflowing side	Thread, outflowing side	Nominal width mm	Item no.
1/2" inner	M29x1,75 outer	15	0500-8102 N3
3/4" inner	M36x3 outer	20	0500-8103 N3
1" inner	M42x3 outer	25	0500-8101 N3
1/2" outer	M29x1,75 outer	15	0500-8202 N3
3/4" outer	M36x3 outer	20	0500-8203 N3
1" outer	M42x3 outer	25	0500-8201 N3

Accessories

Description	Item no.
Container connection, white 1/2" outer	8533-0012 N3
Container connection, white 3/4" outer	8533-0034 N3
Container connection, white 1" outer	8533-0100 N3
Tube bend with cap nut, thread M29x1,75	8548-0020 N3
Tube bend with cap nut, thread M36x3	8548-0025 N3
Tube bend with cap nut, white, thread M42x3	8548-0030 N3
Sealing tape PTFE, width 12 mm, length 12 m	0006-4514 N3

Spigot "Air"

Item no.	
0533-0010	N3

Stainless steel spigot



Very sturdy and robust spigot made of stainless steel AISI 304 (1.4301). The outlet of the spigot turns 360° so it can be adjusted to any required position. With a practical suspension device for filling container and eyelet for shutting off the spigot.

- ▶ Seals PTFE, FKM
- ▶ Self-closing
- ▶ Thread connection 3/4"
- ▶ Lockable
- ▶ NW 10 mm

Stainless steel spigot

Item no.
0535-0020



N4

Spigot "Brass"



Barrel tap for petrochemical liquids, closed independently when not used (increased safety), thread connection 3/4" on the outside.

- ▶ Seals NBR
- ▶ Self-closing
- ▶ NW 10 mm

Spigot "Brass"

Item no.
0535-0010



N4

Adapter set LaboPlast®



Adapter set consisting of:

- ▶ Thread adapter 3/4" - Hünersdorff
- ▶ Thread adapter 3/4" - Kautex
- ▶ Thread adapter 3/4" - cylindrical G 3/4" barrel thread
- ▶ Thread adapter 3/4" - conical R 3/4" barrel thread
- ▶ Hexagonal key for thread adapter



Thread adapters LaboPlast® 3/4"



① Thread adapter 3/4" - Hünersdorff

② Thread adapter 3/4" - Kautex

③ Thread adapter 3/4" - cylindrical G 3/4" barrel thread

④ Thread adapter 3/4" - conical R 3/4" barrel thread

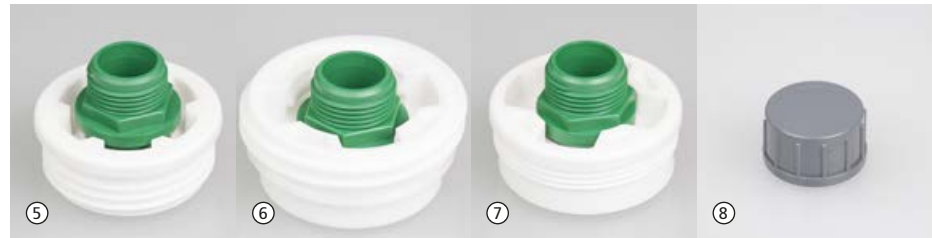

⑤ Thread adapter 3/4" - coarse thread, Tri-Sure 2"

⑥ Thread adapter 3/4" - coarse thread, Mauser 2"

⑦ Thread adapter 3/4" - fine thread 2"

⑧ Captive cap for 3/4"



StopCock spigots, ball valves and other accessories can be connected to most commercially available containers, with the LaboPlast® thread adapters. All adapters have a standard outer thread R 3/4".

⑨ Hexagonal key for thread adapter

Thread adapter set LaboPlast®

Item no. 0600-0050 N4

Thread, outflowing side	Thread, inflowing side	Colour	Material	Item no.
① Hünersdorff	3/4"	red	PP	0600-0010 N4
② Kautex	3/4"	blue	PP	0600-0020 N4
③ cylindrical G 3/4" thread connection	3/4"	black	PP	0600-0150 N4
④ conical R 3/4" thread connection	3/4"	green	PP	0600-0030 N4
⑤ coarse thread, Tri-Sure 2"	3/4"	green/white	PP/PE	0600-0094 N4
⑥ coarse thread, Mauser 2"	3/4"	green/white	PP/PE	0600-0120 N4
⑦ fine thread 2"	3/4"	green/white	PP/PE	0600-0190 N4
⑧ captive cap for 3/4"		grey	PVC	0600-0090 N4
⑨ hexagonal key for thread adapter		blue	PP	0600-0001 N4

Spigot Jumbo, with tap



Spigot with tap for R 2" barrel thread, 50 mm flow, for viscous media such as lacquers, glue, shampoo.

- ▶ Cost-effective tap
- ▶ PE, brown
- ▶ Seal made of EPT

Spigot Jumbo, with tap

Item no.
0534-0020



N4

Barrel valve



The barrel valve enables quick and clean emptying even with highly viscous liquids.

It is suitable for metal barrel with 2" BSP TriSure metal barrel screw joint.

The barrel valve enables opening the barrel closure as well as emptying and reclosing it even with lying, full barrels without having to move them.

- ▶ Glas fibre reinforced PP
- ▶ Seals NBR

Barrel valve

Item no.
0536-0010



N4

IBC discharge valves

The IBC discharge valve is a sturdy, high-quality ball valve with a hose connection and connection adapter including seal, for standard thread S 60x6 external or 1" external, designed to fit all commonly used European IBC containers.

With the appropriate thread, the discharge valve can also be screwed directly onto the original discharge valve that is already on the IBC tank if the original valve is leaking or faulty. In this way the IBC discharge valve ensures fast and reliable residual emptying of the container with good dosing.

The discharge valve is an indispensable accessory to ensure a professional connection of the hose or for filling from your IBC container.

- ▶ 1" flow
- ▶ Suitable for connection threads S 60x6 external or 1" external
- ▶ Discharge valve and sealing cap PP fibreglass-reinforced, ball and adapter PP
- ▶ Max. operating pressure 10 bar (at +20 °C)
- ▶ Max. operating temperature 80 °C

① IBC discharge valve with 90° hose nozzle and sealing cap. The hose can also be closed with the enclosed sealing cap. Hose nozzle external PA Ø 30 mm, suitable for flexible hoses.

② IBC discharge valve with innovative hose screw connection. The hose screw connection allows you to attach a wide range of hoses quickly, easily and reliably. No additional hose clamp is needed. Hose fitting PP/POM, external Ø 25 mm.



① IBC discharge valve with angle discharge		
Item no. 0534-0002		N3
② IBC discharge valve with hose screw connection		
Item no. 0534-0001		N3

Drain safety stand



Residual liquid from pump tubes or samplers can be reliably collected with the drain safety stand. The safety stand is resistant to diluted bases and acids. The collecting container can be filled with a neutralisation medium which dilutes and neutralises residual liquid.

The stand pipe is mounted on the wall with sturdy pipe clamps. The pipe clamps can simply be opened to remove the safety stand.

The container for collecting liquid can be unscrewed, making it convenient to replace or empty.

Drain safety stand

Total length cm	Inner dia. mm	Item no.
117	35	5618-1000 N4

General pump accessories



Threads can be ideally sealed with the sealing tape for threads made of PTFE. Low abrasion, excellent chemical resistance, temperature resistant from -80 °C to +260 °C.

Sealing tape PTFE

Width mm	Length m	Item no.
12	12	0006-4514 N3

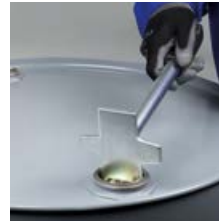

Universal barrel key for effortless opening even of tight barrel closures 3/4" to 2". An unbreakable tool made of zinc-plated steel.

Universal barrel spanner

Item no.	N4
5690-0090	



Hexagonal nut with inner thread.



Flat seals made of Polyethylene, transparent fitting outer or inner thread.

► PE

Hexagonal nuts

Thread	Material	Item no.
1/2"	HDPE	8537-0012 N3
3/4"	HDPE	8537-0034 N3
1"	HDPE	8537-0100 N3
2"	PP	8537-0200 N3

Flat seals, PE

Thread	Model	Pieces per pack	Item no.
1/2"	fits outer thread	10	8538-0012 N3
3/4"	fits outer thread	10	8538-0034 N3
1"	fits outer thread	10	8538-0100 N3
2"	fits outer thread	10	8538-0200 N3
1/2"	fits inner thread	10	8539-0012 N3
3/4"	fits inner thread	10	8539-0034 N3
1"	fits inner thread	10	8539-0100 N3

Rubiflex protective gloves



With short or long gauntlet. Safe working with fats, mineral oils, solvents and many acids and alkalis.

- ▶ Made from nitrile rubber
- ▶ Very flexible, soft to the touch
- ▶ High abrasion and cut resistance
- ▶ Comfortable cotton interlock interior
- ▶ To standard EN 374

Attention! Make sure to pay attention to the "List of Chemical Resistance"!

Rubiflex protective gloves				
Model	Length cm	Item no.		
① standard	37	2507-0002	N3	
② long wrist	60	2507-0003	N3	

Protective gloves nitrile



Made of nitrile, proven when handling acids, fats and solvents.

Attention! Make sure to pay attention to the "List of Chemical Resistance"!

Protective gloves nitrile		
Item no.		
2507-0004		N3

Plastic apron, PVC



Plastic apron made of PVC with eyelets, neck band and waist band welded into the apron, industry quality, black, fabric reinforced, size 80 cm x 100 cm.

Attention! Make sure to pay attention to the "List of Chemical Resistance"!

Plastic apron made of PVC		
Item no.		
2507-1001		N3

Drum holder | for setting down containers



The storage area of the drum holder can be adjusted for height and provides a place for setting down the filling container directly under the discharge of drum pumps. This prevents the danger of the liquid splashing while being poured from a high height – for example if the filling container is standing on the floor. The user also has both hands free while dispensing and is able to remove larger quantities conveniently. A scale with container can also be placed on the storage area so the liquid that is being dispensed can be measured accurately. The holder can be used for Bürkle pumps with discharge tube or discharge hose. Discharge hoses can easily be inserted into the foldaway fastening. Can be used for plastic or stainless steel drums.

- ▶ Stainless steel AISI 304
- ▶ For drums with 60 litres to 220 litres (rim height at least 10 mm)
- ▶ Storage area with adjustable height
- ▶ Size storage area: 240 x 240 mm
- ▶ Height of the filling container: max. 470 mm (when used with discharge hose)
- ▶ Load capacity: 10 kg

Drum holder

Item no.
5618-0200



N4

SafetyBox



Panorama safety goggles and protective gloves made of nitrile for personal safety, stored cleanly in a box. Recommended by trade associations.

 Attention! Make sure to pay attention to the "List of Chemical Resistance"!

SafetyBox

Item no.
2507-9000

N3

Eyes Fresh mini eyewash station



Mini eyewash station ideal for the lab, filling stations or all work places where aggressive substances are used. Eyes Fresh can be attached to any standard cold water tap. For normal use of the tap, just press the button and the function changes back from the eye wash (returns automatically to eyewash-function when the tap is closed). Can be fitted onto taps with M22x1, 1/2" or 3/8" outer thread. With sufficient water pressure provided, performance according to DIN EN 15154-2.

Eyes Fresh mini eyewash station

Model
Press button for normal use



Item no.
2515-0100 N4

Eye rinsing bottle



Empty bottle for 600 ml contents, leakproof due to valve and dust protection cap. Instructions printed on, made of transparent PE.

Eye rinsing bottle



Item no.
2507-2000

N3

Wall fixture

Item no.
2507-2001

N3

Eye protection / safety goggles



Ultra light build of only 18 grammes total weight. Maximum flexibility, perfect and slip-free fit.

Safety goggles Ultralight

Colour	Item no.
blue	2502-1002 N3



Ultra-light protective goggles with sporty design, maximum wearing comfort, according to DIN/EN standard.

Casual style safety goggles

Colour	Item no.
blue/orange	2502-2010 N3



Over-goggles with hingeless side pieces and with soft side piece ends. Combines the advantages of goggles with side pieces with the wearing properties of headbands. The flexible side piece design allows it to adapt to different wearing situations, with or without glasses. DIN EN 166 - 168 and 170.

Safety goggles Ultraflex

Colour	Item no.
blue	2502-1003 N3



With anatomically designed wrap-around screen for an increased degree of safety. Unrestricted view in all directions, larger cover by 20 % compared with normal glasses with side pieces, UV protection up to 400 nm.

Safety goggles Style

Colour	Item no.
black	2502-1006 N3



Lightweight, unrestricted lateral sight, wraparound side arms and variable side pieces guarantee the perfect fit without pressure points, lateral safety shields integrated in the goggle's lens, according to DIN EN 166 and 170.

Astrospec safety goggles

Colour	Item no.
blue	2502-4000 N3

Eye protection / safety goggles



Anti-fog lens, suitable for wearers of glasses, with ventilation system, unrestricted lateral view, close fitting, pressure-free fit, according to DIN/EN standard.

Ultravision safety goggles

Colour	Item no.
orange	2502-1007 N3



Very comfortable over-goggles with unrestricted side view, suitable to go over most glasses. 180° field of vision, lateral ventilation through the side shields. Without coating. With Polycarbonate side pieces. According to DIN EN 166 -168 and 170.

Panorama safety goggles

Colour	Item no.
glass clear	2502-1001 N3

► Ideal as goggles for visitors



Extremely robust eye-wear case with reinforced zipper and belt loop. Suitable for all spectacles, not for safety goggles Ultravision.

Case with belt loop for all glasses with temple

Colour	Item no.
black	2502-1008 N3



Very robust large eye-wear case for panoramic goggles with zipper, belt loop and additional compartment. Suitable for all spectacles and panoramic goggles.

Case with belt loop for all glasses and goggles

Colour	Item no.
black	2502-1009 N3

Table of contents samplers

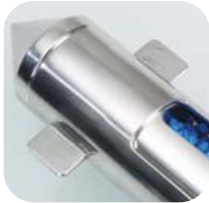

- 60 – 77 Samplers for bulk goods
- 60 – 65 Zone samplers
- 68 – 69 Samplers for silos
- 70 – 74 Samplers for pharmaceutical products
- 74 – 77 Bag/sack samplers
- 78 – 85 Accessories for bulk samplers
- 86 – 90 Samplers for viscous substances
- 91 – 112 Samplers for liquids
- 101 – 107 Vacuum samplers
- 108 – 112 Dipping bottles
- 113 – 155 Disposable & sterile samplers
- 124 – 159 Scoops, ladles and spoons
- 127 – 159 Spatulas, scrapers and tweezers
- 132 – 149 Disposable and sterile funnels
- 160 – 161 Ice and meat sampling
- 162 – 163 Soil sampling
- 164 – 167 Accessories for samplers



Samplers

Sampling from liquids, bulk goods and viscous media

Take samples – but do it right!

Taking samples

When taking samples, a random test is taken from an overall quantity. These samples serve as the basis for the analysis regarding quality assurance. The correct procedure for taking spot samples is therefore a very important subject. Only with representative and authentic samples can reliable information about the quality, properties or composition of a particular material be provided.

Very precise material analyses can be carried out with the most up-to-date technology. However, the technology is no good if an error occurs when the sample is taken and this error continues through all phases of the analysis, with the consequence that the final result of the quality check is wrong.

Correct information about the properties of a material can only be provided if the sample is taken properly and treated in the same way as in the subsequent analysis. The basic point is that the properties and composition of the sample quantity correspond exactly with the material quantity that has to be evaluated.



Taking samples - but how?

When taking samples, some essential stipulations such as DIN-standards have to be complied with. The recommendation is to follow a company-internal checklist which should be a fixed component of a company's quality standards. All relevant steps for taking samples are documented in this checklist so that they can be traced at any time.

Location for taking samples

The location from where the samples are taken has to be as clean as possible. At the very least, the use of clean samplers, equipment and tools has to be considered. During the procedure, no external factors must influence the sampling. Even small external contamination can significantly alter the examination result. Detergents which are used to clean the samplers or the sample packaging can also falsify the result of the analysis.



Taking samples - but who? - Qualified personnel

Only skilled personnel should take the samples. It must be guaranteed that sampling is carried out exactly in accordance with the stipulated DIN-standards or internal guidelines.

Technical knowledge is of utmost importance because altered circumstances can only be reacted to on-site. Only trained personnel can quickly and safely recognise mistakes that occur or altered circumstances and react accordingly.

Taking samples - with what? - Sampling equipment

Choosing the right sampling equipment depends on many different selection criteria. It depends on the material properties of the sampler as well as on the type of sampling, the container or the site where the material is located, and the frequency with which the



sampling has to be carried out. In addition to individual requirements for sampling, all equipment should fulfil the basic principles explained below:

Sampler material

The equipment should be made of inert substances from which no material can come loose and which does not react with other substances and therefore cannot

contaminate the sample. The inert substance depends on the medium to be sampled. As a general rule, samplers made of stainless steel and high-quality plastic such as PTFE are very suitable.

Cleaning the sampling equipment

It should be easy and quick to clean the equipment and – under certain conditions – to sterilise it. In the food industry, sterile-packed disposable samplers are recommended which can be disposed of after use.

Processing the samplers

Samplers must not have any grooves or crevices because residual material collects in such crevices and cannot be easily removed. This means that cross-contamination and memory effects can no longer be ruled out.

Surface of the equipment

The samplers' surfaces have to be especially smooth, for example, electro-polished stainless steel or PTFE. This prevents material from being deposited and simplifies cleaning. When selecting the appropriate sampling equipment, you must ensure that it is finished properly on the inside. Equipment with only a smooth external surface will not meet any quality standards.

Sampling techniques – physical and analytical sampling

A distinction is made between physical and analytical/chemical sampling.

During **physical sampling**, the bulk density, material distribution, material properties and – if required – colouring or contamination are determined. It is especially important in this case that the sampler does not change or destroy the material's properties while taking the sample. A sample taken onsite still has to be transported. During packing and transport, the same high quality standards should apply as during sampling, so that the sample reaches the laboratory unaltered.

During **analytical sampling**, special attention must be paid to cleanliness in addition to the aspects listed above. However, the material properties can be disregarded at times because the sample will be specially processed. In this case, equipment can be used which changes the physical properties of the material.

Any questions?

We will be happy to advise you.

Talk to us - telephone +49 7635 82795-0.

Or send an email to info@buerkle.de.

Bürkle GmbH - your partner for all questions about manual sampling.



More information about
„Take samples – but do it right!“:
www.buerkle.de/en/knowhow/take-samples-but-do-it-right

Zone samplers | for all kinds of bulk goods



1. Multi sampler (closed chambers)
2. All layer sampler (open inner tube)
3. Uno sampler (one closed chamber)

Bürkle zone samplers are used for taking samples of bulk goods of any kind.

The big advantage of zone samplers is that all-layer samples can be collected from all layers of the container.

Various bulk goods can be collected with the lances, from the finest powder to large grains such as corn or nuts.

The zone samplers are available in different lengths. 55 cm (only Multi, Uno and All-layer sampler) especially suitable for sacks, 85 cm long (especially for barrels, tubs, mixed containers) and 150 cm as well as 250 cm (only Jumbo sampler) for big bags, silos, tanks.

Safe and reliable sampling is made even easier with useful special accessories such as sealing sleeves, Quali-Paper, cleaning brushes, emptying devices and close-it control seals.

The zone samplers are available in different models for different sampling tasks.

- ▶ Smallest possible gap between the inner and the outer tube
- ▶ Easy cleaning, removable tip
- ▶ Colour coding (Multi and Uno sampler)
- ▶ Ultra-pure materials
- ▶ Excellent processing, robust model



Colour coding: Identification to prevent mixing up multi samplers and single samplers.



Zone samplers | for all kinds of bulk goods



All-layer sampler, with open inner tube, no separate chambers, and large sampling volume. For all-layer samples through all the layers of the sample.

- ▶ Aluminium or AISI 316L (1.4404)
- ▶ 25 mm Ø



Corresponds to ISTA standard for seed lengths of 10 mm (wheat, oats) and 5 mm (flax, vetches).



Multi sampler with several closed chambers, for multi point sampling from several predetermined sampling depths.

- ▶ Aluminium, AISI 316L (1.4404) or AISI 316L/PTFE
- ▶ Version made of AISI 316L (1.4404)/PTFE with low weight due to PTFE sample chambers
- ▶ With colour coding system
- ▶ 25 mm Ø



Uno sampler made of stainless steel AISI 316L (1.4404)/PTFE with a closed sample chamber for point sampling from a predetermined sampling depth.

- ▶ Outer tube stainless steel AISI 316L (1.4404), sample chambers made of PTFE
- ▶ With colour coding system
- ▶ 25 mm Ø



close-it seals see p. 78

All-layer-sampler

Material	Total length cm	Insertion depth mm	No. of openings	Chamber volume ml	Item no.
aluminium	55	430	3	70	5317-2055 N4
aluminium	85	710	3	130	5317-2085 N4
aluminium	150	1355	5	260	5317-2150 N4
AISI 316L	55	430	3	70	5316-2055 N4
AISI 316L	85	710	3	130	5316-2085 N4
AISI 316L	150	1355	5	260	5316-2150 N4

Multi sampler

Material	Total length cm	Insertion depth mm	Number of collection chambers	Chamber volume ml	Item no.
aluminium	55	430	3	14	5317-1058 N4
aluminium	85	710	3	17	5317-1085 N4
aluminium	150	1355	5	17	5317-1150 N4
AISI 316L	55	430	3	14	5316-3055 N4
AISI 316L	85	710	3	17	5316-3085 N4
AISI 316L	150	1355	5	17	5316-3150 N4
AISI 316L/PTFE	55	430	3	14	5316-0055 N4
AISI 316L/PTFE	85	710	3	17	5316-0085 N4
AISI 316L/PTFE	150	1355	5	17	5316-0150 N4

Uno sampler

Material	Total length cm	Insertion depth mm	Number of collection chambers	Chamber volume ml	Item no.
AISI 316L/PTFE	55	430	1	17	5316-1055 N4
AISI 316L/PTFE	85	710	1	17	5316-1085 N4
AISI 316L/PTFE	150	1355	1	17	5316-1150 N4

Use

1. Turn the handle, close the chambers.
2. Insert the sampler to the required depth.
3. Open the chambers, sample flows into the chamber.
4. Close the chambers.
5. Pull out the sampler.
6. Close the insertion opening with the close-it control seal.
7. Empty the chambers onto Quali-Paper or with the emptying device.

Zone samplers | for all kinds of bulk goods



Jumbo sampler with a tube diameter of 50 mm, ideal for coarse grains and larger quantities. With an open inner tube and large sampling volume, for all-layer samples through all layers of the sample or with sample chambers separated by PTFE separators for multi point sampling from several predetermined sampling depths.

- ▶ Aluminium or aluminium/PTFE
- ▶ 50 mm Ø

Jumbo sampler

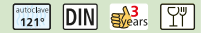

Model	Total length cm	Material	Insertion depth mm	No. of openings	Chamber volume ml	Item no.
All layer - open inner tube	95	aluminium	850	3	880	5319-1085 N4
All layer - open inner tube	165	aluminium	1500	5	1700	5319-1150 N4
All layer - open inner tube	265	aluminium	2500	7	2900	5319-1250 N4
Multi - closed chambers	95	aluminium/PTFE	850	3	390	5319-2085 N4
Multi - closed chambers	165	aluminium/PTFE	1500	5	650	5319-2150 N4
Multi - closed chambers	265	aluminium/PTFE	2500	7	910	5319-2250 N4

Accessories for zone samplers



Emptying device



Sealing sleeves zone sampler 25 mm usage



Quali-Paper for zone sampler



Cleaning brushes

Emptying device



Model	Material	Length cm	Item no.
device with 3 funnels	AISI 304	100	5317-0030 N4
emptying funnel separate	AISI 304		5317-0033 N4

Sealing sleeves



Dia. mm	Material	Pieces per pack	Item no.
25	PP	3	5317-0011 N4
50	PVC	1	5317-0010 N4

Quali-Paper

L x W cm	Pieces per pack	Item no.
89 x 23	50	5317-0001 N4

Cleaning brushes

Dia. mm	Length cm	Material	Item no.
25	40	PVC/stainless steel	5304-0040 N4
25	60	PVC/stainless steel	5304-0060 N4
25	80	PVC/stainless steel	5304-0080 N4
25	100	PVC/stainless steel	5304-0100 N4
50	100	PVC/stainless steel	5304-5100 N4
50	300	PVC/stainless steel	5304-5300 N4

Zone sampler Spiralus

- ▶ Representative sample of the container layers.
- ▶ Aluminium, anodised
- ▶ Tip PA
- ▶ 38 mm Ø
- ▶ Low weight

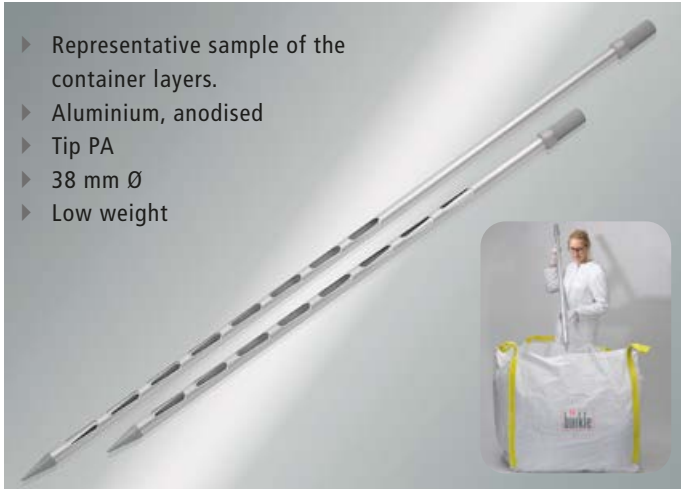

Zone sampler Spiralus guarantees precise zone sampling through all layers of the sample. The spiral arrangement of the sampling slits means that these are opened one after the other from bottom to top. In this way the lowest opening is filled first and then those above it in sequence until the complete Spiralus has been filled. The shape of the sampling slits prevents seeds from being cut up. The zone sampler Spiralus provides an excellent all-layer sample.

Applications

Spiralus is particularly suitable for sampling coarse-grained bulk goods, seeds and pellets at locations such as soil heaps, warehouses, trucks, railway goods wagons, etc.

Zone sampler Spiralus

Total length cm	No. of openings	Weight g	Chamber volume ml	Item no.
145	8	1400	770	5318-0145 N4
200	8	2000	1100	5318-0200 N4

Accessories

Description	Item no.
Cleaning brushes 50 mm dia., length 1000 mm	5304-5100 N4
Quali-Paper	5317-0001 N4

EasySampler | easy to empty



It is possible to take multiple samples from bulk goods with this sampler quickly and easily.

Emptying has been greatly simplified and in this model takes place via the tip. The advantage: The sample can be emptied directly into the sample container without having to disassemble the EasySampler, in order to obtain a mixed sample for instance. The bulk material must be free-flowing or self-flowing.

- ▶ Stainless steel AISI 316L (1.4404)
- ▶ For sample opening from Ø 52 mm



EasySampler has been developed in cooperation with an international chemical concern based in Ludwigshafen, Germany.

EasySampler

Chamber volume ml	Total length cm	Tube Ø mm	Item no.
60	100	32	5360-0600 N4
200	104,5	32	5360-1000 N4

All-layer drill



The all-layer drill is a special zone collector specifically designed for heavily compacted substances. Often it is very difficult or impossible with conventional zone collectors to penetrate media of this type and take a sample extending through all layers. By contrast, the drilling blades of the all-layer drill burrow easily and quickly to the required depth without expending any great force. This makes it easy to take samples of media, even those with high density, and every type of highly compacted powders and granulates. The all-layer drill thus allows you to take a representative sample through all the layers, even with greatly compressed media. It is ideal for larger containers, mixed containers, big bags, etc. in the building materials, chemical, pharmaceutical, food and luxury items industries.

- ▶ Stainless steel AISI 316L (1.4404)
- ▶ 25-mm diameter



All-layer drill

Material	Total length cm	Insertion depth mm	No. of openings	Chamber volume ml	Item no.
AISI 316L	150	1355	5	260	5310-0150 N4

Accessories

Description	Item no.
Cleaning brushes 25 mm dia., length 100 cm	5304-0100 N4

Core Sampler



Product is patented.

The core sampler can be used to take samples of bulk materials which can easily become stuck or settle during sampling due to their particle form. In comparison to standard all-layer samplers for bulk materials, the two-part core sampler has no gap dimensions in which the medium can become stuck while it is being removed. This makes it possible to take a proper sample of powders and granulates through multiple layers, for example glass balls or metal powders. Depending on the size, the stainless steel sampler can be used for a wide range of different containers, for example big bags or small containers. The bulk material sampler takes a representative core sample and is ideal for use in various laboratory and industrial applications.

- ▶ Stainless steel AISI 316 (1.4404)
- ▶ For bulk materials that become stuck or settle easily
- ▶ Scope of delivery: Core sampler (consisting of boring rod and boring tube), fixing clip

Core Sampler

Length mm	Dia. mm	Volume ml	Item no.
200	15	15	5310-0001 N4
400	25	110	5310-0002 N4
800	25	230	5310-0003 N4

All-layer-scratcher



The scratcher is a special sampler for powders and granules that do not flow freely.

The sample is transferred to the closable inner tube using a scraper. Sliding PTFE separators are used to divide the inner tube into different zones. The separators also prevent the sample from being mixed.

- ▶ For caked bulked goods
- ▶ Zones can be varied due to moveable PTFE separators
- ▶ Made of stainless steel AISI 316L (1.4404) and PTFE

All-layer-scratcher			
Dia. mm	Length mm	Chamber volume ml	Item no.
25	1000	180	5351-1000 N2
Accessories			
Description	Item no.		
Cleaning brushes 25 mm dia., length 100 cm	5304-0100 N4		

Scratcher | for non-pourable substances



The scratcher has particularly been designed for sampling cohesive, caked and not free-flowing substances.

- ▶ Stainless steel AISI 316L (1.4404)
- ▶ Total length 1000 mm
- ▶ Ø 25 mm

Use

1. Insert the closed lance into the sample.
2. Open the inner tube by turning the sample chamber when at the required depth.
3. Turn the scratcher by 360° in the sample, the scraper directs the caked material into the sample chamber.
4. Close the sample chamber.

Scratcher							
Chamber volume ml	Flute length mm	Outer dia. with scraper mm	Item no.				
5	22	32	5347-0005 N2				
10	45	32	5347-0010 N2				
25	110	32	5347-0025 N2				

PowderProof® | mobile powder sampling

Quality assurance starts with the inspection of incoming goods! An all-layer sample of bulk goods is no longer a problem with PowderProof®, the sampler for powders and granules.

PowderProof® is the practically proven professional solution for mobile sampling of powders and granules. Different lances and augers can be attached to the robust drive unit and swapped without any problems. This modular design makes PowderProof® a versatile instrument for sampling powders and granules from drums, barrels, bags or sacks.

Safe and reliable sampling is made even easier with useful accessories such as basket-enclosed bottles, sample bags and close-it control seals. PowderProof® with lance for horizontal use, such as sampling from sacks, with lance for vertical use, for sampling from open containers such as barrels, drums or bags.



PowderProof® | mobile powder sampling



- ▶ Many uses
- ▶ Stainless steel AISI 316L (1.4404)/AISI 301 (1.4310)
- ▶ Incl. motor, two rechargeable batteries, fast charger, lance, spiral screw, bags, clip for holding the bag and cleaning brush
- ▶ Additional spiral screws available as accessory



Use

1. The lance is inserted into the sack/container with the spiral screw rotating.
2. The powder or granules are immediately transported through the lance and filled directly into a sample bag or bottle at the lance outlet.

PowderProof®						
Model	Lance	Insertion depth mm	Item no.			
for powders up to 2 mm dia.	horizontal	300	5302-0302 N2			
for powders up to 2 mm dia.	vertical	600	5302-0602 N2			
for powders up to 2 mm dia.	vertical	900	5302-0902 N2			
for powders up to 2 mm dia.	vertical	1200	5302-1202 N2			
for granules from 2 up to 4 mm dia.	horizontal	300	5302-0301 N2			
for granules from 2 up to 4 mm dia.	vertical	600	5302-0601 N2			
for granules from 2 up to 4 mm dia.	vertical	900	5302-0901 N2			
for granules from 2 up to 4 mm dia.	vertical	1200	5302-1201 N2			

Accessories

Description	Item no.
Spiral screw for PowderProof® for powders up to 2 mm dia., for 300 mm	5302-0316 N2
Spiral screw for PowderProof® for powders up to 2 mm dia., for 600 mm	5302-0616 N2
Spiral screw for PowderProof® for powders up to 2 mm dia., for 900 mm	5302-0916 N2
Spiral screw for PowderProof® for powders up to 2 mm dia., for 1200 mm	5302-1216 N2
Spiral screw for PowderProof® for granules 2 - 4 mm dia., for 300 mm	5302-0317 N2
Spiral screw for PowderProof® for granules 2 - 4 mm dia., for 600 mm	5302-0617 N2
Spiral screw for PowderProof® for granules 2 - 4 mm dia., for 900 mm	5302-0917 N2
Spiral screw for PowderProof® for granules 2 - 4 mm dia., for 1200 mm	5302-1217 N2
Transport case LxWxH 123x25x11 cm	3600-2120 N4
Sampling bottle LDPE 500 ml	0318-0500 N3
Sampling bottle LDPE 1000 ml	0318-1000 N3
Basket for sample bottles 500 ml, Ø 84 mm, incl. holding ring	5302-2055 N2
Basket for sample bottles 1000 ml, Ø 100 mm, incl. holding ring	5302-2105 N2
Clamp for sampling bags, Ø 25	5338-0001 N2
Packaging bags with closure, 220x160 mm, 1000 ml, 100 pieces	2348-0006 N3

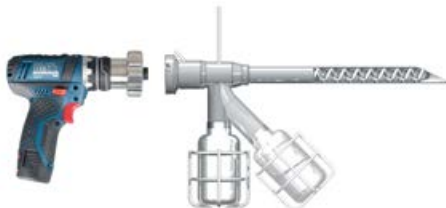

PowderProof® for horizontal and vertical use

Samplers for silos

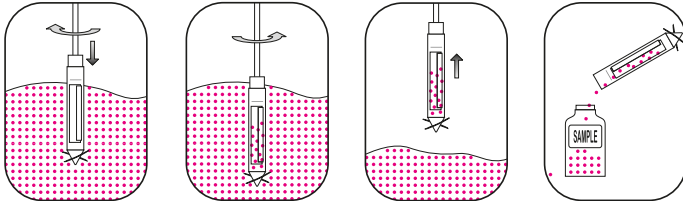

If bulk goods are transported over long distances (in trucks, railway goods wagons), separation may occur.

Taking the sample just from the surface therefore leads to the wrong result. Representative samples from all layers of the silo can be taken with the SiloDrill. The SiloDrill fits through all standard openings with its diameter of 90 mm.



- ▶ Of stainless steel AISI 304 (1.4301) or aluminium
- ▶ Standard length 150 cm, extendable in increments of 100 cm, max. 350 cm
- ▶ Sprung inner tube prevents jamming of coarse grains
- ▶ Scraper edge for cohesive substances
- ▶ Sturdy, removable T-handle
- ▶ Drill tip with drilling blades for easy boring
- ▶ Easy removal of the sample chamber, simple cleaning

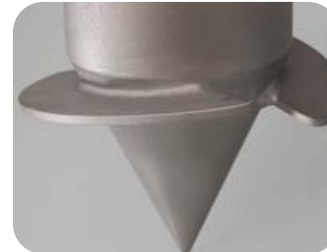

SiloDrill

Material	Total length cm	Spiral screw dia. mm	Chamber dia. mm	Volume ml	Item no.
aluminium	150	90	40	400	5301-1000 N4
AISI 304	150	90	40	400	5301-2000 N4

Accessories

Description	Item no.
SiloDrill extension AISI 304, 100 cm	5301-0500 N4
Transport case LxWxH 123x25x11 cm	3600-2120 N4

Silo sampler SiloPicker



The SiloPicker is ideal for taking bulk goods samples from silos. Using the extension rods, samples can be taken from depths down to 350 cm. The insertion depth depends on the density of the bulk goods.

► Stainless steel AISI 316L (1.4404)

Use

1. Insert SiloPicker into the bulk goods. When this is done, the closure sleeve automatically closes the collection container.
2. When the sampling depth has been reached, the closure sleeve is opened by gently pulling back the SiloPicker, the sampling container is filled.
3. Pull out the SiloPicker and empty it.



Silo sampler SiloPicker					
Chamber volume ml	Length cm	Outer dia. mm	Item no.		
100	130	50	5340-1100 N4		
Accessories					
Description	Item no.				
SiloPicker extension 50 cm	5380-0508 N4				
SiloPicker extension 100 cm	5380-1008 N4				
Transport case LxWxH 123x25x11 cm	3600-2120 N4				

Novartos | pharma zone sampler for sampling according to FDA guidelines for unit-dose sampling

Unit-Dose-Sampling

During powder separation checks and purity validations of powders, liquids and semi-solid substances, special procedures (unit-dose-sampling) must be employed to achieve the desired results.

Special sampling methods, which are required especially in the pharmaceutical industry in conformance with FDA and GMP specifications, require samplers with special features.

- ▶ High degree of preciseness
- ▶ Groove-free surfaces, electropolished if possible
- ▶ AISI 316 stainless steel or PTFE materials
- ▶ Sterilisable
- ▶ Easy and perfect cleaning

Many Bürkle Samplers fulfill these demands, have been tested in actual practice, and are distinguished by especially sturdy and precise machining.

Novartos is a pharma zone sampler for unit-dose sampling:

- ▶ For various sampling depths with simultaneous double sample or triple sample (Duo-Sampler or Triple-Sampler).
- ▶ Precise volume calibration with 40 exchangeable sample inserts with volumes from 0.1 ml to 4.0 ml, in increments of 0.1 ml.



Novartos is the pharmaceutical zone sampler for sampling in accordance with the FDA guidelines for unit dose sampling. With the Novartos pharmaceutical samplers, multiple individual dose samples (unit dose samples) can be taken from one or more sampling points in a single sampling.

Thanks to the intelligent design of these pharmaceutical samplers, the lance does not have to be inserted into the sampling material several times. This largely prevents mixing. This is an important criterion, especially when sampling very small quantities in the pharmaceutical industry. Novartos samplers can be used to take a large number of samples quickly and easily, including from the same point, thus allowing for representative reserve samples.

Novartos offers a wide range of sample volumes for selection. Many different inserts with sample volumes from 0 to 2.0 ml (Novartos Multi) or 4.0 ml (Novartos Uno) can be selected and combined. Withdrawal of a sample can be prevented at certain points with dummy inserts (0.0 ml). The immersion depths of the sample lance can easily be read on a laser-engraved depth scale.

- ▶ Several single-dose samples from one or more sampling points all in one sampling
- ▶ Precision-fit, easily interchangeable sample inserts
- ▶ Stainless steel V4A (1.4404 / 1.4571)
- ▶ 25 mm Ø



Double sampling



Triple sampling



Novartos | pharma zone sampler for sampling according to FDA guidelines for unit-dose sampling

Novartos Multi double sampling

With Novartos Multi double sampling, a double multi-point sample can be taken from multiple predefined sample zones. Depending on the length, four, seven or nine sample chambers are each fitted with two sample inserts for the double sampling.



Novartos Multi triple sampling

With Novartos Multi triple sampling, a triple multi-point sample can be taken from multiple predefined sample zones. Depending on the length, four, seven or nine sample chambers are each fitted with three sample inserts for the triple sampling.



Novartos Uno double sampling

With Novartos Uno double sampling, a double target-point sample can be taken from a predefined sample zone. A sample chamber is fitted with two sample inserts for the double sampling.



Novartos Uno triple sampling

With Novartos Uno triple sampling, a triple target-point sample can be taken from a predefined sample zone. A sample chamber is fitted with three sample inserts for the triple sampling.



i Novartos was developed in cooperation with a multinational operating Pharmaceutical/chemical group in Basel/Switzerland.

! Please order inserts separately! (Alternative sample volumes on request.)

Novartos Multi double sampling

Model	Length mm	Collection chambers	Number of inserts	Item no.
without inserts	600	4	8	5358-0602 N4
without inserts	1000	7	14	5358-1000 N4
without inserts	1400	9	18	5358-1402 N4

Novartos Multi triple sampling

Model	Length mm	Collection chambers	Number of inserts	Item no.
without inserts	600	4	12	5358-0603 N4
without inserts	1000	7	21	5358-1003 N4
without inserts	1400	9	27	5358-1403 N4

Accessories

Description	Item no.
Inserts for Novartos Multi capacity 0 ml	5358-0000 N4
Inserts for Novartos Multi, capacity 0.5 ml	5358-0005 N4
Inserts for Novartos Multi, capacity 1 ml	5358-0010 N4
Inserts for Novartos Multi capacity 1.5 ml	5358-0015 N4
Inserts for Novartos Multi, capacity 2 ml	5358-0020 N4

Novartos Uno double sampling

Model	Length mm	Collection chambers	Number of inserts	Item no.
without inserts	600	1	2	5358-0600 N4
without inserts	1000	1	2	5358-1001 N4
without inserts	1400	1	2	5358-1400 N4

Novartos Uno triple sampling

Model	Length mm	Collection chambers	Number of inserts	Item no.
without inserts	600	1	3	5358-0630 N4
without inserts	1000	1	3	5358-1030 N4
without inserts	1400	1	3	5358-1430 N4

Accessories

Description	Item no.
Inserts for Novartos Uno, capacity 0 ml	5358-0100 N4
Inserts for Novartos Uno, capacity 0.5 ml	5358-0105 N4
Inserts for Novartos Uno, capacity 1 ml	5358-0110 N4
Inserts for Novartos Uno, capacity 2 ml	5358-0120 N4
Inserts for Novartos Uno, capacity 3 ml	5358-0130 N4
Inserts for Novartos Uno, capacity 4 ml	5358-0140 N4

Accessories

Description	Item no.
Transport case LxWxH 123x25x11 cm	3600-2120 N4
Novartos head (not rounded)	5358-1011 N4

MicroSampler | useful for taking small samples, sterilisable



The MicroSampler has especially been designed for the sampling of small quantities of powder. Volumes of 0.2 ml, 0.5 ml, 1.0 ml, 2.0 ml, 5.0 ml and 10 ml can be sampled easily, quickly and cleanly from different sampling depths from sacks or containers. The tips of the MicroSampler are interchangeable. This means that tips with different volumes can be used.

- ▶ Point sampling
- ▶ Various lengths and volumes are available
- ▶ Tip can be removed, easy cleaning
- ▶ Stainless steel AISI 316L (1.4404)
- ▶ Sterilisable
- ▶ Additional tips are available in different sizes

Please order head separately!

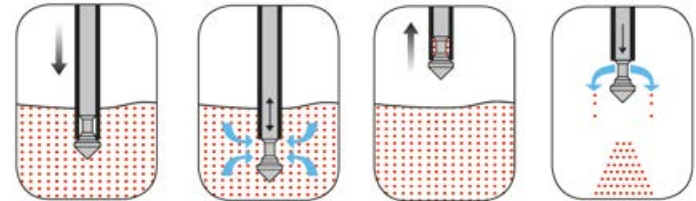

Use

1. Insert MicroSampler into powder.
2. At the predetermined point, open the volume tip by pressing the button, the sample flows in.
3. Close the volume tip, the sample is collected.
4. Pull back the lance, open the volume tip again, empty the sample.



MicroSampler

Tube Ø mm	Length cm	Model	Item no.
12	55	without head	5307-1055 N4
12	85	without head	5307-1085 N4
12	120	without head	5307-1120 N4
25	55	without head	5307-2055 N4
25	85	without head	5307-2085 N4
25	120	without head	5307-2120 N4

Accessories

Description	Item no.
MicroSampler heads fits tube with 12 mm dia., capacity 0.2 ml	5307-0102 N4
MicroSampler heads fits tube with 12 mm dia., capacity 0.5 ml	5307-0105 N4
MicroSampler heads fits tube with 12 mm dia., capacity 1 ml	5307-0110 N4
MicroSampler heads fits tube with 25 mm dia., capacity 2 ml	5307-0202 N4
MicroSampler heads fits tube with 25 mm dia., capacity 5 ml	5307-0205 N4
MicroSampler heads fits tube with 25 mm dia., capacity 10 ml	5307-0210 N4

PharmaPicker | for sampling very small quantities



For sampling very small quantities of highly potent, expensive or active powders for analysis. The smallest sample quantities from 0.1 ml to 2.5 ml can be collected with the PharmaPicker. By simply exchanging the volume tip in the collection cylinder for 0.1–1.2 ml or 1.25–2.5 ml, the sampling volume is modified.

The PharmaPicker has a length of 60 cm and can be extended repeatedly by 50 cm or 100 cm, maximum length 3.50 m. The PharmaPicker is available separately or as PharmaPicker Case in a handy transport box.

PharmaPicker Case consisting of: Collection cylinders in both sizes, extension rod 50 cm and 100 cm, handle, volume tips 0.4 ml, 0.6 ml, 0.8 ml, 1.0 ml, 1.2 ml, 1.4 ml, 1.8 ml, 2.0 ml, 2.3 ml and 2.5 ml (alternative sample volumes on request), transport box.

Use

1. Insert the required volume tip into the collection cylinder.
2. Insert the PharmaPicker, the disc sleeve closes the collection cylinder automatically.
3. The disc sleeve opens the collection cylinder at the required point, and the desired sample is collected.
4. Withdraw the PharmaPicker completely.
5. Empty the sample directly from the collection cylinder into the analysis container.

- ▶ Stainless steel AISI 316L (1.4404)
- ▶ Electro-polished

Please order head separately!

PharmaPicker					
Model	Item no.				
with collection cylinder for 0.10–1.20 ml, without head	5346-1000 N2				
with collection cylinder for 1.25–2.50 ml, without head	5346-2000 N2				
Case, completely	5346-0010 N2				

Accessories	
Description	Item no.
Volume heads for PharmaPicker, capacity 0.10 ml	5346-1010 N2
Volume heads for PharmaPicker, capacity 0.20 ml	5346-1020 N2
Volume heads for PharmaPicker, capacity 0.60 ml	5346-1060 N2
Volume heads for PharmaPicker, capacity 1.00 ml	5346-1100 N2
Volume heads for PharmaPicker, capacity 2.00 ml	5346-2200 N2
Volume heads for PharmaPicker, capacity 2.50 ml	5346-2250 N2

Accessories	
Description	Item no.
Extension rod PharmaPicker 500 mm	5380-0506 N4
Extension rod PharmaPicker 1000 mm	5380-1006 N4
Collection cylinder for 0.10–1.20 ml, without volume head	5346-1001 N2
Collection cylinder for 1.25–2.50 ml, without volume head	5346-2001 N2
Handle PharmaPicker	0006-8113 N3

PharmaSpoon | for ultrapure sampling



PharmaSpoon for taking samples of powdery substances, intermediate products and material in the pharmaceutical industry. Special materials with excellent surface qualities must be used for this to prevent cross-contamination. Our PharmaSpoon fulfils these requirements. Made of stainless steel AISI 316L (1.4404), surface highly polished by hand (not electro-polished!). The excellent surface properties of the PharmaSpoon provide significant advantages.

- ▶ Possible residues are even visible in the trace sector (μg sector)
- ▶ The surface is easy to clean
- ▶ The PharmaSpoon is also suitable for sterile sampling

The PharmaSpoon was developed by an internationally known pharmaceutical company in Basel, Switzerland, and its usefulness has been confirmed in actual practice.

PharmaSpoon

Total length mm

650



Item no.

5324-0001 N2

StickProof



Sampler for powder in the pharma area, made of stainless steel AISI 316L, material 1.4404. The especially slender tip can be inserted easily and deeply in order to take the sample. The conical inlet of the tip allows the collection of either very small or larger quantities. StickProof is constructed in one piece without edges, grooves or crevices for perfect and easy cleaning. The sample can be filled directly into the sampling bag from the outlet end. Fasten the bag with a sturdy clamp.

- ▶ Surface electro-polished
- ▶ Various sample quantities up to approx. 50 ml
- ▶ Incl. clamp and 100 PE sampling bags 120x170 mm

Corresponds to ISTA standard for seed lengths of 10 mm (wheat, oats) and 5 mm (flax, vetches).

StickProof



Length mm	Dia. mm	Item no.
410	25	5338-0410 N4
1100	25	5338-1100 N4

Accessories

Description	Item no.
Clamp for sampling bags, \varnothing 25	5338-0001 N2
Packaging bags with closure, 170x120 mm, 400 ml, 100 pieces	2348-0005 N3
Control seal close-it page 78	

Sampling lance Milky | acc. to EN ISO 707



- ▶ Stainless steel AISI 316L (1.4404)
- ▶ Insertion depth 385 mm
- ▶ Total length 480 mm
- ▶ Outer diameter approx. 28 mm

Universal powder and granules sampler made of stainless steel AISI 316L (1.4404).

Developed initially for milk powder samples, conforms to standards of DIN and IDF (International Dairy Federation).

The collector is inserted into bags or casks and the sample is removed using a semi-circular profile lance.



close-it seals and close-it food lock seals ensure non-leak closure of the insertion point in bags and BigBags. See p. 78.

Sampling lance Milky

Volume ml
150



Item no.
5321-0300 N4

Sampler Tubus



Sampler for pourable bulk goods up to approx. 1 cm in diameter. This makes it possible, for example, to remove hazel nuts, blends of tea, grain or similar items from large sacks.

- ▶ Also for coarse-grained bulk goods
- ▶ Made of stainless steel AISI 316L (1.4404)
- ▶ Special geometry of the tip

i Corresponds to ISTA standard for seed lengths of 10 mm (wheat, oats) and 5 mm (flax, vetches).

Use

1. Insert Tubus into a sack to the desired sampling depth, while keeping the collection tube closed using your hand.
2. When you remove your hand, the sample flows directly through the open tube into the container or sampling bag beneath it.

Sampler Tubus

Length cm	Dia. mm	Item no.
40	40	5382-0040 N4
80	40	5382-0080 N4

Accessories

Description	Item no.
Control seal close-it page 78	

QuickPicker | collects samples quickly and channels them directly into the sampling bottle



The core sampler QuickPicker is particularly suitable in the event that bulk goods are taken directly from sacks or bags and have to be filled into the original sampling bottle directly. QuickPicker is uncomplicated in its use and cleaning. No undercuts or edges mean no sample residues which could falsify subsequent samples. It is therefore ideal for quality control.

The sampler QuickPicker is delivered complete with two 250 ml PE sample bottles and with a cleaning brush.

QuickPicker | collects samples quickly and channels them directly into the sampling bottle

- ▶ Insertion depth 30 cm, diameter 25 mm
- ▶ Made of stainless steel AISI 316L (1.4404) or PP transparent for aggressive chemicals, scratchproof, sterilisable, cost-effective
- ▶ Removable tip, easy cleaning
- ▶ Additional sampling bottles made of PE or PP available as accessories



QuickPicker AISI 316L in use

i Corresponds to ISTA standard for seed lengths of 10 mm (wheat, oats) and 5 mm (flax, wetches).

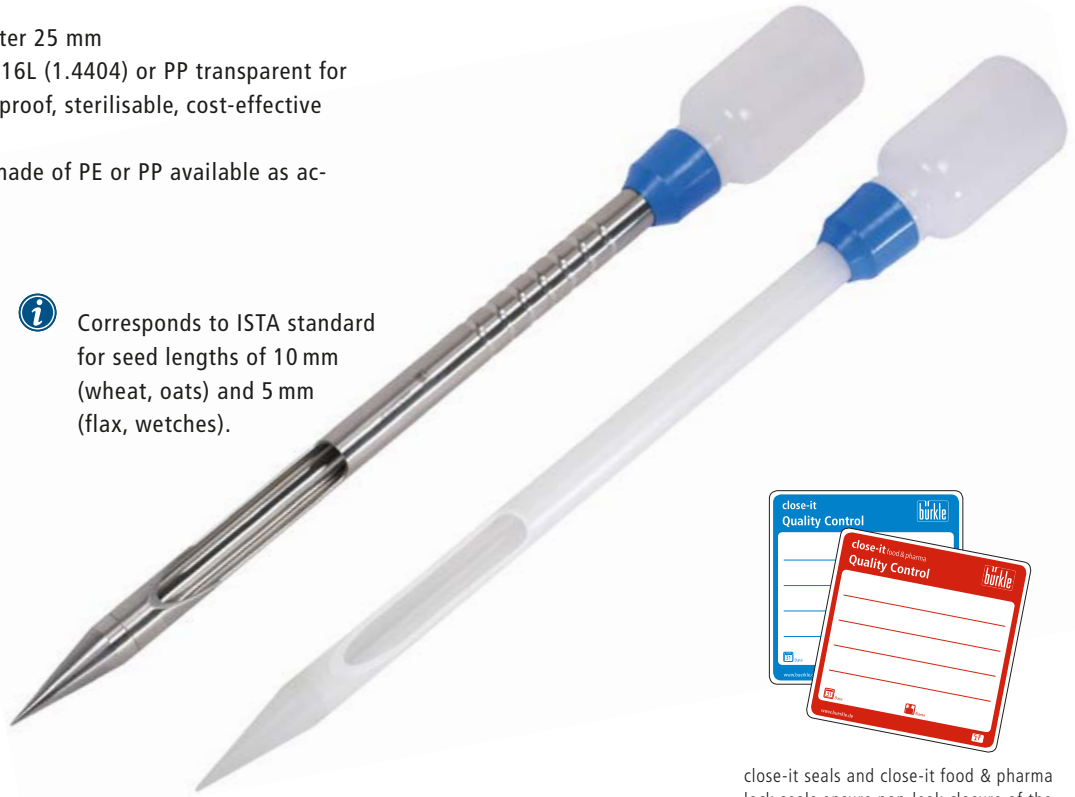

close-it seals and close-it food & pharma lock seals ensure non-leak closure of the insertion point in bags and BigBags. See page 78.

QuickPicker

Material	Insertion depth mm	Total length cm	Volume ml	Item no.
AISI 316L	300	50	75	5322-1300 N4
PP, transparent	300	50	75	5322-0300 N4



Accessories

Description	Item no.
Sampling bottle LDPE, 250 ml	0318-0250 N3
Sampling bottle PP, 250 ml	0319-0250 N3
Transport case for QuickPicker	3600-3000 N3
close-it seals page 78	

close-it control seal | essential for sampling bulk goods

- ▶ The labels are supplied in handy rolls
- ▶ The cross perforations allow each label to be separated from the roll individually
- ▶ close-it – standard size 95 x 95 mm
- ▶ close-it Maxi – 150 x 150 mm, for larger holes or longer tears in containers



close-it control seal | essential for sampling bulk goods

Taking samples from sacks, boxes, bags, etc. with sampling lances is a common and time-proven practice. This produces holes through which easily flowing bulk goods could escape from the container. With the close-it seal, this can be prevented in an uncomplicated manner.

close-it has been especially developed for this purpose. The label has a sandwich-type structure (aluminium/paper) and seals the container hermetically (vapour barrier). This virtually prevents hygroscopic powders from clumping together. The label is not just used to provide a hermetic seal. It is also used for providing quality control information (sampling date, release yes/no, name of tester, etc.). The labels are available in different colours. With printing in red, blue, green, yellow, black, neutral, without printing in white.

close-it can be written on with ball-point pen, pencil or felt-tip marker.

The rear of the label is coated with a powerful adhesive. This

means that close-it sticks firmly to most commercial containers, even to surfaces coated with fine powder, slightly moist or even frozen surfaces where conventional labels or adhesive tape will not stick.



Control seal close-it 95x95

Colour	Model	W x H mm	Pieces per roll	Item no.
red	printed	95 x 95	500	5303-0012 N4
yellow	printed	95 x 95	500	5303-0014 N4
blue	printed	95 x 95	500	5303-0015 N4
green	printed	95 x 95	500	5303-0016 N4
black	printed	95 x 95	500	5303-0011 N4
white	unprinted	95 x 95	500	5303-0002 N4

Accessories

Description	Item no.
close-it dispenser for labels with 95 x 95 mm	5303-9000 N4

Control seal close-it maxi 150x150

Colour	Model	W x H mm	Pieces per roll	Item no.
red	printed	150 x 150	250	5303-1012 N4
yellow	printed	150 x 150	250	5303-1014 N4
blue	printed	150 x 150	250	5303-1015 N4
green	printed	150 x 150	250	5303-1016 N4
black	printed	150 x 150	250	5303-1011 N4
white	unprinted	150 x 150	250	5303-1002 N4

Accessories

Description	Item no.
close-it dispenser for labels with 150 x 150 mm	5303-9100 N4

Control seal close-it food & pharma

In response to numerous requests from our customers, we have developed close-it food & pharma, a control seal with an adhesive approved for use with foodstuffs. The strength of the adhesive is almost as powerful as that of the original, the close-it from Bürkle, proven millions of times. close-it food & pharma also reliably prevents products from leaking out after sampling.

The adhesive complies with the European guidelines for foodstuffs. Just like the original, close-it food & pharma has a barrier layer of aluminium foil. This means that close-it food & pharma is suitable for sampling foodstuffs, pharmaceuticals, cosmetics, food additives, even frozen goods – in short, for all applications in which cleanliness is particularly important.

- ▶ According to FDA Guidelines
- ▶ Particularly suited for the food and pharma industry



Control seal close-it food & pharma 95x95

Colour	Model	W x H mm	Pieces per roll	Item no.
red	printed	95 x 95	500	5303-2017 N4
yellow	printed	95 x 95	500	5303-2020 N4
blue	printed	95 x 95	500	5303-2021 N4
green	printed	95 x 95	500	5303-2022 N4
black	printed	95 x 95	500	5303-2023 N4
white	unprinted	95 x 95	500	5303-2018 N4

Accessories

Description	Item no.
close-it dispenser for labels with 95 x 95 mm	5303-9000 N4

Control seal close-it food & pharma Maxi 150x150

Colour	Model	W x H mm	Pieces per roll	Item no.
red	printed	150 x 150	250	5303-3017 N4
yellow	printed	150 x 150	250	5303-3020 N4
blue	printed	150 x 150	250	5303-3021 N4
green	printed	150 x 150	250	5303-3022 N4
black	printed	150 x 150	250	5303-3023 N4
white	unprinted	150 x 150	250	5303-3018 N4

Accessories

Description	Item no.
close-it dispenser for labels with 150 x 150 mm	5303-9100 N4



YouTube





Besides the individually detachable close-it and close-it food & pharma closure labels, our repeatedly tested and proven control seal is now also available on a continuous roller. This helps you discover whether you require only a small piece, for example for closing a small hole, or for marking a specific point. Or whether you want to repair a long crack or a large hole quickly, reliably and easily. With its extremely strong adhesive strength, close-it^{tape} holds on the most diverse bases, where the glue effect of normal adhesive tape quickly reaches its maximum capacity.

For universal use, we have kept the adhesive tape close-it^{tape} in white with tear-off lines. It can be labelled with permanent ink and locks gas-proof. Available in the classic close-it design, as well as close-it^{tape} food & pharma, with a food-compatible adhesive.

- ▶ Customizable
- ▶ Different designs
- ▶ For larger holes or longer tears in containers

close-it tape

Width mm	Model	Length m	Item no.
95	standard	50	5303-0017 N4
150	standard	50	5303-1017 N4
95	food & pharma	50	5303-2019 N4
150	food & pharma	50	5303-3019 N4

Accessories

Description	Item no.
close-it dispenser for labels with 95 x 95 mm	5303-9000 N4
close-it dispenser for labels with 150 x 150 mm	5303-9100 N4

close-it | with individual customer-specific special printing

Custom-made according to the customer's specifications

The close-it control seal has many satisfied users who use close-it as a control seal, for documentation or as an informative label.

Your individual close-it

We would be happy to help you design your own close-it. Do you need final artwork for your draft? Or would you like to use our complete graphics service from draft stage through the print process? Our advertising department would be happy to consider any challenge!

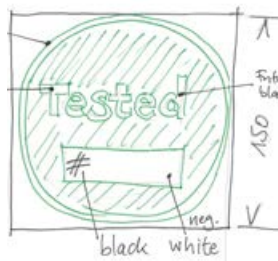

Your idea



Our draft



Finishing and print



Your close-it label

Shape and colour

Round, square, rectangular or other shape? Unusual contours can also be implemented! We would be pleased to provide you with a quote. Of course print is available in all colours, with either single or multiple colours.

Finishing

close-it can be manufactured with or without carrier paper perforations. Different numbers of close-it labels can be supplied in a single roll.

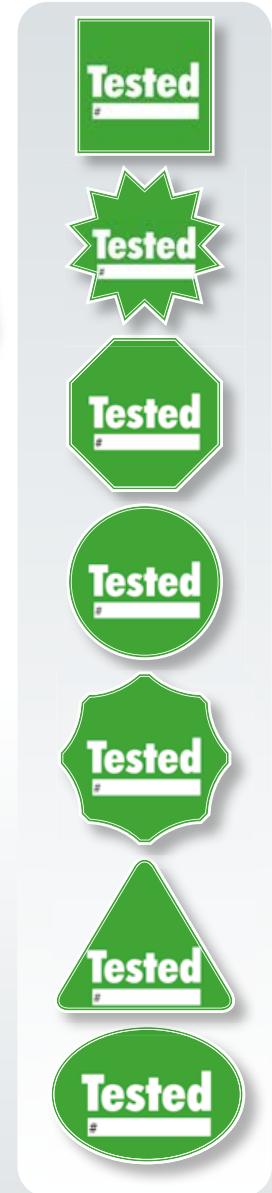

seal-it security seal | for retention samples



Retention samples are kept to provide a sample for comparison at a later date. The unambiguous proof that the retention sample is identical to the original sample is only possible with clearly marked and sealed containers. However, sealing is frequently not possible unless eyelets are present.

seal-it provides the solution! The seal-it self-adhesive label sticks to all conventional containers. Thanks to its unbelievable adhesive power it cannot be removed.

If a container opening is closed with seal-it, then the container cannot be opened without destroying the seal-it label. seal-it is additionally provided with several cross-perforations which immediately tear when manipulated like a motorcar tax disc.

seal-it can be used to securely seal bottles, sample bags, sacks, specimen bags, envelopes, etc. – in principle any type of container. The aluminium foil adapts seal-it to any container shape. The white labelling field on seal-it can be written on with all conventional writing tools with, for example, contents information, sampling date, name of operator, etc.

- ▶ Clear identification via numbers in sequence
- ▶ Integrated control label with the same number, for accompanying documents
- ▶ Format 178 mm long, 30 mm wide
- ▶ Tear-off perforation for each label

seal-it security seal

Length mm	Width mm	Colour	Pieces per roll	Item no.
178	30	red	500	5399-0003 N4

close-it dispenser



The close-it dispenser ensures safe storage and simple removal of the labels. The labels can be conveniently written on due to the marking plate.

- ▶ For close-it standard size 95 x 95 mm or close-it Maxi 150 x 150 mm

close-it dispenser

Model	Item no.
for labels with 95 x 95 mm	5303-9000 N4
for labels with 150 x 150 mm	5303-9100 N4



Tamper proof labels safe-it

The safety label safe-it is used as originality seal and as protection from manipulations of e.g. samples, retention samples, for transporting samples, sealing containers with important or dangerous chemicals in the lab as well as sealing letters, shipments and much more.

The initial opening of a package is made obvious and irrevocably visible with the seal guaranteeing originality, unauthorised opening can therefore be proven.

If the safety label is removed, it divides into separate layers. A pattern that was previously hidden appears on the surface and is irreversible. The glue leaves a residue on the surface that cannot be removed (a so-called void label). Once the label has been removed, it cannot be used again. Changing the label or modifying it afterwards are therefore not possible.

When the safe-it security seal has been broken, a silver checkerboard pattern appears on both the subsurface and surface of the sticker itself.

- ▶ With checkerboard pattern
- ▶ Visible proof of tampering



Tamper proof labels safe-it

W x H mm	Pieces per roll	Item no.
95 x 20	500	5303-5000 N4

Accessories

Description	Item no.
close-it dispenser for labels with 95 x 95 mm	5303-9000 N4

SampleSafe seal | secure your samples



Retained samples must be always secured against falsification and ambiguity in identification. Bottles with sealing eyelets should therefore be secured with SampleSafe seals.

The seals are made of stable polypropylene. The seals are to be uniquely identified with the serial 9-digit number.

The seal ring has a diameter of 2 mm, therefore SampleSafe seals also fit through small eyelets and slits. The seal tape is secured in the closure chamber by a metal insert made of stainless spring steel. The one-way tightening mechanism offers additional security against manipulation. It is not possible to forcibly open or manipulate the closure of the seal without leaving behind clear traces.

- ▶ Clear identification via numbers in sequence
- ▶ 100 seals (10 strips) per pack
- ▶ Protection against manipulation by stainless steel safety spring

SampleSafe seal

Length mm	Dia. mm	Colour	Pieces per pack	Item no.
260	2	red	100	5399-2902 N4



Sealable wide-necked bottles



Sturdy bottle with sealing eyelets on the screw cap and the bottle. Particularly suited for sending samples. Seals provide increased sample authenticity. Easy to fill due to wide opening. Particularly suitable for viscous media, powder, granules and pastes.

- ▶ HDPE
- ▶ Leakproof
- ▶ Easy to fill due to wide-necked opening

Sealable wide-necked bottles

Capacity ml	Container dia. mm	Neck dia. inside mm	Height with cap mm	Item no.
250	64	26.5	118	0322-0250 N3
500	78	40	147	0322-0500 N3
1000	100	50	186	0322-1000 N3
2000	120	50	230	0322-2000 N3



Accessories

Description	Item no.
SampleSafe seal, red, 100 pieces	5399-2902 N4

Pigment lance



Pigment lance to sample pigments, pastes and agglomerating bulk goods.

- ▶ With half-open flute 50 %, for heavily sticking products
- ▶ With quarter-open flute 25 %, for lightly sticking products
- ▶ Stainless steel AISI 316L (1.4404)
- ▶ 30 mm Ø

Use

1. Insert the lance to the required depth.
2. Turn the handle, the sample is collected into the open flute.
3. Pull back the lance.
4. Take out the sample.

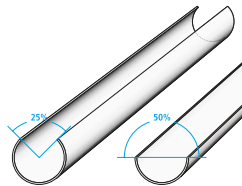

Pigment lance					
Flute length mm	Flute openings %	Volume ml	Total length mm	Item no.	
300	25	145	432	5369-0300	N4
300	50	85	432	5369-0310	N4
600	25	312	732	5369-0600	N4
600	50	179	732	5369-0610	N4
900	25	480	1032	5369-0900	N4
900	50	273	1032	5369-0910	N4

Valve lance



Sampler for all-layer samples of viscous, paste-like, semi-liquid substances, according to DIN 51750 pt. 3 and DIN EN ISO 15528. Different layers remain intact particularly with paste-like substances.

- ▶ Stainless steel AISI 316L (1.4404)
- ▶ 32 mm Ø
- ▶ Optimised opening mechanism (can be completely disassembled) for easy cleaning

Use

For viscous substances:

1. The valve lance is inserted all the way to the bottom, whilst being closed.
2. It is opened, closed and pulled out again.

For paste-like substances:

1. The valve lance is inserted all the way to the bottom, whilst being open.
2. It is closed and pulled out again.

Valve lance				
Length mm	Item no.			
550	5359-1600			N4
800	5359-1800			N4
Accessories				
Description	Item no.			
Transport case LxWxH 123x25x11 cm	3600-2120			N4

QualiRod conical



Conical hand-drill, conically shaped, with sharp cutting edges and a solid handle. Ideal for cutting out samples for quality control from soft, paste-like substances (cheese, butter, clay, soap, wax, etc.).

- ▶ Stainless steel AISI420B (1.4028)
- ▶ Sterilisable
- ▶ According to EN/ISO 707

QualiRod conical		
Drilling depth mm		Item no.
110		5311-0001 N4
150		5311-0002 N4
Accessories		
Description		Item no.
Transport case, inner dimensions 258x178x45 mm close-it food&pharma page 80		3600-0021 N3

QualiRod cylindrical



Cylindrical hollow drill with a sharp cutting edge, can easily be driven into paste-like and semi-solid substances. The samples cut out are subsequently removed with the appropriate push-rod ejector. Total length 260 mm. Inner Ø 8 mm, outer Ø 10 mm.

- ▶ Stainless steel AISI 304 (1.4301)
- ▶ Sterilisable
- ▶ Inner Ø 8 mm, outer Ø 10 mm

QualiRod cylindrical		
Drilling depth mm		Item no.
200		5311-0101 N4
Accessories		
Description		Item no.
Transport case, inner dimensions 258x178x45 mm		3600-0021 N3

Stainless steel spatula



Sample spatula made of stainless steel AISI 316L (1.4404). The highly stable and solid design of the spatula allows it to pierce solid substances or sacks and Big-Bags. The spatula is made of premium stainless steel, high-gloss polished and completely welded, thus completely free of undercuts. It is therefore ideally suited for taking samples of powders, granulates and pasty media, especially in food and pharmaceutical applications.

- ▶ Made completely of stainless steel AISI 316L (1.4404)
- ▶ Very sturdy
- ▶ Easy to clean
- ▶ Autoclavable
- ▶ Can be flame-sterilized
- ▶ High-gloss polished

Palette knife spatula



Similar to a pallet or dispensing chemist's spatula, this palette knife spatula is suitable for applying or distributing viscous media such as pastes and creams, or for spreading them smoothly. The high-quality stainless steel spatula is manufactured with no edges or crevices. That makes cleaning easier and prevents product residue and cleaning agents from accumulating. The spatula has a long, narrow, high-gloss polished blade that facilitates precise work. The sturdy handle fits comfortably in the hand. The laboratory spatula is suitable for use in chemical and pharmaceutical applications.

- ▶ Stainless steel AISI 304 (1.4301)
- ▶ Very sturdy



Stainless steel spatula

Insertion depth mm	Volume ml	Total length mm	Item no.
188	50	300	5383-1000 N4



Palette knife spatula stainless steel

L x W mm	Item no.
200 x 21	5386-0010 N4
250 x 25	5386-0012 N4



Spatula



Universal instrument for collecting, dividing and mixing pastes, creams etc.

- ▶ Blade made of stainless steel AISI 304 (1.4301)
- ▶ Wooden handle

Spatula

Length mm	Item no.
180	5313-0180 N4
300	5313-0300 N4

Mini ViscoSampler | for small quantities



Sampler for viscous substances such as pastes, mud, creams, oils. The sample is drawn in using the pump rod and directly conveyed to a sampling container. Easy cleaning for flawless sampling. Depending on the viscosity, the removable suction tip can be fitted with suction drills of 2 mm to 6 mm.

- ▶ Stainless steel AISI 316L (1.4404), piston PTFE
- ▶ Sterilisable
- ▶ Ideal for the pharmaceutical and cosmetics industry
- ▶ Incl. suction tip 2 mm
- ▶ 15 mm Ø

Mini ViscoSampler

Length cm	Chamber volume ml	Item no.
60	30	5341-1060 N4
100	50	5341-1100 N4
150	75	5341-1150 N4

Accessories

Description	Item no.
Suction heads for Mini ViscoSampler, suction drill 2 mm	5341-1002 N4
Suction heads for Mini ViscoSampler, suction drill 4 mm	5341-1004 N4
Suction heads for Mini ViscoSampler, suction drill 6 mm	5341-1006 N4
Drain safety stand (see page 50)	5618-1000 N4



ViscoSampler | sample collector for medium viscosity substances



ViscoSampler with powerful suction for viscous media. The media is drawn up and discharged using the suction flask. Made of ultra-pure, chemically inert PTFE/FEP for contamination-free sampling. Specially developed for viscous substances such as slurries, silt, wet clay and soil samples, soil sediments, oils, emulsions, creams etc.

Easy cleaning - all surfaces are poreless and without crevices. Dirt accumulation is prevented. Only round screw threads tried and tested in the field of food hygiene are used. Disassembly and cleaning are extremely simple.



QualiSampler set

The handy set, which comes complete with carrying case, combines the LiquiSampler and the ViscoSampler with practical accessories.

Models in PP or PTFE/FEP.

- ▶ QualiSampler set consisting of:
- ▶ LiquiSampler, 100 cm
- ▶ ViscoSampler, 100 cm
- ▶ Case, five bottles, cleaning brush

QualiSampler set

Material	Item no.
PP	5330-1000 N4
PTFE / FEP	5330-1001 N4

ViscoSampler

Material	Volume ml	Immersion depth cm	Dia. mm	Item no.
PP, transparent	160	60	32	5331-1060 N4
PP, transparent	300	100	32	5331-1100 N4
PP, transparent	650	200	32	5331-1200 N4
PTFE/FEP, transparent	160	60	32	5331-2060 N4
PTFE/FEP, transparent	300	100	32	5331-2100 N4
PTFE/FEP, transparent	650	200	32	5331-2200 N4



Accessories

Description	Item no.
Cleaning brushes 25 mm dia., length 100 cm	5304-0100 N4
Drain safety stand (see page 50)	5618-1000 N4

LiquiSampler | sample collector for liquids



LiquiSampler for liquids, according to DIN EN ISO 15528. Made of ultra pure and chemically inert PTFE/FEP or PP for contamination-free sampling.

Sampling from open and closed containers, barrels, tanks, silos, water courses. Suitable for all commercially available barrels and containers with opening of at least 32 mm in diameter.

Easy cleaning - all surfaces are free of pores and crevices, preventing accumulation of dirt. Only round screw threads proven in foodstuffs hygiene are used. Disassembly and cleaning are extremely simple.

- ▶ Practical one-handed use at the push of a button
- ▶ With scraping ring for marking of depth and cleaning
- ▶ Transparent
- ▶ Available in PTFE/FEP or PP transparent
- ▶ Point sampling, all-layer sampling and bottom sampling possible

Use

All-layer sample

1. Slowly insert the LiquiSampler into the liquid with the button pressed.
2. Release the push-button, the valve closes.
3. Withdraw the lance and take out the sample.

Point sampling/bottom sample

1. Insert the LiquiSampler to the targeted point/to the ground with closed valve.
2. Press the button - the liquid flows in.
3. Release the push-button, the valve closes.
4. Pull out the LiquiSampler, take out the sample.



LiquiSampler								
Material	Volume ml	Immersion depth cm	Dia. mm	Item no.				
PP, transparent	150	60	32	5330-1060 N4				
PP, transparent	250	100	32	5330-1100 N4				
PP, transparent	500	200	32	5330-1200 N4				
PTFE/FEP, transparent	150	60	32	5330-2060 N4				
PTFE/FEP, transparent	250	100	32	5330-2100 N4				
PTFE/FEP, transparent	500	200	32	5330-2200 N4				
Accessories								
Description								Item no.
Cleaning brushes 25 mm dia., length 100 cm								5304-0100 N4

Dip Sampler, plunging siphon



Dip sampler for simple removal of liquid samples. Good view due to transparent tubes. Upper end with reflux valve, lower end with ball valve.

- ▶ PP, transparent
- ▶ Dip sampler, item no. 5315-0200, steplessly extendable from 100 cm to 200 cm
- ▶ All-layer and point sampling possible



Use

All-layer sample

1. Insert the dip sampler slowly into the liquid with the valve open.
2. Close valve.
3. Pull the dip sampler back and take out the sample.

Point sample/bottom sample

1. Insert the dip sampler to the targeted point/to the ground with closed valve.
2. Open the valve - the liquid flows in.
3. Close the valve.
4. Pull out the dip sampler, take out the sample.



Dip Sampler, plunging siphon

Volume ml	Immersion depth cm	Tube Ø mm	Item no.
140	50	25	5315-0050 N4
280	100	25	5315-0100 N4
500	100 - 200	25	5315-0200 N4



Disposable plunging siphon



If strongly adhesive liquids are sampled, it can be a lot less expensive to dispose of the sampler than to carry out a complicated cleaning process. The disposable dip sampler were developed especially for this purpose. They are made of PE, transparent and the contents are easily visible. PE provides a surface that resists adhesion of the sample material, minimising sample retention on the dip sampler.

Use

1. Insert the dip sampler into the liquid and fill it.
2. Close the thumbhole above the handle using your thumb.
3. Take out the dip sampler and empty the liquid into the sample bottle.

Disposable plunging siphon				
Volume ml	Immersion depth cm	Total length cm	Tube Ø mm	Item no.
75	35	50	27	5387-0050 N4
175	60	75	27	5387-0075 N4
275	85	100	27	5387-0100 N4

PTFE Scoop



All parts coming into contact with the sample medium are made of pure white PTFE. Completely inert against all substances (with the exception of elementary fluoride). The rod is stabilised with a steel core which is completely encapsulated in PTFE. The 60 cm long rod can be extended to 120 cm by adding another component. The scoop PTFE with 10 ml has a strong rod with a length of 155 mm.

PTFE Scoop			
Capacity ml	Dia. mm	Height mm	Item no.
10	25	34	5389-0010 N2
100	55	65	5389-0100 N2
250	70	95	5389-0250 N2
500	80	125	5389-0500 N2
1000	105	155	5389-1000 N2

Accessories	
Description	Item no.
Extension for PTFE scoop, 60 cm	5389-0001 N2

Chemistry scoop



Scoop for aggressive liquids, complete with strong handle, entirely made of polypropylene.

- ▶ Rod length 100 cm, Ø 20 mm
- ▶ Without metal parts

Chemistry scoop

Capacity ml	Item no.	
250	5353-0250 N4	
600	5353-0500 N4	
1000	5353-1000 N4	

Stainless steel scoop



In contrast to conventional scoops, the stainless steel scoop has no openings, undercuts or crevices in which residues could collect. Pore-free finishing produced by high-quality laser welding seams. The stainless steel scoop can be flame-sterilised and can therefore be made completely germ-free.



- ▶ Scoop made of stainless steel AISI 304 (1.4301), complete with rod
- ▶ Sterilisable by flame sterilisation or steam sterilisation



Stainless steel scoop

Total length cm	Capacity ml	Item no.			
115	1000	5354-1000 N4			

TeleScoop | for industry and water treatment



TeleScoop is a versatile sampling system with exchangeable tools for a wide range of applications. The tools (angular beaker, pendulum beaker, bottle holder, stainless steel beaker and dip net) are attached to the telescopic rod by a practical snap-in joint. Ideal for sampling from baths, tanks, shafts, open water courses etc. Sampling depths down to 6 m can be reached with the adjustable telescopic aluminium rod.

- ▶ For industry and water treatment



Different tools can be attached to the telescopic rod (snap-in joint). The individual rods have been provided with an end stop. This means that one rod cannot accidentally slip out of another rod. The telescopic rods cannot be rotated radially, which means even better handling!

Telescopic rod 5355-0280, extremely short model – yet extendable up to 280 cm. Fits into every car boot!

- ▶ Increased telescopic rod rigidity by using cold-rolled profile rod
- ▶ Springs made of stainless steel



Telescopic rod

Length infinitely variable from	No. of rods	Item no.	
65-120 cm	2	5355-0120	N4
70-180 cm	4	5355-0180	N4
125-250 cm	2	5355-0250	N4
95-280 cm	4	5355-0280	N4
115-300 cm	3	5355-0300	N4
165-450 cm	3	5355-0450	N4
175-600 cm	4	5355-0600	N4

Accessories

Description

Sampling tools for telescopic rods page 96/97

TeleScoop | for industry and water treatment



①

The beaker is adaptable to different container shapes by adjustable angle setting (up to 90°).

► Polypropylene



②

This beaker automatically swings to a horizontal position. Nothing can be spilt. Suitable therefore for deep and narrow shafts (Ø 150 mm).

► Polypropylene



③

This beaker automatically swings to a horizontal position. Nothing can be spilt. Suitable therefore for deep and narrow shafts (Ø 130 mm).

► Stainless steel AISI 304 (1.4301)



④

Holds all bottles up to 88 mm Ø. Plastic, glass or metal bottles can be securely filled in this way. Angle steplessly adjustable up to 90°.

► With universal quick tightening strap
► Polypropylene/PA

Model	Capacity ml	Item no.
① Scoop angular beaker	600	5354-0050 N4
① Scoop angular beaker	1000	5354-0100 N4
① Scoop angular beaker	2000	5354-0200 N4
② Pendulum beaker PP	600	5354-5050 N4
② Pendulum beaker PP	1000	5354-5100 N4
② Pendulum beaker PP	2000	5354-5200 N4
③ Pendulum beaker AISI 304	1000	5354-3000 N4
④ Bottle holder	750	5354-4100 N4

Accessories

Description

Telescopic rods see page 95

TeleScoop | for industry and water treatment



Beaker with scraper, contents 1000 ml. Ideal for powder, granules, pastes, mud.

Sampling dipper made of stainless steel V2A (1.4301) with extended, completely closed handle.

Catch net for taking solid and organic samples from water courses.

Catch net for taking solid and organic samples from water courses.

- ▶ Sterilisable
- ▶ Stainless steel AISI 304 (1.4301)

- ▶ Closed handle with immersion depth up to approx. 50 cm
- ▶ Beaker capacity 1000 ml

- ▶ PVC/PA blue
- ▶ L 310 x W 280 mm
- ▶ Mesh width 2–5 mm

- ▶ PP/PA blue
- ▶ L 190 x W 430 mm
- ▶ Net depth 250 mm
- ▶ Mesh width 2–5 mm



Telescopic rods see page 95.

Model	Capacity ml	Item no.
⑤ Stainless steel beaker	1000	5354-2000 N4
⑥ Stainless steel beaker, extended	1000	5354-2010 N4

Model	Item no.
⑦ Surface catch net	5354-5020 N4
⑧ Depth catch net	5354-5010 N4

Liquid-Sampler | single hand operation



Sampler for thin to viscous liquids. Easy use with one-handed operation. With discharge funnel for safe filling of the sample bottles.



► Material AISI 316L (1.4404)



The valve is opened with the thumb to empty the sample.



The valve is opened by attaching the sample container to empty the sample.



Liquid-Sampler, open with thumb

Total length cm	Container dia. mm	Capacity ml	Item no.
46	32	50	5326-0001 N4
54	32	100	5326-0002 N4



Liquid-Sampler, place onto bottle

Container dia. mm	Total length cm	Capacity ml	Item no.
32	45.5	50	5326-0003 N4
32	53.5	100	5326-0004 N4



Sampler Liquid CupSampler



Use

1. Place the collector at the desired depth.
2. Open the lid using the handle. The liquid flows in.
3. Close the filled collector and remove it.
4. Empty the sample into the sample bottle.

It is possible to carry out point sampling of liquids of varying viscosity with the stainless steel AISI 316L (1.4404) Liquid CupSampler. Media-containing particles can also be sampled without difficulty. The sampler can be used in the fields of chemistry, foodstuffs and cosmetics.

The cup can be unscrewed from the stem, allowing easy cleaning.



ChemoSampler | for acids, alkalis, detergents



The ChemoSampler was developed for sampling aggressive liquids, e.g. acids, alkalis, detergents. The samples are drawn directly into the screw-on original sampling bottle. The tamper-proof bottle closure of these bottles with original safety ring ensures unadulterated sample transport. Samples can be taken from depths of as much as 200 cm, e.g. from tanks, silos or tankers, by using the extension rod.

- ▶ PP, grey
- ▶ Resistant to acids and alkalis
- ▶ Incl. sample bottle PE 1000 ml
- ▶ Extension rod 100 cm and two bottle sizes available as accessories.

! Attention! Make sure to pay attention to the "List of Chemical Resistance"!

Sampler Liquid CupSampler

Capacity ml	Container dia. mm	Total length cm	Item no.
100	55	100	5357-0001 N4

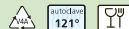

ChemoSampler

Item no.	
5336-1000	N4

Accessories

Description	Item no.
Extension for ChemoSampler 100 cm	5336-0100 N4
Sampling bottle PE, 500 ml	0342-0500 N3
Sampling bottle PE, 1000 ml	0342-1000 N3

Vampire Sampler | for sampling liquids in the field

- ▶ Battery-powered hose pump for sampling liquids from depth
- ▶ Easy cleaning and exchangeable hoses prevent impurities
- ▶ Suction depth up to 5 metres
- ▶ Consisting of a drive unit, pump head, pump hoses (30 cm, Marprene/silicone), suction hose (5 m, PE), hose connector (PP), sample bottle (250 ml, LDPE), bottle basket, two rechargeable batteries and battery charger

Vampire Sampler | for sampling liquids in the field

The Vampire sampler can be used to take samples from liquids easily, even from deeper depths.

The portable sampling pump consists of a mains-independent drive unit, a pump head and a delivery hose.

The medium being sampled is directed via the closed hose system directly into the sample container. The sample only comes in contact with the hoses and the sample bottle. This excludes the risk of impurities and contamination because the hoses are easy to clean and can also be replaced easily if necessary.

The self-priming peristaltic pump is also suitable for substances that are dirty or contain particles with a maximum viscosity of 500 mPas. The gently pumping does not change the sample. Thanks to a suction depth of 5 meters, the battery-powered Vampire sampler easily pumps samples, even from sampling points at lower depths, for example from barrels, tanks, wells, water traps or wastewater and sewage treatment plants.

The portable sampler is easy to handle and carry. The pump attachment is easy to attach to the drive unit and the hoses can be changed quickly. The sample bottle is fastened directly onto the sampling instrument by a bottle basket. The hose pump is perfect for sampling liquid substances in industrial applications such as beverage production or monitoring water quality for environmental protection.



Vampire Sampler



Item no.
5327-1000

N2

Accessories

Description	Item no.
Suction hose Marprene, 1 m	5327-0508 N2
Sampling bottle LDPE 500 ml	0318-0500 N3
Sampling bottle LDPE 1000 ml	0318-1000 N3
Suction hose PE on roll 6 x 8 mm, roll with 10 m	8805-0608 N3
Suction hose PE on roll 6 x 8 mm, roll with 100 m	8878-0608 N3
Basket for sample bottles 500 ml, Ø 84 mm	5302-2051 N2
Basket for sample bottles 1000 ml, Ø 100 mm	5302-2101 N2

MiniSampler | taking samples – comfortable, quick and clean sampling



With the vacuum sampler MiniSampler, the sample liquid only comes into contact with the suction hose and the original sample bottle. The possibility of cross-contamination is greatly reduced. Immediately after taking the sample, the bottles are sealed. The disposable suction hose can quickly be replaced. This guarantees that the samples are never contaminated. If necessary, a new hose can be used for every single sample.

Due to its small diameter (8 mm), the hose can reach narrow, seemingly inaccessible sampling areas.

Two models:

PE MiniSampler for general sampling, max. suction height 5 m*

PTFE MiniSampler for ultra-pure sampling, max. suction height 5 m*

* depending on the medium

- ▶ Also suitable for viscous oils
- ▶ Complete in a handy transport case

Use

1. Insert the hose and the bottle into the pump.
2. Insert hose end to desired sample depth.
3. Move the pump piston back and forth and collect the sample.
The liquid flows directly into the bottle.
4. Take off the filled bottle, close and label it.

⚠ Not for aggressive acids. Vapours could destroy pump.

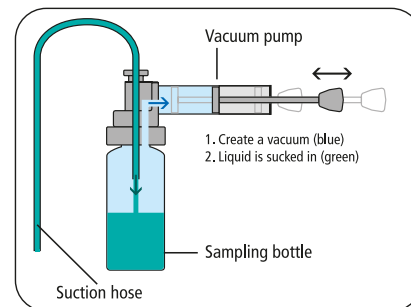

MiniSampler PE | for general sampling



Ideal for general sampling from barrels, canisters, tanks etc. MiniSampler PE complete with accessories in transport case, contents: Vacuum pump, 10 PE bottles 100 ml, 10 m PE suction hose 6 x 8 mm, 1 hose cutter, 1 stainless steel hose weight made of AISI 304 (1.4301)/brass nickel-plated, 20 seal-it bottle seals.

MiniSampler PE			
Item no.	5305-0100		N4
Accessories			
Description	Item no.		
MiniSampler pump with adapter PP	5305-0010	N4	
MiniSampler standard pump	5305-0011	N4	
PTFE MiniSampler adapter for glass thread GL 45	5305-0209	N4	
MiniSampler adapter PTFE for sample tubes PFA 6205-0180	5305-1020	N2	
Hose cutter	0006-9506	N3	
Sampling bottle HDPE, 100 ml	0340-0100	N3	
Sampling bottle HDPE, 250 ml	0340-0250	N3	
Suction hose PE on roll 6 x 8 mm, roll with 10 m	8805-0608	N3	
Suction hose PE on roll 6 x 8 mm, roll with 100 m	8878-0608	N3	

MiniSampler PTFE | for ultrapure sampling



Ideal when maximum purity is needed. MiniSampler PTFE complete with accessories in its transport case, contents: Vacuum pump, 1 sample bottle PFA 180 ml, 5 m PTFE suction hose 6 x 8 mm, 1 hose cutter, 1 stainless steel hose weight made of AISI 304 (1.4301)/brass nickel-plated, 20 seal-it bottle seals.

MiniSampler PTFE			
Item no.	5305-0110		N4
Accessories			
Description	Item no.		
MiniSampler pump with adapter PP	5305-0010	N4	
MiniSampler standard pump	5305-0011	N4	
PTFE MiniSampler adapter for glass thread GL 45	5305-0209	N4	
MiniSampler adapter PTFE for sample tubes PFA 6205-0180	5305-1020	N2	
Hose cutter	0006-9506	N3	
Sample boxes PFA, 180 ml	6205-0180	N3	
Suction hose PTFE on roll 6 x 8 mm, roll with 5 m	8804-0608	N3	

ProfiSampler | vacuum-operated sample collector for robust industrial use



While the MiniSampler is designed for laboratory use, the ProfiSampler has been specially developed for rough industrial use.

Applications

Sampling liquids in barrels, tanks, lorries, railway goods wagons, ships, water courses, ground water, etc.

Vacuum samplers have the advantage that the sample liquid only comes into contact with the suction hose and the original sample bottle. The possibility of cross-contamination is greatly reduced. Immediately after taking the sample, the bottles are sealed. The disposable suction hose can quickly be replaced. This guarantees that the samples are always authentic. If necessary, a new hose can be used for every single sample.

Due to its small diameter (8 mm), the hose can reach narrow, seemingly inaccessible sampling areas.

The ProfiSampler can be extended with useful accessories developed in practice.

⚠ Attention! Make sure to pay attention to the "List of Chemical Resistance"!

- ▶ Three feet guarantee that the ProfiSampler stands safely
- ▶ Fill level control, automatic return flow and overflow protection through built-in venting valve
- ▶ Available with suction hose in PE, PA and PTFE wherever the highest degree of purity is required
- ▶ Can be supplied with straight suction tubes for simpler sampling, incl. transport case for tidy transport and disposal of the suction tubes
- ▶ Suction volume 200 ml, suction pressure 0.5 bar
- ▶ Suction height from liquid surface 5 m WS
- ▶ Sample bottles available in different materials and sizes

Profi Sampler aluminium



ProfiSampler | vacuum-operated sample collector for robust industrial use

① ProfiSampler Aluminium

ProfiSampler aluminium for solvents and flammable liquids in Explosion Categories IIA, IIB and IIC. With bottle thread GL 45 (suitable for Schott glass bottles 100 ml to 1000 ml).

When taking samples of flammable liquids, the device must be earthed. For this, earthing cable and, possibly in addition, anti-static set should be used, see accessories.

ProfiSampler aluminium, consisting of: Vacuum pump made of aluminium, with feet, venting valve and bottle thread GL 45 with glass bottle 500 ml, 5 suction tubes PA black (220 cm long, electrically conductive), hose cutter, brass hose weight, 20 seal-it bottle seals, earthing cable.

② Profi Sampler PP

ProfiSampler PP for general samples, for weak acids, alkalis, detergents, chemical baths. Made of solid, chemical resistant Polypopylene.

ProfiSampler PP, consisting of: Vacuum pump, made of solid PP, with feet, venting valve and bottle thread GL 40, 1 PP bottle 250 ml, 10 m PE suction hose (roll), 1 hose cutter, 1 stainless steel hose weight made of AISI 304 (1.4301), 20 seal-it bottle seals.



③ Straight suction tubes for ProfiSampler

have the advantage that they are not slightly bent as is the standard tubing (from the roll) and can therefore be immersed absolutely vertically into the container. The suction tubes are available in transparent PE for general sampling and black PA for flammable liquids in VbF Hazard Category AI (electrically conducting). Diameter 6 x 8 mm. Contamination banned! In practice the low-priced tubes are only used once. They are then disposed of, instead of being subjected to a costly cleaning process. The tubes are not autoclavable.

④ Transport case for straight suction tubes

Suction tube case for the practical transport of new suction tubes and the safe storage of used ones. Suitable for 100 suction tubes, 220 cm long.

① ProfiSampler Aluminium

① ProfiSampler Aluminium			
Item no.	5305-1100		N4
Accessories			
Description	Item no.		
Glass sampling bottle 100 ml, GL 45	5314-0010	N3	
Glass sampling bottle 250 ml, GL 45	5314-0025	N3	
Glass sampling bottle 500 ml, GL 45	5314-0050	N3	
Glass sampling bottle 1000 ml, GL 45	5314-0100	N3	
③ Straight suction tube, PE transparent, 200 cm, 10 pieces	5305-1022	N4	
③ Straight suction tube, PA black, electrical conductive, 220 cm, 10 pieces	5305-1024	N4	
④ Transport case for straight suction tubes	5305-1029	N4	
Anti-static set	5602-1000	N4	
Suction hose PE on roll 6 x 8 mm, roll with 10 m	8805-0608	N3	
Suction hose PE on roll 6 x 8 mm, roll with 100 m	8878-0608	N3	
Suction hose PTFE on roll 6 x 8 mm, roll with 5 m	8804-0608	N3	

② Profi Sampler PP

② Profi Sampler PP			
Item no.	5305-1000		N4
Accessories			
Description	Item no.		
③ Straight suction tube, PE transparent, 200 cm, 10 pieces	5305-1022	N4	
③ Straight suction tube, PA black, electrical conductive, 220 cm, 10 pieces	5305-1024	N4	
④ Transport case for straight suction tubes	5305-1029	N4	
PP sampling bottle ProfiSampler	0319-0252	N3	
Suction hose PE on roll 6 x 8 mm, roll with 10 m	8805-0608	N3	
Suction hose PE on roll 6 x 8 mm, roll with 100 m	8878-0608	N3	

UniSampler with hose



UniSampler with PVC hose and hose weight made of stainless steel. For deep, hard-to-reach places. The mass of the metal tube drags the hose to any depth.

- ▶ Suction hose PVC, 2.50 m long
- ▶ Complete in a handy transport case incl. sample bottle PP 1000 ml, vacuum pump, universal bottle adapter, hose weight made of AISI 304 (1.4301), 20 seal-it bottle seals
- ▶ Universal bottle adapter made of PVC, for bottle necks Ø 24 mm, 32 mm, 39 mm and 50 mm nominal dimension, for sample bottles 100–1000 ml

Use

1. Lower the suction hose to the required depth.
2. Attach the adapter to the sampling bottle.
3. Create a vacuum using the handpump and collect the sample.
4. Remove the filled sample bottle, close and label it.

UniSampler with hose	
Item no.	
5314-2000	N4
Accessories	
Description	Item no.
Suction hose for replacement PVC, 2,5 m	5314-2002 N4
Sampling bottle PP, 100 ml	0319-0100 N3
Sampling bottle PP, 500 ml	0319-0500 N3
Sampling bottle PP, 1000 ml	0319-1000 N3
Sampling bottle PP, 250 ml	0319-0250 N3

UniSampler "Ex"



Sampler especially developed for sampling flammable liquids of Hazard Category A1 (VbF, e.g. fuel). Glass bottle and hose are connected in such a way that they conduct electricity and are earthed via an earthing cable.

- ▶ Complete in a handy transport case incl. 4 m hose (NBR), glass bottle 1000 ml, bottle adapter, bottle stand, vacuum pump, earthing cable and hose-weight made of brass
- ▶ PTB approval D-333-009 618/00

Use

1. Earth the device.
2. Lower the suction hose to the required depth.
3. Attach the adapter to the sampling bottle.
4. Create a vacuum using the handpump and collect the sample.
5. Remove the filled sample bottle, close and label it.

The UniSampler "Ex" was developed in co-operation with the quality association Tankschutz e.V. (non-profit association for tank protection).

UniSampler "Ex"	
Item no.	
5314-3000	N4
Accessories	
Description	Item no.
Glass sampling bottle 1000 ml, GL 45	5314-0100 N3

UniSampler with suction lance



Use

1. Set the desired sampling depth by moving the suction lance.
2. Attach the adapter to the sampling bottle.
3. Lower the suction lance into the medium.
4. Create a vacuum using the hand-pump and collect the sample.
5. Remove the filled sample bottle, close and label it.

The collection lance consists of an inner tube and an outer tube. The suction position can be varied steplessly with the outer tube within a height of 0 to 48 cm. The total length of the telescopic suction tube is 100 cm.

- ▶ Suction tube PP, suction hose PVC
- ▶ Incl. 5 sample bottles each PP 250 ml and 500 ml, vacuum pump, universal adapter for sample bottles, 20 seal-it bottle seals
- ▶ Universal bottle adapter made of PVC, for bottle necks Ø 24 mm, 32 mm, 39 mm and 50 mm nominal dimension, for sample bottles 100–1000 ml

UniSampler with suction lance

Item no.

5314-1000

N4

Accessories

Description

Sampling bottle PP, 100 ml

Sampling bottle PP, 500 ml

Sampling bottle PP, 1000 ml

Sampling bottle PP, 250 ml

Item no.

0319-0100 N3

0319-0500 N3

0319-1000 N3

0319-0250 N3

Bürkle - Behind the scenes

There are many ways for ordering at Bürkle - but all roads lead to the Sales department.



www.buerkle.de

You can reach us around the clock!



Are you not sure whether a product is the right for you? Just ask us:

+49 (0) 7635 / 8 27 95 - 0



As soon as you have ordered a product, Production, and Materials Management take over personally.



By the way: If your product is in stock and you order before 1.00 p.m., the package leaves our store the same day.



Are you in a hurry? We also offer express deliveries.

Dipping bottles



Dipping containers are used in various areas to collect liquids for sampling. Bürkle produces the most comprehensive collection of dipping containers by a long way, the right product for every use as it were. Bürkle offers dipping bottles and immersion cylinders for sediments, for the area of environmental issues, for chemically aggressive products, for petrochemistry, for the ex protection area etc. The dipping bottles for the Ex protection area are made of nickel-plated brass, therefore they do not oxidise. Dipping vessels can be used for point sampling, all-layer samples and bottom sampling. Dipping vessels are heavy. Lowering requires the use of special manually-operated drum reels with a large winding diameter. Other manually-operated drum reels place too much strain on the user's wrist and could represent a health hazard. Lowering cables and chains made from different materials, as well as manually-operated drum reels, also for Ex-proof applications, available as accessories.

! Observe Ex-proof guidelines when sampling flammable liquids. Only use conductive lowering cables made of nonspark-producing material and conductive hand reels with grounding connection.

Dipping bottle

Dipping bottle with glass container for sampling in sewage plants, for mud and water samples. For testing crude oil, liquid mineral oil products, fuels, special and test fuels, fuel oils, petroleum and liquid lubricants of Hazard Categories IIA and IIB. Completely made from non-spark producing materials. Dipping frame made of nickel-plated brass, easy-click closure made of electrically conductive polyamide.

- ▶ With Easy-Click, safe and practical closure for a rapid bottle exchange
- ▶ High weight (3.2 kg) for fast lowering
- ▶ Bottle made of transparent glass 1000 ml contents
- ▶ Height with handles 330 mm
- ▶ Tested for use in the Ex protection zone 0

! Please order the required lowering cable separately (page 112).

Use

1. Lower the dipping bottle to the required depth.
2. Pull chain/cable with a short, powerful jerk, the stopper opens.
3. The sample flows into the bottle.
4. Raise the bottle with the chain/ cable.
5. Open the Easy-Click closure, remove the bottle.

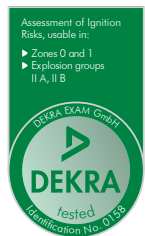

Dipping bottle

Capacity ml	Dia. mm	Item no.
1000	148	5365-4000 N4



Dipping bottle Ex

Dipping bottle for testing mineral oil products Category A, Explosion Categories IIA, IIB and IIC, crude oil, liquid mineral oil products, fuels, special and test fuels, fuel oils, petroleum and liquid lubricants. Completely made from non-spark producing materials, nickel-plated

- ▶ Screw-off bottle head – easy cleaning
- ▶ Robust handle
- ▶ High weight (3.3 kg) for fast lowering
- ▶ Height with handles 443 mm
- ▶ Tested for use in the Ex protection zone 0

Please order the required lowering cable separately (page 112).



Use

1. Lower the dipping bottle to the required depth.
2. Pull chain/cable with a short, powerful jerk, the stopper opens.
3. The sample flows into the bottle.
4. Raise the bottle with the chain/cable.
5. Empty the bottle.



Dipping bottle Ex

Capacity ml	Dia. mm	Item no.
1000	89	5365-3000 N4



Immersion cylinder

Immersion cylinder for sampling crude oil, liquid mineral oil products, fuels, special and test fuels, fuel oils, petroleum and liquid lubricants in Explosion Categories IIA, IIB and IIC. Completely made from non-spark producing materials, nickel-plated.

- ▶ Screw-off top enables easy cleaning
- ▶ High weight for fast lowering
- ▶ Robust handle
- ▶ Tested for use in the Ex protection zone 0

Please order the required lowering cable separately (page 112).

Use

Point sampling

1. Two lowering cables are required for this (bearer cable and hauling cable).
2. Lower the immersion cylinder to the required depth.
3. When the target has been reached, pull on the hauling cable, the valve opens.
4. The sample flows into the bottle.
5. Release the hauling cable. The valve closes. Pull the cylinder back on the bearer cable.
6. Empty the cylinder via the valve at the bottom.

Bottom sampling

1. Lower the immersion cylinder on the cable to the ground.
2. The valve opens automatically because of the immersion cylinder's own weight.
3. The sample flows into the cylinder.
4. Pull the cylinder back on the cable, the valve closes independently.
5. Empty the cylinder via the valve at the bottom.



Immersion cylinder

Capacity ml	Dia. mm	Height mm	Weight g	Item no.
500	75	300	3000	5365-7500 N4
1000	75	450	4300	5365-7000 N4



Dipping vessel

Dipping vessel for taking all-layer samples from tanks, tank wagons, water courses, water purification plants.

- ▶ With Easy-Flow, the flow optimised flow valve
- ▶ High weight for faster lowering
- ▶ Contents 1000 ml
- ▶ Height with handles 427 mm
- ▶ Made of non-spark producing brass or stainless steel AISI 304 (1.4301) for Ex area
- ▶ Tested for use in the Ex protection zone 0, Explosion Categories IIA, IIB and IIC

Please order the required lowering cable separately (page 112).



Use

1. When the dipping vessel is lowered, the liquid constantly runs through it.
2. When it is pulled back, both valves close automatically.
3. Emptying at the top via the open flaps.

Dipping vessel

Material	Dia. mm	Weight g	Item no.
brass	82	2300	5365-1000 N4
stainless steel AISI 304	82	2000	5365-2000 N4

Mini immersion cylinder

For sampling liquids in narrow places where access is difficult. Can also be used in curved dipping tubes and barrels with narrow openings.

- ▶ Diameter only 32 mm
- ▶ Weight 330 g
- ▶ Stainless steel AISI 304 (1.4301)
- ▶ Screw-off top enables easy cleaning
- ▶ Tested for use in the Ex protection zone 0, Explosion Categories IIA and IIB

Please order the required lowering cable separately (page 112).

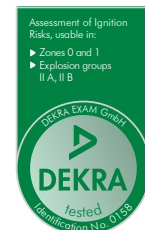

Use

1. When the dipping vessel is lowered, the liquid constantly runs through it.
2. When it is pulled back, both valves close automatically.
3. It can be emptied via the base valve or the upper screw-off cap.

Mini immersion cylinder

Capacity ml	Dia. mm	Height mm	Item no.
50	32	180	5365-5000 N4

Target immersion cylinder



Precise liquid samples can be taken with the Target immersion cylinder.

- ▶ Weight 2.6 kg
- ▶ Incl. venting lowering cable (5 m), valve and cable reel
- ▶ Screw-off top enables easy cleaning

Use

1. Lower the immersion cylinder to the required depth on the high-tensile, closed hose.
2. When the target has been reached, open the air valve at the tube end.
3. This vents the immersion cylinder and fills it.
4. Retrieve the immersion cylinder.
5. Open the cover and pour out the sample.

Target immersion cylinder			
Capacity ml	Dia. mm	Height mm	Item no.
500	75	210	5365-6000 N4

AquaSampler



Sampler for ground water samples from wells, pits and other sources. Fits all normal well shafts with control openings to Ø 2", without tilting or getting stuck. Ultra pure materials guarantee the highest degree of sample purity. Easy to clean thanks to rounded edges and threads.

- ▶ FEP/PTFE ultra pure, anti adhesive surface

Please order the required lowering cable separately (page 112).

AquaSampler			
Capacity ml	Total length cm	Outer dia. mm	Item no.
350	40	46	5308-0350 N4
700	76	46	5308-0700 N4
1050	107	46	5308-1050 N4

Manually-operated reels



Manually-operated drum reel PP



Manually-operated drum reel PA electrically-conductive



Manually-operated reel Ex with grounding cable

The manually-operated drum reels are used to lower dipping bottles and immersion cylinders safely to the required depth in shafts, wells and tanks and then to pull them up again. The manually-operated drum reels can be equipped with various cables or chains. If flammable or highly flammable liquids are to be collected, then electrically conductive manually-operated drum reels must be used together with an earthing cable. The dipping bottles must be made of non-sparking metal.

- ▶ High winding capacity of up to 150 m for cable 2 mm dia.
- ▶ Reel width: inner 44 mm, outer 55 mm, reel diameter: inner 100 mm, outer 180 mm

! Please order the required lowering cable separately.



Manually-operated reel

Model	Item no.
① Manually-operated reel PP	5309-0010 N4
② Manually-operated reel PA	5309-0020 N4
③ Manually-operated reel Ex with grounding cable	5309-0030 N4

Lowering cables



Stainless steel lowering cable, PTFE-coated 316L



Lowering cable AISI 316L



Lowering cable plastic



Copper lowering cable EX with loops

Lowering cables

For dipping bottles and immersion cylinders, matching manually-operated drum reels made of various materials. Tensile load max. up to 10 kg.

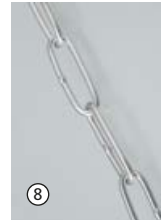

Lowering/hoisting chain stainless steel



Snap-hook AISI 316L



Brass shackle

Lowering cable

Model	Length m	Dia. mm	Item no.
④ Stainless steel lowering cable, PTFE-coated	10	2	5309-0110 N4
④ Stainless steel lowering cable, PTFE-coated	25	2	5309-0125 N4
④ Stainless steel lowering cable, PTFE-coated	50	2	5309-0150 N4
⑤ Stainless steel lowering cable	10	1.25	5309-0301 N4
⑤ Stainless steel lowering cable	25	1.25	5309-0302 N4
⑤ Stainless steel lowering cable	50	1.25	5309-0305 N4
⑥ Lowering cable made of PP cord	10	2	5309-0201 N4
⑥ Lowering cable made of PP cord	25	2	5309-0202 N4
⑥ Lowering cable made of PP cord	50	2	5309-0205 N4
⑦ Copper lowering cable EX with loops	10	4.5	5309-0410 N4
⑦ Copper lowering cable EX with loops	25	4.5	5309-0425 N4
⑦ Copper lowering cable EX with loops	50	4.5	5309-0450 N4
⑧ Stainless steel chains	10	2.3	5309-0510 N4
⑧ Stainless steel chains	25	2.3	5309-0525 N4
⑧ Stainless steel chains	100	2.3	5309-0550 N4
⑨ Snap hooks AISI 316L	5		0006-5300 N4
⑩ Brass shackle	4.5		0006-5301 N4

DispoSampler – disposable samplers | for the highest standards in sampling



Bürkle disposable samplers – DispoSampler – are used to take samples of liquids, viscous media, powders and granulates. Target point samples can be taken, all-layer and cross-section samples, as well as small and large sample quantities.

Unlike conventional reusable samplers, disposable samplers do not need to be cleaned after use.



- ▶ Cleaning reusable samplers is a demanding and often complicated task, with greasy, strongly adhesive or toxic substances. Sometimes the task is even impossible
- ▶ Work processes do not have to be interrupted by cleaning
- ▶ Cross contamination is completely eliminated
- ▶ The cleaning method does not need to be validated in audits
- ▶ Time and money are saved



Bürkle DispoSampler LaboPlast® and SteriPlast®



LaboPlast

SteriPlast



- ▶ Individually packaged
- ▶ Production, assembly and packaging in class 7 clean room (10,000)
- ▶ Complies with EU food requirements and FDA regulations
- ▶ Optionally sterilised by gamma rays

Time is money – Compare the costs:

- Bring to cleaning area
- Remove sampler
- Cleaning agent
- Work time
- Autoclaving in some cases
- Drying
- Mount sampler
- Packaging if required
- Transport and storage

Due to the effort involved in cleaning and the costs associated with it, it is often more economical to use a Bürkle disposable sampler.



LiquiDispo



The LiquiDispo disposable sampler can be used to take samples of liquids from highly liquid to slightly viscous. An ergonomic handle makes it easier to draw the sample: up to 200 ml can be drawn, as with a syringe.

- ▶ Ergonomic handle
- ▶ No seals
- ▶ HDPE
- ▶ Clean room manufactured, individually packaged
- ▶ Optionally sterilised by gamma rays
- ▶ Opening diameter 2.5 mm
- ▶ Ø 21 mm



LiquiDispo							
Length mm	Volume ml	Model	Pieces per pack	Item no.			
500	100	standard	20	5393-1120	N4		
500	100	sterilised	20	5393-1121	N4		
1000	200	standard	20	5393-1130	N4		
1000	200	sterilised	20	5393-1131	N4		

DispoPipette



Simple disposable sampler for taking samples of low viscosity media. If the DispoPipette is inserted into the liquid opened, an all-layer sample is obtained. If it is closed while it is inserted up to the sampling point and then opened, a target-point sample is obtained. Very easy to operate. With two opening sizes (2,5/5,5 mm) for different viscosities.

- ▶ All-layer and target point samples possible
- ▶ HDPE
- ▶ Clean room manufactured, individually packaged
- ▶ Optionally sterilised by gamma rays
- ▶ Ø 21 mm



DispoPipette							
Length mm	Volume ml	Model	Pieces per pack	Item no.			
500	100	standard	20	5393-5500	N4		
500	100	sterilised	20	5393-5501	N4		
1000	200	standard	20	5393-5531	N4		
1000	200	sterilised	20	5393-5532	N4		

DispoTube



The ergonomic handle of the DispoTube makes it easier to work and facilitates a good grip even under difficult conditions, for example with gloves. Disposable sampler for taking samples of liquids.

- ▶ Ergonomic handle
- ▶ All-layer and target point samples possible
- ▶ HDPE
- ▶ Clean room manufactured, individually packaged
- ▶ Optionally sterilised by gamma rays
- ▶ Opening diameter 5.5 mm
- ▶ Ø 21 mm



DispoTube							
Length mm	Volume ml	Model	Pieces per pack	Item no.			
500	100	standard	20	5393-6620	N4		
500	100	sterilised	20	5393-6621	N4		
1000	200	standard	20	5393-6630	N4		
1000	200	sterilised	20	5393-6631	N4		

DispoLadle



DispoLadle is a sampling scoop specially designed for disposable use. The scaled scoop with embossing can be used for measuring. It shows contents in increments of 10 ml, up to 200 ml. An ergonomic handle and a spout on both sides for right or left-hand operation make handling simple and easy.

- ▶ 200 ml scoop
- ▶ External Ø 92 mm
- ▶ Ergonomic handle
- ▶ HDPE
- ▶ Clean room manufactured, individually packaged
- ▶ Optionally sterilised by gamma rays



DispoLadle							
Length mm	Model	Pieces per pack	Item no.				
500	standard	20	5393-6640	N4			
500	sterilised	20	5393-6641	N4			
1000	standard	20	5393-6650	N4			
1000	sterilised	20	5393-6651	N4			

ViscoDispo



The ViscoDispo disposable sampler can be used to take samples of high-viscosity media up to 100.000 mPas. The ergonomically shaped handle and the very stable drawbar make it easy to draw even viscous substances.

- ▶ Ergonomic handle
- ▶ No seals
- ▶ HDPE
- ▶ Clean room manufactured, individually packaged
- ▶ Optionally sterilised by gamma rays
- ▶ Opening diameter 10 mm
- ▶ Ø 21 mm



ViscoDispo

Length mm	Volume ml	Model	Pieces per pack	Item no.			
500	100	standard	20	5393-3320	N4		
500	100	sterilised	20	5393-3321	N4		
1000	200	standard	20	5393-3330	N4		
1000	200	sterilised	20	5393-3331	N4		

PowderDispo



PowderDispo is the ideal disposable sampler for cross-section samples of powdery or slightly cohesive substances. A complete all-layer sample can be taken from bags or smaller containers with the lance.

- ▶ HDPE
- ▶ Clean room manufactured, individually packaged
- ▶ Optionally sterilised by gamma rays
- ▶ Ø 21 mm

PowderDispo

Length mm	Volume ml	Model	Pieces per pack	Item no.			
300	60	standard	20	5393-5510	N4		
300	60	sterilised	20	5393-5511	N4		
500	100	standard	20	5393-5522	N4		
500	100	sterilised	20	5393-5521	N4		

DispoPicker



Disposable sampler for powders and small-grain bulk materials. Because the tip is closed, the sample material cannot trickle back out of the sample lance. DispoPicker is ideally suited for cross-section samples.

- ▶ HDPE
- ▶ Clean room manufactured, individually packaged
- ▶ Optionally sterilised by gamma rays
- ▶ Ø 21 mm

DispoPicker						
Length mm	Volume ml	Model	Pieces per pack	Item no.		
300	60	standard	20	5393-5540	N4	
300	60	sterilised	20	5393-5541	N4	
500	100	standard	20	5393-5550	N4	
500	100	sterilised	20	5393-5551	N4	

DispoLance



The DispoLance disposable sampler can be used for taking large and small sample quantities quickly and easily, directly from bags. The sampler is suitable for free-flowing powders and small-grain granulates. The DispoLance sampler pierces into the container with the sturdy tip and the sample flows through the open inner tube directly into the container or bag that is held underneath.

- ▶ Variable sample quantity
- ▶ HDPE
- ▶ Clean room manufactured, individually packaged
- ▶ Optionally sterilised by gamma rays
- ▶ Nominal width 14 mm
- ▶ Ø 21 mm

DispoLance						
Length mm	Model	Pieces per pack	Item no.			
300	standard	20	5393-5560	N4		
300	sterilised	20	5393-5561	N4		
500	standard	20	5393-5570	N4		
500	sterilised	20	5393-5571	N4		

Accessories

Description
Sampling bag SteriBag see page 120

MicroDispo

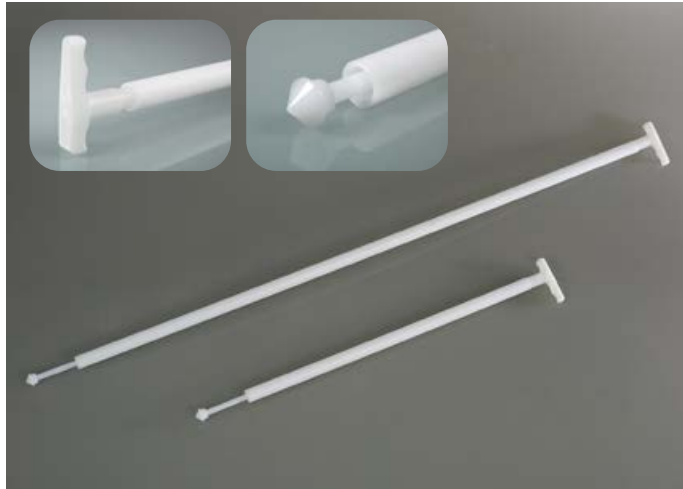

Quite small sample quantities (10 ml) can be taken with MicroDispo. Especially in pharmaceutical applications it often happens that only a small quantity can or should be extracted for analysis. Using the disposable sampler, precise target point samples can be taken of free-flowing powders and small-grain bulk materials.

- ▶ Ergonomic handle
- ▶ HDPE
- ▶ Clean room manufactured, individually packaged
- ▶ Optionally sterilised by gamma rays
- ▶ Ø 21 mm



MicroDispo

Length mm	Volume ml	Model	Pieces per pack	Item no.
500	10	standard	20	5393-2240 N4
500	10	sterilised	20	5393-2241 N4
1000	10	standard	20	5393-2250 N4
1000	10	sterilised	20	5393-2251 N4



MultiDispo



Disposable zone samplers for taking samples from multiple layers of the sample material. Suitable for free-flowing powders and small-grain granulates. The representative all-layer sample can be emptied directly through the open handle into a sample container.

- ▶ Easy emptying through the opening in the handle (Ø 14 mm)
- ▶ HDPE
- ▶ Clean room manufactured, individually packaged
- ▶ Optionally sterilised by gamma rays
- ▶ Ø 25 mm / Ø tip 30 mm



MultiDispo

Length mm	Volume ml	Model	Pieces per pack	Item no.
500	100	standard	20	5393-4440 N4
500	100	sterilised	20	5393-4441 N4
1000	200	standard	20	5393-4450 N4
1000	200	sterilised	20	5393-4451 N4



TargetDispo



TargetDispo is used to take a target point sample at a position in the sample material that has previously been precisely determined. The sampler pierces into the powder or granulate while closed. When it reaches the sample removal point it is opened and then closed again. In this way a precise target-point sample is obtained. The sample can simply be emptied through the open handle.

- ▶ Easy emptying through the opening in the handle (Ø 14 mm)
- ▶ HDPE
- ▶ Clean room manufactured, individually packaged
- ▶ Optionally sterilised by gamma rays
- ▶ Ø 25 mm / Ø tip 30 mm



TargetDispo						
Length mm	Volume ml	Model	Pieces per pack	Item no.		
500	100	standard	20	5393-4460 N4		
500	100	sterilised	20	5393-4461 N4		
1000	200	standard	20	5393-4470 N4		
1000	200	sterilised	20	5393-4471 N4		

ZoneDispo



The ZoneDispo disposable all-layer sampler is used in sampling to collect a representative all-layer sample from three different layers. Suitable for free-flowing powders and small-grain granulates. The collected sample can be secured and transported in the closed sampler.

- ▶ HDPE
- ▶ Clean room manufactured, individually packaged
- ▶ Optionally sterilised by gamma rays
- ▶ Ø 25 mm / Ø tip 30 mm



ZoneDispo						
Length mm	Volume ml	Model	Pieces per pack	Item no.		
500	100	standard	20	5393-4420 N4		
500	100	sterilised	20	5393-4421 N4		
1000	200	standard	20	5393-4430 N4		
1000	200	sterilised	20	5393-4431 N4		

Sampling bag SteriBag | the sterilised packaging bag

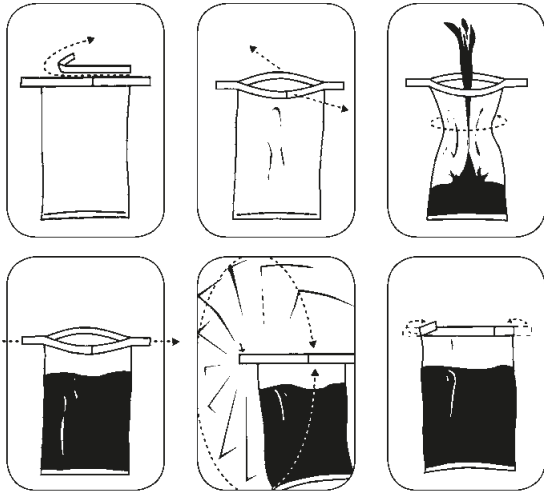

The sterile sampling bag SteriBag for samples in chemistry, pharmaceuticals, medicine, veterinary science and foodstuffs etc.

The bags are made of polyethylene and are therefore exceptionally tearproof and leakproof.

The SteriBag sampling bag is distinguished by its safe handling. When used according to instructions, samples are guaranteed sterile.

Integrated safety: The tab-ends are sealed in plastic film to prevent skin injuries.

- ▶ Sterile, RNase, DNase and pyrogen-free
- ▶ Can be labelled
- ▶ Leakproof
- ▶ Save space
- ▶ Transparent
- ▶ With practical closure to tear-open
- ▶ Proven millions of times

Bulk prices

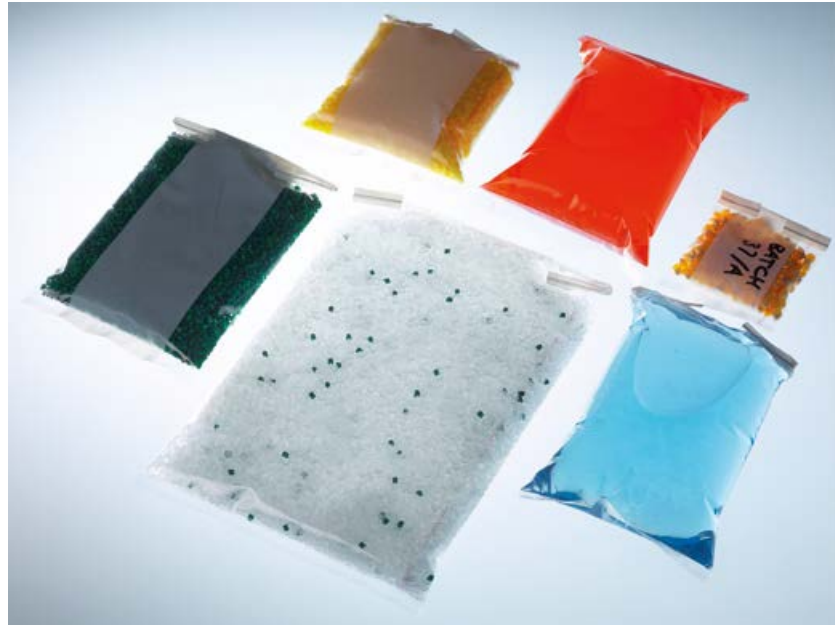

Sampling bag SteriBag



Capacity ml	Model	L x W mm	Pieces per pack	Item no.
60	without labelling area	127 x 76	500	5344-0060 N3
60	with labelling area	127 x 76	500	5344-0061 N3
150	without labelling area	178 x 76	500	5344-0180 N3
150	with labelling area	178 x 76	500	5344-0181 N3
450	without labelling area	229 x 114	500	5344-0540 N3
450	with labelling area	229 x 114	500	5344-0541 N3
650	without labelling area	229 x 140	500	5344-0720 N3
650	with labelling area	229 x 140	500	5344-0721 N3
800	without labelling area	305 x 114	500	5344-0810 N3
800	with labelling area	305 x 114	500	5344-0811 N3
1650	without labelling area	305 x 178	250	5344-1650 N3
1650	with labelling area	305 x 178	250	5344-1651 N3

SteriBag StandUp sample bag



SteriBag StandUp is a sterile sample bag with a stand-up base. The special bottom unfolds as soon as the bag is filled. This makes SteriBag StandUp stable and able to stand on its own without a separate stand or support, leaving both your hands free to take the sample and fill the bag. The wire bracket at the closure keeps the bag open, making it easy and convenient to fill.

The sample bag is the ideal space-saving, unbreakable, inexpensive and sterile replacement for bottles and beakers.

Can be used for samples available as liquids, powders, solids and pastes; suitable for foods and can be frozen.

The stable standing SteriBag StandUp sample bag is easy and safe to transport.

SteriBag StandUp, the sample bag for easy handling of samples.

- ▶ Stands stably
- ▶ Protected against discharge
- ▶ Sterile, RNase, DNase and pyrogen-free
- ▶ With labelling field

SteriBag StandUp sample bag						
Capacity ml	L x W mm	Pieces per pack	Item no.			
400	229 x 114	250	5344-0400 N3			
600	229 x 152	250	5344-0600 N3			

Sampling bag SteriBag Blue



The sterile sampling bag SteriBag Blue is especially well suited for use in the food, animal feed and pharmaceutical industries. To prevent the danger of foreign matter in production, the sample bags and the tear-off closure are coloured blue. This shade of blue does not occur in a natural form in foodstuffs. Because of this it is highly visible and can be reliably discovered in a visual check if a bag or parts of it are ever mixed into production.

The disposable sample bag is approved for contact with foods. It is suitable for storing and transporting solid, semi-solid and liquid media.

Thanks to the large opening, the SteriBag Blue can be filled easily. The sample bag with labelling field is space-saving, easy to transport and leak-proof.

- ▶ PE, blue
- ▶ Liquid-tight
- ▶ With labelling field
- ▶ Sterile, RNase, DNase and pyrogen-free

Sampling bag SteriBag Blue					
Capacity ml	L x W mm	Pieces per pack	Item no.		
650	229 x 140	500	5344-7008 N3		
1650	305 x 178	250	5344-7012 N3		

Sampling bag SteriBag Cleanroom



The sampling bag SteriBag Cleanroom with double packaging can be placed directly in the clean room. 25 sample bags are placed in double secondary packaging. They can be removed one after the other and are therefore ideally suited for introducing into the clean room. Then the sterile bags can be used directly in the clean room. SteriBag Cleanroom is sterile inside and outside. This guarantees contamination-free storage and transport of solid, semi-solid and liquid media. The sample bag is perfect for use in chemical and pharmaceutical applications.

The disposable sample bag has a labelling field, saves space and is also easy to transport. The large bag opening makes it easy to pour in the sample.

- ▶ Sterile, with double packaging
- ▶ RNase, DNase and pyrogen-free
- ▶ PE, transparent
- ▶ Liquid-tight
- ▶ With labelling field

Sampling bag SteriBag Cleanroom			
Capacity ml	L x W mm	Pieces per pack	Item no.
800	305 x 114	500	5344-8010 N3
1650	305 x 178	250	5344-8012 N3

SteriBag Premium sample bag



The SteriBag Premium sample bags uniquely combine a high degree of security, sterility, tamper evident closure and traceability, they are used to securely transport and for the storage of samples.

After sampling, the sample can be filled directly into the sterile sample bag. The tamper-evident closure seals the bag liquid-tight and secure. When trying to open the closure again, the word "STOP" appears clearly visible. Both the sample bag and the tear-off field are labeled with a unique tracking number, this allows a complete documentation and traceability.

SteriBag Premium is suitable for many demanding applications in the food, pharmaceutical, medical area as well as in cleanroom or biotechnology sectors.

- ▶ Sterilised by gamma rays (SAL 10⁻⁶)
- ▶ With integrated tamper-proof closure for manipulation evidence
- ▶ Unique identification via tracking number
- ▶ Suitable for the use with foodstuffs

SteriBag Premium tamper-proof sample bag			
Capacity ml	L x W mm	Pieces per pack	Item no.
300	200x145	100	5344-8000 N4

SteriPlast® Kit – sterile sampling set



The sampling set SteriPlast® Kit consists of ten sample spatulas or ten sample scoops and ten SteriBag Premium tamper-proof sample bags. Thus the SteriPlast® Kit is the ideal combination for sampling where purity and sterility is essential. All parts are sterilised by gamma rays and suitable for use with foodstuffs. The scoops or spatulas are clean room manufactured and individually packed. The sample bag SteriBag Premium has an integrated sealing and is liquid-tight. A unique tracking code on both the bag and the tear-off field guarantees complete documentation and traceability. SteriPlast® Kit including scoop 50 ml or spatula 150 mm insertion depth, and SteriBag Premium 300 ml.

- ▶ Scoop 50 ml & bag SteriBag Premium 300 ml
- ▶ Spatula 150 mm insertion depth & bag SteriBag Premium 300 ml

SteriPlast® Kit – sterile sampling set			
Model	Pieces per pack	Item no.	
Scoop & bag	10	5378-8003	N4
Spatula & bag	10	5378-8009	N4

SteriPlast® syringe



The syringe is used to take sterile samples and store them. The sample amount can be read off from the printed contents graduation. The syringe is supplied in a sterile package and is ready for immediate use. The syringe can be extended to any length with additional tubing. A Luer adapter is supplied for the 100 ml syringe.

- ▶ PP, transparent
- ▶ Contents graduation
- ▶ Sterilised, packed separately

Bulk prices

SteriPlast® syringe			
Capacity ml	Pieces per pack	Division ml	Item no.
50	10	1	5325-0060 N4
100	10	2	5325-0100 N4

SteriPlast® and LaboPlast®

b SteriPlast



Bürkle **SteriPlast®** products are high-quality, ergonomically shaped disposable products that are specially designed and optimised for sampling purposes. They are produced, assembled and individually packed in Bürkle's own clean room and then sterilised by rays.

The SteriPlast® products thus meet all the requirements for absolutely sterile sampling with first class certification.

b LaboPlast

LaboPlast® is the Bürkle brand for high-quality plastic products that have been specially designed and developed to optimally meet the demanding and in part special requirements in laboratories, industry and science.

Here LaboPlast® stands for the best quality, excellent craftsmanship and outstanding material properties.

Test the products and get to know and appreciate our LaboPlast® product lines!

LaboPlast® scoop, disposable



The LaboPlast® disposable scoop made of polystyrene is produced and assembled in our clean room of class 7 (10,000) and individually packaged for disposable use. The disposable scoop is ideal for powders, granulates and pastes. The scoop with transparent cover can be closed immediately after sampling and the exclusion of contamination can therefore be safeguarded.

- ▶ PS, white
- ▶ Individually packaged
- ▶ Production, assembly and packaging according to clean room class 7
- ▶ Complies with EU food requirements and FDA regulations



LaboPlast® scoop, disposable

Capacity ml	Model	Length mm	Pieces per pack	Item no.
25	without cover	141	10	5378-0001 N4
25	with cover	142	10	5378-0002 N4
50	without cover	160	10	5378-0003 N4
50	with cover	161	10	5378-0004 N4
100	without cover	205	10	5378-0005 N4
100	with cover	206	10	5378-0006 N4
150	without cover	216	10	5378-0007 N4
150	with cover	218	10	5378-0008 N4
250	without cover	232	10	5378-0013 N4
250	with cover	235	10	5378-0014 N4
500	without cover	280	10	5378-0015 N4
500	with cover	283	10	5378-0016 N4
1000	without cover	332	10	5378-0019 N4
2000	without cover	381	10	5378-0020 N4

SteriPlast® sample scoop

The SteriPlast® sample scoop made of polystyrene is produced and assembled in our clean room of class 7 (10,000), individually packaged for disposable use and then sterilised by gamma rays. The sample scoop is ideal for powders, granulates and pastes.

The scoop with transparent cover can be closed immediately after sampling and the sterility and exclusion of contamination can therefore be safeguarded.

- ▶ PS, white
- ▶ Individually packaged and sterilised by gamma rays
- ▶ Production, assembly and packaging according to clean room class 7
- ▶ Complies with EU food requirements and FDA regulations



Ergonomics were particularly important to us for the design of the sample scoop. The scoop stands horizontally due to the special handle design and the slightly angled front edge and can therefore be put down without the sample material trickling out.

SteriPlast® sample scoop

Capacity ml	Model	Length mm	Pieces per pack	Item no.	
25	without cover	141	10	5378-1001	N4
25	with cover	142	10	5378-1002	N4
50	without cover	160	10	5378-1003	N4
50	with cover	161	10	5378-1004	N4
100	without cover	205	10	5378-1005	N4
100	with cover	206	10	5378-1006	N4
150	without cover	216	10	5378-1007	N4
150	with cover	218	10	5378-1008	N4
250	without cover	232	10	5378-1013	N4
250	with cover	235	10	5378-1014	N4
500	without cover	280	10	5378-1015	N4
500	with cover	283	10	5378-1016	N4
1000	without cover	332	10	5378-1019	N4
2000	without cover	381	10	5378-1020	N4



Sampling scoop, long handle, disposable



The sampling scoop can be used to take samples of powders, granulates and pastes. The long handle makes it possible to sample larger containers even with little content or to reach through narrow openings.

With the straight bottom of the scoop, the medium can be scooped up directly from the bottom of the container.

The disposable scoop is suitable for sensitive areas of pharmaceuticals and chemistry as well as the food and cosmetics industries.

- ▶ PS, white
- ▶ Individually packaged and optionally sterilised
- ▶ Handle length 300 mm
- ▶ For single use
- ▶ Clean room manufactured (clean room class 7)
- ▶ Complies with EU food requirements and FDA regulations



Sampling scoop, long handle, disposable

Total length mm	Capacity ml	Model	Pieces per pack	Item no.
390	50	standard	10	5378-5013 N4
390	50	sterilised	10	5378-5014 N4
415	100	standard	10	5378-5017 N4
415	100	sterilised	10	5378-5018 N4

Ladle, long handle, disposable



The ladle is suitable for taking samples of liquids and viscous media as well as powders and granulates. The ladle has a very smooth bottom and rounded corners. This makes it possible to reach into any corner of a container or to take medium directly from the bottom of the container. A long handle with indentations for fingers ensures a firm hold and precise work. The disposable ladle can be used in the pharmaceutical industry, chemistry and cosmetics and the food and animal feed industries.

- ▶ PS, white
- ▶ Individually packaged and optionally sterilised
- ▶ Reaches into any corner
- ▶ Handle length 300 mm
- ▶ For single use
- ▶ Clean room manufactured (clean room class 7)
- ▶ Complies with EU food requirements and FDA regulations



Ladle, long handle, disposable

Total length mm	Capacity ml	Model	Pieces per pack	Item no.
365	30	standard	10	5378-5021 N4
365	30	sterilised	10	5378-5022 N4

Sample spatula white, disposable



The disposable spatula made of polystyrene is produced and assembled in our clean room of class 7 (10,000) and individually packaged for disposable use.

As a result of the long, ergonomically-shaped, stable handle and a sharp blade, it is possible to even penetrate directly into containers such as paper or plastic sacks. The disposable spatula is ideal for sampling powders, granulates and pastes.

The spatula with transparent sealing sleeve can be closed again immediately after sampling and the exclusion of contamination can be safeguarded for the sample taken.

- ▶ PS, white
- ▶ Production, assembly and packaging according to clean room class 7
- ▶ Complies with EU food requirements and FDA regulations

LaboPlast® spatula, disposable

- ▶ Individually packaged

SteriPlast® sample spatula

- ▶ Individually packaged and sterilised by gamma rays



LaboPlast® spatula, disposable

Model	Total length mm	Insertion depth mm	Pieces per pack	Item no.		
without sleeve	263	150	10	5378-0009	N4	
with sleeve	268	150	10	5378-0010	N4	

SteriPlast® sample spatula

Model	Total length mm	Insertion depth mm	Pieces per pack	Item no.			
without sleeve	263	150	10	5378-1009	N4		
with sleeve	268	150	10	5378-1010	N4		

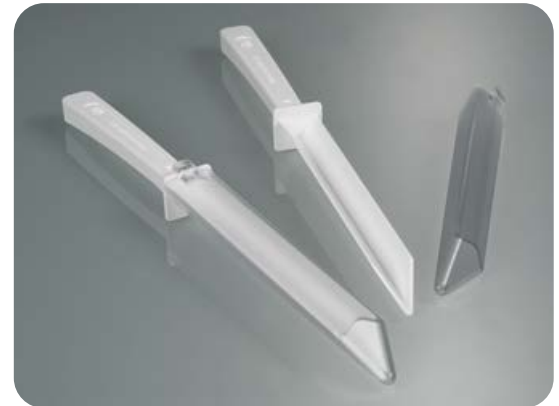

Sample spoon white, disposable



The disposable spoon made of polystyrene is produced in our clean room of class 7 (10,000) and individually packaged for disposable use.

The spoon is available in two sizes, 2.5 ml (similar to a teaspoon) and 10 ml (similar to a tablespoon), and is ideal for sampling powders, granulates and fluids.

- ▶ PS, white
- ▶ Production and packaging according to clean room class 7
- ▶ Complies with EU food requirements and FDA regulations

LaboPlast® spoon, disposable

- ▶ Individually packaged

SteriPlast® sample spoon

- ▶ Individually packaged and sterilised by gamma rays

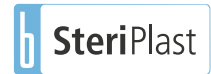

LaboPlast® spoon, disposable

Length mm	Capacity ml	Pieces per pack	Item no.
127	2.5	100	5378-0011 N4
170	10	100	5378-0012 N4



SteriPlast® sample spoon

Length mm	Capacity ml	Pieces per pack	Item no.
127	2.5	100	5378-1011 N4
170	10	100	5378-1012 N4



Sampling spoon, long handle, disposable



The sampling spoon with long handle can be used to remove powders, granulates, pastes or liquids. The long handle makes it easy to reach the bottoms of larger containers as well and allows for sampling of drums, jerrycans and bottles with small opening diameters. Thanks to the indentations on the handle, the disposable spoon rests comfortably and securely in the hand. The laboratory spoon is suitable for single use in the sensitive areas of pharmaceuticals, chemistry, cosmetics, animal feed and food & beverage.

- ▶ PS, white
- ▶ Individually packaged and optionally sterilised
- ▶ Handle length 300 mm
- ▶ For single use
- ▶ Clean room manufactured (clean room class 7)
- ▶ Complies with EU food requirements and FDA regulations



Sampling spoon, long handle, disposable

Total length mm	Capacity ml	Model	Pieces per pack	Item no.
355	5	standard	10	5378-5001 N4
355	5	sterilised	10	5378-5002 N4
375	20	standard	10	5378-5005 N4
375	20	sterilised	10	5378-5006 N4

Sampling spoon curved, long handle



The spoon with curved spoon bowl is suitable for a wide range of different media including powders, granulates, pastes and liquids. The angled spoon shape is also good for reaching into the corners of a container. The long handle of the plastic spoon makes it possible to empty residue from large containers easily and can also reach into places that are hard to reach such as jerrycans with narrow necks. The sampling spoon can be used in pharmaceutical applications, in the chemical industry and for food and cosmetics.

- ▶ PS, white
- ▶ Individually packaged and optionally sterilised
- ▶ With curved spoon shape
- ▶ Handle length 300 mm
- ▶ For single use
- ▶ Clean room manufactured (clean room class 7)
- ▶ Complies with EU food requirements and FDA regulations



Sampling spoon curved, long handle, disposable

Total length mm	Capacity ml	Model	Pieces per pack	Item no.
360	10	standard	10	5378-5009 N4
360	10	sterilised	10	5378-5010 N4

Dosing spoon, white



Volumetric and dosing spoons can be used to measure small amounts of powder, granulates and liquids exactly and dose them precisely. For precise measuring, excess medium is stripped off the upper edge of the spoon.

- ▶ PS, white
- ▶ Optionally packaged individually and sterilised



Dosing spoon, white

Capacity ml	Model	Pieces per pack	Item no.	  
0,5	large package	100	5378-4004	N4
0,5	sterilised, packaged individually	100	5378-4005	N4
1	large package	100	5378-4006	N4
1	sterilised, packaged individually	100	5378-4007	N4
2,5	large package	100	5378-4008	N4
2,5	sterilised, packaged individually	100	5378-4009	N4
5	large package	100	5378-4010	N4
5	sterilised, packaged individually	100	5378-4011	N4
10	large package	100	5378-4012	N4
10	sterilised, packaged individually	100	5378-4013	N4
15	large package	100	5378-4014	N4
15	sterilised, packaged individually	100	5378-4015	N4
25	large package	100	5378-4016	N4
25	sterilised, packaged individually	100	5378-4017	N4
50	large package	100	5378-4018	N4
50	sterilised, packaged individually	100	5378-4019	N4

Forceps, disposable



The disposable forceps are suitable for precise lab work and are ideal for grasping, lifting and moving small objects, for example fine tissue, small items or solid samples. The fluted handles ensure optimum and secure handling as well as precise work.

Available either in a large package with 100 pieces or 100 pieces packaged individually and radiation sterilised.

- ▶ For single use
- ▶ Clean room manufactured (clean room class 7)
- ▶ Complies with EU food requirements and FDA regulations
- ▶ Overall length 130 mm
- ▶ PS, white
- ▶ Optionally packaged individually and sterilised



Forceps, disposable

Shape	Model	Pieces per pack	Item no.	  
pointed/angled	sterilised, packaged individually	100	5378-1040	N4
pointed/angled	large package	100	5378-0040	N4
pointed	sterilised, packaged individually	100	5378-1041	N4
pointed	large package	100	5378-0041	N4
broad tip	sterilised, packaged individually	100	5378-1042	N4
broad tip	large package	100	5378-0042	N4

Scraper, white



The scraper, made of polystyrene, is produced in our class 7 clean room (10,000) and individually packaged for disposable use. Sturdy and convenient scraper for disposable use. The scraper is suitable for scraping off, smoothing or cleaning as well as removing residue.

Scraper LaboPlast®, disposable

- ▶ Individually packaged

Scraper SteriPlast®

- ▶ Individually packaged and sterilised by gamma rays

Scraper LaboPlast®, disposable

L x W mm	Pieces per pack	Item no.
200 x 80	10	5378-0030 N4

Scraper SteriPlast®

L x W mm	Pieces per pack	Item no.
200 x 80	10	5378-1030 N4

Sampling palette knife spatula white



The sampling palette knife spatula can be used to apply, distribute or evenly spread viscous media such as pastes and creams. The palette knife spatula reaches easily into the corners and curves of various containers and is suitable for scraping out bowls, removing residue or wiping off Bürkle's volumetric and dosing spoons. The dimensionally stable long edge of the plastic scraper is ideal for cutting viscous media. A small tip on the long edge can be used for ripping, for example packaging film. The scraper is also suitable for stirring and blending. The disposable sampling palette knife spatula is suitable for use in the pharmaceutical industry, chemistry, cosmetics and food & beverage.

- ▶ PS, white
- ▶ Optionally packaged individually and sterilised
- ▶ L x W 192 x 20 mm
- ▶ For single use
- ▶ Clean room manufactured (clean room class 7)
- ▶ Complies with EU food requirements and FDA regulations

Sampling palette knife spatula white, disposable

Model	Pieces per pack	Item no.
Large package	100	5378-0035 N4
sterilised, packaged individually	100	5378-1035 N4

Disposable funnel for liquids



Disposable funnel for reliable filling of liquids, ideal for filling bottles and other containers with a narrow filler opening. The disposable funnel ensures no loss when transferring liquid samples or free-flowing solids. That makes this practical and hygienic pouring aid a helpful accessory for sampling or in laboratories.

Disposable funnel for liquids

- ▶ PS, white
- ▶ Clean room manufactured (clean room class 7)
- ▶ Individually packaged



Disposable funnel for liquids, sterile

- ▶ PS, white
- ▶ Clean room manufactured (clean room class 7)
- ▶ Individually packaged and sterilised

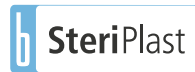

Disposable funnel for liquids			
Outer dia. mm	Outlet dia. mm	Pieces per pack	Item no.
100	10	10	5378-6001 N4

Disposable funnel for liquids, sterile			
Outer dia. mm	Outlet dia. mm	Pieces per pack	Item no.
100	10	10	5378-6002 N4

Disposable powder funnel



The disposable powder funnel has a short, wide discharge and is suitable for transferring powdered samples and materials, granulates and suspensions as well as other liquids. The wide opening of the disposable powder funnel prevents the powder or granulates from clogging while dispensing. That makes this practical and hygienic pouring aid a helpful accessory for sampling or in laboratories.

Disposable powder funnel

- ▶ PS, white
- ▶ Clean room manufactured (clean room class 7)
- ▶ Individually packaged



Disposable powder funnel, sterile

- ▶ PS, white
- ▶ Clean room manufactured (clean room class 7)
- ▶ Individually packaged and sterilised

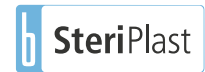

Disposable powder funnel			
Outer dia. mm	Outlet dia. mm	Pieces per pack	Item no.
100	25	10	5378-6005 N4

Disposable powder funnel, sterile			
Outer dia. mm	Outlet dia. mm	Pieces per pack	Item no.
100	25	10	5378-6006 N4

The purity of disposable products and ecological sustainability combined perfectly!



With our **LaboPlast® Bio** and **SteriPlast® Bio** product lines, we offer you products that feature all the properties for high-quality sampling. The improved specifications in this area can in part only be realised with disposable products. However to take into account environmental awareness and to safeguard ecologically sustainable trade, we now also offer these disposable products made of bio-plastic. **LaboPlast®** bio-products are only manufactured from renewable raw materials. **SteriPlast®** bio-products are also sterilised by gamma rays.



Green PE



Environmentally friendly & sustainable

- ▶ Product made of bio-plastic
- ▶ Made of sustainable raw materials, dispensing with fossil materials
- ▶ CO₂ saving and thus reduction of the greenhouse effect
- ▶ 100 % recyclable

Bio sample scoop



The Bio sample scoop made of green PE is produced in our clean room of class 7 (10,000) and individually packaged for disposable use.

Green PE bio-plastic has all the suitable properties of conventional polyethylene but is manufactured from renewable raw materials and can be completely recycled.

The sample scoop is ideal for powders, granulates and pastes.

- ▶ Product made of renewable raw materials
- ▶ Bio-PE, white
- ▶ Production and packaging according to clean room class 7
- ▶ Complies with EU food requirements and FDA regulations

LaboPlast® Bio scoop

- ▶ Individually packaged

SteriPlast® Bio sample scoop

- ▶ Individually packaged and sterilised by gamma rays



LaboPlast® Bio scoop

Capacity ml	Length mm	Pieces per pack	Item no.
25	141	10	5379-0001 N4
50	160	10	5379-0003 N4
100	205	10	5379-0005 N4
150	216	10	5379-0007 N4

SteriPlast® Bio sample scoop

Capacity ml	Length mm	Pieces per pack	Item no.
25	141	10	5379-1001 N4
50	160	10	5379-1003 N4
100	205	10	5379-1005 N4
150	216	10	5379-1007 N4

Sampling scoop, long handle, disposable



The sampling scoop can be used to take samples of powders, granulates and pastes. The long handle makes it possible to sample larger containers even with little content or to reach through narrow openings. With the straight bottom of the scoop, the medium can be scooped up directly from the bottom of the container. The disposable scoop is suitable for sensitive areas of pharmaceuticals and chemistry as well as the food and cosmetics industries.

- ▶ Product made from renewable raw materials
- ▶ Bio-PE, white
- ▶ Individually packaged and optionally sterilised
- ▶ Handle length 300 mm
- ▶ For single use
- ▶ Clean room manufactured (clean room class 7)
- ▶ Complies with EU food requirements and FDA regulations



Sampling scoop, long handle, disposable Bio



Total length mm	Capacity ml	Model	Pieces per pack	Item no.
390	50	standard	10	5379-0024 N4
390	50	sterilised	10	5379-1024 N4
415	100	standard	10	5379-0025 N4
415	100	sterilised	10	5379-1025 N4

Bio sample spatula

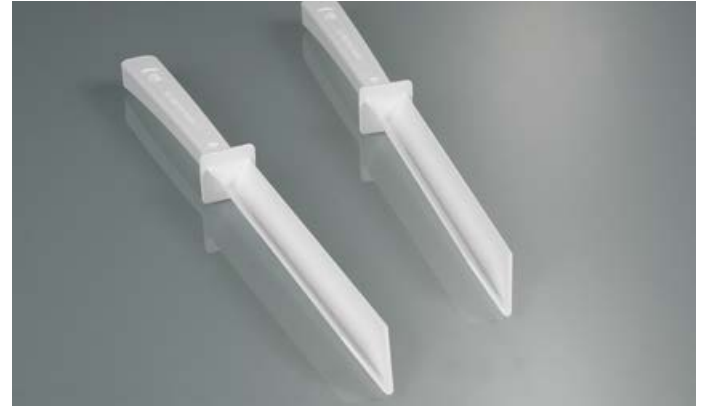

The disposable spatula made of green PE is produced in our clean room of class 7 (10,000) and individually packaged for disposable use. Green PE bio-plastic has all the suitable properties of conventional polyethylene and can be completely recycled but is manufactured from renewable raw materials. As a result of the long, ergonomically-shaped, stable handle and a sharp blade, it is possible to even penetrate directly into containers such as paper or plastic sacks. The spatula is ideal for sampling powders, granulates and pastes.

LaboPlast® Bio spatula

- ▶ Individually packaged

SteriPlast® Bio sample spatula

- ▶ Individually packaged and sterilised by gamma rays



LaboPlast® Bio spatula



Total length mm	Insertion depth mm	Pieces per pack	Item no.
263	150	10	5379-0009 N4

SteriPlast® Bio sample spatula



Total length mm	Insertion depth mm	Pieces per pack	Item no.
263	150	10	5379-1009 N4

Bio sample spoons



The disposable spoon made of green PE is produced in our clean room of class 7 (10,000) and individually packaged for disposable use. Green PE bio-plastic has all the suitable properties of conventional polyethylene but is manufactured from renewable raw materials and can be completely recycled. The disposable spoon is available in two sizes, 2.5 ml (similar to a teaspoon) and 10 ml (similar to a table-spoon), and is ideal for sampling powders, granulates and fluids.

LaboPlast® Bio spoon

- ▶ Individually packaged

SteriPlast® Bio sample spoon

- ▶ Individually packaged and sterilised by gamma rays

LaboPlast® Bio spoon						
Length mm	Capacity ml	Pieces per pack	Item no.			
127	2.5	100	5379-0011	N4		
170	10	100	5379-0012	N4		

SteriPlast® Bio sample spoon							
Length mm	Capacity ml	Pieces per pack	Item no.				
127	2.5	100	5379-1011	N4			
170	10	100	5379-1012	N4			

Sampling spoon, long handle, disposable



Sampling spoon, long handle, disposable Bio

The long handle makes it easy to reach the bottoms of larger containers as well and allows for sampling of drums, jerrycans and bottles with small opening diameters.

Sampling spoon curved, long handle, disposable Bio

The long handle of the plastic spoon makes it possible to empty residue from large containers easily and can also reach into places that are hard to reach such as jerrycans with narrow necks.

- ▶ Product made from renewable raw materials
- ▶ Bio-PE, white
- ▶ Individually packaged and optionally sterilised

Sampling spoon, long handle, disposable Bio								
Total length mm	Capacity ml	Model	Pieces per pack	Item no.				
355	5	standard	10	5379-0021	N4			
355	5	sterilised	10	5379-1021	N4			
375	20	standard	10	5379-0022	N4			
375	20	sterilised	10	5379-1022	N4			

Sampling spoon curved, long handle, disposable Bio								
Total length mm	Capacity ml	Model	Pieces per pack	Item no.				
360	10	standard	10	5379-0023	N4			
360	10	sterilised	10	5379-1023	N4			

Ladle, long handle, disposable Bio



- ▶ Product made from renewable raw materials
- ▶ Bio-PE, white
- ▶ Individually packaged and optionally sterilised

The ladle is suitable for taking samples of liquids and viscous media as well as powders and granulates. The ladle has a very smooth bottom and rounded corners. This makes it possible to reach into any corner of a container or to take medium directly from the bottom of the container. A long handle with indentations for fingers ensures a firm hold and precise work. The disposable ladle can be used in the pharmaceutical industry, chemistry and cosmetics and the food and animal feed industries.

Ladle, long handle, disposable Bio

Total length mm	Capacity ml	Model	Pieces per pack	Item no.	
365	30	standard	10	5379-0026	N4
365	30	sterilised	10	5379-1026	N4

Sampling palette knife spatula, disposable



The sampling palette knife spatula can be used to apply, distribute or evenly spread viscous media such as pastes and creams. The palette knife spatula reaches easily into the corners and curves of various containers and is suitable for scraping out bowls, removing residue or wiping off Bürkle's volumetric and dosing spoons. The dimensionally stable long edge of the plastic scraper is ideal for cutting viscous media. A small tip on the long edge can be used for ripping, for example packaging film. The scraper is also suitable for stirring and blending. The disposable sampling palette knife spatula is suitable for use in the pharmaceutical industry, chemistry, cosmetics and food & beverage.

- ▶ Product made from renewable raw materials
- ▶ Bio PE, white, flexible and break-proof
- ▶ Optionally packaged individually and sterilised

Sampling palette knife spatula, disposable Bio

Model	Pieces per pack	Item no.
Large package	100	5379-0035 N4
sterilised, packaged individually	100	5379-1035 N4

Disposable funnel for liquids Bio



Disposable funnel for reliable filling of liquids, ideal for filling bottles and other containers with a narrow filler opening. The disposable funnel ensures no loss when transferring liquid samples or free-flowing solids. That makes this practical and hygienic pouring aid a helpful accessory for sampling or in laboratories.

Disposable funnel for liquids Bio

- ▶ Bio-PE, white
- ▶ Product made from renewable raw materials
- ▶ Clean room manufactured (clean room class 7)
- ▶ Individually packaged

Disposable funnel for liquids Bio, sterile

- ▶ Bio-PE, white
- ▶ Product made from renewable raw materials
- ▶ Clean room manufactured (clean room class 7)
- ▶ Individually packaged and sterilised



Disposable funnel for liquids Bio			
Outer dia. mm	Outlet dia. mm	Pieces per pack	Item no.
100	10	10	5379-0040 N4

Disposable funnel for liquids Bio, sterile			
Outer dia. mm	Outlet dia. mm	Pieces per pack	Item no.
100	10	10	5379-1040 N4

Disposable powder funnel Bio



The disposable powder funnel has a short, wide discharge and is suitable for transferring powdered samples and materials, granulates and suspensions as well as other liquids. The wide opening of the disposable powder funnel prevents the powder or granulates from clogging while dispensing. That makes this practical and hygienic pouring aid a helpful accessory for sampling or in laboratories.

Disposable powder funnel Bio

- ▶ Bio-PE, white
- ▶ Product made from renewable raw materials
- ▶ Clean room manufactured (clean room class 7)
- ▶ Individually packaged

Disposable powder funnel Bio, sterile

- ▶ Bio-PE, white
- ▶ Product made from renewable raw materials
- ▶ Clean room manufactured (clean room class 7)
- ▶ Individually packaged and sterilised



Disposable powder funnel Bio			
Outer dia. mm	Outlet dia. mm	Pieces per pack	Item no.
100	25	10	5379-0041 N4

Disposable powder funnel Bio, sterile			
Outer dia. mm	Outlet dia. mm	Pieces per pack	Item no.
100	25	10	5379-1041 N4

Disposable sampler, blue



The shade of blue that is used does not occur in a natural form in foodstuffs. Because of this, blue products or parts of them can be quickly found and easily identified in a visual check if they are ever mixed into production.

The use of blue tools thus helps to meet the requirements of the HACCP hazard analysis and assessment in reference to foreign objects. This is an important criterion, especially in food processing and production and in the animal feed and pharmaceutical industry.

- ▶ Can be used as part of HACCP/IFS/BRC foreign object management
- ▶ Especially for the food, animal feed and pharmaceutical industries
- ▶ PS, blue
- ▶ Individually packaged and sterilised by gamma rays
- ▶ Production, assembly and packaging according to clean room class 7
- ▶ Complies with EU food requirements and FDA regulations

Food scoop, blue



The SteriPlast® food scoop, made of blue polystyrene, is produced in our class 7 clean room (10,000), individually packaged for disposable use and then sterilised by gamma rays.

The food scoop is ideal for powders, granulates and pastes.



Food scoop, blue

Capacity ml	Length mm	Pieces per pack	Item no.
25	141	10	5378-3001 N4
50	160	10	5378-3003 N4
100	205	10	5378-3005 N4
150	216	10	5378-3007 N4
250	232	10	5378-3013 N4
500	280	10	5378-3015 N4
1000	332	10	5378-3019 N4
2000	381	10	5378-3020 N4



Food scoop, long handle, blue



The sampling scoop can be used to take samples of powders, granulates and pastes. The long handle makes it possible to sample larger containers even with little content or to reach through narrow openings.

With the straight bottom of the scoop, the medium can be scooped up directly from the bottom of the container.

The disposable scoop is suitable for sensitive areas of pharmaceuticals and chemistry as well as the food and cosmetics industries.

- ▶ PS, blue
- ▶ Individually packaged and sterilised
- ▶ Handle length 300 mm
- ▶ For single use
- ▶ Clean room manufactured (clean room class 7)
- ▶ Complies with EU food requirements and FDA regulations

Food scoop, long handle, blue

Total length mm	Capacity ml	Pieces per pack	Item no.
390	50	10	5378-5015 N4
415	100	10	5378-5019 N4

Spatula for foodstuffs, blue

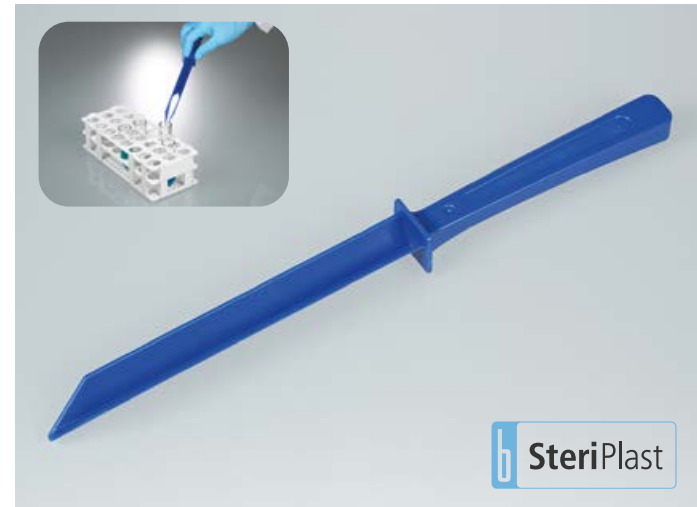

The SteriPlast® spatula for foodstuffs, made of polystyrene, is produced in our class 7 clean room (10,000), individually packaged for disposable use and then sterilised by gamma rays.

As a result of the long, ergonomically-shaped, stable handle and a sharp blade, it is possible to even penetrate directly into containers such as paper or plastic sacks. The spatula for foodstuffs is ideal for sampling powders, granulates and pastes.

- ▶ PS, blue
- ▶ Individually packaged and sterilised by gamma rays
- ▶ Production, assembly and packaging according to clean room class 7
- ▶ Complies with EU food requirements and FDA regulations



Spatula for foodstuffs, blue

Total length mm	Insertion depth mm	Pieces per pack	Item no.
263	150	10	5378-3009 N4

Spoon for foodstuffs, blue



The SteriPlast® spoon for foodstuffs, made of polystyrene, is produced in our class 7 clean room (10,000), individually packaged for disposable use and then sterilised by gamma rays. The spoon for foodstuffs is available in two sizes, 2.5 ml (similar to a teaspoon) and 10 ml (similar to a tablespoon), and is ideal for sampling powders, granulates, pastes and fluids.



- ▶ PS, blue
- ▶ Individually packaged and sterilised by gamma rays
- ▶ Production, assembly and packaging according to clean room class 7
- ▶ Complies with EU food requirements and FDA regulations

Spoon for foodstuffs, blue

Length mm	Capacity ml	Pieces per pack	Item no.
127	2.5	100	5378-3011 N4
170	10	100	5378-3012 N4

Food spoons, long handle, blue



Food spoons, long handle, blue

The long handle makes it easy to reach the bottoms of larger containers as well and allows for sampling of drums, jerrycans and bottles with small opening diameters.

Sampling spoon curved, long handle, blue

The long handle of the plastic spoon makes it possible to empty residue from large containers easily and can also reach into places that are hard to reach such as jerrycans with narrow necks.

- ▶ Handle length 300 mm
- ▶ For single use
- ▶ Clean room manufactured (clean room class 7)
- ▶ Complies with EU food requirements and FDA regulations
- ▶ PS, blue
- ▶ Individually packaged and sterilised

Food spoons, long handle, blue

Total length mm	Capacity ml	Pieces per pack	Item no.
355	5	10	5378-5003 N4
375	20	10	5378-5007 N4

Sampling spoon curved, long handle, blue

Total length mm	Capacity ml	Pieces per pack	Item no.
360	10	10	5378-5011 N4

Ladle, long handle, disposable, blue



The ladle is suitable for taking samples of liquids and viscous media as well as powders and granulates. The ladle has a very smooth bottom and rounded corners. This makes it possible to reach into any corner of a container or to take medium directly from the bottom of the container. A long handle with indentations for fingers ensures a firm hold and precise work. The disposable ladle can be used in the pharmaceutical industry, chemistry and cosmetics and the food and animal feed industries.

- ▶ PS, blue
- ▶ Individually packaged and sterilised
- ▶ Reaches into any corner
- ▶ Handle length 300 mm
- ▶ For single use
- ▶ Clean room manufactured (clean room class 7)
- ▶ Complies with EU food requirements and FDA regulations

Ladle, long handle, disposable, blue

Total length mm	Capacity ml	Pieces per pack	Item no.
365	30	10	5378-5023 N4



Measuring spoons, blue



Volumetric and dosing spoons can be used to measure small amounts of powder, granulates and liquids exactly and dose them precisely. For precise measuring, excess medium is stripped off the upper edge of the spoon. Available either in a large package with 100 pieces or 100 pieces packaged individually and radiation sterilised.

- ▶ PS, blue
- ▶ Optionally packaged individually and sterilised

Measuring spoons, blue

Capacity ml	Model	Pieces per pack	Item no.
0,5	large package	100	5378-4044 N4
0,5	sterilised, packaged individually	100	5378-4045 N4
1	large package	100	5378-4046 N4
1	sterilised, packaged individually	100	5378-4047 N4
2,5	large package	100	5378-4048 N4
2,5	sterilised, packaged individually	100	5378-4049 N4
5	large package	100	5378-4050 N4
5	sterilised, packaged individually	100	5378-4051 N4
10	large package	100	5378-4052 N4
10	sterilised, packaged individually	100	5378-4053 N4
15	large package	100	5378-4054 N4
15	sterilised, packaged individually	100	5378-4055 N4
25	large package	100	5378-4056 N4
25	sterilised, packaged individually	100	5378-4057 N4
50	large package	100	5378-4058 N4
50	sterilised, packaged individually	100	5378-4059 N4



Single-use tweezers, blue



The disposable forceps are suitable for precise lab work and are ideal for grasping, lifting and moving small objects, for example fine tissue, small items or solid samples.

- ▶ PS, blue
- ▶ Individually packaged and sterilised
- ▶ For single use
- ▶ Clean room manufactured (clean room class 7)
- ▶ Complies with EU food requirements and FDA regulations
- ▶ Overall length 130 mm



Single-use tweezers, blue



Shape	Pieces per pack	Item no.
pointed/angled	100	5378-1050 N4
pointed	100	5378-1051 N4
broad tip	100	5378-1052 N4

Scraper for foodstuffs, blue



The SteriPlast® scraper for foodstuffs, made of blue polystyrene, is produced in our class 7 clean room (10,000), individually packaged for disposable use and then sterilised by gamma rays.

Sturdy and convenient scraper for disposable use. The scraper is suitable for scraping off, smoothing or cleaning as well as removing residue.

- ▶ PS, blue
- ▶ Individually packaged and sterilised by gamma rays
- ▶ Production, assembly and packaging according to clean room class 7
- ▶ Complies with EU food requirements and FDA regulations

Scraper for foodstuffs, blue



L x W mm	Pieces per pack	Item no.
200 x 80	10	5378-3030 N4

Food palette knife spatula



The sampling palette knife spatula can be used to apply, distribute or evenly spread viscous media such as pastes and creams. The palette knife spatula reaches easily into the corners and curves of various containers and is suitable for scraping out bowls, removing residue or wiping off Bürkle's volumetric and dosing spoons.

- ▶ PS, blue
- ▶ Individually packaged and sterilised
- ▶ L x W 192 x 20 mm
- ▶ For single use
- ▶ Clean room manufactured (clean room class 7)
- ▶ Complies with EU food requirements and FDA regulations

Food palette knife spatula, blue



Pieces per pack	Item no.
100	5378-3035 N4

Blue disposable funnels for liquids



Disposable funnel for reliable filling of liquids, ideal for filling bottles and other containers with a narrow filler opening.

The disposable funnel ensures no loss when transferring liquid samples or free-flowing solids. That makes this practical and hygienic pouring aid a helpful accessory for sampling or in laboratories.

Clean room produced funnel with suspension eye and venting fins for ventilation to ensure uniform flow while pouring.

- ▶ PS, blue
- ▶ Clean room manufactured (clean room class 7)
- ▶ Individually packaged and sterilised



Blue disposable funnels for liquids

Outer dia. mm	Outlet dia. mm	Pieces per pack	Item no.
100	10	10	5378-6003 N4



Blue disposable powder funnels



The disposable powder funnel has a short, wide discharge and is suitable for transferring powdered samples and materials, granulates and suspensions as well as other liquids.

The wide opening of the disposable powder funnel prevents the powder or granulates from clogging while dispensing. That makes this practical and hygienic pouring aid a helpful accessory for sampling or in laboratories.

- ▶ PS, blue
- ▶ Clean room manufactured (clean room class 7)
- ▶ Individually packaged and sterilised



Blue disposable powder funnels

Outer dia. mm	Outlet dia. mm	Pieces per pack	Item no.
100	25	10	5378-6007 N4



DispoDipper



Sampling tube manufactured in a clean room specially designed for disposable use. Due to the blue colour, it is also perfect for use in the food, animal feed and pharmaceutical industries. The scaled sample container can be used for an exact measurement. After sampling, the container can be closed and is leakproof. The closed handle structure ensures secure handling. The sample container is available with 50 ml, 100 ml or 250 ml content. Depending on the design, container openings can be sampled from a diameter of 52 mm (2" barrel opening), 65 mm or 85 mm. This makes DispoDipper ideal for extracting samples from barrels, canisters and other containers. DispoDipper is completely manufactured in one piece and can be used for sampling and subsequent transport of the sample in one device. In this way, cross-contamination or sample impurities are impossible.

- ▶ PP, blue transparent
- ▶ Individually packaged and optionally sterilised by gamma rays
- ▶ Production and packaging according to clean room class 7
- ▶ Complies with EU food requirements and FDA regulations
- ▶ Scaled sampling tube volume in ml and oz.
- ▶ Immersion depth 270 mm

Use

1. For sampling, first unpack the sampler and detach the cover at the predetermined breaking point from the handle.
2. Afterwards extract the sample using the sample container and securely close with the cover.
3. After sampling, the handle at the predetermined breaking point can be detached from the sample container. This allows for easy and space-saving transport of the sample.



DispoDipper

Capacity ml	Model	Dia. mm	Height with cap mm	Total length mm	Pieces per pack	Item no.
50	standard	40	98	417	20	5393-7000 N4
50	sterilised	40	98	417	20	5393-7001 N4
100	standard	53	98	415	20	5393-7010 N4
100	sterilised	53	98	415	20	5393-7011 N4
250	standard	72	116	429	20	5393-7020 N4
250	sterilised	72	116	429	20	5393-7021 N4



Detectable disposable samplers



These scoops, spatulas, spoons and scrapers are not only coloured blue but also have a special additive in the material that makes them visible to metal detectors or X rays. These products can therefore be rejected with standard systems for checking for foreign objects, even though they are made of plastic.

- ▶ Can be detected by colour scanners, metal detectors or X-rays
- ▶ Can be used as part of HACCP/IFS/BRC foreign object management
- ▶ Especially for the food, animal feed and pharmaceutical industries
- ▶ PS detectable, blue
- ▶ Individually packaged and sterilised by gamma rays
- ▶ Production, assembly and packaging according to clean room class 7
- ▶ Complies with EU food requirements and FDA regulations

Detectable scoops, blue



Detectable SteriPlast® scoops, made of blue polystyrene, are produced in our class 7 clean room (10,000), individually packaged for disposable use and then sterilised by gamma rays.

Detectable scoops are ideal for powders, granulates and pastes.



Detectable scoops, blue

Capacity ml	Length mm	Pieces per pack	Item no.
25	141	10	5378-2001 N4
50	160	10	5378-2003 N4
100	205	10	5378-2005 N4
150	216	10	5378-2007 N4
250	232	10	5378-2013 N4
500	280	10	5378-2015 N4
1000	332	10	5378-2019 N4
2000	381	10	5378-2020 N4



Detectable scoop, long handle, blue



The sampling scoop can be used to take samples of powders, granulates and pastes. The long handle makes it possible to sample larger containers even with little content or to reach through narrow openings.

With the straight bottom of the scoop, the medium can be scooped up directly from the bottom of the container.

The disposable scoop is suitable for sensitive areas of pharmaceuticals and chemistry as well as the food and cosmetics industries.

- ▶ PS detectable, blue
- ▶ Individually packaged and sterilised
- ▶ Handle length 300 mm
- ▶ For single use
- ▶ Clean room manufactured (clean room class 7)
- ▶ Complies with EU food requirements and FDA regulations

Detectable scoop, long handle, blue

Total length mm	Capacity ml	Pieces per pack	Item no.
390	50	10	5378-5016 N4
415	100	10	5378-5020 N4



Detectable spatula, blue

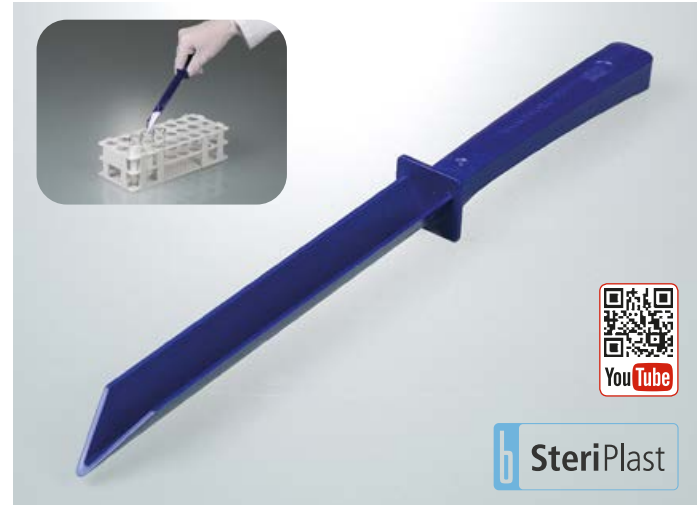

Detectable SteriPlast® spatulas, made of blue polystyrene, are produced in our class 7 clean room (10,000), individually packaged for disposable use and then sterilised by gamma rays.

As a result of the long, ergonomically-shaped, stable handle and a sharp blade, it is possible to even penetrate directly into containers such as paper or plastic sacks. Detectable spatula are ideal for sampling powders, granulates and pastes.

- ▶ PS detectable, blue
- ▶ Individually packaged and sterilised by gamma rays
- ▶ Production, assembly and packaging according to clean room class 7
- ▶ Complies with EU food requirements and FDA regulations

Detectable spatula, blue

Total length mm	Insertion depth mm	Pieces per pack	Item no.
263	150	10	5378-2009 N4



Detectable spoon, blue



Detectable SteriPlast® spoons, made of polystyrene, are produced in our class 7 clean room (10,000), individually packaged for disposable use and then sterilised by gamma rays.

The detectable spoons are available in two sizes, 2.5 ml (similar to a teaspoon) and 10 ml (similar to a tablespoon), and are ideal for sampling powders, granulates and fluids.

- ▶ PS detectable, blue
- ▶ Individually packaged and sterilised by gamma rays
- ▶ Production, assembly and packaging according to clean room class 7
- ▶ Complies with EU food requirements and FDA regulations



Detectable spoon, blue

Length mm	Capacity ml	Pieces per pack	Item no.
127	2.5	100	5378-2011 N4
170	10	100	5378-2012 N4



Detectable spoon, long handle, blue



Detectable spoon, long handle, blue

The long handle makes it easy to reach the bottoms of larger containers as well and allows for sampling of drums, jerrycans and bottles with small opening diameters.

Detectable spoon curved, long handle, blue

The long handle of the plastic spoon makes it possible to empty residue from large containers easily and can also reach into places that are hard to reach such as jerrycans with narrow necks.

- ▶ Handle length 300 mm
- ▶ For single use
- ▶ Clean room manufactured (clean room class 7)
- ▶ Complies with EU food requirements and FDA regulations
- ▶ PS detectable, blue
- ▶ Individually packaged and sterilised

Detectable spoon, long handle, blue

Total length mm	Capacity ml	Pieces per pack	Item no.
355	5	10	5378-5004 N4
375	20	10	5378-5008 N4



Detectable spoon curved, long handle, blue

Total length mm	Capacity ml	Pieces per pack	Item no.
360	10	10	5378-5012 N4



Ladle, long handle, detectable



- ▶ PS detectable, blue
- ▶ Individually packaged and sterilised
- ▶ Reaches into any corner
- ▶ Handle length 300 mm
- ▶ For single use
- ▶ Clean room manufactured (clean room class 7)
- ▶ Complies with EU food requirements and FDA regulations

The ladle is suitable for taking samples of liquids and viscous media as well as powders and granulates. The ladle has a very smooth bottom and rounded corners. This makes it possible to reach into any corner of a container or to take medium directly from the bottom of the container.

A long handle with indentations for fingers ensures a firm hold and precise work.

The disposable ladle can be used in the pharmaceutical industry, chemistry and cosmetics and the food and animal feed industries.

Ladle, long handle, detectable

Total length mm	Capacity ml	Pieces per pack	Item no.
365	30	10	5378-5024 N4



Detectable volumetric spoon, blue



Volumetric and dosing spoons can be used to measure small amounts of powder, granulates and liquids exactly and dose them precisely. For precise measuring, excess medium is stripped off the upper edge of the spoon. The content volume is engraved on the handle.

- ▶ PS detectable, blue
- ▶ Individually packaged and sterilised
- ▶ With stripper edge
- ▶ For single use
- ▶ Clean room manufactured (clean room class 7)
- ▶ Complies with EU food requirements and FDA regulations



Detectable volumetric spoon, blue

Capacity ml	Pieces per pack	Item no.
0,5	100	5378-4085 N4
1	100	5378-4087 N4
2,5	100	5378-4089 N4
5	100	5378-4091 N4
10	100	5378-4093 N4
15	100	5378-4095 N4
25	100	5378-4097 N4
50	100	5378-4099 N4



Palette knife spatula, detectable



The sampling palette knife spatula can be used to apply, distribute or evenly spread viscous media such as pastes and creams. The palette knife spatula reaches easily into the corners and curves of various containers and is suitable for scraping out bowls, removing residue or wiping off Bürkle's volumetric and dosing spoons. The dimensionally stable long edge of the plastic scraper is ideal for cutting viscous media. A small tip on the long edge can be used for ripping, for example packaging film. The scraper is also suitable for stirring and blending. The disposable sampling palette knife spatula is suitable for use in the pharmaceutical industry, chemistry, cosmetics and food & beverage.

- ▶ PS detectable, blue
- ▶ Individually packaged and sterilised
- ▶ L x W 192 x 20 mm
- ▶ For single use
- ▶ Clean room manufactured (clean room class 7)
- ▶ Complies with EU food requirements and FDA regulations

Palette knife spatula, detectable, blue			
Pieces per pack	Item no.		
100	5378-2035	N4	

Detectable funnels for liquids



The detectable disposable funnel for liquids made of detectable blue polystyrene is produced in clean room class 7 (10,000), individually packaged for disposable use and then sterilised.

- ▶ PS detectable, blue
- ▶ Clean room manufactured (clean room class 7)
- ▶ Individually packaged and sterilised



Detectable funnels for liquids

Outer dia. mm	Outlet dia. mm	Pieces per pack	Item no.
100	10	10	5378-6004

Detectable powder funnels



The detectable disposable powder funnel made of detectable blue polystyrene is produced in clean room class 7 (10,000), individually packaged for disposable use and then sterilised.

- ▶ PS detectable, blue
- ▶ Clean room manufactured (clean room class 7)
- ▶ Individually packaged and sterilised

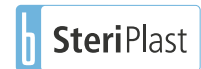

Detectable powder funnels

Outer dia. mm	Outlet dia. mm	Pieces per pack	Item no.
100	25	10	5378-6008

Detectable scraper, blue



The detectable SteriPlast® scraper, made of polystyrene, is produced in our class 7 clean room (10,000), individually packaged for disposable use and then sterilised by gamma rays.

Sturdy and convenient scraper for disposable use. The detectable scraper is suitable for scraping off, smoothing or cleaning as well as removing residue.

- ▶ PS detectable, blue
- ▶ Individually packaged and sterilised by gamma rays
- ▶ Production, assembly and packaging according to clean room class 7
- ▶ Complies with EU food requirements and FDA regulations



Detectable scraper, blue

L x W mm	Pieces per pack	Item no.	
200 x 80	10	5378-2030	N4



Stainless steel scraper



The high-quality scraper is suitable for scraping off, smoothing, cleaning, levelling out and also for removing strongly adhesive, sticky substances or dried up media. The edge of the corrosion-resistant stainless steel scraper is ideal for blending and portioning viscous media.

The smooth, seamless and sturdy surface ensures cleaning without difficulty and meets hygienic requirements.

The scraper makes a suitable implement for use in laboratories, production and clean rooms. It is ideal for use under rugged conditions in pharmaceuticals, chemistry, cosmetics, animal feed and food & beverage.

- ▶ High-grade stainless steel V4A (1.4404), for ideal chemical resistance
- ▶ Extra sturdy design guarantees long service life
- ▶ Sterilisable, autoclavable

Stainless steel scraper

Length mm	Width mm	Item no.	
230	75	5386-0030	N4
270	100	5386-0035	N4



Detectable forceps, sterile



The disposable forceps are suitable for precise lab work and are ideal for grasping, lifting and moving small objects, for example fine tissue, small items or solid samples.

- ▶ PS detectable, blue
- ▶ Individually packaged and sterilised
- ▶ For single use
- ▶ Clean room manufactured (clean room class 7)
- ▶ Complies with EU food requirements and FDA regulations
- ▶ Overall length 130 mm

Detectable forceps, sterile

Shape	Pieces per pack	Item no.	
pointed/angled	100	5378-1060 N4	
pointed	100	5378-1061 N4	
broad tip	100	5378-1062 N4	

Forceps, stainless steel



- ▶ Stainless steel AISI 304 (1.4301)
- ▶ Flutings at the ends and grip for secure handling

Forceps, stainless steel, sharp, bent form

Total length mm	Item no.			
105	5386-0100 N4			
130	5386-0102 N4			
160	5386-0104 N4			

Forceps, stainless steel, blunt, straight

Total length mm	Item no.			
105	5386-0300 N4			
130	5386-0302 N4			
160	5386-0304 N4			

Forceps, stainless steel, sharp, straight

Total length mm	Item no.			
105	5386-0200 N4			
130	5386-0202 N4			
160	5386-0204 N4			

Micro-spatula, disposable



Double scoop spatula with rounded ends, content 1.0 and 0.25 ml, total length 180 mm.

The micro spatula can be used to sample, transfer or process small amounts of chemicals, powders, granulates, pastes, creams or liquids.

The sturdy and convenient centre handle facilitates precise work.

Clean room manufactured, available either in a large package with 100 pieces or 100 pieces packaged individually and sterilised by gamma rays.

SteriPlast

LaboPlast



- ▶ PS
- ▶ Production, assembly and packaging according to clean room class 7
- ▶ Complies with EU food requirements and FDA regulations
- ▶ Optionally packaged individually and sterilised by gamma rays

Micro spatula stainless steel



The micro spatula can be used for reliably measuring, sampling or processing small amounts of powder, chemicals, pastes, creams or active ingredients. The laboratory scoop is made of stainless steel and is manufactured entirely without edges, crevices or undercuts. This excludes the possibility of impurities or cross-contamination, since no product residue or cleaning agents can be deposited.

The micro spatula is ideal for use in the pharmaceutical industry as well as food & beverage and cosmetics.

- ▶ Stainless steel AISI 304 (1.4301)
- ▶ High-gloss polished
- ▶ Contents 1.25 ml



Micro spatula stainless steel

Total length mm
170



Item no.
5386-0001 N4

Micro-spatula, disposable

Model	Pieces per pack	Item no.
Large package	100	5378-0032 N4
sterilised, packaged individually	100	5378-1032 N4

Spoon spatula stainless steel



The spatula-spoon can be used in many different applications. The double-sided multi-purpose spoon is a spoon on one side and a spatula on the other. This makes it possible to sample and process a variety of media such as powders, granulates, pastes and liquids. The spoon side of the spoon-spatula holds 4 ml or 11 ml respectively. Manufactured from a single piece of stainless steel, the spoon-spatula has no edges, crevices or undercuts. Because of this, product residue or cleaning agents cannot be deposited and the possibility of cross-contamination or impurities is excluded. That makes the poly-spoon ideal for use in chemistry, the pharmaceutical industry, cosmetics and the food industry.

- ▶ Stainless steel AISI 304 (1.4301)
- ▶ High-gloss polished
- ▶ Double-sided function

Spoon spatula stainless steel

Total length mm	Item no.
180	5386-0022 N4
300	5386-0025 N4

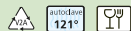

Spoon spatula, disposable



The spoon spatula is a double spatula with a 0.5 ml spoon and a 17 mm spatula blade, total length 178 mm.

The spoon spatula has many different uses in labs – as a sampling spoon, for measuring or transferring small amounts, as a scraper or for mixing and stirring. Specially designed for disposable use, resistant to chemicals and corrosion-proof. Clean room manufactured, available either in a large package with 100 pieces or 100 pieces packaged individually and sterilised by gamma rays.

- ▶ PS
- ▶ Production, assembly and packaging according to clean room class 7
- ▶ Complies with EU food requirements and FDA regulations
- ▶ Optionally packaged individually and sterilised by gamma rays



Spoon spatula, disposable

Model	Pieces per pack	Item no.
Large package	100	5378-0031 N4
sterilised, packaged individually	100	5378-1031 N4



Dosing spoon and measuring spoon set



Dosing and measuring spoons can be used to measure small amounts of powder, granulates and liquids exactly and dose them precisely. For precise measuring, excess medium is stripped off the upper edge of the spoon. The content volume is engraved on the handle.

The flat front edge of the volumetric spoon is ideal for picking up medium from the bottom of the container or for getting into the corners of the container, thus allowing for good emptying of small remaining amounts. The flat base makes it possible to set the volumetric spoon down without spilling the content.

An eyelet in the end of the handle can be used to hang up a spoon or to bundle several together.

- ▶ Content volume: 0.5; 1.0; 2.5; 5.0; 10; 15; 25; and 50 ml
- ▶ Set of volumetric spoons with eight sizes
- ▶ PS
- ▶ With stripper edge
- ▶ Complies with EU food requirements and FDA regulations

Dosing spoon and measuring spoon set

Colour	Capacity ml	Pieces per pack	Item no.
white	0,5 - 50	8	5378-4120 N4
blue	0,5 - 50	8	5378-4125 N4

Stainless steel measuring spoons



Stainless steel measuring spoon in a set of 4, as a measuring aid for fast and easy measuring from 1.25 to 15 ml. The volume is engraved on the handle of each measuring spoon.

- ▶ Stainless steel AISI 304 (1.4301)
- ▶ Volumes: 1.25 ml, 2.5 ml, 5 ml, 15 ml
- ▶ Spoon high-gloss finished, handle matt polished

Stainless steel measuring spoons

Capacity ml	Item no.
1.25 - 15	5334-8000 N4

Sample-spoon



Sampling spoon for withdrawing small quantities of samples. This specially shaped spoon lets you reach almost every corner in a container and prevents samples from trickling out.

- ▶ Made of AISI 304 (1.4301) stainless steel
- ▶ Largely chemical resistant (not against acids and alkalis)

Sample-spoon

Length mm	Capacity ml	Item no.
150	2	5320-0150 N4
180	2	5320-0180 N4
210	2	5320-0210 N4
300	9	5320-0300 N4
400	9	5320-0400 N4
500	9	5320-0500 N4

Measuring scoops



Universal graduated shovel for filling and measuring of powders and granules. For exact metering, the graduated shovel is to be overfilled and the excess at the upper edge of the shovel is to be wiped off.

- ▶ PP, white
- ▶ High chemical-resistance

Measuring scoops

Capacity ml	L x W mm	Item no.
2	60 x 21	9614-0002 N3
5	82 x 27	9614-0005 N3
10	100 x 34	9614-0010 N3
25	135 x 44	9614-0025 N3
50	160 x 55	9614-0050 N3
100	200 x 70	9614-0100 N3
250	260 x 90	9614-0250 N3
500	315 x 118	9614-0500 N3
1000	385 x 134	9614-1000 N3

PharmaScoop



This sample scoop PharmaScoop has been developed in order to meet the high requirements of the pharmaceutical industry, such as those contained in the FDA regulations. Like all samplers for the pharmaceutical industry, they are made of stainless steel AISI 316 without edges, crevices or undercuts in which sample residues could collect and contaminate subsequent samples. The highly polished inner and outer surfaces of the scoop therefore meet all the requirements for GMP compliance in production and sampling.

- ▶ Stainless steel AISI 316 (1.4404)
- ▶ GMP conform
- ▶ Highly polished

PharmaScoop					
Capacity ml	Dia. mm	Length mm	Item no.		
10	25	45	5324-0010	N4	
50	38	70	5324-0011	N4	
100	50	100	5324-0012	N4	
500	95	140	5324-0018	N4	
750	95	210	5324-0013	N4	
1000	110	235	5324-0014	N4	
1250	125	195	5324-0015	N4	
1700	135	230	5324-0016	N4	
2500	185	215	5324-0017	N4	
PharmaScoop with long handle					
Capacity ml	Dia. mm	Length mm	Total length mm	Item no.	
1000	110	235	835	5324-0019	N4

EasyScoop



When sampling bulk goods with a high specific weight, conventional scoops subject the user's wrist to great stress. EasyScoop with its centrally arranged inner grip is ergonomically designed and ensures easy and safe work. As EasyScoop is considerably shorter than conventional scoops, it is easier to take samples from narrow containers.

- ▶ Made of light aluminium, bright-anodised

EasyScoop				
Capacity ml	Length mm	Weight g	Item no.	
1500	200	325	5356-1500	N2
2000	300	575	5356-2000	N2

Scoop AISI 304



The stainless steel scoop can be used for taking samples of powders, granulates and pastes. Made of stainless steel AISI 304 (1.4301), the material is sterilisable and autoclavable. The rustproof stainless steel scoop has a smooth, high-gloss polished surface and is food-safe.

The tubular shape makes it easy to immerse the scoop in the medium being sampled. The high sides prevent the sample from trickling out. The round handle offers a good grip. The sturdy scoop is ideal for chemical, pharmaceutical, animal feed and food applications.

- ▶ Stainless steel AISI 304 (1.4301)
- ▶ Sterilisable
- ▶ Robust

Scoop AISI 304

Capacity ml	Dia. mm	Item no.			
120	50	5370-0120 N3			
450	75	5370-0450 N3			
1000	100	5370-1000 N3			
1500	120	5370-1500 N3			
2500	150	5370-2000 N3			

FoodScoop



Very stable hand scoop for various applications, particularly suited for the food industry. Seamless connection of scoop and hollow handle, therefore without crevices and edges. Especially smooth, highly polished surface.

- ▶ Especially sturdy model
- ▶ Stainless steel AISI 304 (1.4301)



FoodScoop

Capacity ml	Total length mm	L x W mm	Item no.			
100	215	120 x 60	5371-0100 N3			
200	230	140 x 75	5371-0200 N3			
250	245	155 x 85	5371-0250 N3			
350	290	180 x 100	5371-0350 N3			
500	350	220 x 130	5371-0500 N3			

Plastic scoops and scrapers

Iron scoops are loud, they can be dented, they rust and they are heavy. Plastic scoops have none of these disadvantages and are also hygienic because they are made in one piece and have a non-stick surface. They also have a high chemical resistance, they are unbreakable and, depending on the version, may be anti-static, anti-microbial, suitable for use with food and available in different colours (cadmium-free) – all valuable advantages!

Depending on the version the scoops may be anti-static, anti-microbial, suitable for use with food and available in different colours (cadmium-free).

The scoops and scrapers are made of polypropylene and contain additives for different applications:

- ▶ Industry: green
- ▶ Foodstuffs: white

Six products:

- ▶ Scraper with fixed handle
- ▶ Hand scoop
- ▶ Filling scoop, ideal for sampling
- ▶ 2-part shovel with D-grip
- ▶ 2-part shovel with T-grip
- ▶ 1-part shovel reduces contamination

Pharmaceuticals, biotechnology, foods, feed, chemistry, industry, agriculture, fish farming, sampling, veterinary use.

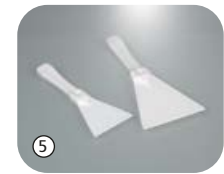

Scoops and scrapers for foodstuffs

Polypropylene's easy-to-clean, smooth and pore-free surface makes these scoops extremely suitable for the food sector. The scoops can be also used for boiling products.

- ▶ For foodstuffs (FDA and (EU) Nr. 10/2011)

① Hand scoops for foodstuffs							
L x W mm	Total length cm	Weight g	Item no.				
315 x 247	52.7	509	8300-1010 N3				
② Filling scoops for foodstuffs							
W x D x L mm	Total length cm	Weight g	Item no.				
110 x 150 x 250	25	90	8300-5010 N3				
138 x 187 x 310	31	187	8300-5011 N3				
167 x 230 x 355	35	289	8300-5012 N3				
③ 1-part shovels for foodstuffs							
Handle	W x D x L mm	Total length cm	Weight g	Item no.			
D	279 x 362 x 1107	111	1564	8300-0010 N3			
D	347 x 410 x 1100	110	1882	8300-0011 N3			
④ 2-part shovel for foodstuffs							
Handle	W x D x L mm	Total length cm	Weight g	Item no.			
T	247 x 315 x 966	97	1040	8300-2010 N3			
⑤ Scrapers for foodstuffs							
L x W mm	Weight g		Item no.				
205 x 75	44		8300-4011 N3				
250 x 110	80		8300-4010 N3				

Plastic scoops and scrapers



Scoops and scrapers for industry

With anti-static additive, ideal for robust use in chemistry and industry. Polypropylene has a high resistance to chemicals and temperatures. The scoops are unbreakable, easy to clean and light-weight.

► Anti-static



① Hand shovel for industry

L x W mm	Total length cm	Weight g	Item no.
315 x 247	51.5	509	8300-1003 N3
350 x 257	58.7	810	8300-1001 N3

② Filling scoops for industry

W x D x L mm	Total length cm	Weight g	Item no.
110 x 150 x 250	25	90	8300-5001 N3
138 x 187 x 310	31	187	8300-5002 N3
167 x 230 x 355	35	289	8300-1002 N3

③ 2-part shovel for industry

Handle	W x D x L mm	Total length cm	Weight g	Item no.
T	247 x 315 x 966	97	1004	8300-2001 N3
D	257 x 350 x 1045	104.5	1280	8300-3006 N3

④ Scrapers for industry

L x W mm	Weight g	Item no.
205 x 75	44	8300-4001 N3
250 x 110	80	8300-4002 N3

Meat sampler for carcass sampling

Meat sampler for microbiological sampling of carcass surfaces. The samplers for carcass sampling are similar to a cork drill. They can be used in the punch process (a destructive process, also called the cork drill or excision process) to remove a circular sample of tissue of 5 cm² from the surface. After the punch sample is cut out, it is removed from the carcass with a scalpel and tweezers. The sampling drills can also be used for other sampling purposes including histology, medicine, the food and luxury items industries, cheese factories and agriculture. The sharp cutting edge made of stainless steel makes it easy to cut out sample pieces. A hole in the crown prevents air compression and is also used to eject the samples. The samplers are easy to sterilise, for example by flaming or steam sterilisation.

- ▶ For sampling in accordance with DIN EN ISO 17604:2015-12
- ▶ Cutting surface Ø 25 mm



Single-use tweezers, blue see page 142
Detectable forceps, sterile see page 151

BeefSteaker



The BeefSteaker meat sampler for manually cutting out a piece of tissue for microbiological sampling of carcass surfaces. The core bit is drilled in by hand.



BeefSteaker

Dia. mm	Item no.
25	5388-1000 N4



Drill head for carcass sampling



The drill head for carcass sampling has a hexagonal socket for bit holders or chucks, suitable for all commonly used cordless screwdrivers or drilling machines.

Drill head for carcass sampling

Dia. mm	Item no.
25	5388-1010 N4



IceSampler



Sampler developed for sampling from frozen, highly viscous, paste-like materials such as ice-cream and similar substances. The drill-shaped cutter screws itself into the frozen goods independently when being rotated. The collection cylinder can easily be detached via a bayonet connection. The sample is then available and can be removed.

- ▶ Stainless steel AISI 316L (1.4404), electro-polished
- ▶ Sterilisable
- ▶ Easy cleaning
- ▶ Collection cylinder Ø 38 mm

IceSampler

Length mm	Volume ml	Item no.
300	50	5339-0300 N2
550	50	5339-0550 N2
1050	50	5339-1050 N2

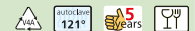

Ice borer | for deep-frozen and semi-solid substances

Sampler for deep-frozen products in the food and luxury items sector and for semi-solid substances. The very robust hollow drill cuts quickly into the sample material with its sharp sawing crown. A sample cylinder (cross-section sample) can be cut out.

The ice drill can be mounted on your standard commercial drilling machine. The core bit drills quickly and easily down to the desired depth in the frozen material. This makes it possible to cut a representative core sample from all layers of the frozen medium without expending any great effort. Drilling core samples can be taken from a drilling depth of up to 100 or 200 mm, depending on the design. The ejector makes it easy to release the sample from the drill head.

Made of stainless steel AISI 316, the drill is sterilisable and suitable for use with foods. The ice drill is ideal for quality control in the food and animal feed industries and is also suitable for example for sampling frozen meat for meat inspections. Other deep-frozen substances can be sampled easily as well with the sampling drill, for example frozen liquids.

- ▶ Stainless steel AISI 316L (1.4404) / AISI 316 Ti (1.4571)
- ▶ Sterilisable
- ▶ Cross-section sample



Ice borer

Inner dia. mm	Outer dia. mm	Drilling depth mm	Item no.
8	10	100	5323-0190 N4
16	21	200	5323-0200 N4
50	54	200	5323-2010 N4

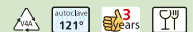

Soil sampler GeoSampler |



Soil sampler for light soils, meadows and lawns. The foot bar of model 5350-5006 makes work much easier.

- ▶ Stainless steel

Soil sampler GeoSampler

Model	Total length cm	Flute length mm	Outer dia. mm	Inner flute dia. mm	Weight g	Item no.
without foot bar	56	300	17	11	550	5350-5003 N2
with foot bar	81	300	20	14	1500	5350-5006 N2

Soil sampler Puerckhauer |



Very robust Puerckhauer-sampler for heavy and stony soils. Model 5350-5018 has a conically-tapered 60 cm tip which makes it much easier to extract the driven-in sampler. Ideal for N-min sampling 0–90 cm.

- ▶ Depth graduation 10 cm divisions
- ▶ Attachable handle, with non-slip plastic grips
- ▶ Reinforced impact head
- ▶ Stainless steel

Soil sampler Puerckhauer

Total length cm	Flute length mm	Outer dia. top mm	Outer dia. bottom mm	Inner flute dia. mm	Weight g	Item no.
81	600	20	20	13	2400	5350-5012 N2
117.5	1000	28	25	18	3800	5350-5018 N2

Mole with handle and bar



Very robust model with specially hardened forged drill bits. For determining soil properties, moisture and structure. The shape of the Mole's drill bits ensures minimum friction when drilling and removing the Mole from the ground. This reduces physical effort to a minimum.

The Mole has different components. Handle with 75 cm rod, extension rod 100 cm if necessary and one of seven available drill bits, each of which is designed for a particular soil type. The components can be combined without any problems. Extension rods can extend the working depth of the Mole down to 5 m.

Please order drill bits separately!

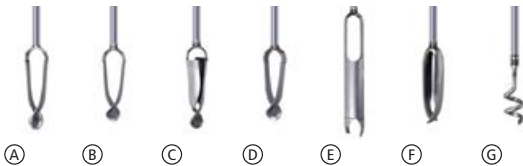

① Mole with handle and bar		
Model	Length cm	Item no.
handle with rod, without drill bit	75	5350-1005 N4
📦 Accessories		
Description		Item no.
② Extension for mole		5350-1010 N4
Transport case LxWxH 123x25x11 cm		3600-2120 N4

Drill bits for mole

There are various drill bits for Mole, which are each designed for very specific soil properties:

Ⓐ Clay and damp soil

With narrow side panels for minimum soil friction/resistance. As wet soils are usually very cohesive, the soil still adheres to the bit very well.

Ⓑ Sand

With broad side panels and therefore a large retention capacity for the sand.

Ⓒ Coarse sand

With extra broad side panels enclosing even more of the bit so that even coarse sandy soils and very dry soils are retained.

Ⓓ Combination

Retains both strongly cohesive and less cohesive soils.

Ⓔ Riverside

Very suitable for drilling in hard, encrusted soils and soils mixed with fine gravel. The drill cutters project from the drill itself, so that friction is greatly reduced.

Ⓕ Gravel drill

With slightly rounded, oblique scoops which pull themselves downward in the gravel. Any stones present are clamped between the drill sides. Finer soil material (coarse sand with fine gravel) is retained in the drill bit.

Ⓖ Stone catcher

The stone catcher is used to collect and remove stones that prevent proper sampling with one of the other drill bits.

③ Drill bits for mole

Model	Item no.
Ⓐ clay and wet soils	5350-1015 N4
Ⓑ sand	5350-1020 N4
Ⓒ coarse sand	5350-1025 N4
Ⓓ combination	5350-1030 N4
Ⓔ riverside	5350-1035 N4
Ⓕ gravel drill	5350-1040 N4
Ⓖ stone catcher	5350-1045 N4

MiniTherm



This immersion/insertion thermometer is suitable for measuring temperatures in gases, soft or powdered substances and liquids.

New: The mini thermometer in watertight design can simply be rinsed under flowing water or even cleaned in a dishwasher.

- ▶ Easy and quick battery replacement, battery included
- ▶ Sensor directly in the measuring tip
- ▶ Handy
- ▶ Many uses

MiniTherm



Model	Measuring range °C	Length mm	Dia. mm	IP Code	Item no.
standard	-50 to +150	133	4	41	5384-0011 N2
watertight	-20 to +230	120	4	67	5384-0012 N2

SnowPack® dry ice machine



SnowPack® enables you to obtain a -79 °C dry ice tablet weighing 50 or 250 g within a few moments, without complicated technology and without electricity! You can therefore obtain low-cost cooling to very low temperatures at any time you like.

SnowPack® is often used in hospitals, universities, schools, institutes, laboratories, in the chemical industry and in materials testing facilities.

Examples of use: Lowering the temperature in cooling baths or cold traps, pre-cooling tissue samples, ensuring safe transport or embedding biological substances, freezing blood and tissue samples, studies in chemistry, physics and materials technology, etc.

Dry ice is easy to handle, odourless and flavourless. The SnowPack® dry ice machine can be installed on any commercial CO2-bottle with a standpipe (without pressure regulator) (thread W 21.80 x 1/14" according to DIN 477-1 No. 6). These often exist in many production facilities and laboratories anyway. If this is not the case, a bottle can be rented for a small price from a local specialist gas distributor. For more info see page 242.

SnowPack® dry ice machine

Model	Tablet dia. x H mm	Weight g	Gas escape time approx. min	Tablets per 22 kg bottle	Item no.
SnowPack® 50	50 x 30	50	1	approx. 90	9805-0030 N4
SnowPack® 250	80 x 60	250	1	approx. 16	9805-0200 N4

Sample boxes, aseptic



Sample box with tightly closing sealing cover. The lid can be opened with one hand and its hinge angle is 90°. Liquid/condensate in the lid runs into an absorbing groove integrated in the lid, nothing is lost, nothing can drip. The box is completely tight, has no crevices, is therefore easy to fill and can be emptied without residues. The sample box is produced under aseptic conditions. It is autoclavable and suitable for deep freezing.

- ▶ PP, transparent
- ▶ Aseptic
- ▶ With area for labelling and with graduation

Sample boxes, aseptic

Capacity ml	Height mm	Dia. mm	Model	Item no.
50	78	31	with labelling area and graduation	6206-0060 N3
90	80	43	with labelling area and graduation at 80 ml	6206-0100 N3
300	88	75	graduated	6206-0300 N3



Tubes with screw cap



Shapely packing container with screw cap. Emptying without residues because there are no crevices, cost-effective.

- ▶ PP, white
- ▶ Sterilisable

Tubes with screw cap

Capacity ml	Dia. mm	Height mm	Item no.
12	25	31	6214-0012 N3
25	31	40	6214-0025 N3
60	41	56	6214-0060 N3
90	52	52	6214-0090 N3
125	52	67	6214-0125 N3
250	68	79	6214-0250 N3
625	90	113	6214-0600 N3
1000	102	129	6214-1000 N3



Sample beaker with cover



Sample beaker with liquid-tight red screw-on cover. The sample beakers are aseptic and suitable for use with food. The beakers can be autoclaved without the cover.

- ▶ PP beaker, LDPE cover
- ▶ Temperature resistance of beaker -20 °C/+120 °C, cover -80 °C/+75 °C
- ▶ Aseptic

Sample beaker with cover

Capacity ml	Dia. mm	Height mm	Item no.
125	52	74	7103-0125 N3



Aluminium bottle | light, unbreakable, seamless

Sealable wide-necked bottles



The aluminium bottle is particularly suited for storing, transport or sending substances and reference samples which have to be stored completely unaltered. Other properties: can be completely emptied without residues, odour-neutral, impervious to light, rustproof.

- ▶ Pure aluminium (material AL 99.5)
- ▶ With tamper-evident screw cap made of PP with aluminium/PET inner seal
- ▶ Suitable for food (exception: highly acidic and salt-containing foods)
- ▶ With UN approval (page 281)

Sturdy bottle with sealing eyelets on the screw cap and the bottle. Particularly suited for sending samples. Seals provide increased sample authenticity. Easy to fill due to wide opening. Particularly suitable for viscous media, powder, granules and pastes.

- ▶ HDPE
- ▶ Leakproof
- ▶ Easy to fill due to wide-necked opening

Aluminium bottle

Capacity ml	Dia. mm	Height with cap mm	UN approval	Item no.	
38	35	70	1B1/X/250	0327-0038	N3
60	40	88	1B1/X/250	0327-0060	N3
120	57	97	1B1/X/250	0327-0120	N3
300	57	160	1B1/X/250	0327-0300	N3
600	74	192	1B1/X/250	0327-0600	N3
1200	88	248	1B1/X/250	0327-1200	N3
3000	161	215	1B1/X/250	0327-3000	N3
5600	161	340	1B1/X/250	0327-5600	N3

Sealable wide-necked bottles

Capacity ml	Container dia. mm	Neck dia. inside mm	Height with cap mm	Item no.	
250	64	26.5	118	0322-0250	N3
500	78	40	147	0322-0500	N3
1000	100	50	186	0322-1000	N3
2000	120	50	230	0322-2000	N3

Accessories

Description	Price €	Item no.
SampleSafe seal, red, 100 pieces	74.70	5399-2902 N4

Table of contents containers



- 170 – 176 Narrow-necked bottles
- 177 – 180 Wide-necked bottles
- 181 – 187 Spray bottles, wash bottles and dropping bottles
- 188 – 189 Aluminium bottles
- 190 – 195 Boxes
- 193 – 195 Sample containers
- 196 – 202 Canisters, wide-mouth containers
- 198 – 199 Canister for flammable liquids
- 203 Storage/stacking containers
- 204 – 207 Tubs, big containers
- 208 – 209 Safety containers
- 210 – 211 Packaging buckets, packaging bags



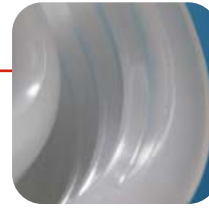

Containers

Bottles, tubes, jerry cans

Narrow-necked bottles for universal use | easy to handle and squeeze, reliable outflow



Universal bottles for storing, packing, lab, taking samples, sampling and transport of liquids.

- ▶ With screw cap
- ▶ LDPE, transparent

*** Bulk prices**

Narrow-necked bottles for universal use

Capacity ml	Container dia. mm	Height with cap mm	Neck dia. inside mm	Thread dia. mm	Item no.
10	26	47	9	14	0302-0010 N3
20	32	58	9	14	0302-0020 N3
30	35	67	9	14	0302-0030 N3
50	40	86	13	18	0302-0050 N3
100	45	106	13	18	0302-0100 N3
200	58	134	13	18	0302-0200 N3
250	60	140	18	25	0302-0250 N3
500	75	173	18	25	0302-0500 N3
1000	95	213	21	28	0302-1000 N3
2000	120	263	21	28	0302-2000 N3
3000	139	306	24	32	0302-3000 N3
5000	163	360	31	40	0302-5000 N3



Round bottles with snap closure



Handy round bottles with snap-action hinged lid, especially suited for cosmetic liquids, emulsions, creams and oils. Sampling possible per portion.

- ▶ Bottle HDPE transparent, closure PP
- ▶ Snap closure with hole Ø 3 mm
- ▶ Cost-effective and shapely

Bulk prices

Round bottles with snap closure

Capacity ml	Height with cap mm	Thread dia. mm	Item no.
100	115	22	0308-0100 N3
250	143	22	0308-0250 N3
500	182	25	0308-0500 N3
1000	221	25	0308-1000 N3

Tall-form bottles



Universal bottle for storing, packing, lab, sampling.

- ▶ LDPE, transparent
- ▶ Leakproof
- ▶ With screw cap
- ▶ Matching dropper cap is available as accessory

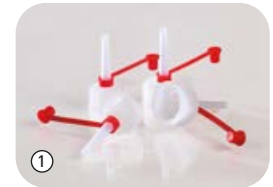

Tall-form bottles

Capacity ml	Dia. mm	Height mm	Neck dia. inside mm	Thread dia. mm	Item no.
100	45	98	13	18	0314-0100 N3
250	61	128	18	25	0314-0250 N3
500	77	162	18	25	0314-0500 N3
1000	95	198	21.6	28	0314-1000 N3

Accessories

Description	Item no.
① Dropper cap fits for thread dia. 18 mm	0300-3018 N3
① Dropper cap fits for thread dia. 25 mm	0300-3025 N3
① Dropper cap fits for thread dia. 28 mm	0300-3028 N3

The purity of disposable products and ecological sustainability combined perfectly!



With our LaboPlast® Bio and SteriPlast® Bio product lines, we offer you products that features all the properties for high-quality sampling.

The improved specifications in this area can in part only be realised with disposable products. However to take into account environmental awareness and to safeguard ecologically sustainable trade, we also offer these disposable products made of bio-plastic.



LaboPlast® bio-products are only manufactured from renewable raw materials. SteriPlast® bio-products are also sterilised by gamma rays. Bio-PE is 100 % recyclable and is manufactured without fossil raw materials. This also involves a CO₂ saving as well as a reduction of the greenhouse effect.



Sugarcane

100 % renewable raw material



100 % recyclable



I'm green

Green PE

Reduces CO₂ (2.9 t/t PE)

Reduces the greenhouse effect

b LaboPlast
Bio

b SteriPlast
Bio

Optimum product properties

- ▶ A perfect match for sampling purposes
- ▶ Complies with EU food requirements and FDA regulations
- ▶ Mainly manufactured, assembled and packed in Bürkle's own clean room
- ▶ SteriPlast® Bio sterilised by gamma rays is also available

Environmentally friendly and sustainable

- ▶ Product made of bio-plastic
- ▶ Made of sustainable raw materials, dispensing with fossil materials
- ▶ CO₂ saving and thus reduction of the greenhouse effect
- ▶ 100 % recyclable

Narrow-necked bio-bottles PE

The narrow-necked bio-bottles are manufactured from green PE biopolymer. This material has the same outstanding properties as conventional PE and can be recycled. However it is manufactured from renewable raw materials instead of fossils. Green PE therefore helps to reduce CO₂ emissions and protect the environment.

- ▶ With screw connection
- ▶ Manufactured from renewable raw materials
- ▶ Green LDPE



Narrow-necked bio-bottles PE

Capacity ml	Container dia. mm	Height with cap mm	Neck dia. inside mm	Thread dia. mm	Item no.
10	26	47	9	14	0303-0010 N3
20	32	58	9	14	0303-0020 N3
50	40	86	13	18	0303-0050 N3
100	45	106	13	18	0303-0100 N3
250	60	140	18	25	0303-0250 N3
500	75	173	18	25	0303-0500 N3
1000	95	213	21	28	0303-1000 N3



Narrow-necked square bottle



Cost-effective square bottle for packing and storing of liquids, powders and granules.

- ▶ HDPE, transparent, shatterproof
- ▶ Special labelling area for labels or manual lettering
- ▶ Leakproof

Narrow-necked square bottle

Capacity ml	L x W mm	Height with cap mm	Neck dia. inside mm	Thread dia. mm	Item no.
20	27 x 27	51	13	18	0331-0020 N3
50	33 x 34	77	13	18	0331-0050 N3
100	43 x 43	78	17.5	25	0331-0100 N3

Narrow-necked square bottle, screw cap



Cost-effective square bottle for packing and storing of liquids.

- ▶ HDPE, transparent, shatterproof
- ▶ Special labelling area for labels or manual lettering
- ▶ Suitable as a disposable bottle
- ▶ Leakproof
- ▶ With screw cap

Bulk prices

Narrow-necked square bottle with screw cap

Capacity ml	L x W mm	Height with cap mm	Thread dia. mm	Neck dia. inside mm	Item no.
100	41 x 33	113	18	13	0332-0100 N3
250	51 x 43	160	25	17.5	0332-0250 N3
500	68 x 53	182	25	17.5	0332-0500 N3
1000	89 x 66	230	25	17.5	0332-1000 N3

Accessories

Description	Item no.
Dropper cap fits for thread dia. 18 mm	0300-3018 N3
Dropper cap fits for thread dia. 25 mm	0300-3025 N3

Laboratory bottle PET sterile



Sterile laboratory bottle for use in laboratories and chemical handling areas. Good product presentation due to crystal-clear PET. Space-saving and absolutely leakproof. Ideal for storing and packing liquids.

- ▶ Sterile SAL 10⁻³ (according to ISO 11137)
- ▶ PET crystal-clear
- ▶ With tamper-proof closure (HDPE)
- ▶ With moulded-in raised graduation

Laboratory bottle PET sterile

Capacity ml	L x W mm	Height with cap mm	Neck dia. inside mm	Item no.
125	53 x 53	105	32	0370-0125 N3
250	64 x 64	132	32	0370-0250 N3
500	76 x 76	173	32	0370-0500 N3
1000	96 x 96	212	32	0370-1000 N3

UN-Bottle



This bottle reduces packaging costs! UN tested and approved. Bottle made of HDPE, leakproof, complete with PP tamper-evident closure with PTFE seal. The bottles are excellent for packaging purposes, sampling, sending samples, storage and shipping via the postal service.

- ▶ Absolutely leakproof
- ▶ With UN approval for liquids (page 281)
- ▶ Transparent
- ▶ Bell-shaped caps with or without degassing on request

UN-Bottle

Capacity ml	Height capless mm	Neck dia. inside mm	UN approval	Item no.
500	177	29	1H1/X1.9/250	0304-0500 N3
1000	212	29	3H1/X1.9/250	0304-1000 N3
2500	282	29	3H1/X1.9/250	0304-2500 N3

Narrow-neck reagent bottle



Universal bottles for storing, packing, taking samples, sampling and transport of liquids.

- ▶ HDPE, transparent
- ▶ PP tamper-evident screw cap, blue

Bulk prices

Narrow-neck reagent bottle

Capacity ml	L x W mm	Height capless mm	Thread dia. mm	Neck dia. inside mm	Item no.
100	45 x 45	108	32	17	0340-0100 N3
250	60 x 60	136	32	17	0340-0250 N3
500	74 x 74	170	32	17	0340-0500 N3
1000	85 x 85	221	32	17	0340-1000 N3
2500	122 x 122	272	45	28	0340-2500 N3



Wide-neck reagent bottle



The reagent bottle is particularly suited for storing, packing, taking samples, sampling and transport of granules and paste-like media.

- ▶ HDPE, transparent
- ▶ PP tamper-evident screw cap, blue
- ▶ UN approval for bulk goods (page 281)

Bulk prices

Wide-neck reagent bottle

Capacity ml	L x W mm	Height capless mm	Thread dia. mm	Neck dia. inside mm	UN approval	Item no.
50	36 x 36	89	28	21	no	0342-0050 N3
100	45 x 45	101	32	24	UN3H1/X0.3	0342-0100 N3
250	59 x 59	130	45	35	UN3H1/X0.8	0342-0250 N3
500	75 x 75	162	54	43	UN3H1/X1.5	0342-0500 N3
750	83 x 83	188	54	43	UN3H1/X2.5	0342-0750 N3
1000	85 x 85	214	54	43	UN3H1/X2.5	0342-1000 N3
1500	108 x 108	209	80	69	UN3H1/X4	0342-1500 N3
2500	122 x 122	260	80	69	UN3H1/X5	0342-2500 N3
4000	142 x 142	294	80	69	UN3H1/X5.5	0342-4000 N3



Wide-necked bottle | easy to fill and clean, compact form, unbreakable



Sturdy bottle with wide-necked opening and screw cap. Particularly suitable for viscous media, powder, granules and pastes. Leakproof.

- ▶ LDPE or PP
- ▶ LDPE coloured brown for light-sensitive liquids

Individual customer-specific printing possible - please ask us!

Wide-necked bottle

Material	Capacity ml	Colour	Dia. mm	Height mm	Neck dia. inside mm	Thread dia. mm	Item no.
LDPE	50	transparent	40	80	24	32	0318-0050 N3
LDPE	100	transparent	48	95	24	32	0318-0100 N3
LDPE	200	transparent	59	114	30	40	0318-0200 N3
LDPE	250	transparent	64	127	31	40	0318-0250 N3
LDPE	500	transparent	77	158	39	50	0318-0500 N3
LDPE	750	transparent	88	176	39	50	0318-0750 N3
LDPE	1000	transparent	94	207	50	65	0318-1000 N3
LDPE	1500	transparent	108	232	50	65	0318-1500 N3
LDPE	2000	transparent	120	252	50	65	0318-2000 N3
PP	100	transparent	48	95	24	32	0319-0100 N3
PP	250	transparent	64	127	31	40	0319-0250 N3
PP	500	transparent	77	158	39	50	0319-0500 N3
PP	1000	transparent	94	207	50	65	0319-1000 N3
LDPE	250	brown	64	127	31	40	0320-0250 N3
LDPE	500	brown	77	158	39	50	0320-0500 N3
LDPE	1000	brown	94	207	50	65	0320-1000 N3

Wide-necked square bottle



Cost-effective square bottle for packing and storing of liquids, powders and granules.

- ▶ HDPE, transparent, shatterproof
- ▶ Special labelling area for labels or manual lettering
- ▶ Leakproof

Wide-necked square bottle

Capacity ml	L x W mm	Height with cap mm	Neck dia. inside mm	Thread dia. mm	Item no.
250	59 x 59	110.5	30	50	0338-0250 N3
500	68 x 68	146	30	50	0338-0500 N3
1000	90 x 90	170	50	65	0338-1000 N3



Multi-Bottles with graduation



Bottle for universal use. The medium-sized bottle opening ensures good filling and safe pouring.

- ▶ Bottle HDPE, lid PP
- ▶ Embossed contents scale
- ▶ Absolutely leakproof
- ▶ With screw cap

Bulk prices

Multi-Bottles with graduation

Capacity ml	Container dia. mm	Height capless mm	Neck dia. inside mm	Division ml	Thread dia. mm	Item no.
100	46	99.5	19	25	25	0301-0100 N3
250	61	129.5	24	50	28	0301-0250 N3
500	76	161	30.8	50	40	0301-0500 N3
1000	97	203	39.2	100	50	0301-1000 N3



Sealable wide-necked bottles



Sealable wide-necked bottles

Capacity ml	Container dia. mm	Neck dia. inside mm	Height with cap mm	Item no.
250	64	26.5	118	0322-0250 N3
500	78	40	147	0322-0500 N3
1000	100	50	186	0322-1000 N3
2000	120	50	230	0322-2000 N3

Accessories

Description	Item no.
SampleSafe seal, red, 100 pieces	5399-2902 N4

Sturdy bottle with sealing eyelets on the screw cap and the bottle. Particularly suited for sending samples. Seals provide increased sample authenticity. Easy to fill due to wide opening. Particularly suitable for viscous media, powder, granules and pastes.

- ▶ HDPE
- ▶ Leakproof
- ▶ Easy to fill due to wide-necked opening

Spray bottle with pump vaporiser



b LaboPlast

Spray bottles with pump vaporiser and safety cap for the pump. Liquids can be finely vaporised at the push of a button in an environmentally compatible way. The transparent bottles make identification of contents easy. The protective cover prevents unintentional pressing of the pump and acts as a dust cover.

- Bottle made of HDPE, spray pump made of PP and stainless steel

Spray bottle with pump vaporiser

Capacity ml	Dia. mm	Height with cap mm	Item no.
20	28	85	0309-3002 N3
50	35	110	0309-3005 N3
100	37	161	0309-3100 N3
250	50	222	0309-3025 N3

Spray bottle



Pressureless spray bottle made of LDPE with long-life hand pump. The functioning of each individual sprayer is tested during manufacture.

Areas of application: Industry, laboratories, production, leisure, household. Suitable for agricultural pesticides and detergents.

- ▶ Media-contacting parts PP, PE and stainless steel
- ▶ Nozzle 0.6 mm diameter, nozzle steplessly adjustable
- ▶ Spray volume per stroke: 1.2 ml ± 0.1
- ▶ Temperature of the liquid: 0 - 30 ° C



Spray bottle

Capacity ml	Height with cap mm	Neck dia. inside mm	Item no.
250	220	18	0309-1025 N4
500	240	18	0309-1050 N4
1000	295	17.5	0309-1100 N4

Spray bottle Turn'n'Spray | Spray bottle with overhead valve



- ▶ Uninterrupted spraying, even overhead
- ▶ Parts in contact with media made of PP, PE, silicon and stainless steel
- ▶ Nozzle diameter 0.6 mm, nozzle is continuously adjustable
- ▶ Amount sprayed per stroke: 1.2 ml ± 0.1

Spraying at an angle or overhead is not possible with standard spray bottles. As soon as the suction tube is no longer immersed in liquid, you can't spray any more.

No so with our overhead spray bottle Turn'n'Spray. It features a special technology that allows you to spray from any position. That means you can spray practically and conveniently from any direction and reach hard-to-access places easily and without straining.

The high-quality, refillable quality spray bottle can be used again and again.

Spray bottle Turn'n'Spray

Capacity ml	Height with cap mm	Neck dia. inside mm	Item no.
250	220	18	0309-0002 N4
500	240	18	0309-0005 N4
1000	295	17.5	0309-0010 N4

Pressure sprayer



The pressure sprayer features rugged industrial quality for use in the chemical and pharmaceutical industry, for example disinfecting, cleaning, plant protection, thin-layer chromatography, technical and sanitary uses.

The practical 360° spray function also allows for upside-down spraying with the Turn'n'Spray pressure sprayer, making it easy to reach even places that are difficult to access. The sprayer can be used for many purposes, such as disinfecting and cleaning, or also for spraying plant protection products.

- ▶ Adjustable spray jet, nozzle diameter 0.8 mm
- ▶ Temperature of the liquid: 0 - 30 ° C
- ▶ Capacity of 1.5 litres
- ▶ Parts in contact with media PE, PP, FKM, AISI 316
- ▶ Upside-down spray function



Pressure sprayer

Capacity ml	Container dia. mm	Height with cap mm	Item no.
1500	140	305	0309-0100 N4

Pressure sprayer Turn'n'Spray

Capacity ml	Container dia. mm	Height with cap mm	Item no.
1500	140	305	0309-0120 N4

Accessories

Description	Item no.
Spraying lance extension for pressure sprayer, 30 cm	0309-0101 N4

Pressure sprayer Food



The food pressure sprayer has a transparent viewing window to make it easy to read the fill level. A rubber-coated ring stand ensures that the sprayer can be set down securely. The built-in safety valve protects against overpressure (max. 3 bar). The adjustable nozzle nut makes it possible to regulate the spray jet individually – from a fine spray mist to a powerful jet. The ergonomic handle provides a comfortable hold on the pressure sprayer. The food-safe spray bottle is specially designed for use in the food industry and is well suited for spraying different media including oils, greases or flavouring substances. It can also be used to easily atomise cleaning and disinfecting agents.

- ▶ Parts in contact with media PE, PP, VMQ, AISI 304
- ▶ Capacity of 1.2 litres

Pressure sprayer Food

Capacity ml	Container dia. mm	Height with cap mm	Item no.
1200	117	315	0309-0130 N4

Wide-necked wash bottle



Wash bottle with medium overprint as well as hazard and safety instructions (health statements/physical statements) based on the GHS system with substance name in German, English, French and Spanish, GHS pictograms and CAS number.

- ▶ Safe filling due to wide-necked opening 39 mm (neck dia. inside)
- ▶ LDPE yellow transparent with light protection
- ▶ Contents 500 ml



Wide-necked wash bottle

Print	Colour	Item no.		
without label - neutral	yellow	0310-3050	N3	
Distilled water	transparent	0310-3051	N3	
Methanol	green	0310-3052	N3	
Ethanol	orange	0310-3053	N3	
Isopropanol	blue	0310-3054	N3	
Acetone	red	0310-3055	N3	

Safety wash bottle

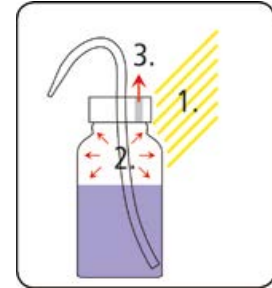

The vapour-permeable membrane reliably prevents leaking of the contents.

If the room temperature increases, or the sun shines into the lab, conventional wash bottles will drip because of the increased inner pressure. The venting valve ensures that the excess pressure can escape and dripping is prevented. With leakproof venting valve, contents cannot leak when bottle has fallen over as with wash bottles with ball valve or venting hole.

- ▶ Safe filling due to wide-necked opening 39 mm (neck dia. inside)
- ▶ Permanent print according to GHS with substance name in German, English, French and Spanish, GHS pictograms and CAS number
- ▶ LDPE yellow transparent with light protection
- ▶ Contents 500 ml



Safety wash bottle

Print	Colour	Item no.		
without label - neutral	yellow	0310-2056	N3	
Distilled water	transparent	0310-2050	N3	
Methanol	green	0310-2052	N3	
Ethanol	orange	0310-2054	N3	
Isopropanol	blue	0310-2055	N3	
Acetone	red	0310-2051	N3	

Wash bottle



The swan-neck jet produces a fine, straight spray with no lateral spatter. Dangerous lateral spatter does not occur.

- ▶ LDPE
- ▶ Transparent
- ▶ Immersion tube can be pulled up



Wash bottle

Capacity ml	Dia. mm	Height mm	Item no.
100	45	200	0310-0010 N3
250	61	225	0310-0025 N3
500	75	270	0310-0050 N3
1000	98	315	0310-0100 N3

Dropping bottles | for controlled dosing drop by drop



Dropping bottles are particularly suitable for liquids which must be dispensed in small amounts, drop by drop or as a fine jet.

- ▶ Cut off dropper tip before first use
- ▶ Can be reclosed using the captive cap provided
- ▶ LDPE
- ▶ Captive cap and dropper cap PE



Dropping bottles

Capacity ml	Container dia. mm	Height with cap mm	Neck dia. inside mm	Thread dia. mm	Item no.
10	26	76	9	14	0306-0010 N3
20	32	88	9	14	0306-0020 N3
30	35	96	9	14	0306-0030 N3
50	40	116	13	18	0306-0050 N3
100	45	136	13	18	0306-0100 N3
250	61	170	18	25	0306-0250 N3
500	75	204	18	25	0306-0500 N3
1000	95	248	21	28	0306-1000 N3

Drop-Boy



Bottle with drop dispenser and separate screw cap.

- ▶ Cut off dropper tip before first use
- ▶ Reclosable
- ▶ Precise drop dosing

Drop-Boy

Capacity ml	Dia. mm	Height capless mm	Item no.	
10	24	50	0307-0010	N3
25	31.3	64.5	0307-0025	N3
50	40	77	0307-0050	N3

Bottle carrier



For 6 bottles up to max. 95 mm Ø.

- ▶ PP
- ▶ Suitable for food

Bottle carrier

No. of bottles	Container dia. mm	Outer dimension of rim L x W x H mm	Item no.		
6	95	310x210x310	0361-0006	N3	

Bottle carrier box

No. of bottles	Container dia. mm	Outer dimension of rim L x W x H mm	Item no.	
8	95	400x290x215	0361-0008	N3

Bottle carrier box



For 8 bottles up to max. 95 mm Ø. With closed floor which can be used as spill trough.

- ▶ HDPE
- ▶ Inside measurements: Length 330 mm, width 100 mm
- ▶ Collecting volume: 3.9 litres per side

Aluminium bottle | light, unbreakable, seamless

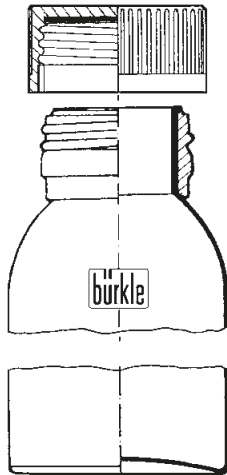

The aluminium bottle is particularly suited for storing, transport or sending substances and reference samples which have to be stored completely unaltered. Other properties: can be completely emptied without residues, odour-neutral, impervious to light, rustproof.

- ▶ Pure aluminium (material AL 99.5)
- ▶ With tamper-evident screw cap made of PP with aluminium/PET inner seal
- ▶ Suitable for food (exception: highly acidic and salt-containing foods)
- ▶ With UN approval (page 281)



Aluminium bottle

Capacity ml	Dia. mm	Height with cap mm	UN approval	Item no.
38	35	70	1B1/X/250	0327-0038 N3
60	40	88	1B1/X/250	0327-0060 N3
120	57	97	1B1/X/250	0327-0120 N3
300	57	160	1B1/X/250	0327-0300 N3
600	74	192	1B1/X/250	0327-0600 N3
1200	88	248	1B1/X/250	0327-1200 N3
3000	161	215	1B1/X/250	0327-3000 N3
5600	161	340	1B1/X/250	0327-5600 N3



Transport bottle aluminium UN | UN-approval for dangerous goods



The UN code is printed onto the bottles in black.



With tamper-evident screw cap made of PP with aluminium/PET inner seal.



Aluminium transport bottles with screw cap close safely and tightly and are approved for packaging type I (X). The UN code is printed onto the bottles in black.

- ▶ Pure aluminium (material AL 99.5)
- ▶ UN approved (page 281)
- ▶ With eyelets, sealable

Transport bottle aluminium UN

Capacity ml	Dia. mm	Height mm	UN approval	Item no.
125	50	105	1B1/X/250	0329-0125 N3
250	65	140	1B1/X/250	0329-0250 N3
500	80	145	1B1/X/250	0329-0500 N3
1250	100	205	1B1/X/250	0329-1250 N3



Tubes with screw cap



Shapely packing container with screw cap. Emptying without residues because there are no crevices, cost-effective.

- ▶ PP, white
- ▶ Sterilisable

Wide-necked boxes, round



Wide-necked containers with very good shatter resistance for convenient filling. Particularly suited for storing or shipping powders and granules.

- ▶ HDPE, transparent, shatterproof
- ▶ Screw lid made of PP with seal made of PE

Bulk prices

Tubes with screw cap

Capacity ml	Dia. mm	Height mm	Item no.
12	25	31	6214-0012 N3
25	31	40	6214-0025 N3
60	41	56	6214-0060 N3
90	52	52	6214-0090 N3
125	52	67	6214-0125 N3
250	68	79	6214-0250 N3
625	90	113	6214-0600 N3
1000	102	129	6214-1000 N3



Wide-necked boxes, round

Capacity ml	Dia. mm	Neck dia. inside mm	Height cap-less mm	Item no.
100	48	31	77	6282-0100 N3
250	65	41	98	6282-0250 N3
500	80	53	122	6282-0500 N3
750	94	53	130	6282-0750 N3
1000	100	67	153	6282-1000 N3
1500	114	67	173	6282-1500 N3
2000	126	67	192	6282-2000 N3



Wide-necked boxes, square shaped | clear or brown material



The wide opening of the container enables easy filling with liquid, powder or granules such as tablets, capsules, dyes, shipments of samples, specimens etc. Also suitable for gift packages and hobby articles. For light-sensitive material, brown transparent wide-necked containers are particularly suited.

- ▶ PETG crystal-clear
- ▶ PVC highly transparent or brown transparent
- ▶ Screw lid PP, black, seal made of PE

Wide-necked boxes, square shaped

Material	Capacity ml	Length mm	Width mm	Height with cap mm	Neck dia. inside mm	Item no.	
PETG crystal clear	50	38	38	63	23	0357-0050	N3
PETG crystal clear	100	46	46	75	31	0357-0100	N3
PETG crystal clear	200	59	59	91	41	0357-0200	N3
PETG crystal clear	500	80	80	111	54	0357-0500	N3
PETG crystal clear	1000	95	95	152	69	0357-1000	N3
PVC highly transparent	50	38	38	63	23	0355-0050	N3
PVC highly transparent	100	46	46	75	31	0355-0100	N3
PVC highly transparent	200	59	59	91	41	0355-0200	N3
PVC highly transparent	300	66	66	98	41	0355-0300	N3
PVC highly transparent	500	80	80	111	54	0355-0500	N3
PVC highly transparent	750	92	92	120	69	0355-0750	N3
PVC highly transparent	1000	95	95	152	69	0355-1000	N3
PVC highly transparent	2000	120	120	190	69	0355-2000	N3
PVC amber transparent	100	46	46	75	31	0356-0100	N3
PVC amber transparent	200	59	59	91	41	0356-0200	N3



All-purpose tubes with screw cap



Contents can be recognised easily due to the transparent sides. Emptying without residues.

- ▶ PP, transparent, screw lid PP
- ▶ No crevices

All-purpose tubes with screw cap; transparent

Capacity ml	Container dia. mm	Height mm	Item no.
250	104	50	6202-0250 N3
500	104	100	6202-0500 N3
1000	125	126	6202-1000 N3

All-purpose boxes, square



Box for storing, packing, taking samples, sampling and transport of pastes, granules, powders, soil samples and frozen goods (-40 °C up to briefly +95 °C). Ideal use of space, can be stacked. Complete with press-in lid.

- ▶ PE, transparent
- ▶ Can be deep frozen
- ▶ No crevices

All-purpose boxes, square shaped

Capacity ml	L x W x H mm	Item no.
500	103 x 103 x 64	6250-0500 N3
1000	103 x 103 x 127	6250-1000 N3
1000	208 x 103 x 64	6250-1001 N3
1500	208 x 103 x 94	6250-1500 N3
2000	208 x 208 x 64	6250-2000 N3
2000	255 x 103 x 94	6250-2300 N3
3200	208 x 208 x 94	6250-3300 N3

All-purpose boxes, round

Capacity ml	Outer dia. bottom mm	Outer dia. top mm	Height mm	Item no.
250	60	78	90	6210-0250 N3
500	75	95	127	6210-0500 N3
1000	118	136	110	6210-1001 N3
2000	148	169	143	6210-2000 N3

Sample boxes, aseptic



Sample box with tightly closing sealing cover. The lid can be opened with one hand and its hinge angle is 90°. Liquid/condensate in the lid runs into an absorbing groove integrated in the lid, nothing is lost, nothing can drip. The box is completely tight, has no crevices, is therefore easy to fill and can be emptied without residues. The sample box is produced under aseptic conditions. It is autoclavable and suitable for deep freezing.

- ▶ PP, transparent
- ▶ Aseptic
- ▶ With area for labelling and with graduation

*** Bulk prices**

Sample boxes, aseptic				
Capacity ml	Height mm	Dia. mm	Model	Item no.
50	78	31	with labelling area and graduation	6206-0060 N3
90	80	43	with labelling area and graduation at 80 ml	6206-0100 N3
300	88	75	graduated	6206-0300 N3



Sampling tube manufactured in a clean room specially designed for disposable use. Due to the blue colour, it is also perfect for use in the food, animal feed and pharmaceutical industries. The scaled sample container can be used for an exact measurement. After sampling, the container can be closed and is leakproof. The closed handle structure ensures secure handling. The sample container is available with 50 ml, 100 ml or 250 ml content. Depending on the design, container openings can be sampled from a diameter of 52 mm (2" barrel opening), 65 mm or 85 mm. This makes DispoDipper ideal for extracting samples from barrels, canisters and other containers. DispoDipper is completely manufactured in one piece and can be used for sampling and subsequent transport of the sample in one device. In this way, cross-contamination or sample impurities are impossible.

- ▶ PP, blue transparent
- ▶ Individually packaged and optionally sterilised by gamma rays
- ▶ Production and packaging according to clean room class 7
- ▶ Complies with EU food requirements and FDA regulations
- ▶ Scaled sampling tube volume in ml and oz.
- ▶ Immersion depth 270 mm

Use

1. For sampling, first unpack the sampler and detach the cover at the predetermined breaking point from the handle.
2. Afterwards extract the sample using the sample container and securely close with the cover.
3. After sampling, the handle at the predetermined breaking point can be detached from the sample container. This allows for easy and space-saving transport of the sample.



DispoDipper

Capacity ml	Model	Dia. mm	Height with cap mm	Total length mm	Pieces per pack	Item no.
50	standard	40	98	417	20	5393-7000 N4
50	sterilised	40	98	417	20	5393-7001 N4
100	standard	53	98	415	20	5393-7010 N4
100	sterilised	53	98	415	20	5393-7011 N4
250	standard	72	116	429	20	5393-7020 N4
250	sterilised	72	116	429	20	5393-7021 N4



Sample beaker with cover



Sample beaker with liquid-tight red screw-on cover. The sample beakers are aseptic and suitable for use with food. The beakers can be autoclaved without the cover.

- ▶ PP beaker, LDPE cover
- ▶ Temperature resistance of beaker -20 °C/+120 °C, cover -80 °C/+75 °C
- ▶ Aseptic

Sample beaker with cover

Capacity ml	Dia. mm	Height mm	Item no.
125	52	74	7103-0125 N3



Advertise with your good name

Many articles in this catalog are outstandingly suitable for carrying your advertisements. No matter whether as a promotional gift or as a supplement to your own product: your name is always present.

Printing subjects

Company logos, instructions for use, advertising messages, table of contents, scales – we set no limits to your fantasies or wishes.

Colors

We can print in all the usual color scales such as RAL, Pantone, HKS or to your color sample.

Printing area

The area that can be printed depends on the particular product. We will be pleased to advise you.

Resistance

The printing is resistant to weak acids and alkalis, and to most solvents. It is very resistant to both mechanical damage and light. Your advertising message will not fade even after many years of use.

From artwork to print

1. You send us your copy or artwork – we can process virtually any data format.
2. On request we can also support you with your a layout.
3. After a few days you will receive a proof sheet for your acceptance.
4. In our works your advertising message will be permanently applied in topquality.

Costs

We treat each print job individually. As each print job is different, we always make a separate offer for each inquiry. The total cost is made up of the price of the product, preliminary costs (finalizing the artwork and making the screen) and printing costs.

Printable products

- ▶ Measuring scoops (page 155)
- ▶ Bottles (page 170)
- ▶ Pressure atomiser (page 184)
- ▶ Graduated beakers (page 228)
- ▶ Graduated cylinders (page 230)
- ▶ Flow indicators (page 252)



Compact jerrycan | for more content on less shelf width

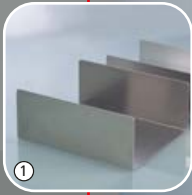

1



2

LaboPlast



YouTube



3



4



5

The compact jerrycan is ideal as a space-saving canister with its width of 6.5 cm or 12.5 cm. Different liquids can be stored and decanted in a small space. The compact jerrycan can also be stored lying on its side e. g. in a refrigerator. It is very stable due to ribbed structure and thick sides. Using the support stand (only for 5 l canister) for two or three canisters, any number of canisters can be placed safely and freestanding. The compact jerrycan can also be used as a settling canister.

Compact jerrycan | for more content on less shelf width



- ▶ With or without threaded connector 3/4"
- ▶ PP, transparent
- ▶ With tamper-proof closure
- ▶ Canister without stopcock and closure autoclavable
- ▶ With moulded, indestructible litre graduation
- ▶ Canister support made of aluminium for secure stand as accessory (only for 5 l canister)
- ▶ Spigot StopCock with rotatable discharge angle and Compact spigot, which fits canisters equipped with glands with threads 3/4", available as accessory

Compact jerrycan

Model	Capacity l	Width mm	Depth mm	Height mm	Opening dia. mm	Item no.
without threaded connector	5	65	335	335	41	0435-1050 N4
with threaded connector 3/4"	5	65	335	335	41	0435-2050 N4
without threaded connector	10	125	335	335	41	0435-1100 N4
with threaded connector 3/4"	10	125	335	335	41	0435-2100 N4

Accessories

Description	Item no.
① Support stand for two compact jerrycans (only for 5 l canister)	0435-9102 N4
① Support stand for three compact jerrycans (only for 5 l canister)	0435-9103 N4
⑨ Filling support for compact jerrycan 10 l	0435-9104 N4
② Venting valve in screw cap	0435-9200 N4
Closure cap 3/4"	0600-0090 N4
Tamper-evident closure DIN 50 for compact jerrycan	0300-0000 N4
③ StopCock angled (see page 40)	0525-1000 N4
④ Compact spigot (see page 41)	0530-1000 N4
⑤ Set consisting of one compact jerrycan 5 l and one spigot Compact	0435-3000 N4
⑥ Set consisting of one compact jerrycan 5 l and one spigot StopCock	0435-0001 N4
⑦ Set consisting of one compact jerrycan 10 l and one spigot Compact	0435-3010 N4
⑧ Set consisting of one compact jerrycan 10 l and one spigot StopCock	0435-0010 N4

Compact jerrycan, electroconductive



⚠ Caution! When working with combustible liquids, the canister must be earthed! Use anti-static set!

The compact jerrycan, made of electrically conductive HDPE, is especially well suited for use in explosion-proof areas. With a specific surface resistance of $<10^5$ ohms, the canister has a very high electrical conductivity. When correctly earthed, it prevents the danger of ignition due to an accumulation of electrostatic charge. The canister thus helps to meet the requirements of the ATEX 137, TRBS2153 and CENELEC 50404

guidelines. The plastic industrial canister is non-rusting and can be disposed of with no problems in the recycling system. It can be used for dispensing and storing combustible and highly flammable liquids of explosion groups IIA, IIB and IIC, such as laboratory waste in industrial applications or mining. Due to its narrow width of 6.5 cm or 12.5 cm, the space-saving canister requires very little room, making it suitable for use in very confined spaces. The ribbed structure and thick sides make it very stable and also allow for flat storage. The handle ensures secure handling and easy transport. For the version with 3/4" threaded connector, a stop cock can be mounted, for example the StopCock PA, which is electrically conductive.

- ▶ HDPE, black, anti-static
- ▶ With or without threaded connector 3/4"
- ▶ Canister support made of aluminium for secure stand as accessory (only for 5 l canister)

Compact jerrycan, electroconductive

Model	Capacity l	Width mm	Depth mm	Height mm	Item no.
without threaded connector	5	65	335	335	0435-1055 N4
without threaded connector	10	125	335	335	0435-1105 N4
with threaded connector 3/4"	5	65	335	335	0435-2055 N4
with threaded connector 3/4"	10	125	335	335	0435-2105 N4

Accessories

Description	Item no.
Anti-static set	5602-1000 N4

Accessories

Description	Item no.
StopCock PA, electroconductive	0525-1100 N4
Support stand for two compact jerrycans (only for 5 l canister)	0435-9102 N4
Support stand for three compact jerrycans (only for 5 l canister)	0435-9103 N4
Filling support for compact jerrycan 10 l	0435-9104 N4

Electrically conductive canister with UN approval

Canister made of electrically conductive HDPE for preventing ignition sources. The canisters are capable of diverting a charge (surface resistance $<10^9$ ohms) and can be earthed, which makes them suitable for use with flammable liquids.

- ▶ HDPE, capable of diverting a charge
- ▶ With carrying handle and screw cap
- ▶ With UN approval for transport (page 281)
- ▶ Stackable

⚠ Caution! When working with combustible liquids, the canister must be earthed! Use anti-static set!



Electrically conductive canister with UN approval

Capacity l	L x W x H mm	UN approval	Thread	Weight g	Item no.
10	300 x 200 x 258	3H1/Y1.5/200	DIN 61	770	1428-0010 N4
20	300 x 200 x 495	3H1/Y1.5/150	DIN 61	1320	1428-0020 N4
30	364 x 240 x 455	3H1/Y1.5/150	DIN 61	1350	1428-0030 N4



Jerrycans



Screw lid with drain cock on jerrycan, accessory

Canister for storage or transport. Canister with UN transport approval and tamper-evident seal.

- ▶ HDPE
- ▶ With UN approval for transport (page 281)
- ▶ Screw lid with drain cock available as accessory

Bulk prices

Jerrycans

Capacity l	L x W x H mm	Weight g	Neck dia. inside mm	Thread	Colour	UN approval	Item no.
2.5	153 x 115 x 208	125	34.8	DIN45	transparent	3H1/Y1.6/150	1427-0002 N3
5	190 x 145 x 251	250	40.5	DIN50	transparent	3H1/X1.9/250	1427-0005 N3
10	230 x 190 x 310	450	40.5	DIN50	transparent	3H1/X1.9/250	1427-0010 N3
20	290 x 246 x 385	950	48.5	DIN60	blue	3H1/X1.9/250	1427-0020 N3
30	320 x 284 x 435	1250	48.5	DIN60	blue	3H1/X1.9/250	1427-0030 N3



Accessories

Description	Item no.
Screw closure DIN45 with spigot for jerrycans	1427-9101 N3
Screw closure DIN50 with spigot for jerrycans	1427-9102 N3
Screw closure DIN60 with spigot for jerrycans	1427-9100 N3
Original screw cap DIN45	1427-9107 N3
Original screw cap DIN50	1427-9105 N3
Original screw cap DIN60	1427-9106 N3

Wide-necked jerrycans with/without threaded connector

Wide-necked canister with extremely wide filling opening (88 mm), easy to clean on the inside, which is particularly important when storing sensitive substances. Carrying handles and screw lid guarantee safe and convenient transport. The wide-necked canister can also be used as a settling canister. Via a threaded connector just above the base, a spigot or other accessories with an inner thread of 3/4" can be attached.

- ▶ HDPE, transparent
- ▶ UV stabilised
- ▶ Self-adhesive blue litre graduation and spigots available as accessory



Wide-necked jerrycans with/without threaded connector

Model	Capacity l	Width mm	Depth mm	Height mm	Ventilation dia. mm	Item no.
without threaded connector	5	130	290	280	18	0431-0005 N3
without threaded connector	10	137	310	400	18	0431-0010 N3
without threaded connector	20	165	365	485	-	0431-0020 N3
without threaded connector	30	240	365	485	-	0431-0030 N3
with threaded connector 3/4"	5	130	290	280	18	0431-1005 N3
with threaded connector 3/4"	10	137	310	400	18	0431-1010 N3
with threaded connector 3/4"	20	165	365	485	-	0431-1020 N3
with threaded connector 3/4"	30	240	365	485	-	0431-1030 N3



Accessories

Description	Item no.
Graduation for wide-necked jerrycans 5 l	0431-9051 N3
Graduation for wide-necked jerrycans 10 l	0431-9011 N3
Graduation for wide-necked jerrycans 20 l	0431-9021 N3
Graduation for wide-necked jerrycans 30 l	0431-9031 N3
StopCock angled (see page 40)	0525-1000 N4
Compact spigot (see page 41)	0530-1000 N4
Closure cap 3/4"	0600-0090 N4

Storage bottles, with/without threaded connector

Robust storage bottle with particularly thick sides with sturdy carrying handle for safe transport and storage. Blue litre graduation printed on. The venting valve (accessory) lets air into the container in order to prevent a vacuum in the bottle. The canister can also be used as a settling canister. Via a threaded connector, a spigot or other accessories with an inner thread/cap nut of 3/4" can be attached.

- ▶ HDPE
- ▶ Bottle opening diameter 50 mm



Storage bottles, with/without threaded connector

Model	Capacity l	Container dia. mm	Height capless mm	Handles	Item no.
without threaded connector	5	167	330	1	0401-0005 N3
without threaded connector	10	206	427	1	0401-0010 N3
without threaded connector	25	278	580	2	0401-0025 N3
without threaded connector	60	346	830	2	0401-0060 N3
with threaded connector	5	167	330	1	0402-0005 N3
with threaded connector	10	206	427	1	0402-0010 N3
with threaded connector	25	278	580	2	0402-0025 N3
with threaded connector	60	346	830	2	0402-0060 N3

Accessories

Description	Item no.
Ventilation seal for storage bottles	0401-9100 N3
① StopCock angled (see page 40)	0525-1000 N4
② Compact spigot (see page 41)	0530-1000 N4

Universal storage containers



Practical storage containers with closed gripping edges for safe transport of pourable or liquid contents. Rounded inner edges and smooth inner surfaces for easy cleaning enable use in the foodstuffs/hygiene sector.

- ▶ HDPE, white
- ▶ Can be stacked

! Attention! Make sure to pay attention to the "List of Chemical Resistance"!

Universal storage containers			
Capacity l	Outer dimension of rim L x W x H mm	Inner dimension L x W x H mm	Item no.
29	660 x 450 x 130	600 x 400 x 120	3418-0129 N2
48	660 x 450 x 220	600 x 400 x 210	3418-0148 N2
94	660 x 450 x 410	600 x 400 x 400	3418-0194 N2

Accessories	
Description	Item no.
Lid for universal storage containers, PS white	3418-0001 N2

Storage and stacking containers



Lids for storage and stacking containers

Stable storage containers made of durable PP with external reinforcement ribs.

- ▶ Temperature resistant from -40 °C to +90 °C
- ▶ According to Euro standards
- ▶ Lid and transport rollers available as accessory



Transport roller

Storage and stacking containers

Capacity l	Outer dimension of rim L x W x H mm	Inner dimension L x W x H mm	Item no.
11	400 x 300 x 120	367 x 267 x 116	3414-0111 N2
17	400 x 300 x 180	367 x 267 x 176	3414-0117 N2
23	400 x 300 x 220	367 x 267 x 216	3414-0120 N2
23	600 x 400 x 120	567 x 367 x 114	3414-0123 N2
38	600 x 400 x 180	567 x 367 x 176	3414-0138 N2
45	600 x 400 x 220	567 x 367 x 216	3414-0148 N2
64	600 x 400 x 320	567 x 367 x 316	3414-0164 N2
80	600 x 400 x 420	567 x 367 x 416	3414-0181 N2

Accessories

Description	Item no.
Lid for storage/stacking containers 400 x 300 mm	3414-0001 N2
Lid for storage/stacking containers 600 x 400 mm	3414-0002 N2

Transport trolley for containers

Model	Item no.
for 600 x 400 mm	3414-9900 N2

Disposal kegs, wide-mouth containers



Wide-necked container for disposal or storage of powders, granulates and liquids. Can be closed tightly and sealed. The containers have an UN transport approval for solids.

- ▶ HDPE
- ▶ Temperature resistant from -20 °C to +80 °C
- ▶ UN transport approval for solids 1H2/X (page 281)
- ▶ Seal made of natural rubber

Disposal kegs, wide-mouth containers



Capacity l	Container dia. mm	Height with cap mm	Opening dia. mm	Item no.
3,6	198	171	136	1105-0003 N3
6	198	263	136	1105-0006 N3
10	274	238	203	1105-0010 N3
26	316	425	203	1105-0026 N3
34	338	449	295	1105-0033 N3

Accessories

Description	Item no.
SampleSafe seal, red, 100 pieces	5399-2902 N4

Wide-mouth containers with handle



Container with 2.3 l and 4.4 l contents and particularly wide opening. Therefore ideal for filling with bulk goods of all kinds. Products such as spices, tea, granulates can be packaged, stored or displayed as samples in these containers. Space-saving square shape.

- ▶ Safe handling with integral handle
- ▶ Transparent polyethylene provides good view of contents.
- ▶ 0317-2300 with tamper-evident screw cap made of blue PP, 0317-4400 with screw cap made of LDPE

Wide-mouth containers with handle



Capacity ml	L x W mm	Height with cap mm	Neck dia. inside mm	Thread dia. mm	Item no.
2300	135 x 135	192	68.5	80	0317-2300 N3
4400	142 x 142	263	109	120	0317-4400 N3

Wide-mouth containers, HDPE



Storage or transport container made of HDPE. For liquids, powders or granules.

Keep the container upright when transporting liquids!

Wide-mouth containers, HDPE

Capacity l	Container dia. mm	Height with cap mm	Opening dia. mm	Item no.
5	192	250	110	1406-1005 N3
10	232	325	110	1406-1010 N3

Tubs, round



Tub for every purpose, with strong edge and practical carrying handles for safe transport. A lid can be delivered for every tub.

- ▶ Tub made of HDPE
- ▶ Temperature resistant from -30 °C to +70 °C
- ▶ Suitable for food
- ▶ High degree of chemical resistance

Attention! Make sure to pay attention to the "List of Chemical Resistance"!

Tubs, round

Capacity l	Dia. top/below x H mm	Item no.
40	370/330 x 440	3482-0040 N3
50	370/330 x 555	3482-0050 N3
75	460/400 x 535	3482-0075 N3
110	460/420 x 710	3482-0110 N3

Accessories

Description	Item no.
Lids for tubs, round, for 370 mm dia.	3482-0401 N3
Lids for tubs, round, for 460 mm dia.	3482-0751 N3

Mixing/dosing container



The containers close completely tight. They have thick sides, they are seamless, impact resistant and stressfree sintered. The wide-necked opening enables safe filling.

- ▶ LDPE
- ▶ With 3/4" inner thread at the container base
- ▶ Suitable for food

Note the "List of Chemical Resistance"!

Mixing/dosing container

Capacity l	Dia. mm	Height mm	Opening dia. mm	Division l	Item no.
60	450	620	132	10	3460-0060 N2
100	450	800	160	10	3460-0100 N2
200	550	1020	155	20	3460-0200 N2
500	815	1230	160	50	3460-0500 N2

Containers, rectangular and round shaped



Container for various applications. Produced seamlessly and stress-relieved with the LaboPlast® sintering method. The wall thickness increases downwardly. This guarantees optimum ratio of wall thickness to filling load. The containers are also colored black for UV-protection and are available in other wall thicknesses. Custom-made, exchange excluded.

- ▶ L-LDPE (linear LDPE), transparent
- ▶ Rupture-proof

We will mount the container connector directly into the container for you. The thread connectors are possible anywhere. Please state the exact position on the container, if applicable.

Container thread

Model	Thread	Item no.
Container thread	3/4"	3440-0034 N2

Accessories

Description	Item no.
StopCock angled (see page 40)	0525-1000 N4
Compact spigot (see page 41)	0530-1000 N4

Containers, rectangular

Capacity l	Inner dimension L x W x H mm	Wall thickness mm	Item no.	
13	220 x 220 x 410	5	3440-0135	N2
23	540 x 370 x 130	5	3440-0235	N2
40	390 x 190 x 620	5	3440-0405	N2
45	600 x 600 x 165	5	3440-0455	N2
48	400 x 400 x 300	5	3440-0485	N2
50	1000 x 320 x 160	5	3440-0505	N2
56	315 x 315 x 635	5	3440-0565	N2
70	460 x 310 x 570	5	3440-0705	N2
85	600 x 340 x 480	5	3440-0855	N2
90	600 x 400 x 410	6	3440-0906	N2
100	780 x 460 x 320	6	3440-1006	N2
115	500 x 400 x 600	6	3440-1156	N2
118	600 x 250 x 820	6	3440-1186	N2
130	710 x 330 x 560	6	3440-1306	N2
150	600 x 400 x 630	6	3440-1506	N2
155	600 x 500 x 560	6	3440-1556	N2
165	780 x 500 x 420	6	3440-1656	N2
190	600 x 400 x 800	6	3440-1906	N2
250	1000 x 600 x 450	6	3440-2506	N2
260	800 x 600 x 600	7	3440-2607	N2
285	600 x 600 x 820	7	3440-2857	N2
320	1000 x 400 x 800	7	3440-3207	N2
400	860 x 560 x 840	7	3440-4007	N2

Containers, round shaped

Capacity l	Inner dia. mm	Height mm	Wall thickness mm	Item no.	
14	245	325	5	3490-0144	N2
25	310	390	5	3490-0254	N2
30	310	430	5	3490-0305	N2
35	320	530	5	3490-0355	N2
50	410	480	5	3490-0505	N2
55	310	915	5	3490-0555	N2
60	410	530	5	3490-0605	N2
80	430	590	5	3490-0805	N2
85	390	710	5	3490-0855	N2
100	470	680	5	3490-1005	N2
110	540	540	6	3490-1106	N2
120	470	720	6	3490-1206	N2
145	600	510	6	3490-1456	N2
150	550	730	6	3490-1506	N2
160	460	1020	6	3490-1606	N2
180	540	820	6	3490-1806	N2
200	560	840	6	3490-2006	N2
205	800	440	6	3490-2056	N2
210	540	950	6	3490-2106	N2
250	550	1040	6	3490-2506	N2
290	740	770	6	3490-2906	N2
300	690	830	6	3490-3006	N2
400	760	1050	6	3490-4006	N2
850	970	1170	7	3490-8507	N2

Lid for containers, rectangular

Model	Item no.	
for 13 l container	3440-0131	N2
for 23 l container	3440-0231	N2
for 40 l container	3440-0401	N2
for 45 l container	3440-0451	N2
for 48 l container	3440-0481	N2
for 50 l container	3440-0501	N2
for 56 l container	3440-0561	N2
for 70 l container	3440-0701	N2
for 85 l container	3440-0851	N2
for 90 l container	3440-0901	N2
for 100 l container	3440-1001	N2
for 118 l container	3440-1181	N2
for 130 l container	3440-1301	N2
for 150 l container	3440-1501	N2
for 155 l container	3440-1551	N2
for 165 l container	3440-1651	N2
for 190 l container	3440-1901	N2
for 250 l container	3440-2501	N2
for 260 l container	3440-2601	N2
for 285 l container	3440-2851	N2
for 320 l container	3440-3201	N2
for 400 l container	3440-4001	N2

Lid for containers, round shaped

Model	Item no.	
for 14 l container	3490-0141	N2
for 25 l container	3490-0251	N2
for 30 l container	3490-0301	N2
for 35 l container	3490-0351	N2
for 50 l container	3490-0501	N2
for 55 l container	3490-0551	N2
for 60 l container	3490-0601	N2
for 80 l container	3490-0801	N2
for 85 l container	3490-0851	N2
for 100 l container	3490-1001	N2
for 110 l container	3490-1101	N2
for 120 l container	3490-1201	N2
for 145 l container	3490-1451	N2
for 150 l container	3490-1501	N2
for 160 l container	3490-1601	N2
for 180 l container	3490-1801	N2
for 200 l container	3490-2001	N2
for 205 l container	3490-2051	N2
for 210 l container	3490-2101	N2
for 250 l container	3490-2501	N2
for 290 l container	3490-2901	N2
for 300 l container	3490-3001	N2
for 400 l container	3490-4001	N2
for 850 l container	3490-8501	N2

Safety jerrycans stainless steel



- ▶ 0.8 mm sides
- ▶ Handles made of solid stainless steel
- ▶ Closure thread 1 1/2"
- ▶ Seals made of PTFE
- ▶ Accredited for UN-transports according to ADR, RID, IMDG Code, ICAO-TI, GGVSEB, GGVSee

Safety canister for transport and storage made of stainless steel AISI 316 Ti (1.4571) for 5 l and 10 l canisters and AISI 304 (1.4301) for 20 l canisters. Protection from exploding through flame protection and excess pressure valve. The containers have a high degree of chemical resistance and they save space. In canisters with excess pressure valve, pressure balance takes place from about 0.3 bar. Safety canister with self-closing fine dosage spout 20 l: with separate ventilation. Canisters with a venting screw enable manual air supply when used or manual pressure balance during storage.

Safety cans stainless steel



- ▶ Stainless steel AISI 316 Ti (1.4571), 0.6 mm thickness
- ▶ Seals made of PTFE
- ▶ Handle made of powder-surfaced aluminium
- ▶ Closure thread 1 1/4"

For safe metering and handling of smaller amounts of flammable liquids. Protection from exploding through flame protection and excess pressure valve, the containers have a high degree of chemical resistance. Can with removable flame protection in the filling connector and excess pressure valve in the self-closing fine dosage spout (pressure balance from about 0.3 bar).

Safety jerrycans stainless steel

Model	Capacity l	Purpose	L x W x H mm	UN approval	Item no.
with screw cap without pressure-relief valve	10	transport	280 x 130 x 380	3A1/X1.6/300	2601-7010 N2
with screw cap and pressure-relief valve	5	storage	200 x 130 x 310	no	2601-3005 N2
with screw cap and pressure-relief valve	10	storage	280 x 130 x 380	no	2601-3010 N2
with screw cap and pressure-relief valve	20	storage	345 x 175 x 470	no	2601-3020 N2
with fine dosage spout incl. pressure-relief valve	10	storage/transfer	280 x 130 x 380	no	2601-2010 N2
with fine dosage spout, pressure-relief valve, ventilation screw	20	storage/transfer	345 x 175 x 470	no	2601-2020 N2

Safety cans stainless steel

Capacity l	Dia. mm	Height mm	Purpose	UN approval	Item no.
1	111	235	storage/transfer	no	2601-1001 N2
2	131	295	storage/transfer	no	2601-1002 N2
5	165	400	storage/transfer	no	2601-1005 N2

Safety storage container stainless steel

Safety containers for transport and storage made of high-quality stainless steel AISI 304 (1.4301) / AISI 316 Ti (1.4571) with thickness of sides of 0.8 mm (10 l), 1.2 mm (25 l) and 1.5 mm (50 l). The 25 l container can be stacked.

Protection from exploding through flame protection and excess pressure valve, seals made of PTFE, the containers have a high degree of chemical resistance.

In safety containers with excess pressure valve, pressure balance takes place from about 0.3 bar.

For containers with self-closing tap, constant ventilation can be set via a plastic lever on the screw cap.

The contents display made of perfluoroalkoxy copolymers (PFA) enables a visual contents check when filling and emptying.

► Accredited for UN-transports according to ADR, RID, IMDG Code, ICAO-TI, GGVSEB, GGVSee



Safety storage container stainless steel

Model	Capacity l	Purpose	Height mm	Thread	Dia. mm	UN approval	Thread, outflowing side	Item no.	
① with screw cap, without pressure-relief valve	25	transport/storage	530	1 1/2"	300	1A1/X1.6/400	-	2601-5125	N2
② with screw cap and pressure-relief valve	50	storage	600	G 2"	365	no	-	2601-5050	N2
③ with tab and pressure-relief valve	10	storage/transfer	330	1 1/2"	260	no	3/4"	2601-4010	N2
④ with tab and pressure-relief valve	25	storage/transfer	540	1 1/2"	315	no	3/4"	2601-4025	N2
⑤ with tab, pressure-relief valve and level indicator	10	storage/transfer	330	1 1/2"	260	no	3/4"	2601-6010	N2

2 weeks

Packaging bucket



Packaging bucket for transport, packaging and storing of various materials. Suitable for the food or building material industries and non-aggressive chemicals in environmental protection, hospitals and the household. With strong handle. Quality closure on the bucket for product safety.

- ▶ PP, white
- ▶ Air-tight closure
- ▶ Complete with lid
- ▶ With advertising printing in large quantities on request

Bulk prices

Packaging bucket

Capacity l	Dia. top mm	Height with cap mm	Item no.			
1	132	131	2327-0001 N3			
2	175	132	2327-0020 N3			
3	225	123	2327-0030 N3			
5	225	194	2327-0050 N3			
10	268	263	2327-0010 N3			

Packaging bags with closure



Bags with the "zipper" closure for storing, collecting, protecting and shipping of specimens, samples and sales products. Contents remain dust-free. The film is waterproof and has good tear resistance.

- ▶ LDPE, crystal-clear
- ▶ 0.05 mm strong film

Bulk prices

Packaging bags with closure

L x W mm	Volume ml	Pieces per pack	Item no.			
100 x 70	80	100	2348-0002 N3			
130 x 60	100	100	2348-0001 N3			
120 x 80	140	100	2348-0003 N3			
150 x 100	300	100	2348-0004 N3			
170 x 120	400	100	2348-0005 N3			
220 x 160	1000	100	2348-0006 N3			
250 x 180	1500	100	2348-0007 N3			
300 x 200	2500	100	2348-0008 N3			
350 x 250	4500	100	2348-0009 N3			
400 x 300	6500	100	2348-0010 N3			

Sampling bag SteriBag

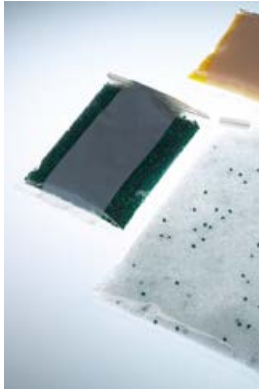

Sampling bag SteriBag for chemistry, pharmaceuticals, medicine, veterinary science and food-stuffs etc.

*** Page 120**



SteriBag StandUp is a sterile sample bag with a stand-up base.







SteriBag Cleanroom can be placed directly in the clean room.



SteriBag Blue is especially well suited for use in the food, animal feed and pharmaceutical industries.







SteriBag Premium uniquely combines a high degree of security, sterility, tamper evident closure and traceability.

Sampling bag SteriBag    





Capacity ml	Model	L x W mm	Pieces per pack	Item no.
60	without labelling area	127 x 76	500	5344-0060 N3
60	with labelling area	127 x 76	500	5344-0061 N3
150	without labelling area	178 x 76	500	5344-0180 N3
150	with labelling area	178 x 76	500	5344-0181 N3
450	without labelling area	229 x 114	500	5344-0540 N3
450	with labelling area	229 x 114	500	5344-0541 N3
650	without labelling area	229 x 140	500	5344-0720 N3
650	with labelling area	229 x 140	500	5344-0721 N3
800	without labelling area	305 x 114	500	5344-0810 N3
800	with labelling area	305 x 114	500	5344-0811 N3
1650	without labelling area	305 x 178	250	5344-1650 N3
1650	with labelling area	305 x 178	250	5344-1651 N3

*** Page 121**

SteriBag StandUp sample bag    





Capacity ml	L x W mm	Pieces per pack	Item no.
400	229 x 114	250	5344-0400 N3
600	229 x 152	250	5344-0600 N3

*** Page 122**

Sampling bag SteriBag Cleanroom    





Capacity ml	L x W mm	Pieces per pack	Item no.
800	305 x 114	500	5344-8010 N3
1650	305 x 178	250	5344-8012 N3

*** Page 121**

Sampling bag SteriBag Blue    

Capacity ml	L x W mm	Pieces per pack	Item no.
650	229 x 140	500	5344-7008 N3
1650	305 x 178	250	5344-7012 N3

*** Page 122**

SteriBag Premium tamper-proof sample bag    

Capacity ml	L x W mm	Pieces per pack	Item no.
300	200x145	100	5344-8000 N4

Table of contents industrial & laboratory equipment



214 – 220 Trays, servers

213 – 223 Bowls, buckets

224 – 227 Funnels, funnel stands

228 – 233 Graduated beakers, graduated cylinders, measuring jugs

234 – 235 Titrating burettes

236 – 239 Pipettes, pipetting accessories, pipette stand

240 – 241 Draining & test-tube racks

242 SnowPack® dry ice machine

243 – 253 Tubings, connectors, flow indicators

254 – 259 Hose clamps, two-way and three-way valves, non-return valves

260 – 269 Hose couplings, threaded fittings

270 – 272 Vacuum pumps, water-jet pumps, dessicator

272 – 274 Protective equipment

275 – 277 Bungs, stirring, mixing





Industrial & laboratory equipment

Connectors, fittings, funnels, measuring

All-purpose trays | hygienic, easy to clean



The laboratory trays are practical all-purpose trays that can be nested when empty, also durable, shatter-proof and resist flexing. The trays have a strong, rounded rim.

Suitable as a spill trough for environmentally dangerous, aggressive substances, for experiments, as an etching tray, as an instrument holder, a medicine tray, a photographic development basin, a goods presentation tray and a display tray for foodstuffs.

- ▶ PP, white
- ▶ Manufactured using the injection moulding process, not by deep drawing
- ▶ Trays can be nested
- ▶ Tray not suitable for temperature controlled cupboards or dishwashers
- ▶ Temperature resistant up to +60 °C (briefly up to +80 °C)



Laboratory trays / spill troughs separate

Capacity l	Inner dimension of base L x W mm	Outer dimension of base L x W mm	Outer dimension of rim L x W x H mm	Item no.
0.5	130 x 180	140 x 190	180 x 230 x 42	4201-1318 N4
1.5	180 x 240	190 x 250	250 x 310 x 65	4201-1824 N4
3.0	240 x 300	250 x 310	310 x 370 x 75	4201-2430 N4
10	300 x 400	310 x 410	420 x 520 x 120	4201-3040 N4
21	400 x 500	430 x 530	534 x 634 x 140	4201-4050 N4
39	500 x 700	520 x 720	648 x 846 x 160	4201-5070 N4

Accessories

Description	Item no.
Laboratory trays / spill troughs set - 4 piece set	4201-0095 N4
Laboratory trays / spill troughs set - 6 piece set	4201-0100 N4

Laboratory trays / spill troughs set

Laboratory trays/Spill troughs in a beneficial set

Laboratory tray set of 4 with one tray each:

- ▶ 0.5 l (L x W x H 180 x 230 x 42 mm)
- ▶ 1.5 l (L x W x H 250 x 310 x 65 mm)
- ▶ 3.0 l (L x W x H 310 x 370 x 75 mm)
- ▶ 10.0 l (L x W x H 420 x 520 x 120 mm)

Laboratory tray set of 6 with one tray each:

- ▶ 0.5 l (L x W x H 180 x 230 x 42 mm)
- ▶ 1.5 l (L x W x H 250 x 310 x 65 mm)
- ▶ 3.0 l (L x W x H 310 x 370 x 75 mm)
- ▶ 10.0 l (L x W x H 420 x 520 x 120 mm)
- ▶ 21.0 l (L x W x H 534 x 634 x 140 mm)
- ▶ 39.0 l (L x W x H 648 x 846 x 160 mm)



Laboratory trays / spill troughs set

Model	Capacity l	Item no.
4 piece set	0.5 – 10	4201-0095 N4
6 piece set	0.5 – 39	4201-0100 N4



Photographic trays | in a variety of colours and sizes



These photographic trays made of PVC are available in a variety of shapes and colours. Available in shallow or deep models, with or without ribs on the base, in 3 attractive, high-gloss colours: white, red and black. The model with ribs on the base is especially well suited as a film development tray. The raised ribs prevent photographic paper from sticking to the base of the tray. Liquid can be poured out easily from the tray edges. The model without ribs on the base is suited for universal laboratory or storage purposes. Important: the photographic trays are made of high-quality PVC.



- ▶ PVC
- ▶ Thick sides, shatterproof
- ▶ Largely resistant to acids and alkalis
- ▶ Not suitable for temperature controlled cupboards or dishwashers
- ▶ Temperature resistant from -30 °C up to +60 °C max.

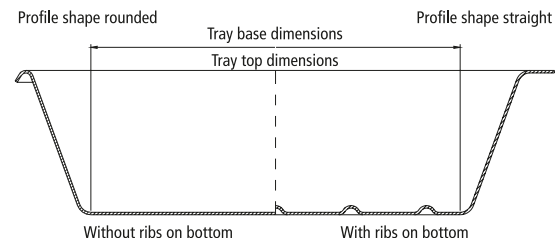

Photographic trays | in a variety of colours and sizes

Photographic trays, shallow form with ribs on bottom, profile shape rounded					
Colour	Inner dimension of base L x W mm	Outer dimension of rim L x W mm	Height mm	Item no.	
white	140 x 190	180 x 230	40	4202-1013	N4
white	190 x 260	240 x 320	50	4202-1018	N4
white	260 x 320	320 x 370	50	4202-1024	N4
white	310 x 410	370 x 470	60	4202-1030	N4
white	420 x 510	480 x 580	60	4202-1040	N4
white	510 x 610	590 x 680	70	4202-1050	N4
red	140 x 190	180 x 230	40	4202-2013	N4
red	190 x 260	240 x 320	50	4202-2018	N4
red	260 x 320	320 x 370	50	4202-2024	N4
red	420 x 510	480 x 580	60	4202-2040	N4
red	510 x 610	590 x 680	70	4202-2050	N4
black	190 x 260	240 x 320	50	4202-3018	N4
black	260 x 320	320 x 370	50	4202-3024	N4

Photographic trays, deep form with ribs on bottom					
Colour	Inner dimension of base L x W mm	Outer dimension of rim L x W mm	Height mm	Profile shape	Item no.
white	310 x 410	430 x 530	105	straight	4206-1030 N4
white	420 x 510	520 x 610	110	straight	4206-1040 N4
white	510 x 610	630 x 730	110	straight	4206-1050 N4
red	310 x 410	430 x 530	105	straight	4206-2030 N4
red	420 x 510	520 x 610	110	straight	4206-2040 N4
black	420 x 510	520 x 610	110	straight	4206-3040 N4
black	510 x 610	630 x 730	110	straight	4206-3050 N4

Photographic trays, shallow form without ribs on bottom, profile shape rounded					
Colour	Inner dimension of base L x W mm	Outer dimension of rim L x W mm	Height mm	Item no.	
white	110 x 160	150 x 200	30	4203-1010	N4
white	140 x 190	180 x 230	40	4203-1013	N4
white	190 x 260	240 x 320	50	4203-1018	N4
white	260 x 320	320 x 370	50	4203-1024	N4
white	310 x 410	370 x 470	60	4203-1030	N4
white	420 x 510	480 x 580	60	4203-1040	N4
white	510 x 610	590 x 680	70	4203-1050	N4
red	110 x 160	150 x 200	30	4203-2010	N4
red	140 x 190	180 x 230	40	4203-2013	N4
red	190 x 260	240 x 320	50	4203-2018	N4
red	260 x 320	320 x 370	50	4203-2024	N4
red	310 x 410	370 x 470	60	4203-2030	N4
red	510 x 610	590 x 680	70	4203-2050	N4
black	110 x 160	150 x 200	30	4203-3010	N4
black	140 x 190	180 x 230	40	4203-3013	N4
black	190 x 260	240 x 320	50	4203-3018	N4
black	260 x 320	320 x 370	50	4203-3024	N4
black	310 x 410	370 x 470	60	4203-3030	N4
black	510 x 610	590 x 680	70	4203-3050	N4

Photographic trays, deep form without ribs on bottom					
Colour	Inner dimension of base L x W mm	Outer dimension of rim L x W mm	Height mm	Profile shape	Item no.
white	190 x 260	260 x 340	85	rounded	4207-1018 N4
white	260 x 320	330 x 390	100	rounded	4207-1024 N4
white	310 x 410	430 x 530	105	straight	4207-1030 N4
white	420 x 510	520 x 610	110	straight	4207-1040 N4
white	510 x 610	630 x 730	110	straight	4207-1050 N4
red	190 x 260	260 x 340	85	rounded	4207-2018 N4
red	260 x 320	330 x 390	100	rounded	4207-2024 N4
red	310 x 410	430 x 530	105	straight	4207-2030 N4
red	420 x 510	520 x 610	110	straight	4207-2040 N4
red	510 x 610	630 x 730	110	straight	4207-2050 N4
black	310 x 410	430 x 530	105	straight	4207-3030 N4
black	420 x 510	520 x 610	110	straight	4207-3040 N4
black	510 x 610	630 x 730	110	straight	4207-3050 N4

Bowl stainless steel, shallow form



The robust stainless steel bowl is ideal for cleaning, disinfecting or sterilising instruments as well as for placing and carrying different devices or samples. Due to the smooth surface, the instrument tray is easy to clean.

The rectangular bowl has a low edge and can be used in the various areas of pharmacy, chemistry, cosmetics and food.

- ▶ For cleaning, disinfecting, sterilising or placing away laboratory cutlery
- ▶ Stable and hygienic

Bowl stainless steel, shallow form

L x W x H mm	Item no.	 
200 x 150 x 50	4208-0020 N4	
280 x 180 x 50	4208-0021 N4	
300 x 200 x 50	4208-0022 N4	
300 x 250 x 50	4208-0023 N4	
400 x 300 x 50	4208-0024 N4	
500 x 300 x 50	4208-0025 N4	



Bowl stainless steel, deep form



The stainless steel bowl is suitable for a wide variety of applications, e.g. for storing, carrying or cleaning laboratory cutlery or samplers. The smooth surface of the tray makes it easy to clean. The instrument tray has a rectangular shape with a high edge and is very stable. Ideal for use in the pharmaceutical and chemical sectors as well as the food and cosmetics sectors.

- ▶ For placing, transporting or cleaning instruments
- ▶ Robust and hygienic

Bowl stainless steel, deep form

L x W x H mm	Item no.	 
400 x 200 x 100	4208-0040 N4	
400 x 300 x 100	4208-0041 N4	
500 x 300 x 100	4208-0042 N4	

Instrument trays



Trays for various uses: in laboratories, doctors' surgeries, hospitals, pharmacies, the foodstuffs industry – wherever there is a need for clean storage of instruments, equipment, goods and precision parts.

- ▶ Melamine, white
- ▶ Tray without lid, autoclavable
- ▶ Lid available as accessory

Instrument trays

Capacity ml	L x W x H mm	Item no.	autoclave 121°	CJW YY
500	210 x 110 x 35	4230-2050 N3		
700	190 x 150 x 40	4230-2070 N3		
1000	290 x 160 x 35	4230-2100 N3		
1800	290 x 160 x 60	4230-2180 N3		
2300	350 x 250 x 40	4230-2230 N3		
5500	350 x 250 x 100	4230-2550 N3		

Accessories

Description	Item no.
Lids for instrument trays 500 ml, PS crystal clear	4230-2051 N3
Lids for instrument trays 700 ml, PS crystal clear	4230-2071 N3
Lids for instrument trays 1000/1800 ml, PS crystal clear	4230-2101 N3
Lids for instrument trays 2300/5500 ml, PS crystal clear	4230-2231 N3

Bowls sterilisable



Particularly stable bowl, with wide holding edge, can be stacked, substances which solidify in the bowl can easily be removed.

- ▶ PP, white
- ▶ Sterilisable up to +121 °C

Bowls sterilisable

Capacity l	Dia. mm	Height mm	Item no.	autoclave 121°	CJW YY
0.9	160	70	4702-0008 N3		
1.7	200	80	4702-0017 N3		
2.9	240	100	4702-0028 N3		
4.3	280	120	4702-0045 N3		
6.6	320	130	4702-0065 N3		
13.4	400	180	4702-0013 N3		

Tray stainless steel



Instruments, labware or samplers can be placed and transported on the sturdy stainless steel tray. The smooth surface is easy to clean. The rectangular instrument tray is suitable for hygienic placing in the fields of chemistry, pharmaceuticals, cosmetics, animal feed and food & beverage.

- ▶ Prepare, place and carry instruments and samples
- ▶ Hygienic and robust

Tray stainless steel

L x W x H mm	Item no.
280 x 180 x 20	4208-0001 N4
330 x 230 x 20	4208-0002 N4
460 x 300 x 20	4208-0003 N4
520 x 395 x 20	4208-0004 N4

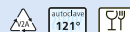

Instrument servers



Servers for various uses – wherever there is a need for clean storage of instruments, equipment, goods and precision parts.

- ▶ Melamine, white

Instrument servers

L x W x H mm	Item no.
190 x 150 x 17	4230-3019 N3
240 x 180 x 17	4230-3024 N3
268 x 208 x 17	4230-3027 N3
355 x 240 x 17	4230-3036 N3
428 x 288 x 17	4230-3043 N3



Bucket, stainless steel



The bucket is made entirely of high-gloss polished stainless steel. The smooth surface of the stainless steel bucket makes it easy to clean. The rounded, movable handle makes it comfortable to move the bucket. The laboratory bucket is suitable for moving liquids and bulk materials properly, especially in the chemical, pharmaceutical or cosmetic industries, and in the food and animal feed industries.

- ▶ Stainless steel (1.4301)
- ▶ High-gloss polished

Bucket, stainless steel

Capacity l	Dia. mm	Height mm	Item no.
10	275	275	2309-0010 N4
15	330	305	2309-0015 N4



Packaging bucket



Packaging bucket for transport, packaging and storing of various materials. Suitable for the food or building material industries and non-aggressive chemicals in environmental protection, hospitals and the household. With strong handle. Quality closure on the bucket for product safety.

- ▶ PP, white
- ▶ Air-tight closure
- ▶ Complete with lid
- ▶ With advertising printing in large quantities on request

*** Bulk prices**

Packaging bucket

Capacity l	Dia. top mm	Height with cap mm	Item no.
1	132	131	2327-0001 N3
2	175	132	2327-0020 N3
3	225	123	2327-0030 N3
5	225	194	2327-0050 N3
10	268	263	2327-0010 N3



Industrial bucket with metal handle



Industrial bucket for transporting, decanting and mixing. Safe emptying with wide spout. Handle made of metal.

- ▶ LLDPE, white
- ▶ With litre scale, graduation 1000 ml
- ▶ With spout

Industrial bucket with metal handle



Capacity l	Dia. mm	Height mm	Item no.
9	280	250	2308-0900 N3
12	300	280	2308-1200 N3
17	340	310	2308-1700 N3

Laboratory bucket



Laboratory bucket for transporting, decanting and mixing. Safe emptying with wide spout. Handle made of metal.

- ▶ PE, white
- ▶ With contents scale, graduation 1000 ml
- ▶ With spout

Laboratory bucket



Capacity l	Dia. mm	Height mm	Item no.
10	290	280	2306-0010 N3
15	320	340	2306-0015 N3

Bucket HDPE



For transporting, decanting and mixing. Wide spout gives rapid but safe emptying. With plastic handle.

- ▶ HDPE, white or black
- ▶ With litre scale, graduation 1000 ml
- ▶ With spout
- ▶ Bucket HDPE black, not suitable for food

Bucket HDPE

Capacity l	Colour	Dia. mm	Height mm	Item no.	
10.5	black	286	289	2307-0010	N3
10.5	white	286	283	2307-0011	N3
17	black	330	315	2307-0017	N3
17	white	330	315	2307-0018	N3

Four-sided bucket



Bucket for transporting bulky goods. Saves space, sturdy, easy to carry, available with lid.

- ▶ PE, transparent
- ▶ Graduation 500 ml, up to 12 l
- ▶ With sturdy handle made of PE
- ▶ Contents right to the top 14 l

Four-sided bucket

Capacity l	L x W x H mm	Item no.	
14	280 x 280 x 290	2350-0140	N3
Accessories			
Description	Item no.		
Lid for four-sided bucket	2350-0141 N3		

Bucket made of PP



Bucket for transporting, decanting and mixing. Safe emptying with wide spout. Sturdy handle made of PP.

- ▶ PP, transparent
- ▶ With contents scale, graduation 1000 ml
- ▶ With spout
- ▶ Sterilisable

Bucket made of PP

Capacity l	Dia. mm	Height mm	Item no.	
12	310	330	2306-1012	N3
15	310	370	2306-1015	N3

Funnels | transparent, available in many different sizes

Powder funnels PP/PE



All-purpose funnels with suspension eyelet for safe filling of containers.

Powder funnel for safe filling of containers. 9606-0240 with fine sieve made of phosphor-bronze (not for use with foodstuffs).

General purpose funnels PP/PE

Outer dia. mm	Outlet dia. mm	Material	Item no.			
40	5	PP	9602-0040	N3		
60	8	PE	9602-0060	N3		
80	11	PE	9602-0080	N3		
100	10	PP	9602-0100	N3		
120	13	PP	9602-0120	N3		
140	16	PE	9602-0140	N3		
160	18	PE	9602-0160	N3		



Barrel funnels PP/PE

Outer dia. mm	Outlet dia. mm	Material	Item no.			
203	22	PP	9602-0200	N3		
260	23	PP	9602-0250	N3		
360	31	PP	9602-0350	N3		
400	42	PE	9602-0400	N3		
430	37	PE	9602-0450	N3		

Powder funnels PP/PE

Outer dia. mm	Outlet dia. mm	Material	Item no.			
80	21	PP	9606-0080	N3		
100	22	PP	9606-0100	N3		
150	28	PP	9606-0150	N3		
253	50	PE	9606-0240	N3		
360	65	PP	9606-0350	N3		

Accessories

Description	Item no.
Sieve for barrel funnels 203/260/360 mm	9602-0251 N3

Funnel, stainless steel



The stainless steel funnel can be used to pour and transfer free-flowing powders, liquids and slightly viscous media easily. An air channel on the discharge tube ensures a complete, unobstructed flow. Depending on the diameter, this pouring aid is suitable for dispensing applications, from small amounts in laboratories to large quantities in industry. Larger versions of the funnel feature a handle to ensure easy handling.

The sturdy stainless steel funnel can be used in a wide variety of applications.

- ▶ Stainless steel AISI 304 (1.4301)
- ▶ Air channel for unobstructed flow

Funnel, stainless steel			
Outer dia. mm	Outlet dia. mm	Item no.	
60	13	9604-0001	N4
100	13	9604-0003	N4
150	19	9604-0005	N4
300	20	9604-0008	N4

Disposable funnel for liquids/powders



Outer dia. mm	Outlet dia. mm	Pieces per pack	Item no.
①	Disposable funnel for liquids, see page 132		
100	10	10	5378-6001 N4
①	Disposable funnel for liquids, sterile, see page 132		
100	10	10	5378-6002 N4
②	Disposable powder funnel, see page 132		
100	25	10	5378-6005 N4
②	Disposable powder funnel, sterile, see page 132		
100	25	10	5378-6006 N4
③	Disposable funnel for liquids Bio, see page 137		
100	10	10	5379-0040 N4
③	Disposable funnel for liquids Bio, sterile, see page 137		
100	10	10	5379-1040 N4
④	Disposable powder funnel Bio, see page 137		
100	25	10	5379-0041 N4
④	Disposable powder funnel Bio, sterile, see page 137		
100	25	10	5379-1041 N4
⑤	Blue disposable funnels for liquids, see page 143		
100	10	10	5378-6003 N4
⑥	Blue disposable powder funnels, see page 143		
100	25	10	5378-6007 N4
⑦	Detectable funnels for liquids, see page 149		
100	10	10	5378-6004 N4
⑧	Detectable powder funnels, see page 149		
100	25	10	5378-6008 N4

Funnel stands

Sturdy and stable funnel stand, resistant to chemicals, shatter-proof and with continuously variable height adjustment.

The funnel stand is suitable for all funnels from 40 to 180 mm in diameter. The funnel holders can be used with reducing inserts for small funnels.

The funnel stand also makes an excellent filtering stand.

Thanks to an innovative magnet concept no clamping screws are necessary. The height of the funnel holder can be adjusted easily and flexibly with one hand.

The laboratory stand can be flexibly adapted with corresponding accessories, for example with adjustment funnel holders or a holder for Imhoff funnels (see page 227). The funnel stand can also be converted into a pipette stand (see page 239).

- ▶ PP, chrome-plated steel
- ▶ Continuously variable height adjustment with innovative magnet concept
- ▶ Adjustable height up to 450 mm
- ▶ For funnels Ø 40–180 mm
- ▶ Additional funnel holders are available as accessories



Funnel stand with two funnel holders and two reducing inserts. Space-saving design with two practical storage areas.



Funnel stand with four funnel holders and four reducing inserts. A very sturdy pedestal provides a storage area for four containers and ensures absolute safety against overturning.



Funnel stand for two funnels

Item no. 9622-0200 N4

Accessories

Description	Item no.
Funnel holder with reducing insert, for funnels Ø 40-180 mm	9622-0001 N4
Sedimentation funnel holder for Imhoff funnels from Ø 90 mm	7118-2001 N4

Funnel stand for four funnels

Item no. 9622-0400 N4

Accessories

Description	Item no.
Funnel holder with reducing insert, for funnels Ø 40-180 mm	9622-0001 N4
Sedimentation funnel holder for Imhoff funnels from Ø 90 mm	7118-2001 N4
Replacement set for pipette stand, two perforated plates/one drip pan	9630-0100 N4

Sedimentation funnel



① Stand for Imhoff sedimentation funnel

Item no.
7118-2000 N4

📦 Accessories

Description	Item no.
Funnel holder with reducing insert, for funnels Ø 40-180 mm	9622-0001 N4

② Sedimentation funnel

Model	Item no.
Funnel, single	7118-1000 N3

The stand for sedimentation funnels is used to keep, hold or store Imhoff funnels safely and reliably during sedimentation. Two funnel holders ensure that Imhoff funnels will be held safely and securely and can be placed in an absolutely vertical position.

Stand with two holders for sedimentation funnels, suitable for funnels 90 mm or more in diameter.

Thanks to an innovative magnet concept no clamping screws are necessary. The height of the funnel holder can be adjusted easily and flexibly with one hand. With the corresponding accessory the holders for Imhoff funnels can also be replaced by holders for all-purpose funnels (see page 226).

- ▶ Stand for Imhoff funnel
- ▶ PP, chrome-plated steel
- ▶ Adjustable height up to 450 mm
- ▶ For funnels with Ø 90 mm or more

Safety funnel



Safety funnel for filling containers easily. With overflow protection.

- ▶ Made of stainless steel AISI 304
- ▶ Flame block
- ▶ Connector 2" fine thread NPT
- ▶ Discharge pipe Ø 3.5 cm

Safety funnel stainless steel

Item no.	Item no.
2601-9900	N2

Graduated beakers with handle



Graduated beakers with handle, transparent graduation



Graduated beakers with handle, blue graduation



Graduated beakers made of PP are virtually indestructible and highly transparent.

Graduated beakers are perfectly suited as advertising means for chemical products. The smooth surface enables print of a logo or an advertising slogan.

- ▶ PP, transparent
- ▶ With indestructible graduation

Graduated beakers with handle, blue graduation



Capacity ml	Dia. top mm	Dia. bottom mm	Height mm	Item no.
100	50	40	80	7104-0100 N3
250	70	50	120	7104-0250 N3
500	91	75	140	7104-0500 N3
1000	116	95	181	7104-1000 N3
2000	150	125	213	7104-2000 N3
3000	170	120	242	7104-3000 N3
5000	210	160	270	7104-5000 N3

Graduated beakers with handle, transparent graduation



Capacity ml	Dia. top mm	Dia. bottom mm	Height mm	Item no.
100	50	40	80	7102-0100 N3
250	70	50	120	7102-0250 N3
500	91	75	140	7102-0500 N3
1000	116	95	181	7102-1000 N3
2000	150	125	213	7102-2000 N3
3000	170	120	242	7102-3000 N3
5000	210	160	270	7102-5000 N3

Laboratory beakers/Griffin beakers, PP



Laboratory beakers according to ISO 7056, based on DIN EN ISO 3819 (glass, formerly DIN 12331) for various uses. When bought in bulk, individual print is possible.

- ▶ PP, highly transparent
- ▶ Blue graduation printed on
- ▶ Shatterproof
- ▶ Autoclavable

Laboratory beakers/Griffin beakers, PP					
Capacity ml	Division ml	Scaling from ml	Dia. mm	Height mm	Item no.
25	1	5	34	49	7122-0025 N3
50	5	10	43	60	7122-0050 N3
100	5	10	51	72	7122-0100 N3
150	5	10	58	82	7122-0150 N3
250	5	20	70	95	7122-0250 N3
400	10	20	80	110	7122-0400 N3
500	50	50	94	118	7122-0500 N3
600	25	50	93	125	7122-0600 N3
1000	50	100	108	148	7122-1000 N3
2000	100	200	140	188	7122-2000 N3
3000	250	500	170	212	7122-3000 N3
5000	500	500	203	247	7122-5000 N3

Graduated beakers, stackable



Graduated beaker with graduation printed in blue, open handle, conical. Beakers can be stacked and therefore save space during storage.

- ▶ PP, transparent
- ▶ Sterilisable
- ▶ Shatterproof
- ▶ Good chemical resistance

Graduated beakers, stackable				
Capacity ml	Division ml	Height mm	Dia. top mm	Item no.
1000	10	167	125	7110-1000 N3
2000	20	212	148	7110-2000 N3

Graduated cylinders, tall form



Measuring cylinder, tall shape, according to DIN 12681 (Glass)/ISO 6706, with hexagonal base. For use in laboratories, chemists, in workshops, during outdoor field work and wherever volumetric measurements have to be made during production.

Graduated cylinders, tall form, made of SAN



- ▶ SAN, crystal clear
- ▶ Category B (DIN 12681 / ISO 6706)
- ▶ Embossed graduation with rings at the main points
- ▶ Adjusted to "In"
- ▶ Temperature resistant from -40 °C up to +70 °C

Graduated cylinders, tall form, made of SAN

Capacity ml	Division ml	Outer dia. mm	Stand dia. mm	Height mm	Item no.
100	1	34	65	260	7506-0100 N3
500	5	61	95	350	7506-0500 N3
1000	10	76	125	415	7506-1000 N3







Graduated cylinders made of PP

Graduated cylinders made of PP







- ▶ PP, highly transparent
- ▶ Category B (DIN 12681 / ISO 6706)
- ▶ Embossed blue graduation with rings at the main points
- ▶ Shatterproof
- ▶ Adjusted to "In"

- ▶ PP, highly transparent
- ▶ Category B (DIN 12681 / ISO 6706)
- ▶ Embossed transparent graduation with rings at the main points
- ▶ Shatterproof
- ▶ Adjusted to "In"

Graduated cylinders, embossed blue graduations     

Capacity ml	Division ml	Outer dia. mm	Stand dia. mm	Height mm	Item no.
50	1	27	55	200	7503-0050 N3
100	1	33	65	250	7503-0100 N3
250	2	44	75	315	7503-0250 N3
500	5	58	95	360	7503-0500 N3
1000	10	69	125	440	7503-1000 N3
2000	20	97	160	482	7503-2000 N3

Graduated cylinders, PP, embossed graduations     

Capacity ml	Division ml	Outer dia. mm	Stand dia. mm	Height mm	Item no.
50	1	27	55	200	7502-0050 N3
100	1	33	65	250	7502-0100 N3
250	2	44	75	315	7502-0250 N3
500	5	58	95	360	7502-0500 N3
1000	10	69	125	440	7502-1000 N3
2000	20	97	160	482	7502-2000 N3

Measuring jugs industrial



Light and handy polypropylene measuring jug is suitable for industrial applications. The measuring jug has two measuring scales, embossed transparent and with blue lettering. With ergonomic handle, available in closed design for special stability or with open handle for stacking to save space. The measuring jug is made of polypropylene and is therefore highly resistant to acids, bases and chemicals.

Measuring jug industrial, with closed handle

Capacity ml	Dia. mm	Height mm	Division ml	Item no.	
500	90	135	10	7204-0500	N3
1000	117	165	10	7204-1000	N3
2000	151	206	20	7204-2000	N3
3000	175	238	50	7204-3000	N3
5000	203	257	100	7204-5000	N3

Measuring jug industrial, stacking

Capacity ml	Dia. mm	Height mm	Division ml	Item no.	
500	90	135	10	7210-0500	N3
1000	117	165	10	7210-1000	N3
2000	151	206	20	7210-2000	N3
3000	175	238	50	7210-3000	N3
5000	203	257	100	7210-5000	N3

- ▶ PP transparent
- ▶ With embossed graduation printed in blue

Please inquire about special prices for large quantities!

Bulk prices

Universal graduated beakers



Universal graduated beakers with indestructible graduation. The three specially formed spouts enable easy pouring of liquids. Due to great pricing, they can also be used as disposable graduated beakers.

- ▶ PP, transparent, autoclavable
- ▶ Space-saving stacking in one another

 Attention! Make sure to pay attention to the "List of Chemical Resistance"!

 **Bulk prices**



Universal graduated beakers

Capacity ml	Dia. bottom mm	Dia. top mm	Division ml	Item no.
50	31	45	5	7109-0050 N3
100	38	55	10	7109-0100 N3
250	48	75	10	7109-0250 N3
400	51	83	20	7109-0400 N3
1000	72	113	50	7109-1000 N3



Titration burette automatic



Burette with Schellbach stripes type Schilling / Bürkle with original Bürkle dosing armature. A universal aid in the laboratory, electroplating industry, water treatment plants, for field analyses, etc. Precise dosing using the press button, exact fine titration with the micro-screw and precise discharge jet. Graduation according to Category B (Tolerances according to DIN EN ISO 385).

- ▶ Adjusted for Ex
- ▶ Burette made of borosilicate glass 3.3
- ▶ Resistant to chemicals
- ▶ Blue ring graduations (Colordur)
- ▶ Left or right hand operation possible
- ▶ Sturdy stand
- ▶ Precise discharge jet, allowing very fine drops
- ▶ Parts in contact with the medium: PE, PP, natural rubber, borosilicate glass

! Attention! Make sure to pay attention to the "List of Chemical Resistance"!



Titration burette automatic

Burette capacity ml	Division ml	Precision ml	Height cm	Capacity l	Item no.	DIN
5	0.05	± 0.03	61	0.5	9695-1005	N4
10	0.05	± 0.045	56	0.5	9695-1010	N4
15	0.1	± 0.045	52	0.5	9695-1015	N4
25	0.1	± 0.075	65	1	9695-1025	N4
50	0.1	± 0.075	92	1	9695-1050	N4

Splinter-proof titrating burette

The titrating burette with splinter protection is a fast acting burette with Schellbach stripes based on Dr. Schilling's design with automatic zero point extraction and Bürkle dosing armature.

The glass burette has a plastic sheathing which increases resistance to breaking and protects against splinters. The possibility of the burette breaking is much lower than with a conventional burette, and if it does break, there will be no dangerous splinters.

The Bürkle dosing armature allows for precise dosing and exact fine titration with the press button or micro-screw and precise discharge through the discharge jet.

- ▶ Burette with splinter-proof sheathing
- ▶ Adjusted to Ex
- ▶ Burette made of borosilicate glass 3.3
- ▶ Shatter-proof, resistant to chemicals
- ▶ Sturdy stand
- ▶ Precise discharge jet, allowing very fine drops
- ▶ Parts in contact with medium: PE, PP, natural rubber, borosilicate glass



Splinter-proof titrating burette

Burette capacity ml	Division ml	Precision ml	Height cm	Capacity l	Item no.
15	0.1	± 0.045	52	0.5	9695-3015 N4
25	0.1	± 0.075	65	1	9695-3025 N4
50	0.1	± 0.075	92	1	9695-3050 N4

DIN



Single-use pipettes PS

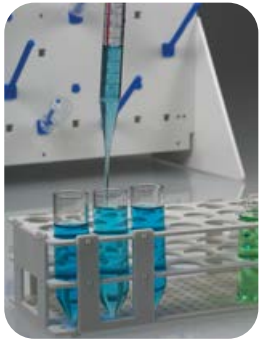

- ▶ Polystyrene, crystal clear
- ▶ Individually sterile-packed
- ▶ For aqueous solutions
- ▶ Adjusted to "In" $\pm 2\%$

Disposable pipettes LDPE



- ▶ LDPE
- ▶ dropping pipette, not graduated

Single-use pipettes PS

Capacity ml	Item no.			
25	7556-0025 N3			
50	7556-0050 N3			
100	7556-0100 N3			

Disposable pipettes LDPE

Capacity ml	Length mm	Pieces per pack	Item no.		
1.8	98	100	7555-0001 N4		
1.7	145	100	7555-0002 N4		
2.4	155	100	7555-0003 N4		

Graduated pipettes



- ▶ PP, transparent
- ▶ Blue, permanently coloured graduation and labelling
- ▶ Adjusted for Ex ± 0.1 ml

Graduated pipettes

Capacity ml
10

Item no.
7550-0010 N3



Single mark pipettes



- ▶ PP, transparent
- ▶ Blue, permanently coloured graduation and labelling

Single mark pipettes

Capacity ml
10
25
50

Item no.
7553-0010 N3
7553-0025 N3
7553-0050 N3



Pi-Pump

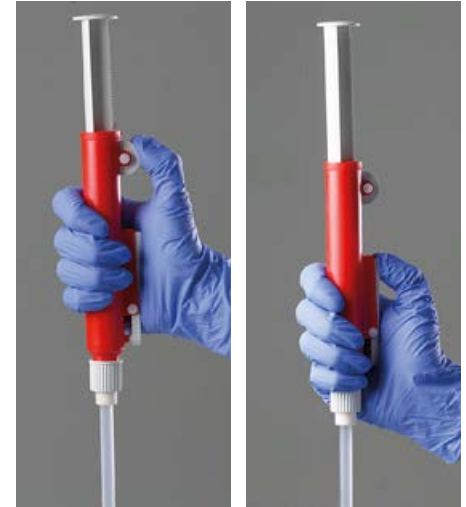

Suction via handwheel. If the handwheel is stopped, the piston remains in place and no liquid flows out

Discharge via outlet lever. Very small quantities can be removed with great accuracy by turning the hand-wheel

Proven thousands of time, fits naturally into the hand. The handwheel ensures precise suction. The contents can be purged by pressing back the piston. Dispensing with the lateral switch.

- ▶ Easy to use, precise
- ▶ Available in three sizes (colour-coded)

Pi-Pump

Fits for pipette up to ... ml

Colour

Item no.

2	blue	7551-0002 N3
10	green	7551-0010 N3
25	red	7551-0025 N3

Safety pipetting-ball

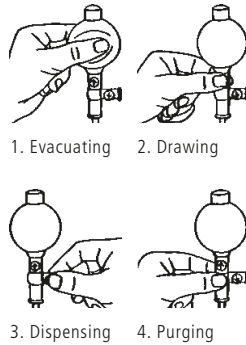

Peleus ball, simple pipetting aid. Evacuation takes place via an automatic valve. By pressing the valves, the liquid is drawn up, dispensed or purged. The removable automatic valve also enables effective cleaning of the inside.

- ▶ For all pipettes up to 100 ml
- ▶ Available in various colours

Safety pipetting-ball

Colour	Item no.
red	7554-0002 N3
yellow	7554-0004 N3
blue	7554-0005 N3
green	7554-0006 N3

Pipette rinsing system



① Pipette rinsing system

For easy and gentle cleaning and safe storage of pipettes. A complete system suitable for every lab.

- ▶ PE transparent
- ▶ Effective height 600 mm

② Pipette basket

The basket is an accessory for the pipette rinser.

① Pipette rinsing system

Capacity l	Inner dia. mm	Stand dia. mm	Height mm	Item no.
17	165	315	740	9650-0650 N3

② Pipette basket

Capacity l	Stand dia. mm	Height mm	Item no.
17	145	280	9650-0653 N3

③ Cleaning and storage container for pipettes

Capacity l	Inner dia. mm	Outer dia. mm	Stand dia. mm	Height mm	Item no.
10	155	165	240	550	9650-0651 N3
12.5	155	165	240	660	9650-0652 N3

Pipette stand

Frame for pipettes with two rotating perforated plates and drip pan. The holders are suitable for up to 40 pipettes of different sizes, for all measuring and full pipettes up to a max. diameter of 18 mm. A drip pan protects the tips of the pipettes and collects liquid as it drips off.

The pipette stand is suitable for drying and for space-saving storage of pipettes or thermometers, test tubes and similar items. A very sturdy pedestal ensures absolute safety against overturning.

No clamping screws are necessary thanks to an innovative magnet concept. The height of the holding plates can be adjusted easily and flexibly with one hand.

The lab frame can be flexibly adapted with corresponding accessories, for example as a frame for Imhoff sedimentation funnels (see page 227) or as a funnel frame (see page 226).

- ▶ PP, chrome-plated steel
- ▶ Adjustable height up to 450 mm
- ▶ 40 slots, Ø 10–18 mm



Pipette stand

Item no.

9630-0090

N4

Accessories

Description

Item no.

Funnel holder with reducing insert, for funnels Ø 40-180 mm 9622-0001 N4

Sedimentation funnel holder for Imhoff funnels from Ø 90 mm 7118-2001 N4



Draining rack, wallmount | practical, hygienic, attractive shape

Draining rack made of plastic, shatterproof, proven thousands of times in the lab and adjusted to the requirements there.

The stable rods are individually placed into the holes of the draining rack and are clicked into place. Their positions can be changed at any time. Using a combination of rods of three different lengths (60 mm, 100 mm and extension to 150 mm), the draining rack can be adapted to any apparatus which is to be dried.

Available in three different sizes:

- ▶ **Draining rack 40x40 cm** with rods 60 mm (5x), 100 mm (26x) and extension 150 mm (2x)
- ▶ **Draining rack 50x50 cm** with rods 60 mm (10x), 100 mm (39x) and extension 150 mm (4x)
- ▶ **Draining rack 60x60 cm** with rods 60 mm (15x), 100 mm (56x) and extension 150 mm (6x)

Extension Item No. 9640-0415 can only be used with rod Item No. 9640-0410.

Available as:

- ▶ Draining rack, wallmount, incl. wall mounting set (screws, dowels), optionally available with removable draining channel which has a connection for a draining tube (The drainage water goes into the lab basin)
- ▶ Draining rack, benchtop, with collecting pan
- ▶ Draining rack PVC, rods PP
- ▶ Incl. spanner for the rods

 Attention! Make sure to pay attention to the "List of Chemical Resistance"!



Draining rack, wallmount

Model	W x H mm	Item no.	
without draining channel	400 x 400	9640-1040	N4
without draining channel	500 x 500	9640-1050	N4
without draining channel	600 x 600	9640-1060	N4
with draining channel	400 x 400	9640-2040	N4
with draining channel	500 x 500	9640-2050	N4
with draining channel	600 x 600	9640-2060	N4

Accessories

Description	Item no.
Rods for draining rack length 60 mm, dia. 6 mm	9640-0421 N4
Rods for draining rack length 100 mm, dia. 10 mm	9640-0410 N4
Extension rods for draining rack length 150 mm, dia. 12 mm	9640-0415 N4

Draining rack, benchtop



The draining rack is easy and flexible to set down on a table or working surface. Two large supports with wide bases ensure sufficient stability. Since both sides of the draining board can be used, it provides twice the hanging space. The collecting pan can simply be removed for emptying.

- ▶ Flexible, can be used on both sides



Draining rack, benchtop



W x H mm	Item no.
400 x 400	9640-3040 N4
500 x 500	9640-3050 N4
600 x 600	9640-3060 N4

Accessories

Description	Item no.
Rods for draining rack length 60 mm, dia. 6 mm	9640-0421 N4
Rods for draining rack length 100 mm, dia. 10 mm	9640-0410 N4
Extension rods for draining rack length 150 mm, dia. 12 mm	9640-0415 N4

Test-tube racks

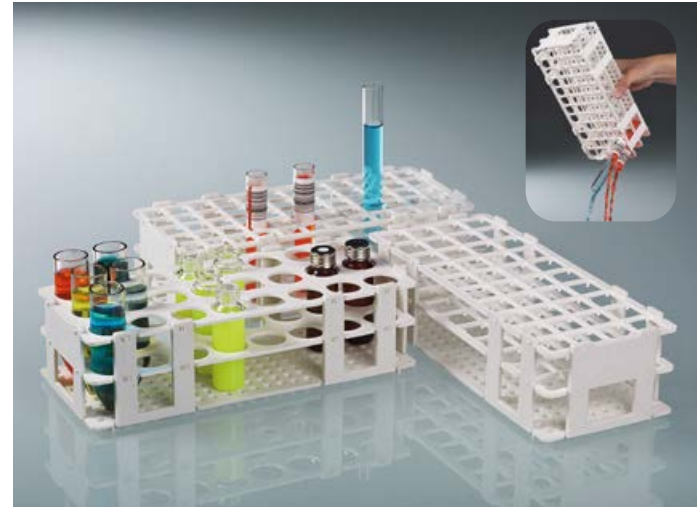

Universal test tube rack with retention system. Allows all test tubes to be emptied simultaneously. Suitable for test tubes in most standard diameters. Alphanumerically marked positions for specific identification of samples. Test tube rack with 24 storing positions without retention system.

- ▶ PP, white, shatterproof
- ▶ Steam sterilisable up to +121 °C
- ▶ Dimensions: 246 x 104 x 64 mm

Test-tube racks



For tubes up to ... dia. mm	Colour	No. of tubes	Item no.
16	white	60	9635-0021 N3
25	white	24	9635-0041 N3

SnowPack® dry ice machine | -79 °C cryogenic cooling on-tap



SnowPack® enables you to obtain a -79 °C dry ice tablet weighing 50 or 250 g within a few moments, without complicated technology and without electricity! You can therefore obtain low-cost cooling to very low temperatures at any time you like.

SnowPack® is often used in hospitals, universities, schools, institutes, laboratories, in the chemical industry and in materials testing facilities.

Examples of use: Lowering the temperature in cooling baths or cold traps, pre-cooling tissue samples, ensuring safe transport or embedding biological substances, freezing blood and tissue samples, studies in chemistry, physics and materials technology, etc. Dry ice is easy to handle, odourless and flavourless. The SnowPack® dry ice machine can be installed on any commercial CO₂-bottle with a standpipe (without pressure regulator) (thread W 21.80 x 1/14" according to DIN 477-1 No. 6). These often exist in many

production facilities and laboratories anyway. If this is not the case, a bottle can be rented for a small price from a local specialist gas distributor.

The use of SnowPack® is easy:

1. Simply screw SnowPack® onto a CO₂ bottle with standpipe.
2. Open the valve, CO₂ gas flows into the SnowPack® and crystallises to dry ice.
3. Open the clamp.
4. Take out the dry ice pellet.



- ▶ Ideal cooling media for sample transport
- ▶ Performance depends on room temperature and pressure



SnowPack® dry ice machine

Model	Tablet dia. x H mm	Weight g	Gas escape time approx. min	Tablets per 22 kg bottle	Item no.
SnowPack® 50	50 x 30	50	1	approx. 90	9805-0030 N4
SnowPack® 250	80 x 60	250	1	approx. 16	9805-0200 N4

PVC pressure tubing



Fabric reinforced, permanent transparency, increased flexibility, high chemical resistance, excellent ageing and abrasion resistance, environmentally friendly, cadmium-free. Foodstuffs quality according to the EC Guideline 1935/2004.

- ▶ Clear
- ▶ Hardness Shore A 70 ± 3
- ▶ Operating temperature -20 °C to +60 °C
- ▶ TÜV-approved (German industry standards)

! The pressure figures are maximum values (bursting pressure) under optimum ambient conditions. The user is responsible for determining any suitability!

PVC pressure tubing

Inner dia. mm	Roll length m	Outer dia. mm	Wall thickness mm	Pressure max. bar	Item no.	
6	10	12	3	20	8802-0612	N3
6	50	12	3	20	8876-0612	N3
8	10	14	3	18	8802-0814	N3
8	50	14	3	18	8876-0814	N3
9	10	15	3	16	8802-0915	N3
9	50	15	3	16	8876-0915	N3
10	10	16	3	14	8802-1016	N3
10	50	16	3	14	8876-1016	N3
12	10	18	3	14	8802-1218	N3
12	50	18	3	14	8876-1218	N3
13.2	10	20	3.3	12	8802-1320	N3
13.2	50	20	3.3	12	8876-1320	N3

Accessories

Description	Item no.
Hose cutter	0006-9506 N3

PVC industrial tubing



Hose made of soft PVC, cadmium-free, with high resistance to chemicals, high flexibility and permanent crystal clear transparency and excellent abrasion resistance. Foodstuffs quality according to the EC Guideline 1935/2004.

- ▶ Clear
- ▶ Hardness Shore A 80 ± 3
- ▶ Operating temperature -20 °C to +50 °C
- ▶ For pressureless operation

PVC industrial tubing

Inner dia. mm	Roll length m	Outer dia. mm	Wall thickness mm	Item no.	
2	10	4	1	8801-0204	N3
2	100	4	1	8875-0204	N3
3	10	5	1	8801-0305	N3
3	100	5	1	8875-0305	N3
4	10	6	1	8801-0406	N3
4	100	6	1	8875-0406	N3
5	10	7	1	8801-0507	N3
5	100	7	1	8875-0507	N3
6	10	8	1	8801-0608	N3
6	100	8	1	8875-0608	N3
7	10	10	1.5	8801-0710	N3
7	100	10	1.5	8875-0710	N3
8	10	11	1.5	8801-0811	N3
8	50	11	1.5	8875-0811	N3
9	10	12	1.5	8801-0912	N3
9	50	12	1.5	8875-0912	N3
10	10	13	1.5	8801-1013	N3
10	50	13	1.5	8875-1013	N3
12	10	16	2	8801-1216	N3
12	50	16	2	8875-1216	N3
13	10	19	3	8801-1319	N3
13	50	19	3	8875-1319	N3
19	10	25	3	8801-1925	N3
19	50	25	3	8875-1925	N3

Accessories

Description	Item no.
Hose cutter	0006-9506 N3

PTFE tubing

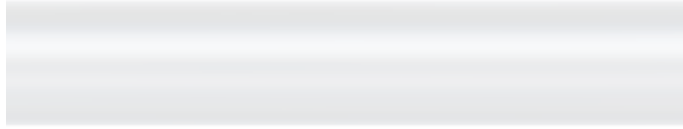

Excellent properties: Extremely high chemical resistance against nearly all chemicals, smallest frictional coefficient, excellent anti-adhesive qualities/residue emptying. PTFE hoses do not emit odours, do not burn or smoke and are resistant to ageing and UV light. Not resistant to fluorine compounds or strong reducing agents.

- ▶ Transparent
- ▶ Hardness Shore D 55
- ▶ Temperature -200 °C to +260 °C
- ▶ Autoclavable, ethylene oxide
- ▶ Flavour and odour neutral

The pressure figures are maximum values (bursting pressure) under optimum ambient conditions. The user is responsible for determining any suitability!

PTFE tubing					
Inner dia. mm	Roll length m	Outer dia. mm	Wall thickness mm	Pressure max. bar	Item no.
1	5	3	1	240	8804-0103 N3
1	50	3	1	240	8879-0103 N3
2	5	4	1	120	8804-0204 N3
2	50	4	1	120	8879-0204 N3
3	5	5	1	80	8804-0305 N3
3	50	5	1	80	8879-0305 N3
4	5	6	1	60	8804-0406 N3
4	50	6	1	60	8879-0406 N3
6	5	8	1	40	8804-0608 N3
6	50	8	1	40	8879-0608 N3
8	5	10	1	30	8804-0810 N3
8	50	10	1	30	8879-0810 N3
10	5	12	1	20	8804-1012 N3
10	50	12	1	20	8879-1012 N3

Accessories	
Description	Item no.
Hose cutter	0006-9506 N3

PE tubing



The PE hose is recognised as safe physiologically, resistant against (non-oxidizing) acids, caustic solutions, salts and a number of solvents, pressure resistant, flexible, impact resistant, light, resistant to compression, up to + 80 °C deformation resistant.

- ▶ Transparent
- ▶ Hardness Shore A 80 ± 3
- ▶ Temperature -40 °C to +95 °C
- ▶ Suitable for food

The pressure figures are maximum values (bursting pressure) under optimum ambient conditions. The user is responsible for determining any suitability!

PE tubing					
Inner dia. mm	Roll length m	Outer dia. mm	Wall thickness mm	Pressure max. bar	Item no.
3	10	5	1	13	8805-0305 N3
3	100	5	1	13	8878-0305 N3
4	10	6	1	10	8805-0406 N3
4	100	6	1	10	8878-0406 N3
6	10	8	1	7	8805-0608 N3
6	100	8	1	7	8878-0608 N3
10	10	14	2	8	8805-1014 N3
10	100	14	2	8	8878-1014 N3
12	10	16	2	7	8805-1216 N3

Accessories	
Description	Item no.
Hose cutter	0006-9506 N3

Silicone tubing



Very flexible, transparent hose. Good resistance against weak acids and alkalis. Do not use for strong acids and caustic solutions. Swells in organic solvents. Largely nonreactive to ionising solvents except chlorinated aliphatic and aromatic hydrocarbons.

- ▶ Transparent
- ▶ Hardness Shore A 60 ± 5
- ▶ Temperature -60 °C up to +180 °C
- ▶ Autoclavable, ethylene oxide
- ▶ Suitable for food

Silicone tubing				autoLine 121°	↓	↑
Inner dia. mm	Roll length m	Outer dia. mm	Wall thickness mm	Item no.		
3	5	5	1	8803-0305	N3	
3	25	5	1	8881-0305	N3	
4	5	6	1	8803-0406	N3	
4	25	6	1	8881-0406	N3	
5	5	8	1.5	8803-0508	N3	
5	25	8	1.5	8881-0508	N3	
6	5	9	1.5	8803-0609	N3	
6	25	9	1.5	8881-0609	N3	
7	5	10	1.5	8803-0710	N3	
7	25	10	1.5	8881-0710	N3	
8	5	12	2	8803-0812	N3	
8	25	12	2	8881-0812	N3	
10	5	15	2.5	8803-1015	N3	
10	25	15	2.5	8881-1015	N3	
12	5	16	2	8803-1216	N3	
12	25	16	2	8881-1216	N3	

Accessories

Description	Item no.
Hose cutter	0006-9506 N3

Hose cutter



Edges cut with the hose cutter are always clean and flat, even in the case of thick hoses. For hoses to Ø 20 mm.

Hose cutter

Item no.
0006-9506

N3

Make connections – with Bürkle LaboPlast® hose connectors



Bürkle offers a large portfolio of different hose connectors that are used to extend, connect, branch, join and repair hoses, etc.

The ranges of application are diverse and thus the requirements for shape, size and material properties are broadly based.



b LaboPlast



We produce our LaboPlast® hose connectors in many sizes and shapes (I, T, Y, X, L) to be able to also safeguard a flexible and safe solution and connection for demanding applications at all times.



We offer these connectors made of polypropylene as standard. However here we would like to point out our connectors made of PVDF (polyvinylidene fluoride).



Do you prefer moving images of our connectors? – No problem! Visit us at

www.buerkle.de/videos

or simply scan the code opposite with your smartphone and select the films that you find interesting.

PVDF – for demanding applications

PVDF is a fluoropolymer with superior product properties:

- ▶ Highest chemical resistance
- ▶ High temperature resistance (up to 160 °C)
- ▶ Food industry approval
- ▶ Autoclavable
- ▶ UV-resistant

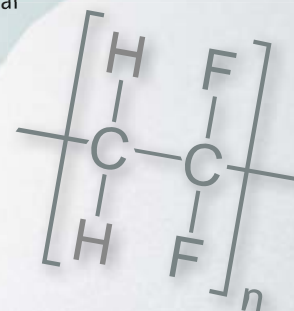

If you value high-quality and flexible solutions for demanding applications, test our unique connector made of PVDF.

Improve your connections – with Bürkle LaboPlast® PVDF hose connectors!



Y-connectors



Cylindrical Y hose connector to connect hoses.

- ▶ PP, Temperature resistant up to +135 °C max.
- ▶ PVDF, Temperature resistant up to +160 °C max., highly resistant to chemicals
- ▶ Sterilisable

Y-connectors							
Material	For dia. mm	Pieces per pack	Item no.				
PP	3-5	10	8706-0004	N4			
PP	5-7	10	8706-0006	N4			
PP	6-8	10	8706-0007	N4			
PP	7-9	10	8706-0008	N4			
PP	9-11	10	8706-0010	N4			
PP	11-13	10	8706-0012	N4			
PP	13-15	10	8706-0014	N4			
PVDF	3-5	10	8712-0004	N4			
PVDF	5-7	10	8712-0006	N4			
PVDF	7-9	10	8712-0008	N4			
PVDF	9-11	10	8712-0010	N4			
PVDF	11-13	10	8712-0012	N4			
PVDF	13-15	10	8712-0014	N4			

T-connectors

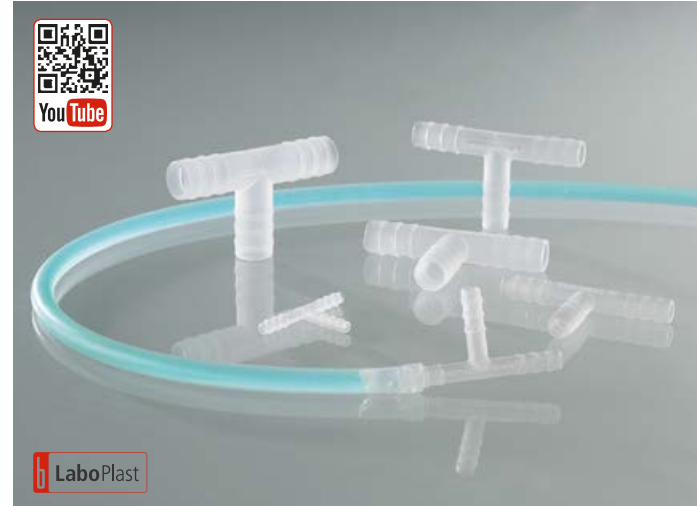

Cylindrical T hose connector to connect hoses.

- ▶ PP, Temperature resistant up to +135 °C max.
- ▶ PVDF, Temperature resistant up to +160 °C max., highly resistant to chemicals
- ▶ Sterilisable

T-connectors							
Material	For dia. mm	Pieces per pack	Item no.				
PP	3-5	10	8705-0004	N4			
PP	5-7	10	8705-0006	N4			
PP	7-9	10	8705-0008	N4			
PP	9-11	10	8705-0010	N4			
PP	11-13	10	8705-0012	N4			
PP	13-15	10	8705-0014	N4			
PVDF	3-5	10	8711-0004	N4			
PVDF	5-7	10	8711-0006	N4			
PVDF	7-9	10	8711-0008	N4			
PVDF	9-11	10	8711-0010	N4			
PVDF	11-13	10	8711-0012	N4			
PVDF	13-15	10	8711-0014	N4			

Angled connectors



Cylindrical angle hose connector to connect hoses.

- ▶ PP, Temperature resistant up to +135 °C max.
- ▶ PVDF, Temperature resistant up to +160 °C max., highly resistant to chemicals
- ▶ Sterilisable

Angled connectors							
Material	For dia. mm	Pieces per pack	Item no.				
PP	3-5	10	8707-0004	N4			
PP	5-7	10	8707-0006	N4			
PP	7-9	10	8707-0008	N4			
PP	9-11	10	8707-0010	N4			
PP	11-13	10	8707-0012	N4			
PP	13-15	10	8707-0014	N4			
PVDF	3-5	10	8713-0004	N4			
PVDF	5-7	10	8713-0006	N4			
PVDF	7-9	10	8713-0008	N4			
PVDF	9-11	10	8713-0010	N4			
PVDF	11-13	10	8713-0012	N4			
PVDF	13-15	10	8713-0014	N4			

Four-way-connectors



Cylindrical four-way hose connector to connect hoses.

- ▶ PP, Temperature resistant up to +135 °C max.
- ▶ PVDF, Temperature resistant up to +160 °C max., highly resistant to chemicals
- ▶ Sterilisable

Four-way-connectors							
Material	For dia. mm	Pieces per pack	Item no.				
PP	3-5	10	8708-0004	N4			
PP	5-7	10	8708-0006	N4			
PP	7-9	10	8708-0008	N4			
PP	9-11	10	8708-0010	N4			
PP	11-13	10	8708-0012	N4			
PP	13-15	10	8708-0014	N4			
PVDF	3-5	10	8717-0004	N4			
PVDF	5-7	10	8717-0006	N4			
PVDF	7-9	10	8717-0008	N4			
PVDF	9-11	10	8717-0010	N4			
PVDF	11-13	10	8717-0012	N4			
PVDF	13-15	10	8717-0014	N4			

Hose tubing connectors, straight, cylindrical

Universal hose tubing connectors



Cylindrical straight hose connectors for various hose sizes.

Conical, straight hose connectors for universal use.

- ▶ PP, Temperature resistant up to +135 °C max.
- ▶ PVDF, Temperature resistant up to +160 °C max., highly resistant to chemicals
- ▶ Sterilisable

- ▶ PP, Temperature resistant up to +135 °C max.
- ▶ PVDF, Temperature resistant up to +160 °C max., highly resistant to chemicals
- ▶ Sterilisable

Hose tubing connectors, straight, cylindrical nozzles			
Material	For dia. mm	Pieces per pack	Item no.
PP	3-5	10	8701-0004 N4
PP	5-7	10	8701-0006 N4
PP	7-9	10	8701-0008 N4
PP	9-11	10	8701-0010 N4
PP	11-13	10	8701-0012 N4
PP	13-15	10	8701-0014 N4
PVDF	3-5	10	8710-0004 N4
PVDF	5-7	10	8710-0006 N4
PVDF	7-9	10	8710-0008 N4
PVDF	9-11	10	8710-0010 N4
PVDF	11-13	10	8710-0012 N4
PVDF	13-15	10	8710-0014 N4

Universal hose tubing connectors with conical nozzles			
Material	For dia. mm	Pieces per pack	Item no.
PP	4-17	10	8700-0417 N4
PVDF	4-17	10	8710-0417 N4

Hose tubing connectors



Conical, straight hose connectors for various hose sizes.

- ▶ PP
- ▶ Sterilisable

Reducing hose connectors



Reducing nozzles for the reduction from big-ger to small hoses.

- ▶ PP
- ▶ Sterilisable

Hose couplings



Attachable, conical hose couplings for pres-sureless operation.

- ▶ PE

Hose tubing connectors, straight, conical



For dia. mm	Pieces per pack	Item no.
3-5	10	8700-0406 N3
5-7	10	8700-0608 N3
7-10	10	8700-0810 N3
9-12	10	8700-1012 N3
11-14	10	8700-1214 N3
13-15	10	8700-1416 N3

Reducing hose connectors



For dia. mm	Pieces per pack	Item no.
4-8/8-12	10	8703-0408 N3
4-8/12-16	10	8703-0412 N3
8-12/12-16	10	8703-0812 N3

Hose couplings



For dia. mm	Pieces per pack	Item no.
3-5	10	8704-0406 N3
5-7	10	8704-0608 N3
7-10	10	8704-0810 N3
9-12	10	8704-1012 N3
11-14	10	8704-1214 N3
13-16	10	8704-1416 N3

Non-return valves



Retaining valve with embossed directional arrow or printed in black. With conical nozzles. Various uses.

- ▶ Resistant to compression max. 4 bar
- ▶ Operating temperature +0 to +40 °C
- ▶ With PP valve ball, on request also with ball made of stainless steel or PTFE



Non-return valves with conical inlet/outlet



For dia. mm	Print	Item no.	
① 6-8	embossed	8714-0060	N4
① 8-10	embossed	8714-0080	N4
① 10-14	embossed	8714-0100	N4
② 6-8	black	8714-1006	N4
② 8-10	black	8714-1008	N4
② 10-14	black	8714-1010	N4

Magic Box



In this magic box, you can invariably find the appropriate hose connector you are looking for. Magic box includes 68 connectors: **Two of each** in sizes **4, 6, 8, 10, 12 and 14 mm**

- ▶ Straight hose connector Item No. 8701-
- ▶ T hose connector Item No. 8705-
- ▶ Y hose connector Item No. 8706-
- ▶ X hose connector Item No. 8708-
- ▶ Angle hose connector Item No. 8707-

Two of each for hoses from **4-17 mm**

- ▶ Universal hose connector Item No. 8700-0417

Two of each in sizes **4-8, 4-12 and 8-12 mm**

- ▶ Reducing hose connector Item No. 8703-
- ▶ PP, shatterproof and transparent

Magic Box

Item no.
8715-1000



N4

Flow indicators



Flow indicators give precise visual indication of the flow velocity of liquids or gases being transported through hose connections. The flow indicator with impeller functions in both directions and in any position. The impeller (PP) starts to rotate at a flow rate about 150 ml/min (liquids).

- ▶ For hoses with inner diameter of 6–11 mm
- ▶ Pressure resistant up to 2 bar
- ▶ Length with grommets 88 mm, height 40 mm, width 16 mm
- ▶ Colour coding – blue, red and black

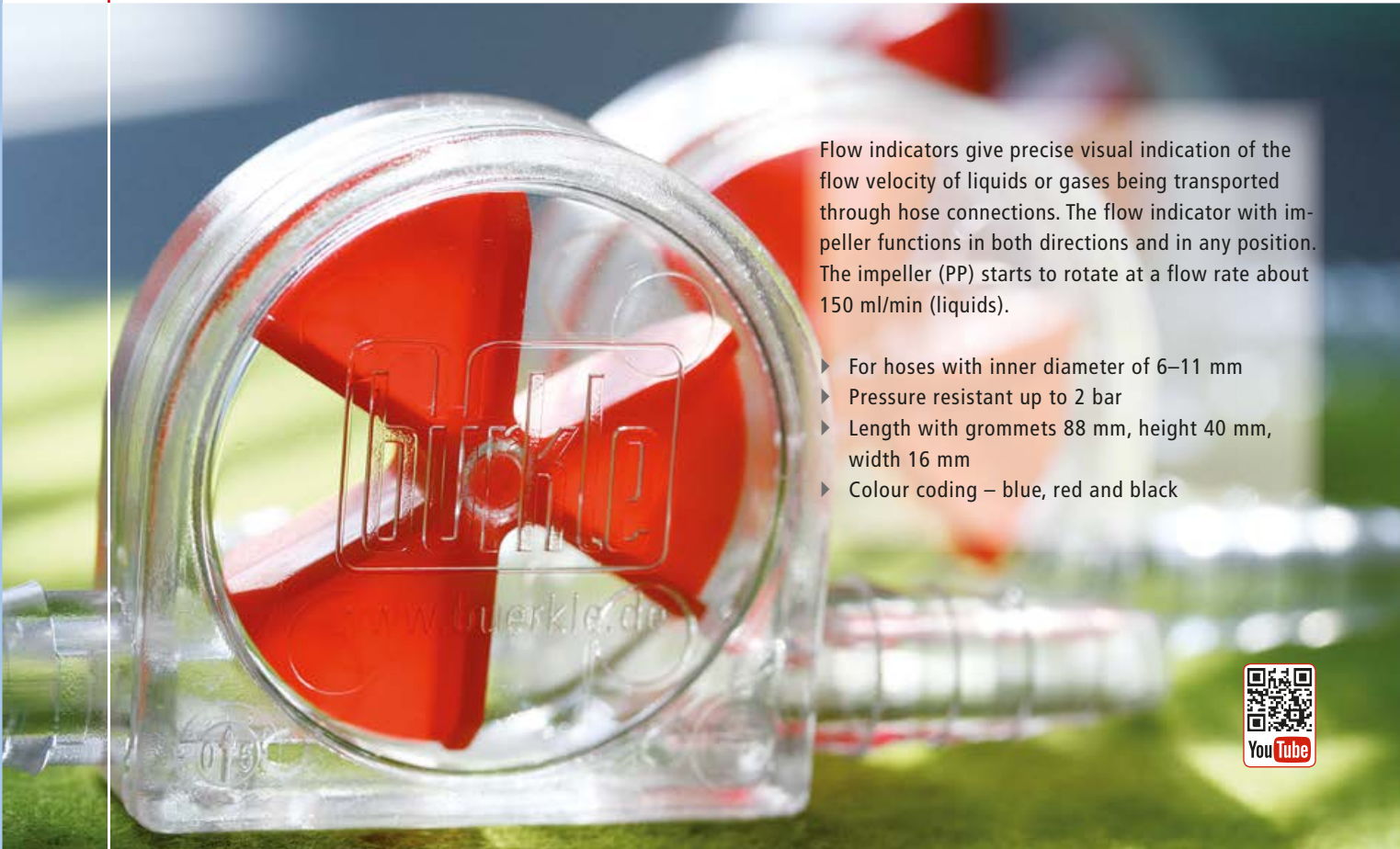

Flow indicators LiquiMobil SAN



LiquiMobil flow indicator made of SAN is mainly suitable for cooling systems and helps to reduce water consumption considerably because the cooling water flow can be adjusted better. Not suitable for aggressive substances.

- ▶ Operating temperature LiquiMobil SAN max. +30 °C

Flow indicators CheMobil PMP



CheMobil made of PMP/TPX can be used for many substances due to its good chemical resistance. Not suitable for strong acids, alkalis and solvents. CheMobil can be steam sterilised.

- ▶ Operating temperature CheMobil PMP max. +60 °C

Flow indicators LiquiMobil SAN

Colour	Item no.			
red	8720-1002 N4			
black	8720-1003 N4			
blue	8720-1005 N4			

Flow indicators CheMobil PMP

Colour	Item no.				
red	8720-2002 N4				
black	8720-2003 N4				
blue	8720-2005 N4				

stop-it tube clamps



The tubing clamp can be used wherever the flow in hoses or tubings with liquids or gases needs to be regulated or stopped.

Stepless flow regulation: With the tubing clamp stop-it's knurled screw, a stepless, delicate flow regulation or complete stop of the flow are possible, even for existing hose connections. The tubing is compressed over a wide area against the sturdy steel hook in order to prevent it from being damaged.

Tubing clamp stop-it with Easy-Click closure

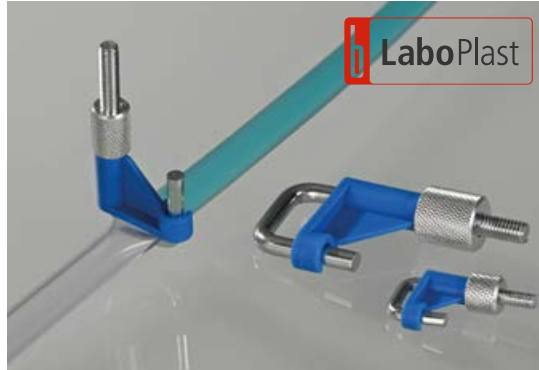

Easy-Click closure – stop-it tubing clamps can be opened and closed in any position – without tiresome screwing on and off. High quality material – stop-it made from the heat resistant and chemical resistant plastic PVDF. The hook is galvanised steel.

- ▶ PVDF, aluminium and steel, zinc coated
- ▶ Temperature resistant up to 140 °C
- ▶ For flexible hoses or tubings with outer Ø up to 10 mm, 15 mm and 20 mm
- ▶ Available in four fresh colours

Tubing clamp stop-it metal



The materials steel and aluminium ensure that the stop-it metal is extremely heat resistant and sturdy. The tubing clamp is available in four different sizes, for hose diameters up to max. 30 mm.

- ▶ Galvanised steel and aluminium
- ▶ For flexible hoses or tubings with outer Ø up to 10 mm, 15 mm, 20 mm and 30 mm

Bulk prices

Tubing clamp stop-it with Easy-Click closure

For dia. mm	Colour	Item no.	
to 10	red	8619-0102 N4	
to 10	yellow	8619-0104 N4	
to 10	blue	8619-0105 N4	
to 10	green	8619-0106 N4	
to 15	red	8619-0152 N4	
to 15	yellow	8619-0154 N4	
to 15	blue	8619-0155 N4	
to 15	green	8619-0156 N4	
to 20	red	8619-0202 N4	
to 20	yellow	8619-0204 N4	
to 20	blue	8619-0205 N4	
to 20	green	8619-0206 N4	

Tubing clamp stop-it metal

For dia. mm	Item no.		
up to 10	8619-0510 N4		
up to 15	8619-0515 N4		
up to 20	8619-0520 N4		
up to 30	8619-0530 N4		

Hose clamp Squeeze-Fix



The hose can be squeezed in phases or completely compressed, as required.

- ▶ Can be operated with one hand
- ▶ POM (white, sterilisable, does not rust, permanently elastic, hygienic)

Hose clamp Squeeze-Fix



For dia. mm	Length mm	Item no.
1-5	25	8618-0001 N3
3-10	40	8618-0002 N3
6-15	55	8618-0003 N3

Hose clips POM



Hose clips made of Polyacetal (POM).

Hose clips POM



For dia. mm	Pieces per pack	Item no.
6 - 6.5	10	8678-0006 N3
9 - 10	10	8678-0010 N3
10 - 11	10	8678-0011 N3
11 - 12	10	8678-0012 N3
12 - 14	10	8678-0014 N3
13 - 15	10	8678-0015 N3
15 - 17	10	8678-0017 N3
17 - 19	10	8678-0019 N3
18 - 20	10	8678-0020 N3
20 - 22	10	8678-0022 N3
23 - 25	10	8678-0025 N3

Worm-threaded hose clips



Hose clip sleeve made of stainless steel 1.4016, screw zinc coated, with screw thread.

Worm-threaded hose clips stainless steel

For dia. mm	Pieces per pack	Item no.
8-12	10	8677-0812 N3
10-16	10	8677-1016 N3
12-20	10	8677-1220 N3
16-27	10	8677-1625 N3
20-32	10	8677-2032 N3
25-40	10	8677-2540 N3

Two-way valves

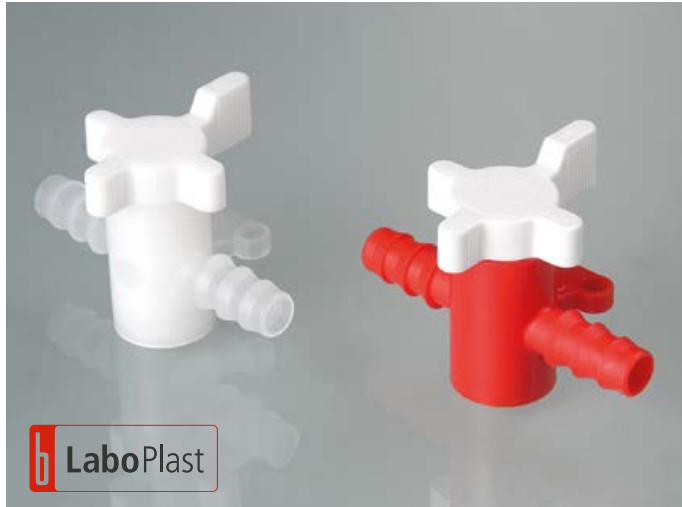

Three-way valves

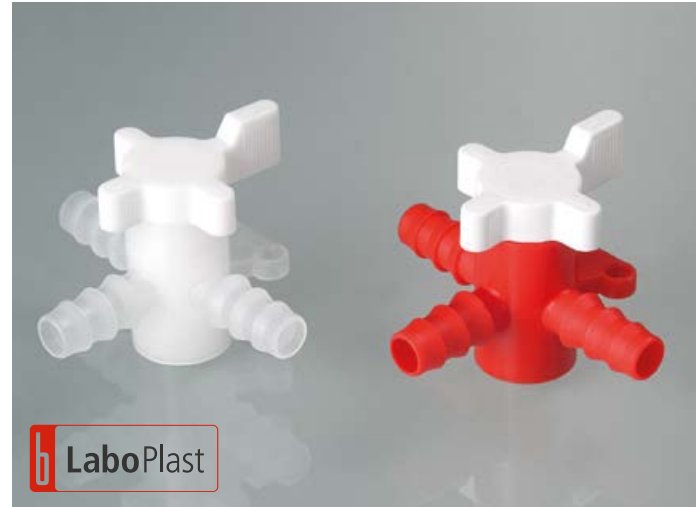

Two and three-way valves are used for transfer of liquids or gases in order to release the flow, to block it or to change its direction.

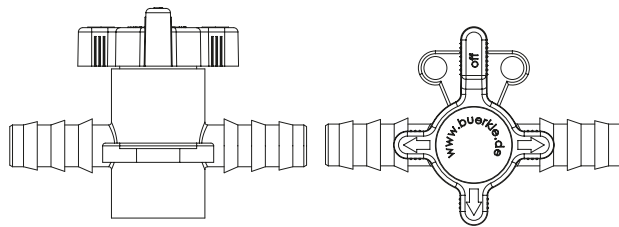

- ▶ PVDF: excellent chemical resistance, transparent, suitable for food
- ▶ PP/PE: for industrial use, red/white
- ▶ Operating temperature: PVDF +0 up to +40 °C, PP/PE +5 up to +40 °C
- ▶ Resistant to compression max. 1 bar
- ▶ With mounting plate for easy installation

Two-way valves

Material	For dia. mm	Nominal width mm	Item no.	FR	PP	PVDF	CFR
PP/PE	5-7	4	8605-0060 N4				
PP/PE	7-9	6	8605-0080 N4				
PP/PE	9-11	8	8605-0100 N4				
PP/PE	11-13	8	8605-0120 N4				
PVDF	5-7	4	8607-0060 N4				
PVDF	7-9	6	8607-0080 N4				
PVDF	9-11	8	8607-0100 N4				
PVDF	11-13	8	8607-0120 N4				

Three-way valves

Material	For dia. mm	Nominal width mm	Item no.	FR	PP	PVDF	CFR
PP/PE	5-7	4	8606-0060 N4				
PP/PE	7-9	6	8606-0080 N4				
PP/PE	9-11	8	8606-0100 N4				
PP/PE	11-13	8	8606-0120 N4				
PVDF	5-7	4	8608-0060 N4				
PVDF	7-9	6	8608-0080 N4				
PVDF	9-11	8	8608-0100 N4				
PVDF	11-13	8	8608-0120 N4				

Valves made of PTFE, two-way and three-way



Two-way / three-way valves made of solid PTFE with hose nozzles. Resistant to chemicals. Very easy connection thanks to its excellent antifriction properties. Blue handles made of PP.

- ▶ Resistant to compression max. 1 bar
- ▶ Vacuum suitable up to 5 mmHg
- ▶ Autoclavable

Valves made of PTFE, two-way and three-way

Model	For dia. mm	Nominal width mm	Item no.	
three-way valve	4.5	2	8610-0001	N4
three-way valve	6.8	3	8610-0003	N4
three-way valve	10	4	8610-0006	N4
two-way valve	4.5	2	8610-0010	N4
two-way valve	6.8	3	8610-0012	N4
two-way valve	10	4	8610-0015	N4



Hose tubing stop-cock



Simple reflux nozzle with two-sided hose nozzle.

- ▶ HDPE natural
- ▶ Resistant to acids and chemicals
- ▶ Pressure resistant up to 0.3 bar

Hose tubing stop-cock

For dia. mm	Nominal width mm	Length mm	Item no.	
9-11	7	85	8614-0007	N4
12-15	9	97	8614-0009	N4



Non-return valves with conical inlet/outlet

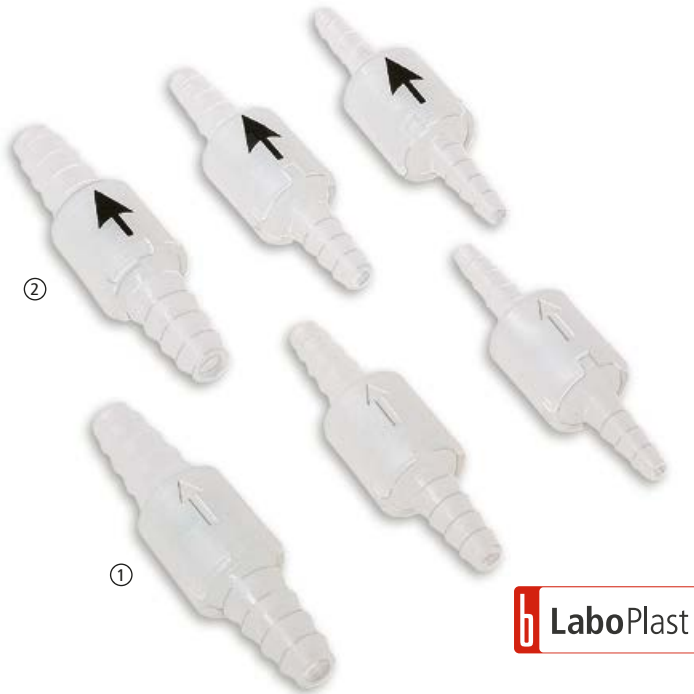

Retaining valve with embossed directional arrow or printed in black. With conical nozzles. Various uses.

- ▶ Resistant to compression max. 4 bar
- ▶ Operating temperature +0 to +40 °C
- ▶ With PP valve ball, on request also with ball made of stainless steel or PTFE

Non-return valves with conical inlet/outlet

For dia. mm	Print	Item no.		
① 6-8	embossed	8714-0060 N4		
① 8-10	embossed	8714-0080 N4		
① 10-14	embossed	8714-0100 N4		
② 6-8	black	8714-1006 N4		
② 8-10	black	8714-1008 N4		
② 10-14	black	8714-1010 N4		

Non-return valves PP



Valve made of PP and POM, seal made of EPDM, springs made of stainless steel 1.4401.

- ▶ Max. operating pressure 6 bar (at +20 °C)
- ▶ Max. operating temperature 80 °C
- ▶ Pressure difference 12 mbar

Non-return valves PP

Thread	Item no.	
1/2"	8540-0012 N3	

Rapid couplings



Fast and safe connection for liquids, gases, compressed air and vacuum. Rapid couplings are the ideal when connecting and separating hoses, machines, apparatus, containers, etc. Top quality, with tested reliability, small space requirement, maximum possible flow, easy operation (single handed operation) and an elegant design distinguish the rapid couplings. They fulfil the most stringent requirements. The couplings are available in two different materials: POM (Polyoxymethylene) and PP (Polypropylene). The rapid couplings are available with a hose nozzle, hose screw joint, thread connector or as a built-in component for control panels, with or without stop-valve respectively.

The secure O-ring guarantees that rapid couplings are leakproof. All the couplings (female connections) and nipples (male connections) that are within the same flow range are interconnecting.

- ▶ Spring/lock Stainless steel AISI 316L

Body POM:

- ▶ Seal (standard): Buna-N
- ▶ Operating pressure at 20 °C: with vacuum up to 10 bar
- ▶ Operating temperature: -40 °C to +80 °C

Body PP:

- ▶ Seal (standard): EPDM
- ▶ Operating pressure at 20 °C: up to 8 bar
- ▶ Operating temperature: 0 °C to +110 °C

Use with version with valve

1. The couplings are simply connected to each other, automatically clicking into place and opening the valves.
2. When disconnecting, (one handed operation), the valves are automatically sealed, no leakage occurs.

Hose couplings, 100 % plastic (POM), nw 6.4 mm



Hose couplings, 100 % plastic (POM), nw 6.4 mm, complete						2 weeks
Model	Hose inner dia. mm	Connector type	Nominal width mm	Length mm	Item no.	
coupling, complete, without valve	6.4	hose nozzle	6.4	54	8780-1040	N3
coupling, complete, without valve	9.5	hose nozzle	6.4	54	8780-1060	N3



Hose couplings, 100 % plastic (POM), nw 6.4 mm, male connections, hose nipples with hose nozzles						2 weeks
Model	Hose inner dia. mm	Connector type	Nominal width mm	Length mm	Item no.	
nipple, without valve	6.4	hose nozzle	6.4	36	8782-1040	N3
nipple, without valve	9.5	hose nozzle	6.4	36	8782-1060	N3



Hose couplings, 100 % plastic (POM), nw 6.4 mm, male connections, angled nipples with hose nozzle						2 weeks
Model	Hose inner dia. mm	Connector type	Nominal width mm	Length mm	Item no.	
angled-nipple, without valve	9.5	hose nozzle	6.4	23	8783-1060	N3



Hose couplings, 100 % plastic (POM), nw 6.4 mm, female connections, hose couplings with hose nozzles						2 weeks
Model	Hose inner dia. mm	Connector type	Nominal width mm	Length mm	Item no.	
coupling, without valve	6.4	hose nozzle	6.4	34	8781-1040	N3
coupling, without valve	9.5	hose nozzle	6.4	34	8781-1060	N3



Hose couplings, 100 % plastic (POM), nw 6.4 mm, female connections, hose couplings with conical external thread						2 weeks
Model	Thread	Connector type	Nominal width mm	Length mm	Item no.	
coupling, without valve	3/8" NPT	thread	6.4	35	8783-1062	N3

Rapid couplings, nw 3.2 mm, female connections



Rapid couplings, nw 3.2 mm, female connections, hose couplings with conical external thread

Thread	Material	Model	Length mm	Item no.
1/8" NPT	POM	with valve	26	8740-1122 N3
1/4" NPT	POM	with valve	28	8740-1142 N3
1/4" BSP	POM	with valve	28	8740-1141 N3
1/8" NPT	PP	with valve	26	8740-2022 N3



Rapid couplings, nw 3.2 mm, female connections, hose couplings with hose nozzles

Hose inner dia. mm	Material	Model	Length mm	Item no.
3.2	POM	with valve	42	8741-1202 N3
4.8	POM	with valve	47	8741-1203 N3
6.4	POM	with valve	47	8741-1204 N3
3.2	POM	without valve	42	8741-1002 N3
4.8	POM	without valve	47	8741-1003 N3
6.4	POM	without valve	47	8741-1004 N3
3.2	PP	with valve	42	8741-2002 N3



Rapid couplings, nw 3.2 mm, female connections, hose couplings with hose screw-joint

Hose inner x outer dia. mm	Material	Model	Length mm	Item no.
4 x 6	POM	with valve	44	8742-1104 N3
4 x 6	PP	with valve	44	8742-2004 N3



Rapid couplings, nw 3.2 mm, female connections, for plate mounting with hose nozzle

Hose inner dia. mm	Material	Model	Plate borehole dia. mm	Length mm	Item no.
1.6	POM	with valve	13	36	8743-1101 N3
3.2	POM	with valve	13	42	8743-1102 N3
4.8	POM	with valve	13	47	8743-1103 N3
6.4	POM	with valve	13	47	8743-1104 N3
1.6	PP	with valve	13	36	8743-2001 N3
6.4	PP	with valve	13	47	8743-2004 N3



Rapid couplings, nw 3.2 mm, female connections, for plate mounting with hole screw-joint

Plate borehole dia. mm	Material	Model	Hose inner x outer dia. mm	Length mm	Item no.
13	POM	with valve	4 x 6	44	8744-1104 N3
13	POM	without valve	4 x 6	44	8744-1004 N3
13	PP	with valve	4 x 6	44	8744-2004 N3

Rapid couplings, nw 3.2 mm, male connections



Rapid couplings, nw 3.2 mm, male connections, hose nipples with external thread

Thread	Material	Model	Length mm	Item no.
1/8" NPT	POM	without valve	15	8750-1022 N3
1/8" BSP	POM	with valve	22	8750-1121 N3



Rapid couplings, nw 3.2 mm, male connections, hose nipples with hose nozzles

Hose inner dia. mm	Material	Model	Length mm	Item no.
1.6	POM	without valve	20	8751-1001 N3
3.2	POM	without valve	27	8751-1002 N3
4.8	POM	without valve	32	8751-1003 N3
6.4	POM	without valve	32	8751-1004 N3
1.6	POM	with valve	34	8751-1101 N3
3.2	POM	with valve	42	8751-1102 N3
4.8	POM	with valve	44	8751-1103 N3
6.4	POM	with valve	40	8751-1104 N3
1.6	PP	with valve	34	8751-2101 N3
3.2	PP	with valve	43	8751-2102 N3
6.4	PP	with valve	40	8751-2104 N3



Rapid couplings, nw 3.2 mm, male connections, hose nipple with hose screw-joint

Hose inner x outer dia. mm	Material	Model	Length mm	Item no.
4 x 6	POM	without valve	37	8752-1004 N3
4 x 6	POM	with valve	37	8752-1104 N3
2 x 4	POM	with valve	27	8752-1142 N3
4 x 6	PP	with valve	37	8752-2104 N3



Rapid couplings, nw 3.2 mm, male connections, for plate mounting with hose nozzle

Hose inner dia. mm	Material	Model	Plate borehole dia. mm	Length mm	Item no.
3.2	POM	with valve	13	41	8753-1102 N3
4.8	POM	with valve	13	46	8753-1103 N3
6.4	POM	with valve	13	46	8753-1104 N3



Rapid couplings, nw 3.2 mm, male connections, for plate mounting with hose screw-joint

Hose inner x outer dia. mm	Material	Model	Plate borehole dia. mm	Length mm	Item no.
4 x 6	POM	with valve	13	43	8754-1104 N3



Rapid couplings, nw 3.2 mm, male connections, angled nipples with hose nozzle

Hose inner dia. mm	Material	Model	Length mm	Item no.
3.2	POM	with valve	28	8755-1102 N3
6.4	POM	with valve	28	8755-1104 N3
6.4	PP	with valve	28	8755-2004 N3

Rapid couplings, nw 6.4 mm, female connections



Rapid couplings, nw 6.4 mm, female connections, hose couplings with conical external thread

Thread	Material	Model	Length mm	Item no.
1/4" BSP	POM	without valve	29	8760-1041 N3
1/4" NPT	POM	without valve	29	8760-1042 N3
3/8" BSP	POM	without valve	29	8760-1061 N3
1/4" BSP	POM	with valve	29	8760-1141 N3
1/4" NPT	POM	with valve	29	8760-1142 N3
1/4" NPT	PP	with valve	29	8760-2141 N3
3/8" NPT	PP	with valve	29	8760-2161 N3



Rapid couplings, nw 6.4 mm, female connections, hose couplings with hose nozzles

Hose inner dia. mm	Material	Model	Length mm	Item no.
6.5	POM	without valve	50	8761-1040 N3
8	POM	without valve	50	8761-1050 N3
9.5	POM	without valve	50	8761-1060 N3
6.5	POM	with valve	50	8761-1140 N3
8	POM	with valve	50	8761-1150 N3
9.5	POM	with valve	50	8761-1160 N3
6.5	PP	with valve	50	8761-2140 N3
9.5	PP	with valve	50	8761-2160 N3



Rapid couplings, nw 6.4 mm, female connections, for plate mounting with hose nozzle

Hose inner dia. mm	Material	Model	Plate borehole dia. mm	Length mm	Item no.
6.5	POM	without valve	19	50	8763-1040 N3
8	POM	without valve	19	50	8763-1050 N3
6.5	POM	with valve	19	50	8763-1140 N3
8	POM	with valve	19	50	8763-1150 N3
9.5	POM	with valve	19	50	8763-1160 N3
9.5	PP	with valve	19	50	8763-2160 N3



Rapid couplings, nw 6.4 mm, female connections, hose couplings with hose screw-joint

Hose inner x outer dia. mm	Material	Model	Length mm	Item no.
4 x 6	POM	with valve	47	8762-1140 N3
8 x 10	POM	with valve	50	8762-1310 N3
6 x 8	POM	with valve	50	8762-1380 N3

Rapid couplings, nw 6.4 mm, male connections



Rapid couplings, nw 6.4 mm, male connections, hose nipples with external thread

Thread	Material	Model	Length mm	Item no.
1/4" NPT	POM	with valve	38	8770-1142 N3
1/4" BSP	POM	without valve	32	8770-1041 N3
1/4" NPT	POM	without valve	32	8770-1042 N3
1/4" NPT	PP	with valve	38	8770-2142 N3



Rapid couplings, nw 6.4 mm, male connections, hose nipples with hose nozzles

Hose inner dia. mm	Material	Model	Length mm	Item no.
6.5	POM	without valve	32	8771-1040 N3
8	POM	without valve	32	8771-1050 N3
9.5	POM	without valve	32	8771-1060 N3
6.5	POM	with valve	47	8771-1140 N3
8	POM	with valve	47	8771-1150 N3
9.5	POM	with valve	42	8771-1160 N3
6.5	PP	with valve	47	8771-2140 N3
9.5	PP	with valve	42	8771-2160 N3



Rapid couplings, nw 6.4 mm, male connections, for plate mounting with hose nozzle

Hose inner dia. mm	Material	Model	Plate borehole dia. mm	Length mm	Item no.
6.5	POM	without valve	19	35	8773-1040 N3
9.5	POM	without valve	19	47	8773-1060 N3
6.5	POM	with valve	19	49	8773-1140 N3
8	POM	with valve	19	49	8773-1150 N3
9.5	POM	with valve	19	49	8773-1160 N3



Rapid couplings, nw 6.4 mm, male connections, hose nipple with hose screw-joint

Hose inner x outer dia. mm	Material	Model	Length mm	Item no.
4 x 6	POM	with valve	45	8772-1140 N3
6 x 8	POM	with valve	43	8772-1380 N3
8 x 10	POM	with valve	43	8772-1310 N3
6 x 8	POM	without valve	35	8772-1280 N3



Rapid couplings, nw 6.4 mm, male connections, for plate mounting with hose screw-joint

Hose inner x outer dia. mm	Material	Model	Plate borehole dia. mm	Length mm	Item no.
4 x 6	POM	with valve	19	45	8774-1140 N3
6 x 8	POM	with valve	19	49	8774-1380 N3



Rapid couplings, nw 6.4 mm, male connections, angled nipples with hose nozzle

Hose inner dia. mm	Material	Model	Length mm	Item no.
6.5	POM	without valve	31	8775-1040 N3
9.5	POM	without valve	31	8775-1060 N3
9.5	POM	with valve	31	8775-1160 N3
6.5	PP	with valve	31	8775-2140 N3

Threaded fittings



▶ PP

Hose nozzle with strong outer thread.



▶ Hose nozzle, PP
▶ Seal, EPDM

Hose nozzle with cap nut, inner thread.



▶ PP

Hose angle bracket, 90°, with strong outer thread.



▶ Hose angle bracket, PP
▶ Seal, EPDM

Hose angle bracket, 90°, with cap nut, inner thread and reducing nozzle.

Tube nozzles, fixed, external thread

Thread	Nozzle dia. mm	Nominal width mm	Item no.
3/8"	12	7.5	8545-3812 N3
1/2"	13	8	8545-0012 N3
1/2"	16	10	8545-1216 N3
1/2"	20	13	8545-1220 N3
3/4"	12	7.5	8545-3412 N3
3/4"	16	10	8545-0034 N3
3/4"	20	13	8545-3420 N3
1"	25	19	8545-0100 N3



Tube nozzles, with cap nut

Thread	Nozzle dia. mm	Nominal width mm	Item no.
1/2"	13	9	8546-0012 N3
1/2"	16	10	8546-1216 N3
3/4"	10	6	8546-3410 N3
3/4"	12	7.5	8546-3412 N3
3/4"	13	8.5	8546-3413 N3
3/4"	16	10	8546-0034 N3
3/4"	20	13	8546-3420 N3
1"	25	20	8546-0100 N3



Tube bend, fixed, external thread

Thread	Nozzle dia. mm	Nominal width mm	Item no.
1/2"	12	7.5	8547-0012 N3
1/2"	16	11	8547-1216 N3
1/2"	20	15	8547-1220 N3
3/4"	12	7.5	8547-0034 N3
3/4"	20	15	8547-3420 N3
3/4"	22	17	8547-3422 N3
1"	25	19.5	8547-0100 N3



Tube bend, with cap nut

Thread	Nozzle dia. mm	Nominal width mm	Item no.
1/2"	12	7.5	8548-0012 N3
3/4"	12	7	8548-3412 N3
3/4"	16	11	8548-0034 N3
3/4"	20	15.5	8548-3420 N3
1"	25	19.5	8548-0100 N3



Threaded fittings



▶ PP

Hose angle bracket, 90°, with cap nut, inner thread and reducing nozzle.

Tube bend, with cap nut, white

Thread	Outlet dia. mm	Nominal width mm	Item no.
M29x1,75	9	15	8548-0020 N3
M36x3	10	20	8548-0025 N3
M42x3	11	25	8548-0030 N3



▶ PP

Container connector with outer thread, complete with EPDM seals, for easy mounting of thread in the sides of containers.

Container connection, white

Thread	Nominal width mm	Item no.
1/2"	13,5	8533-0012 N3
3/4"	18	8533-0034 N3
1"	24	8533-0100 N3



Hexagonal nut with inner thread.

Hexagonal nuts

Thread	Material	Item no.
1/2"	HDPE	8537-0012 N3
3/4"	HDPE	8537-0034 N3
1"	HDPE	8537-0100 N3
2"	PP	8537-0200 N3



▶ PE

Flat seals made of Polyethylene, transparent fitting outer or inner thread.

Flat seals, PE

Thread	Model	Pieces per pack	Item no.
1/2"	fits outer thread	10	8538-0012 N3
3/4"	fits outer thread	10	8538-0034 N3
1"	fits outer thread	10	8538-0100 N3
2"	fits outer thread	10	8538-0200 N3
1/2"	fits inner thread	10	8539-0012 N3
3/4"	fits inner thread	10	8539-0034 N3
1"	fits inner thread	10	8539-0100 N3

Threaded fittings

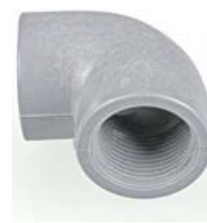

Socket with inner thread.

Nipple with outer thread.

Angle bracket 90° with inner thread.

► PP

► PP

► PP

Socket, inner thread



Thread	Nominal width mm	Item no.	
1/2"	19	8501-0012	N3
3/4"	23	8501-0034	N3
1"	28.5	8501-0100	N3

Nipple, outer thread



Thread	Nominal width mm	Item no.	
1/2"	13.5	8505-0012	N3
3/4"	18	8505-0034	N3
1"	23.5	8505-0100	N3

90° bend, inner thread



Thread	Nominal width mm	Item no.	
1/2"	17.5	8515-0012	N3
3/4"	23	8515-0034	N3
1"	28.5	8515-0100	N3



Socket, reduced with inner thread.

Nipple, reduced, with outer thread.

Angle bracket 90° with inner / outer thread.

► PP

► PP

► PP

Socket, reduced

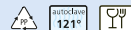

Thread	Nominal width mm	Item no.	
1/2" - 3/4"	17.5	8502-1234	N3
3/4" - 1"	23	8502-3410	N3

Nipple, reduced



Thread	Nominal width mm	Item no.	
1/2" - 3/4"	13.5	8506-1234	N3
3/4" - 1"	18	8506-3410	N3

90° bend, inner/outer thread



Thread	Nominal width mm	Item no.	
1/2"	14	8516-0012	N3
3/4"	19	8516-0034	N3
1"	24.5	8516-0100	N3

Threaded fittings



T piece with inner thread.

► PP

T-piece			
Thread	Nominal width mm	Item no.	
1/2"	17.5	8525-0012	N3
3/4"	23	8525-0034	N3
1"	28.5	8525-0100	N3



Tube extension with outer thread. 8520-0012, -0034 length 152 mm, 8520-0100 length 162 mm.

► PP

Tube extensions			
Thread	Nominal width mm	Item no.	
1/2"	12.5	8520-0012	N3
3/4"	18	8520-0034	N3
1"	23.5	8520-0100	N3



Container connector with outer thread, complete with EPDM seals, for easy mounting of thread in the sides of containers.

► PP

Container connection			
Thread	Nominal width mm	Item no.	
1/2"	13.5	8530-0012	N3
3/4"	18	8530-0034	N3
1"	24	8530-0100	N3

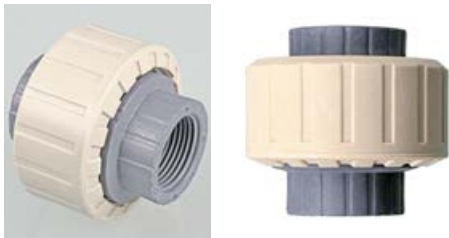

Screw joint with inner thread, enables easy disconnection of tube connections.

► PP

Screw joint			
Thread	Nominal width mm	Item no.	
1/2"	17.5	8510-0012	N3
3/4"	21.5	8510-0034	N3
1"	26.5	8510-0100	N3



Closing cap with inner thread.

► PP

Cap			
Thread	Nominal width mm	Item no.	
1/2"	12.5	8535-0012	N3
3/4"	18	8535-0034	N3
1"	23.5	8535-0100	N3



Threaded cap outer thread.

► PP

Stopper			
Thread	Nominal width mm	Item no.	
1/2"	12.5	8536-0012	N3
3/4"	18	8536-0034	N3
1"	23.5	8536-0100	N3

VacuMan vacuum pump

Hand pump can be operated with one hand to create a vacuum or pressure, independent of a power supply (e.g. vacuum filtration, taking samples, dissipation of desiccators). Maintenance-free, self-lubricating, mainly corrosion resistant. Connection for hoses with 6.4 mm inner Ø. Available in PVC or aluminium for heavy duty.



- ▶ With or without gauge
- ▶ Sampling set with suction hose and sample container and adapter set for hoses from 5 to 14 mm available as accessory



- ▶ With gauge
- ▶ Adapter set for hoses from 5 to 14 mm available as accessory

VacuMan vacuum pump

Pressure gauge	Stroke approx. ml	Material	Vacuum mbar	Item no.	
no	32	PVC	- 850	5620-0360	N3
yes	16	PVC	- 850	5620-1180	N3
yes	32	PVC	- 850	5620-1360	N3

Accessories

Description	Item no.
Adapter set for hoses from 5 to 14 mm	5620-0010 N3
Sampling set with suction hose and sample container	5620-0020 N3

VacuMan vacuum or pressure pump

Pressure gauge	Material	Stroke approx. ml	Vacuum mbar	Pressure max. bar	Item no.
yes	PVC	16	- 850	+ 2	5620-2180 N3
yes	aluminium	16	- 850	+ 2	5620-2181 N3

Accessories

Description	Item no.
Adapter set for hoses from 5 to 14 mm	5620-0010 N3
Sampling set with suction hose and sample container	5620-0020 N3

Water-jet pump



- ▶ PP, PTFE, FKM
- ▶ Continuous use temperature max. 80 °C
- ▶ Incl. reducing piece to 1/2"

The water jet pump is used for withdrawing liquids and gases, and for creating a vacuum. Simple operation and easy cleaning. Very low water consumption, constant pressure and high suction. Suction tube connection: Olive 6 – 9 mm outer Ø, screw cap GL 14. Water consumption at 3.5 bar flow pressure and 12 °C water temperature: approx. 190 l/hour at 3.5 bar (absolute). 6 l of water are needed to evacuate a 1 l pressure vessel from normal pressure to final pressure. Suction capacity at 3.5 bar flow pressure and 12 °C water temperature: 400 l/h evacuation time for a 1 l pressure vessel from normal pressure to 100 mbar: 60 sec. (± 10 sec.). Final pressure at 3.5 bar flow pressure and 12 °C water temperature: < 16 mbar.

The vacuum connection can be unscrewed and supplied adapters provide a variety of connection options to the water supply.

Water-jet pump

Item no.	
9668-0200	N3
Accessories	
Description	Item no.
Reducing adapter 3/8"	9668-0010 N3
Reducing adapter M 22 x 1 (perlator thread)	9668-0011 N3

AirJet Mini membrane vacuum pump



The AirJet Mini single-head membrane vacuum pump is suitable for a variety of applications in the laboratory and industry. The dry running membrane vacuum pump is able to pump, compact and evacuate 100 % oil-free, which means it does not distort results or add impurities, and can also be used as a compressor. The AirJet Mini is used to pump and evacuate air and neutral or slightly aggressive or corrosive gases and vapours.

- ▶ Weight 1.9 kg, dimensions LxWxH 164/90/141 mm
- ▶ Hose connection ID 4 mm
- ▶ Maintenance-free, environmentally friendly
- ▶ High level of gas tightness
- ▶ Very quiet with low vibrations

Attention! Make sure to pay attention to the "List of Chemical Resistance"!



① AirJet Mini membrane vacuum pump/compressor



Model	Pump capacity approx. l/min	Vacuum mbar	Pressure max. bar	Item no.
Membrane made of EPDM	6	100	2.4	5625-2000 N2
Membrane made of PTFE	5.5	160	2.5	5625-2001 N2

Accessories

Description	Item no.
② AirJet Mini fine regulation head	5625-2002 N2
③ AirJet Mini sound absorber	5625-2003 N2

Desiccator



Desiccators made of plastic, break resistant, lightweight and suitable for vacuums. Stopcock suitable for vacuums up to -740 mmHg. Base and desiccator plate made out of Polypropylene. Lid is crystal clear Polycarbonate with a non-return valve and a venting valve. O-ring seal made of Polychlorobutadiene-rubber. Continuous temperature max. +60 °C.

- ▶ Hose connection fits hoses with inner Ø 8.5 mm
- ▶ Delivery incl. O-ring
- ▶ Perforated plate and additional O-rings available as accessories

Desiccator

Inner dia. mm	Outer dia. mm	Height mm	Item no.
150	175	190	9791-0150 N3
200	235	230	9791-0200 N3
250	285	300	9791-0250 N3

Accessories

Description	Item no.
Perforated plates for desiccator for i.d. 150 mm	9791-0151 N3
Perforated plates for desiccator for i.d. 200 mm	9791-0201 N3
Perforated plates for desiccator for i.d. 250 mm	9791-0251 N3
O-ring for desiccator for i.d. 150 mm	9791-0152 N3
O-ring for desiccator for i.d. 200 mm	9791-0202 N3
O-ring for desiccator for i.d. 250 mm	9791-0252 N3

Mercury collector



Bürkle's mercury collector enables the easy collection of spilt mercury, which can then be used again. The mercury collector is composed of a tub with a screw cap lid that has a special plastic foam inserted. On pressing this foam gently on the spilt mercury, the foam's pores are opened and the mercury globules are absorbed. The cap is then screwed on the tub, the globules are released again and fall through the perforated separation into the tub.



Mercury collector

Item no.
9789-0001 N4

Accessories

Description	Item no.
Spare plastic foam insert for mercury collector	9789-0002 N4

Eyes Fresh mini eyewash station



Mini eyewash station ideal for the lab, filling stations or all work places where aggressive substances are used. Eyes Fresh can be attached to any standard cold water tap. For normal use of the tap, just press the button and the function changes back from the eye wash (returns automatically to eyewash-function when the tap is closed). Can be fitted onto taps with M22x1, 1/2" or 3/8" outer thread. With sufficient water pressure provided, performance according to DIN EN 15154-2.

Eye rinsing bottle



Empty bottle for 600 ml contents, leakproof due to valve and dust protection cap. Instructions printed on, made of transparent PE.

Eyes Fresh mini eyewash station



Model	Item no.
Press button for normal use	2515-0100 N4

Eye rinsing bottle



Item no.	
2507-2000	N3

Wall fixture

Item no.	
2507-2001	N3

HotGrip



Hand protection made of silicone rubber highly resistant to cold and heat. Protects fingers and hands from burns and freezing when working with apparatus which has extreme temperatures. HotGrip is resistant to temperatures from $-50\text{ }^{\circ}\text{C}$ to $+200\text{ }^{\circ}\text{C}$ (briefly up to $+250\text{ }^{\circ}\text{C}$). Deep frozen, hot or even boiling substances and apparatus can be safely handled and positioned. Silicone rubber is extremely elastic and slip-proof, so that even smooth surfaced apparatus such as hot glass flasks can be securely gripped.

HotGrip

Model	Colour	Item no.	
for the whole hand	red	9768-0001	N3
for thumb and one finger	white	9768-0002	N3
for thumb and 2 to 3 fingers	white	9768-0003	N3



Rubiflex protective gloves



With short or long gauntlet. Safe working with fats, mineral oils, solvents and many acids and alkalis.

- ▶ Made from nitrile rubber
- ▶ Very flexible, soft to the touch
- ▶ High abrasion and cut resistance
- ▶ Comfortable cotton interlock interior
- ▶ To standard EN 374



Attention! Make sure to pay attention to the "List of Chemical Resistance"!

Rubiflex protective gloves

Model	Length cm	Item no.
standard	37	2507-0002 N3
long wrist	60	2507-0003 N3



Standard bungs silicone



The bungs are transparent, chemically-biologically neutral, food-safe according to BfR Recommendation XV and FDA § 177.2600.

- ▶ Temperature resistant from -60 °C to +200 °C, briefly to +230 °C
- ▶ Sterilisable
- ▶ Non-toxic

Standard bungs silicone rubber



Dia. bottom mm	Dia. top mm	Height mm	Item no.
5	9	20	9764-0610 N3
8	12	20	9764-0913 N3
10.5	14.5	20	9764-1115 N3
14	18	20	9764-1418 N3
17	22	25	9764-1621 N3
18	24	30	9764-1924 N3
21	27	30	9764-2227 N3
26	32	30	9764-2531 N3
29	35	30	9764-2834 N3

Standard bungs



Laboratory standard bung made of PVC with good chemical resistance against acids and alkalis.

- ▶ PVC, soft, red



! Attention! Make sure to pay attention to the "List of Chemical Resistance"!

Standard bungs



Dia. bottom mm	Dia. top mm	Height mm	Item no.
7	10	18	9763-0610 N3
9	13	20	9763-0913 N3
11	15	20	9763-1115 N3
14	18	20	9763-1418 N3
16	21	24	9763-1621 N3
19	24	25	9763-1924 N3
22	27	24	9763-2227 N3
25	31	29	9763-2531 N3
28	34	30	9763-2834 N3
31	38	33	9763-3138 N3
34	41	35	9763-3441 N3
42	49	34	9763-4249 N3
46	53	39	9763-4654 N3

Bungs PE



Stopper made of PE, hollow with sealing rings and octagonal top.

- ▶ PE

Bungs PE



GGJ	Dia. bottom mm	Dia. top mm	Item no.
7/16	5.9	7.5	9760-0716 N3
10/19	8.2	10	9760-1019 N3
12/21	10.4	12.5	9760-1221 N3
14/23	12.1	14.5	9760-1423 N3
19/26	16.4	19	9760-1926 N3
24/29	21.1	24	9760-2429 N3
29/32	25.8	29	9760-2932 N3
34/35	31	34.5	9760-3435 N3
45/40	41	45	9760-4045 N3



Disposable laboratory equipment

- ▶ Scoops, from page 124
- ▶ Ladles, from page 126
- ▶ Spatulas, from page 127
- ▶ Spoons, from page 128
- ▶ Dosing spoons, from page 130
- ▶ Forceps, from page 130
- ▶ Scrapers, from page 131
- ▶ Palette knife spatula, from page 131
- ▶ Funnels, from page 132
- ▶ Micro-spatulas, page 152
- ▶ Spoon spatulas, page 153



Stainless Steel laboratory instruments

- ▶ Spatulas, from page 88
- ▶ Palette knife spatula, page 88
- ▶ Forceps, page 151
- ▶ Micro-spatulas, page 152
- ▶ Spoon spatulas, page 153
- ▶ Dosing spoons, from page 154
- ▶ Sample-spoon, page 155
- ▶ Scoops, from page 156



Magnetic stirring bars



Cylindrical stirring bars with smooth surface, many uses.

- ▶ PTFE opaque
- ▶ Max. use temperature +270 °C
- ▶ High performance permanent magnets and long lifespan

Magnetic stirring bar set consists of 10 of the most standard bars, complete with crystal clear box.

- ▶ 1 of each 15 x 6 mm, 30 x 7mm
- ▶ 2 of each 20 x 7mm, 25 x 6 mm, 40 x 7 mm, 50 x 7 mm

Magnetic stirring bars

Length mm	Dia. mm	Item no.	
15	6	8271-1506	N3
20	6	8271-2006	N3
20	7	8271-2007	N3
25	6	8271-2506	N3
30	6	8271-3006	N3
30	7	8271-3007	N3
40	7	8271-4007	N3
40	8	8271-4008	N3
50	7	8271-5007	N3
50	8	8271-5008	N3
80	10	8271-8010	N3

Magnetic stirring bar set

Model	Item no.	
set incl. ten bars	8271-1000	N3

Stirring paddle



Stirring paddle made of polypropylene for gentle stirring in plastic and glass containers.

- ▶ PP
- ▶ Shatterproof
- ▶ Warp resistant
- ▶ Total length 1,17 m or 1,71 m



Stirring paddle

Length mm	Width mm	Total length cm	Item no.
155	130	117	8203-2100 N3
190	167	171	8203-3150 N3

Chemical resistance

Chemicals	Formula	CAS-No.	Concentration	Hazard note	Inflammable	Plastics																							
						HDPE	LDPE	PA	PC	PETG	PMP	POM	PP	PS	PSU	PVC HARD	PVC SOFT	SAN	ECTFE/ETFE	FEP	PTFE	PVDF	EPDM	FPIM/FKM	NBR	SI	AL	AISI 304	AISI 316 L
Acetone	C ₃ H ₆ O	000067-64-1		F, Xi	X	1/1	3/3	1/0	4/4	4/4	2/3	1/3	1/3	4/4	4/4	4/4	0/0	4/4	2/3	(1)	1/1	3/4	1/4	4/4	4/4	0/0	1/1	1/1	1/1
Calcium chloride	CaCl ₂	010043-52-4	aqueous	Xi		1/1	1/1	1/0	1/0	1/0	1/1	(3)	1/1	1/1	1/0	1/3	1/0	1/1	1/1	1/1	1/1	1/1	1/0	1/1	1/1	0/0	3/3	1/2L	1/2L
Chlorine	Cl ₂	007782-50-5	10 % wet	T		3/4	3/4	4/4	2/3	4/4	2/4	4/4	4/4	4/4	4/4	1/2	0/0	4/4	1/1	1/1	(2)	2/0	3/0	4/4	0/0	4/4	4/4	4/4	
Chloroform	CHCl ₃	000067-66-3	100 %	Xn		3/4	4/4	3/4	4/4	4/4	4/4	4/4	3/4	4/4	4/4	4/4	4/4	4/4	2/3	1/1	1/1	1/1	4/4	3/4	4/4	0/0	(3)	1/1	1/1
Developer for fotos	—	—		?		1/3	1/1	4/4	(2)	1/0	0/0	1/3	1/2	0/0	1/0	1/3	1/0	0/0	0/0	(1)	1/1	1/1	3/0	1/0	1/0	0/0	1/1	1/0	1/0
Ethyl alcohol	C ₂ H ₆ O	000064-17-5	96 %	F	X	1/0	1/3	1/0	1/3	1/1	1/2	1/2	1/1	3/4	1/2	1/3	3/0	1/3	1/1	1/1	1/1	1/0	3/0	3/3	0/0	1/1	1/1	1/1	
Formaldehyde solution	CH ₂ O	000050-00-0	40 %	T		1/2	2/3	1/3	1/2	1/0	1/2	1/2	1/2	4/4	2/3	2/3	3/3	0/4	1/1	1/1	1/1	1/1	1/0	3/0	(3)	0/0	1/1	1/1	1/1
Formic acid	CH ₂ O ₂	000064-18-6	98-100 %	C		1/1	1/2	4/4	3/4	0/0	1/3	4/4	1/3	3/4	3/3	3/4	1/3	3/4	1/1	(1)	1/1	1/1	3/4	4/4	4/4	0/0	1/0	1/3	1/2
Fuel oil	—	—		Xn		3/3	3/4	1/0	3/3	1/0	2/3	1/1	1/3	3/4	1/2	1/1	3/3	1/1	1/1	1/1	1/1	1/1	4/4	1/1	1/1	0/0	1/1	1/1	1/1
Gasoline	C ₈ H ₁₂ -C ₁₂ H ₂₆	086290-81-5		F, Xn, N	X	2/3	3/4	1/0	3/3	(2)	2/3	1/2	3/4	4/4	3/3	2/4	0/0	0/4	1/1	1/1	1/1	4/4	(1-3)	3/0	0/0	1/1	1/1	1/1	
Hydrogen chloride	HCl	007647-01-0	35 %	C		1/1	1/1	4/4	4/4	(4)	1/2	4/4	1/2	3/3	1/1	2/3	3/3	1/3	1/1	1/1	1/1	1/1	3/0	1/2	4/4	0/0	4/4	4/4	4/4
Hydrogen fluoride	HF	007664-39-3	70 %	T+, C		0/0	1/3	4/4	4/4	4/4	0/0	4/4	1/3	4/4	4/4	1/4	3/0	0/0	0/0	(1)	1/1	1/1	3/4	(3)	4/4	0/0	4/4	4/4	4/4
Isopropyl alcohol	C ₃ H ₈ O	000067-63-0	techn. pure	F	X	1/1	1/1	1/0	1/2	1/0	1/2	1/0	1/1	2/2	1/2	1/2	4/4	1/4	1/1	1/1	1/1	1/0	1/1	3/3	0/0	(2)	(1)	(1)	
Methyl ethyl ketone (MEK)	C ₄ H ₈ O	000078-93-3		F	X	1/3	3/4	1/0	4/4	4/4	4/4	1/2	1/3	4/4	4/4	4/4	4/4	2/3	1/1	1/1	3/4	3/0	4/4	4/4	0/0	(1)	(1)	(1)	
Nitric acid	HNO ₃	007697-37-2	50 %	C+		2/4	3/4	4/4	4/4	(2)	2/4	4/4	3/4	4/4	2/3	2/3	0/0	0/3	1/1	1/1	1/1	1/1	4/4	1/0	4/4	0/0	4/4	1/2	1/2
Nitrohydrochloric acid	HNO ₃ + HCl	008007-56-5		C		4/4	4/4	4/4	4/4	4/4	3/3	4/4	4/4	4/4	4/4	4/4	4/4	3/4	1/1	(2)	1/1	3/0	4/4	4/4	0/0	4/4	4/4	4/4	
Phosphoric acid	H ₃ PO ₄	007664-38-2	85 %	C		1/1	1/1	4/4	1/2	0/0	1/2	4/4	1/2	1/2	1/1	1/2	1/1	1/2	1/1	1/1	1/1	1/1	4/4	1/1	4/4	0/0	4/4	2/4	1/3
Sodium hydroxide	NaOH	001310-73-2	50 %	C+		1/1	1/1	1/0	4/4	4/4	1/1	1/3	1/1	2/2	1/1	1/2	0/0	0/3	1/1	1/1	1/1	3/3	1/0	3/4	3/3	0/0	4/4	1/3	1/3
Spirits of Turpentine	—	008006-64-2		Xn	X	2/2	3/4	1/0	4/4	1/0	3/3	1/1	4/4	4/4	4/4	2/3	4/4	3/3	1/1	1/1	1/0	1/3	4/4	1/1	3/3	0/0	4/4	1/1	1/1
Sulfuric acid	H ₂ SO ₄	007664-93-9	95 %	C+		3/4	3/4	4/4	4/4	4/4	2/2	4/4	3/4	4/4	4/4	2/4	0/0	4/4	1/1	1/1	1/1	1/1	4/4	1/1	4/4	0/0	4/4	1/3	1/3
Tetrachloroethylene	C ₂ Cl ₄	000127-18-4		Xn		4/4	4/4	4/4	4/4	3/4	4/4	1/3	4/4	4/4	4/4	4/4	4/4	3/3	1/1	1/1	1/1	4/4	2/3	4/4	0/0	(3)	0/0	0/0	
Trichloroethylene (TRI)	C ₂ HCl ₃	000079-01-6	100 %	Xn		3/4	4/4	3/0	4/4	4/4	4/4	4/4	4/4	4/4	4/4	4/4	4/4	0/4	1/2	1/1	1/0	1/1	4/4	1/3	4/4	0/0	1/3	1/1L	1/1L
Vinegar	C ₂ H ₄ O ₂	000064-19-7		(Xi)		1/1	1/3	4/4	1/2	1/1	1/0	1/3	1/1	1/0	1/0	1/0	3/0	1/1	1/1	1/1	1/1	1/0	3/3	3/3	0/0	1/3	1/2	1/2	
Xylene	C ₈ H ₁₀	001330-20-7		(F), Xn	X	3/4	3/4	1/0	4/4	0/0	3/4	1/2	4/4	4/4	4/4	4/4	4/4	4/4	1/2	1/1	1/0	1/3	4/4	1/3	4/4	0/0	1/1	1/1	1/1

Two values are given per substance, left number = value at + 20 °C, right number = value at + 50 °C.

1 = resistant, 2 = practically resistant, 3 = partially resistant, 4 = not resistant, 0 = no data available.

K = no general information available; L = danger of pitting or stress-cracking corrosion, values in parentheses are estimated values.

Hazard notes: C = caustic; F = inflammable; F+ = highly inflammable; O = fire-promoting; T = poisonous; T+ = very poisonous; Xn = slightly poisonous; Xi = irritant

Important note

The tables headed "Chemical resistance of plastics" and "Properties of plastics materials" have been compiled from information from various producers of raw materials. The figures relate exclusively to laboratory tests on raw materials.

Plastics items made from these materials are often subject to influences which cannot be detected in a laboratory test (temperature, pressure, stresses in the material, chemical substances, design features, etc.). For these reasons the figures quoted can serve only as a guideline. In case of doubt we strongly recommend that a test be carried out. No legal claims can be derived from these figures and we disclaim all liability. The chemical and mechanical resistance of a product does not suffice for the assessment of its suitability for use, for example legislation on flammable liquids (explosion protection) is to be taken into particular consideration.

Detailed table can be downloaded free of charge

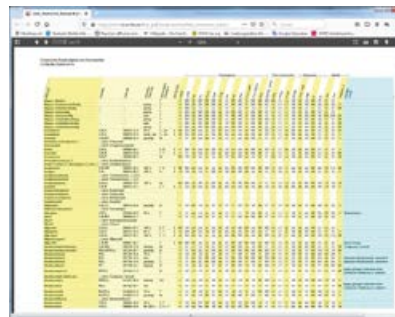

- ▶ More than 1600 media
- ▶ With viscosity table
- ▶ CAS numbers
- ▶ Simple operation
- ▶ Free of charge
- ▶ Download address: www.buerkle.de/en/chemical-resistance

Plastics technology | overview of chemical resistance

EPDM	Ethylene propylene diene monomer	PA	Polyamide	PSU	Polysulfone
FEP	Fluorinated ethylene-propylene (Teflon, FEP)	PC	Polycarbonate	PTFE	Polytetrafluoroethylene
PETG	Polyethyleneterephthalate	PFA	Perfluoro-alkoxy (Teflon, PFA)	PVC	Polyvinylchlorid
FPM/FKM	Fluoroelastomer (Viton)	PMP	Polymethylpentene (TPX)	PVDF	Polyvinylidene fluoride
HDPE	High-density polyethylene	PP	Polypropylene	SAN	Styrene-acrylnitrile
LDPE	Low-density polyethylene	PS	Polystyrene	SI	Silicone rubber

Plastics abbreviations	Temperature		steam ⁴⁾ 121°C	Sterilization ⁵⁾ radiation 2.5 kGy			chemical formalin, ethanol	Transparency	Flexibility	Specific weight g/cm ³	Water absorption %
	max. ₁₎ °C	min ₂₎ °C		gas ethyleneoxide	yes	no					
EPDM	+ 120°	- 30°	yes	no	yes	yes	yes	transparent	excellent	0.88	0.01
FEP	+ 205°	- 255°	yes	yes	no	yes	yes	transparent	very good	2.15	< 0.01
FPM	+ 200°	- 20°	no	no	no	no	no	black	good	1.90	0.20
HDPE	+ 110°	- 50°	no	yes	yes	yes	yes	transparent	stiff	0.95	0.01
LDPE	+ 95°	- 50°	no	yes	yes	yes	yes	transparent	excellent	0.92	0.01
PA	+ 90°	0°	no	yes	yes	yes	yes	transparent	stiff	1.13	1.30
PC	+ 135°	- 135°	yes	yes	yes	yes	yes	clear	rigid	1.20	0.35
PFA	+ 250°	- 270°	yes	yes	no	yes	yes	transparent	excellent	2.15	0.03
PMP	+ 175°	- 150°	yes	yes	yes	yes	yes	glass-clear	stiff	0.83	0.01
PP	+ 135°	+ 5°	yes	yes	no	yes	yes	transparent	stiff	0.90	0.02
PS	+ 70°	- 20°	no	no	yes	yes	yes	glass-clear	stiff	1.05	0.05
PSU	+ 165°	- 100°	yes	yes	yes	yes	yes	clear	stiff	1.24	0.30
PTFE	+ 270°	- 270°	yes	yes	no	yes	yes	white	excellent	2.25	< 0.01
PVC	+ 70°	- 30°	no ³⁾	yes	no	yes	yes	clear	stiff	1.35	0.06
PVDF	+ 160°	- 40°	yes	yes	yes	yes	yes	transparent	stiff	1.78	0.04
SAN	+ 95°	- 40°	no	yes	no	yes	yes	glass-clear	stiff	1.03	0.05
SI	+ 180°	- 60°	yes	yes	no	yes	yes	transparent	excellent	1.10	n/a
PETG	+ 70°	+ 5°	no	yes	yes	yes	yes	glass-clear	stiff	1.78	0.70

¹⁾ Even higher for short periods

²⁾ Brittle temperature

³⁾ Except PVC hoses, which can be sterilised with steam at a temperature of 121 °C

⁴⁾ Frequent steam sterilization reduces mechanical stability!

⁵⁾ Clean apparatus with distilled water first (to avoid stress cracking corrosion). In the case of closed vessels, remove or slightly open lid, do not close lid tight again until the vessel has cooled down.

Substance class at 20 °C	ABS	ECTFE	HDPE	LDPE	PA	PC	PMP	PP	PS	PTFE/FEP/PFA	PVC	SAN	SI
Aldehydes	-	+	+	+	0	0	0	+	-	+	-	-	0
Alcohols aliphatic	+	+	+	+	0	+	+	+	+	+	+	+	+
Esters	-	+	0	0	+	-	0	0	-	+	-	-	0
Ethers	-	+	0	-	+	-	-	-	-	+	-	-	-
Ketones	-	0	0	0	+	-	0	0	-	+	-	-	-
Carbohydrates													
aliphatic	-	+	+	0	+	0	0	+	-	+	+	-	-
aromatic	-	+	+	0	+	-	-	0	-	+	-	-	-
halogenated	-	+	0	-	0	-	-	0	-	+	-	-	-
Acids, weak/dilute	0	+	+	+	0	0	+	+	0	+	+	0	0
Acids, strong/concentrated	-	+	+	+	-	-	+	+	0	+	+	-	-
Acids, oxidising	-	0	0	0	-	-	0	0	-	+	-	-	-
Bases	0	+	+	+	0	-	+	+	-	+	+	+	+

+ = excellent chemical resistance

The substance does not result in any damage to the plastic after 30 days of permanent contact. The plastic may remain resistant for years.

0 = good/limited chemical resistance

Within 7 to 30 days of permanent contact, the substance provokes minor damage which may be reversible (softening, swelling, reduction of mechanical strength, discolourations).

- = low chemical resistance

Not suitable for permanent contact with this substance. Damage to the plastic may occur immediately (reduction of mechanical strength, deformation, discolourations, splits, dissolution, risk of breakage).

Suitable thread adapters | for many container threads

Plastic barrels and containers can have a wide range of thread types. Some are standardized according to DIN, BSI or US standards. Other threads are manufacturer-specific. We can supply suitable adapters for most containers so that discharge valves, pumps and other accessories can be safely attached.

Various steps are necessary in order to select the correct adapter. Proceed as follows:

1. First use the thread table to select the container thread.

If possible use calipers for the measurement, although most threads can be measured accurately enough with a ruler.

If your container has an outer thread you will require an adapter with an inner thread. Containers with an inner thread require adapters with an outer thread.

2. In the Adapter overview on page 27 you will find the suitable adapter.

All thread descriptions refer directly to the adapter. This means that if your container has a $\frac{3}{4}$ " outer thread you will require an adapter with a $\frac{3}{4}$ " inner thread. If you cannot find the necessary adapter here, or if you cannot determine the thread size, just send us a screw cap and we will send you a suitable adapter.



Example

Your container thread is an outer thread with a diameter of 71 mm. You want to use a PP barrel pump with a barrel screw joint. Use the thread table to determine the type of thread. As it is a 71 mm thread you will require an adapter with a 71 mm inner thread. The barrel screw joint thread is 2" BSP outer. This means that you need an adapter from 71 mm inner to 2" BSP inner. In the Adapter table on page 27 you will then find the corresponding article number 0600-1003.

- 12 35 mm - 2" BSP
- 13 40 mm - 2" BSP
- 14 51 mm - 2" BSP
- 15 DIN 61 - 2" BSP
- 16 63 mm - 2" BSP
- 17 DIN 71 - 2" BSP

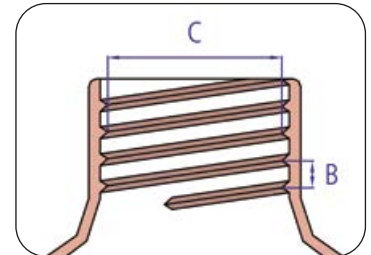
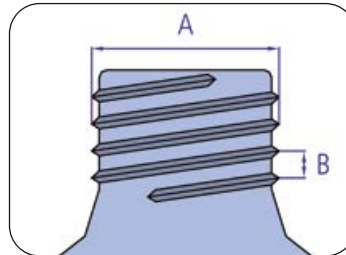

Threads overview

A mm	B mm	C mm	Thread description	Thread type
53	5	50,5	51 mm, DIN 51*)	sawtooth
59-60	6	55,8	60 mm, DIN 60, S60	sawtooth
61	6	55,8	61 mm, DIN 61, S60	sawtooth
71	6	66,5	71 mm, DIN 71	sawtooth
59	2,2	57,5	2" BSP/R2" steel drum fine thread	sawtooth
64,5	5	60	63 mm, 64 mm BSI	sawtooth
33,5	3	32,7	35 mm	round/std.
69,5	5,5	65	2" coarse thread Mauser L-Ring, S70	sawtooth
56	3,5	52,5	Tri-Sure/2" coarse thread v. Leer/Tri-sure, S56	sawtooth
63,2	4,25	57,5	US drum thread	sawtooth

*) old and alternative thread names are printed semibold

Packaging containers with UN approval

What is a container with UN approval?

The person who fills a package with hazardous materials is responsible for its safety on dispatch. In a UN approved container you can transport hazardous goods safely without having to repack them and thus save costs.

What is "UN-approved"?

The UN has drawn up a list of more than 6000 hazardous substances classified according to the risk that they represent; this determines their packaging group. Packaging group I (X) corresponds to a high degree of risk represented by the contents, e.g. very corrosive substances; packaging group II (Y) a medium degree of risk and packaging group III (Z) less hazardous substances.

The UN approval describes the type of packaging to be used for the transport of hazardous substances. The certificate is issued by recognized material testing institutes. In mass production the manufacturer must guarantee that the product meets the specifications for the type of packaging and that the packaging is manufactured and tested according to a quality assurance program recognized and monitored by the registration office.

Test criteria (limits must not be infringed)

- ▶ chemical compatibility
- ▶ temperature
- ▶ flash point < 61 °C
- ▶ drop height
- ▶ pressure (i.e. vapor pressure of the contents plus partial pressure of any gases that may be present)
- ▶ packaging groups I, II, III (density kg/l)
- ▶ shelf life from filling date (if applicable)

Approval numbers

- ▶ The identification contains the symbol for UN-tested packaging, the code for the container material, packaging group, test pressure in kPa, year of manufacture, country of approval, registration office, approval number and manufacturer.
- ▶ If the approval number contains a letter (e.g. F or S) in the position that would otherwise be occupied by the test pressure in kPa then the packaging is only approved for use with solids, not with liquids.
- ▶ New approval numbers apply for all types of transport, i.e. there is no longer any limitation to road, rail, sea or air transport.

Pictograms

	Material
	Ultra-pure material
	Translucent
	Glass-clear material
	Material impermeable to light
	Manufactured from renewable raw materials
	Suitable for use with foodstuffs
	Exceptional temperature-resistance
	Autoclavable up to max 121 °C 20 min.
	Product is sterilised
	Cap absolutely tight closing
	Observe explosion protection guidelines
	UN approved
	Produced according to DIN norm
	Produced according to CE guidelines
	Warranty period
	Unusual delivery period
	Attention! Important information
	General information
	Required accessory
	Optional accessory



1B1 / X / 250 / 15 / D / BAM 1234 XYZ

Symbol for UN-tested packaging

Code for the container material

Packaging group

Test pressure in kPa

Year of manufacture and country of approval

Registration office, approval number and manufacturer

A			
Accessories for zone samplers	62	Bottle, Wash	186
AccuOne / EnergyOne	32	Bottle, Wide-necked	178
Adapter set Pump-it®	12	Bowls sterilisable	219
AISI 304, Scoop	156, 157	Bowl stainless steel, deep form	218
All-layer drill	64	Bowl stainless steel, shallow form	218
All-layer sampler	61	Bucket HDPE	223
All-layer-scratcher	65	Bucket made of PP	223
All-purpose boxes, round	192	Buckets	222, 223
All-purpose trays	214	Buckets, Packaging	210, 221
Aluminium bottle	167, 188	Bucket, stainless steel	221
Aluminum sampler	104	Bungs PE	275
Angled connectors	248	Burettes	234
Anti-static set	25	C	
Apron, Plastic	51	Cables, Lowering	112
AquaSampler	111	Canisters	200
Assistants, Pipette	238	Carrier box, Bottle	187
B			
Ball valve PP	44	Cheese sampler	87
Ball valve PP, food	45	Chemistry scoop	94
Ball valves for barrels	44	CheMobil	252
Barrel key	50	ChemoSampler	99
Barrel pump made of stainless steel	19	Clamps, Hose	254
Barrel pump PP	16	close-it control seal	78, 79
Barrel pumps, Gas-tight	28	close-it dispenser	83
Barrel pumps, PTFE	15	close-it food	80
Barrel pump, Stainless steel	18	close-it tape	81
Barrel screw joints	26	Compact jerrycan	196, 197
Battery-powered Hose pump	101	Compact jerrycan & Compact stop cock set	42
Beaker, Angular	96	Compact jerrycan, electroconductive	198
Beakers, Graduated	228	Compact jerrycan & StopCock set	42
BeefSteaker	160	Compact lever pump	29
Big containers	206	Compact spigot	41
Bio sample scoop	133	Connectors	247
Bio sample spatula	134	Containers, rectangular and round shaped	206
Bio sample spoons	135	Containers, Stacking	203
Blue disposable funnels for liquids	143	Control seal close-it	79
Blue disposable powder funnels	143	Control seal close-it food & pharma	80
Bottle carrier	187	Core Sampler	64
Bottle carrier box	187	CupSampler, Liquid	99
Bottle pumps	14	Cylinders, Graduated	230
Bottles, aluminium	167, 188, 189	D	
Bottles, Dropping	186	Desiccator	272
Bottles, Narrow-necked	170	Detectable forceps, sterile	151
Bottles, Round	171	Detectable funnels for liquids	149
Bottles, Spray	182	Detectable powder funnels	149
Bottles, UN-approved	175, 189	Detectable scoop, long handle, blue	146
Detectable scoops, blue 145			
Detectable scraper, blue 150			
Detectable spatula, blue 146			
Detectable spoon, blue 147			
Detectable spoon curved, long handle, blue 147			
Detectable spoon, long handle, blue 147			
Detectable volumetric spoon, blue 148			
Diaphragm pumps 38			
Dipping bottle 108			
Dipping bottle Ex 109			
Dipping bottles 108			
Dipping vessel 110			
Dip Sampler, plunging siphon 92			
DispoDipper 144, 194			
DispoLadle 115			
DispoLance 117			
DispoPicker 117			
DispoPipette 114			
Disposable funnel for liquids 132, 225			
Disposable funnel for liquids Bio 137			
Disposable pipettes LDPE 236			
Disposable plunging siphon 93			
Disposable powder funnel 132			
Disposable powder funnel Bio 137			
Disposable sampler, blue 138			
Disposable samplers 93			
Disposal kegs, wide-mouth containers 204			
DispoTube 115			
Dosing pumps Dosi-Pump 14			
Dosing spoon and measuring spoon set 154			
Dosing spoon, white 130			
Dosi-Pump 14			
Draining rack, benchtop 241			
Draining rack, wallmount 240			
Drain safety stand 50			
Drill bits for mole 163			
Drop-Boy 187			
Dropping bottles 186			
Drum pump for acids and alkalis 36			
Drum pump for concentrated acids/alkalis 36			
Drum pump for mineral oils 37			
Drum pump for solvents 37			
Dry ice machine 164, 242			
E			
EasySampler 63			
EasyScoop 156			
Electrically conductive canister with			
UN approval 199			
Electric barrel pump Petro 35			
Electroconductive, spigot 43			
EnergyOne 33			
Eye protection / safety goggles 55			
Eye rinsing bottle 53, 273			
Eyewash station 53, 273			
F			
Fittings 266			
Flat seals 50, 267			
Flow indicators CheMobil PMP 253			
Flow indicators LiquiMobil SAN 253			
Flow meters 38			
FoodScoop 157			
Food scoop, blue 138			
Food scoop, long handle, blue 139			
Food spoons, long handle, blue 140			
Foot pumps 10			
Forceps, disposable 130			
Forceps, stainless steel 151			
Four-sided bucket 223			
Four-way-connectors 248			
Funnels 224			
Funnel, stainless steel 225			
Funnel stands 226			
G			
Gas-tight barrel pump PP 28			
General pump accessories 50			
GeoSampler 162			
Gloves, Protective 51, 274			
Goggles, Safety 54			
Graduated beakers, stackable 229			
Graduated beakers with handle 228			
Graduated cylinders, tall form 230			
Graduated pipettes 237			
Gripping tongs 274			
H			
Heat protection 274			
Hose clamp Squeeze-Fix 256			
Hose clips POM 256			
Hose couplings 250			
Hose cutter 245			
Hose pump, Battery-powered 101			
Hose tubing stop-cock 258			
HotGrip 274			

I

IBC discharge valves	49
Ice borer	161
Ice machine, Dry	164, 242
Immersion cylinder	109
Indicators, Flow	252
Industrial bucket with metal handle	222
Instrument servers	220
Instrument trays	219

J

Jerrycans	200
Jerrycans, Safety	208
Jerrycans, Storage	200
Jerrycans, Wide-necked	201
Jumbo sampler	62, 64

L

LaboPlast® Bio scoop	133
LaboPlast® Bio spatula	134
LaboPlast® Bio spoon	135
LaboPlast® scoop, disposable	124
LaboPlast® spatula, disposable	127
LaboPlast® spoon, disposable	128
Laboratory beakers/Griffin beakers, PP	229
Laboratory bottle PET sterile	175
Laboratory bucket	222
Laboratory pump mains operated	34
Laboratory trays / spill troughs set	215
Ladle, long handle, detectable	148
Ladle, long handle, disposable	126
Ladle, long handle, disposable Bio	136
Ladle, long handle, disposable, blue	141
Leakproof wash bottle	185
Lever pump	30
Lever pump aluminium	29
Lever pump with galvanised steel piston rod	30
Lever pump with stainless steel piston rod	30
Liquid CupSampler	99
LiquiDispo	114
Liquid-Sampler	98
LiquiMobil	252
LiquiSampler	91
Location for taking samples	58
Lowering cables	112

M

Magic Box	251
Magnetic centrifugal pumps	39
Magnetic stirring bars	277
Manually-operated reels	112
Measuring jugs industrial	232
Measuring scoops	155
Measuring spoons, blue	141
Meat sampler	160
Meat sampler for carcass sampling	160
Mercury collector	272
MicroDispo	118
MicroSampler	72
Micro-spatula, disposable	152
Micro spatula stainless steel	152
Milky	75
Mini immersion cylinder	110
MiniSampler	102
MiniSampler PE	103
MiniSampler PTFE	103
Mini solvent pump	24
Mini solvent pump reliable filling of small quantities	24
MiniTherm	164
Mini ViscoSampler	89
Mole with handle and bar	163
Multi-Bottles with graduation	179
MultiDispo	118
Multi sampler	61

N

Narrow-necked bio-bottles PE	173
Narrow-necked square bottle	174
Narrow-neck reagent bottle	176
Nipple	268
Non-return valves PP	259
Non-return valves with conical inlet/outlet	259
Novartos	70, 71
Novartos Multi double sampling	71
Novartos Multi triple sampling	71
Novartos Uno double sampling	71
Novartos Uno triple sampling	71

O

Oil-free double-diaphragm pump	38
Oil pump	29

OTAL® battery-pump	9, 11
OTAL® foot pumps	10, 11
OTAL® hand pumps	8, 9
OTAL® liquid transfer pumps	6
OTAL® mini pump made of PP	9

P

Packaging bags with closure	210
Packaging bottle	170
Packaging bucket	210, 221
Peleus ball	238
Petrochemicals, Pumps for	29
PE tubing	244
PharmaPicker	73
PharmaScoop	156
PharmaSpoon	74
Photographic trays	216, 217
Pigment lance	86
Pipette assistants	238
Pipette basket	238
Pipette rinsing system	238
Pipettes	237
Pipette stand	239
Pipetting-ball, Safety	238
Piston pump PP	29
Plastic bag	120, 210, 211
Plastic scoops	158, 159
Plunging siphon, Disposable	93
Pointed/angled shape	130, 142
PowderDispo	116
Powder funnels PP/PE	224
PowderProof®	66, 67
PP barrel pumps	16, 17
Pressure sprayer	184
ProfiSampler	104, 105
ProfiSampler Aluminium	105
Profi Sampler PP	105
Protective gear	51, 274
Protective gloves	51, 274
Protective gloves nitrile	51
PTFE barrel pumps Ultrapur	15
PTFE Scoop	93
PTFE tape	50
PTFE tubing	244
Pump accessories	26
Pump capacity	4
Pump-it® container pump	12

PumpMaster container pumps	13
Pump, Piston	29
Pump safety stand	50
Pumps for petrochemicals	29
Pumps, Vacuum	270
Pürckhauer	162
PVC bung	275
PVC industrial tubing	243
PVC pressure tubing	243

Q

QualiRod conical	87
QualiRod cylindrical	87
QualiSampler set	90
QuickPicker	77

R

Rack, Draining	240
Racks, Test-tube	241
Rapid couplings	260
Reagent bottle	176
Reducing hose connectors	250
Reels, Manually-operated	112
Round bottles with snap closure	171
Rubber bung	275
Rubiflex protective gloves	51, 274

S

safe-it	84
SafetyBox	52
Safety cans stainless steel	208
Safety funnel stainless steel	227
Safety is the top priority	4
Safety jerrycans stainless steel	208
Safety pipetting-ball	238
Safety stand	50
Safety storage container stainless steel	209
Safety wash bottle	185
Sample beaker with cover	166, 195
Sample boxes, aseptic	165, 193
Sampler, All-layer-	61
Sampler for ground water	111
Sampler for silos	68
Sampler, Ice	160
Sampler, LiquidCup	99
Sampler Liquid CupSampler	99
Sampler, Multi	61
Samplers for acids	99

Samplers for silos	68	Soil sampler GeoSampler	162	nector	202
Samplers for tanks	102, 107	Soil sampler Puerckhauer	162	Storage jerrycans	200
Sampler, soil	162	Solvent pump foot operated	20	Straight suction tubes for ProfiSampler	105
Sampler Tubus	75	Solvent pump hand operated	21	Syringe, SteriPlast	123
SampleSafe seal	85	Spatula	89	T	
Sample spatula white, disposable	127	Spatula for foodstuffs, blue	139	Tall-form bottles	171
Sample-spoon	155	Spectacles, Safety	54	Tamper proof labels safe-it	84
Sample spoon white, disposable	128	Spigot „Air“	45	Tape, Sealing	50
Sampling bag SteriBag	120	Spigot „Brass“	46	TargetDispo	119
Sampling bag SteriBag Blue	121	Spigot Jumbo, with tap	48	Target immersion cylinder	111
Sampling bag SteriBag Cleanroom	122	Spill throughs	214	T-connectors	247
Sampling bag, sterilised	120, 211	Spiralus	63	TeleScoop	95, 96, 97
Sampling lance Milky	75	Splinter-proof titrating burette	235	Temperature control	164
Sampling scoop, long handle, disposable	126	Spoon, AISI 304	155	Test-tube racks	241
Sampling spoon curved, long handle, blue	140	Spoon for foodstuffs, blue	140	Thread adapters LaboPlast® 3/4“	47
Sampling spoon, long handle, disposable	129	Spoon, Pharma	74	Thread adapters PP	27
Sampling spoon, long handle, disposable Bio	135	Spoon spatula, disposable	153	Threaded fittings	266, 267, 268, 269
Scoop AISI 304	157	Spoon spatula stainless steel	153	Thread fittings	260
Scoop for food	157	Spray bottle	182	Three-way valves	257
Scoop PTFE	93	Spray bottle Turn'n'Spray	183	Titration burette automatic	234
Scoops and scrapers for foodstuffs	158	Spray bottle with pump vaporiser	181	Transport bottle aluminium UN	189
Scoops and scrapers for industry	159	Stacking containers	203	Transport case for straight suction tubes	105
Scoops, Chemistry	94	Stainless Steel Barrel Pump	18, 19	Transport containers	203
Scoop, Stainless steel	94	Stainless steel measuring spoons	154	Trays, Instrument	219
Scoops, Tele	95	Stainless steel, Safety jerrycans	208	Trays, Laboratory	214
Scraper for foodstuffs, blue	142	Stainless steel scoop	94	Trays, Photographic	216
Scraper LaboPlast®, disposable	131	Stainless steel scraper	150	Tray stainless steel	220
Scraper SteriPlast®	131	Stainless steel spatula	88	Tubes with screw cap	166, 190
Scraper, white	131	Stainless steel spatula	46	Tubing Clamps	254
Scratcher	65	Stainless steel spigot	46	Tubing clamp stop-it metal	255
Screw cap, Tubes with	166, 190	Standard bungs	275	Tubing clamp stop-it with Easy-Click closure	255
Sealable wide-necked bottles	85, 167, 180	Standardised containers	203	Tubings	243
Sealing tape	50	SteriBag	120, 211	Tubs, round	205
seal-it	83	SteriBag StandUp	121, 211	Tubus	75
Seals, Flat	50, 267	SteriBag StandUp sample bag	121	Two-way valves	257
security seal	83	SteriPlast® Bio sample scoop	133	U	
Sedimentation funnel	227	SteriPlast® Bio sample spatula	134	Ultrapure Barrel pumps	15
Servers, Instrument	220	SteriPlast® Kit – sterile sampling set	123	UN-Bottle	175
Silicone bungs	275	SteriPlast® sample scoop	125	UniSampler „Ex“	106
Silicone tubing	245	SteriPlast® sample spatula	127	UniSampler with hose	106
Silo sampler SiloPicker	69	SteriPlast® sample spoon	128	UniSampler with suction lance	107
Single mark pipettes	237	SteriPlast® syringe	123	Universal graduated beakers	233
Single-use tweezers, blue	142	StickProof	74	Universal storage containers	203
Siphon with stopcock	31	Stirring bars, Magnetic	277	Uno sampler	61
SnowPack® dry ice machine	242	Stirring paddle	277		
		StopCock PA, electroconductive	43		
		Stopcocks	40		
		stop-it tube clamps	254		
		Storage and stacking containers	203		
		Storage bottles, with/without threaded con-			

V

VacuMan vacuum or pressure pump	270
VacuMan vacuum pump	270
Vacuum samplers	102
Valve lance	86
Valves, Ball	44
Valves, Two-way and three way	257
Vampire Sampler	100, 101
ViscoDispo	116
ViscoSampler	90

W

Wash bottle	185, 186
Water-jet pump	271
Wax sampler	87
Wide-mouth containers, HDPE	205
Wide-mouth containers with handle	204
Wide-necked bottle	178
Wide-necked boxes, round	190
Wide-necked boxes, square shaped	191
Wide-necked jerrycans with/without threaded connector	201
Wide-necked square bottle	179
Wide-necked wash bottle	185
Wide-neck reagent bottle	177
Withdrawal system for solvents	22, 23

Y

Y-connectors	247
--------------	-----

Z

ZoneDispo	119
Zone samplers	60, 61, 62
Zone sampler Spiralus	63

Contents | by item no.

Item no.	Page	Item no.	Page	Item no.	Page	Item no.	Page	Item no.	Page	Item no.	Page
0006-	20, 24, 44, 45, 50, 73, 103, 112, 243, 244, 245	2327-	210, 221	5330-	90, 91	5613-	29, 30	8533-	45, 267	8763-	264
0300-	171, 174, 197	2348-	74, 210	5331-	90	5618-	15, 17, 19, 50, 52	8535-	34, 269	8770-	265
0301-	179	2350-	223	5334-	154	5620-	270	8536-	269	8771-	265
0302-	170	2502-	54, 55	5336-	99	5625-	39, 271	8537-	50, 267	8772-	265
0303-	173	2507-	51, 52, 53, 273, 274	5338-	74	5627-	29	8538-	50, 267	8773-	265
0304-	175	2515-	53, 273	5339-	160	5690-	19, 50	8539-	267	8774-	265
0306-	186	2601-	208, 209, 227	5340-	69	5700-	34, 36, 38	8540-	259	8775-	265
0307-	187	3414-	203	5341-	89	5762-	36	8545-	44, 266	8780-	261
0308-	171	3418-	203	5344-	120, 121, 122, 211	5763-	37	8546-	266	8781-	261
0309-	181, 182, 183, 184	3440-	206, 207	5346-	73	5765-	38	8547-	44, 266	8782-	261
0310-	185, 186	3460-	205	5347-	65	5766-	39	8548-	45, 266, 267	8783-	261
0314-	171	3482-	205	5350-	162, 163	5780-	35	8605-	257	8801-	243
0317-	204	3490-	207	5351-	65	5900-	33, 34	8606-	257	8802-	243
0318-	67, 77, 178	3600-	67, 68, 69, 77, 86, 87, 163	5353-	94	6202-	192	8607-	257	8803-	101, 245
0319-	105, 106, 107, 178	4201-	214, 215	5354-	94, 96, 97	6205-	103	8608-	257	8804-	103, 105, 244
0320-	178	4202-	217	5355-	95, 96	6206-	165, 193	8610-	258	8805-	103, 105, 244
0322-	85, 167, 180	4203-	217	5356-	156	6210-	192	8614-	258	8875-	243
0327-	167, 188	4206-	217	5357-	99	6214-	166, 190	8618-	256	8876-	103, 105, 244
0329-	189	4207-	217	5358-	71	6250-	192	8619-	255	8879-	244
0331-	174	4208-	218, 220	5359-	86	6282-	190	8677-	256	8881-	101, 245
0332-	174	4230-	219, 220	5360-	63	7102-	228	8678-	256	9602-	224
0338-	179	4702-	219	5365-	108, 109, 110, 111	7103-	166, 195	8700-	249, 250	9604-	225
0340-	103, 176	5000-	7, 11	5369-	86	7104-	228	8701-	249	9606-	224
0342-	99, 177	5005-	7, 9, 11	5370-	157	7109-	233	8703-	250	9614-	155
0355-	191	5201-	12	5371-	157	7110-	229	8704-	250	9622-	226, 239
0356-	191	5202-	13	5378-	123, 124, 125, 126, 127, 128, 129, 130, 131, 132, 138, 139, 140, 141, 142, 143, 145, 146, 147, 148, 149, 150, 151, 152, 153, 154	7118-	226, 227, 239	8705-	247	9630-	226, 239
0357-	191	5301-	68			7122-	229	8706-	247	9635-	241
0361-	187	5302-	67			7204-	232	8707-	248	9640-	240, 241
0370-	175	5303-	79, 80, 81, 83, 84			7210-	232	8708-	248	9650-	238
0401-	202	5304-	62, 63, 64, 65, 91			7502-	231	8710-	249	9668-	271
0402-	202	5305-	103, 105			7503-	231	8711-	247	9695-	234, 235
0431-	201	5307-	72			7506-	230	8712-	247	9760-	275
0435-	42, 43, 197, 198	5308-	111			7550-	237	8713-	248	9763-	275
0500-	44, 45	5309-	112			7551-	237	8714-	251, 259	9764-	275
0525-	40, 43, 197, 198, 201, 202, 206	5310-	64			7553-	237	8715-	251	9768-	274
0530-	41, 197, 201, 202, 206	5311-	87			7554-	238	8717-	248	9789-	272
0533-	45	5313-	89			7555-	236	8720-	253	9791-	272
0534-	48, 49	5314-	24, 105, 106, 107			7556-	236	8740-	262	9805-	164, 242
0535-	46	5315-	92			8203-	277	8741-	262		
0536-	48	5316-	61			8271-	277	8742-	262		
0600-	12, 27, 44, 47, 197, 201	5317-	61, 62			8300-	158, 159	8743-	262		
1105-	204	5318-	63			8501-	268	8744-	262		
1406-	205	5319-	62			8502-	268	8750-	263		
1427-	200	5320-	155			8505-	268	8751-	263		
1428-	199	5321-	75			8506-	268	8752-	263		
2306-	222, 223	5322-	77			8510-	269	8753-	263		
2307-	223	5323-	161			8515-	268	8754-	263		
2308-	222	5324-	74, 156			8516-	268	8755-	263		
2309-	221	5325-	123			8520-	269	8760-	264		
		5326-	98			8525-	269	8761-	264		
		5327-	101			8530-	269	8762-	264		

Disposable funnels for liquids and powders

NEW
from page 132



New – Disposable funnels for liquids and disposable powder funnels

- ▶ For easy and reliable filling or filtering
- ▶ For use in laboratories and clean rooms or for sampling
- ▶ White, white bio, blue or blue detectable
- ▶ Complies with EU food requirements and FDA regulations
- ▶ Disposable, optionally sterilised

b LaboPlast

b SteriPlast

b LaboPlast
Bio

b SteriPlast
Bio



bürkle

9997-1042

