



Automated Injectors  
Automated Switching Valves  
Manual Injectors  
Manual Switching Valves  
Fittings & Accessories  
Software & Training





## Catalog on CD ROM

Rheodyne's complete full-color 32 page catalog with convenient to use hyperlinks for additional product information and authorized distributors worldwide at [www.rheodyne.com](http://www.rheodyne.com).

## MX Module Operating Manual on CD ROM

This 16 page publication contains illustrated flow paths for each MX Module, specifications, installation instructions, operation, maintenance, definition of technical terms, and troubleshooting flow charts.

## MX Module Solutions Guide on CD ROM

This "How To" guide discusses and illustrates the use of Rheodyne's MX Modules for:

- Sample Injection
- Two-Column Selection
- Alternating Column Regeneration
- High Speed Sample Clean Up and Enrichment
- Column Backflushing
- MS Solvent Diversion
- Multi-Dimensional Proteomic Peptide Separations



DryLab® Software . . . . .	2
HPLC Training . . . . .	4
<b>Rheodyne Automated Valves</b>	
Introduction to “MX” Series . . . . .	5
“MX” Products . . . . .	6
<b>Rheodyne Manual Valves</b>	
Introduction to Manual Valves . . . . .	9
Sample Injectors . . . . .	12
Switching Valves . . . . .	17
<b>Rheodyne Parts &amp; Accessories</b>	
Rheodyne Rotor Seals and Stators . . . . .	20
RheBuild® Kits . . . . .	21
Accessories . . . . .	22
Sample Loops . . . . .	24
ChromTRAC™ . . . . .	26
RheFlex® Fittings . . . . .	28
Index . . . . .	32



## DryLab<sup>®</sup> Software for Method Development

What are the REAL costs in your chromatography lab?

**TIME** spent developing methods?

DryLab develops better methods in a fraction of the time spent previously. DryLab models changes to chromatographic variables in seconds, allowing you to evaluate a much wider range of conditions than would ever be practical in the lab. (See Figure 1)

The expense of **CONSUMABLES**?

DryLab saves wear and tear on instrument components and helps develop methods that reduce solvent consumption. You minimize repetitive, time-consuming laboratory runs by finding the best conditions for your separation with DryLab.

Sample **THROUGHPUT**?

DryLab develops faster methods so you can make maximum use of your equipment. Tweak run conditions with DryLab and compare predicted separations at a glance. (See Figure 2)

Problems with **ROUTINE USE** of a Method?

DryLab alerts users to potential problems before they occur, such as the sensitivity of your method to small changes in operating conditions.

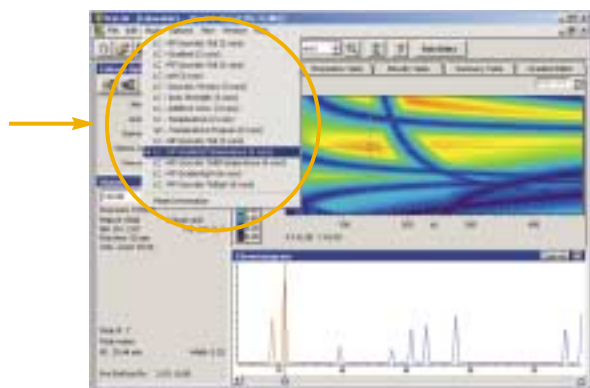

Fig. 1

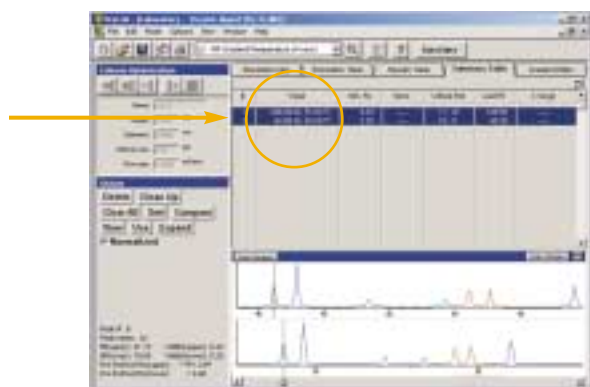

Fig. 2

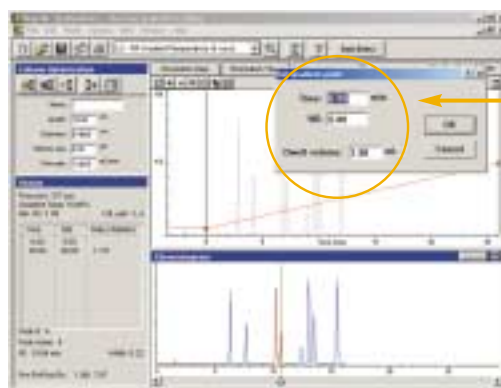

Fig. 3

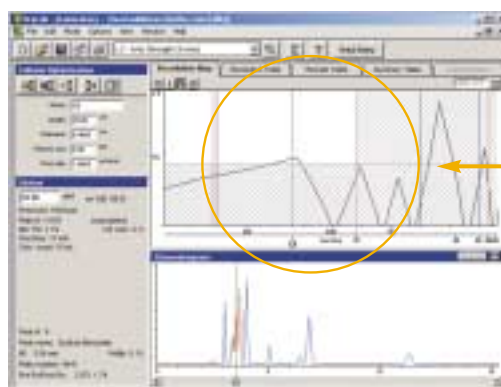

Fig. 4

**Time Spent ADAPTING METHODS?**

DryLab speeds modification of existing methods for new equipment and new columns. For example, gradient methods can be modeled instantly for an instrument with a different dwell volume. (See Figure 3)

**Lack of METHOD RUGGEDNESS?**

DryLab shows you instantly the range of conditions that meet your separation goals. (See Figure 4)

**DryLab Pays for Itself!**

You've heard this claim before, but we **GUARANTEE** it! If DryLab software doesn't pay for itself in the first 30 days (YOU make the decision) we'll refund your money.

DryLab Also Helps You To:

- Improve sensitivity
- Scale up for preparative chromatography
- Enhance the skills of your staff
- Check out the different column configurations without having to buy a new column first
- Compensate for column-to-column variability.

## DryLab<sup>®</sup> 2000 Plus Features

DryLab 2000 Plus is a powerful tool for chromatography development, improvement, troubleshooting, ruggedness testing, and training.

A sample of variables modeled include:

- Isocratic LC percent strong solvent (RP or NP)
- Isocratic LC ternary blending
- Isocratic LC pH
- Isocratic LC buffer concentration
- Isocratic LC additive concentration
- Isocratic LC temperature
- Isocratic LC linear gradient steepness (RP, NP, or IEX)
- Isocratic LC multilinear gradient profile
- Isocratic LC, simultaneous changes in gradient time and temperature
- Isocratic LC, simultaneous changes in gradient time and pH
- Isocratic LC, simultaneous changes in percent strong solvent and temperature
- Isocratic LC, simultaneous changes in strong solvent and pH
- Isocratic LC, pH + ionic strength (RP/IEX)
- Isocratic LC, pH + ionic strength (GFC)
- CE, pH + ionic strength
- Gradient conditions + TFA concentration (gradient RP of peptides)
- Sample load (preparative scale-up)
- Ion chromatography (carbonate/bicarbonate ratio)
- Gradient time/organic solvent ratios
- Ion pair chromatography, IP reagent/pH
- Custom modeling for any combination of two variables
- LC column dimensions, particle size, mobile phase flow rate
- Temperature-programmed GC heating
- Temperature-programmed GC multiramp profile
- Isothermal GC temperature
- Tailing factors (asymmetry factors)

Extras included with DryLab 2000 Plus extend the utility of the core program:

- The Method Development Wizard (MDW) steps through a systematic method development strategy.
- Bi-linear gradient spreadsheet identifies the optimum two-segment gradient conditions.
- k'-plotter displays relationships between retention and mobile phase composition.

DryLab 2000 Plus takes full advantage of the Windows<sup>®</sup> user interface to provide easy, intuitive access to the power of chromatography modeling:

- Retention time and area data for calibration runs can be imported from most chromatography systems
- Extra calibration runs can be included to refine predictions
- Import templates can be customized to match data systems that generate ASCII reports
- Corresponding peaks in calibration runs are matched automatically
- Plate number/peak widths and tailing factors can be specified for each peak
- Resolution Map plots critical resolution vs. the chromatographic variable to quickly evaluate feasibility and identify optimum conditions
- Input conditions and confidence limits are displayed on the Resolution Map
- Interactive method development shows peak movement dynamically as conditions are changed
- Resolution Map Control allows maps to be generated for any subset of peaks in the chromatogram
- Robust Resolution Map displays critical resolution and the resolution/run time relationship
- Chromatograms show the separation for any value of %B, pH, gradient time, temperature, etc.
- Simulations can be printed at high resolution
- Simulated chromatograms can be exported as AIA/Andi files for use with popular data systems
- On-screen editing of gradient or temperature profiles
- Automatic optimization of linear gradients or temperature programs
- Column and solvent optimization are directly coupled; plate count changes dramatically to reflect changes in mobile phase composition
- Column and instrument conditions can be saved for reuse as "standard" conditions
- Saved files can be viewed on any computer
- "Automatic tool kit" provides easy interfacing controls with programs such as Visual Basic, MS, Excel, etc.
- Unlimited telephone and technical support
- Easy to use documentation and on-line Help covering both software operations and chromatographic principles
- On-site training available
- Networked or site license installations available

Call 800-379-5221 today for more information or download an evaluation version of DryLab from [www.lcresources.com](http://www.lcresources.com)

## LC Resources HPLC Training

Along with the prolific author and acclaimed instructor Lloyd Snyder, chromatography authorities John Dolan, Tom Jupille, Derek Southern, Tim Wehr, and Joy Miksic develop and teach core courses on HPLC basics, HPLC method development, and troubleshooting HPLC systems. We also teach specialized courses on subjects such as LC-MS, biopharmaceuticals, and biopharmaceutical validation.

### More Than Theoretical Lectures

You learn best by doing, and to our instructors, “doing” means solving real-life problems and using computer modeling to carry out realistic HPLC experiments right in the classroom. Chromatography modeling helps develop sound instincts in your HPLC work and shows you how to apply what you’ve learned immediately in your own lab.

### Open-Enrollment Courses

**The Practice of Modern HPLC** - This 3-day course covers chromatography theory in practical terms from the ground up.

**Advanced HPLC Method Development** - This 2-day course teaches a powerful and advanced approach to systematic method development.

**Practical HPLC Troubleshooting** - This 2-day course teaches the ins and outs of solving problems that occur with your LC methods.

**Bioanalytical LC-MS** - This 2-day course covers MS detection, MS design and operation, and LC-MS interfacing to obtain qualitative and quantitative data.

**Practical Separations of Biopharmaceuticals** - This 2-day course covers the practical aspects of using high-performance separation techniques for biomolecules, with an emphasis on proteins and peptides.

**Best Bioanalytical Practices for Method Development and Validation** - This 2-day course introduces the best strategies to streamline method development and validation, to provide greater confidence in the analysis, and to ensure that all regulatory concerns are addressed.

### Specialized Courses

All standard open-enrollment courses are available in-house. A number of more specialized courses are offered only on an in-house basis:

- Practical HPLC for Biopharmaceuticals
- Troubleshooting HPLC Systems
- Making HPLC Methods Work
- Introduction to Capillary Electrophoresis
- Improving Quantitative and Qualitative Analysis by HPLC

### In-House Training

If you have more than a half-dozen or so people who could benefit from training, an “in-house” course is an excellent way to maximize the value of a course for your specific requirements. We can present any of our featured courses, or we can create special courses.

“There’s no substitute for in-depth knowledge, years of HPLC research, and thousands of hours of teaching experience.”

### Benefits of In-House Training:

- Convenience

Courses are held at your facility during hours that fit your staffs schedule. We can adjust the course duration and timing to accommodate your lab’s workload.

- Customizable

We can adapt the content of any standard open-enrollment course to focus on the techniques that you use most often and on specific problems encountered in your lab. We send course material ahead of time to incorporate suggested content and our instructors can respond in detail to specific questions.

- Cost-Effective

No travel expenses for multiple staff members. Depending on travel distance, we can provide on-site training to your entire department for less than the cost of sending a half-dozen people to an open enrollment course.

- Consistent

All of your staff members will be taught the same techniques and logical approaches to troubleshooting and method development for consistent solutions to HPLC problems.

- Confidential

Our in-house courses allow open discussion of specific issues relating to confidential projects. Confidentiality agreements? Yes! No information will leave your site.

In-house courses are presented at your workplace and can be customized to department needs — an excellent way to maximize value.

### Year-Round Schedules

Open-enrollment courses are scheduled year-round in major U.S. cities. To find which courses will be presented in a city near you, check [www.lcresources.com](http://www.lcresources.com) or call (800) 379-5221.

### Additional Information

For complete course descriptions, schedules, and registration information, request our 2003 HPLC Course Catalog or download an Acrobat® PDF catalog from [www.lcresources.com/training/trsched.html](http://www.lcresources.com/training/trsched.html).



# Introduction to “MX” Modules

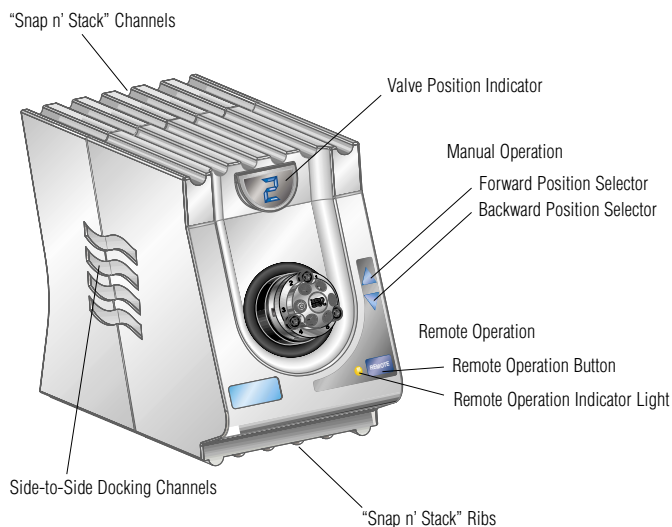

## “MX” Series Automation Modules

A Complete Family of Productivity Enhancing Solutions for Laboratory Automation

- Increase Laboratory Productivity
- Expand Laboratory Capabilities
- Increase Reproducibility
- Improve Analytical Results
- Increase Equipment Reliability
- Save Time and Money
- Make Life Easier

Today’s HPLC fluid injection and switching applications require speed, precision, and flexibility. Rheodyne’s “MX” Series of productivity enhancing solutions for laboratory automation answer these needs. These completely self-contained, electrically actuated valves are available in a variety of flow paths for nano-, micro-, and analytical-scale applications.

### “Manual” or Automatic Actuation

“MX” Modules can be operated by push button, allowing them to function as a “manual” valves, or by contact closure for automated remote control. For multiple automated valve applications, a unique “Snap n’ Stack” System allows units to be stacked vertically or connected horizontally to conserve bench space and reduce connection volumes.

“MX” Modules.	
MODULE SCALE	AVAILABLE FLOW PATHS
Nano-Scale	10 nL Sample Injector
	Two-Position, Six-Port Switching Valve
	Two-Position, Ten-Port Switching Valve
Analytical-Scale	Semi-Automatic Sample Injector
	Two-Position, Six-Port Switching Valves
	Two-Position, Ten-Port Switching Valves

These small, innovative packages and their simple installation make “MX” Modules the solutions of choice for all high-pressure fluid switching and sample injection applications. Many micro-scale applications may utilize the nano-scale modules.

### Nano-Scale Modules

With a mere 10 nL internal sample loop and, more importantly, outstanding dispersion characteristics, Rheodyne’s “MX” Nano-Injector is the ultimate solution for nano- as well as micro-scale applications.

All three Nano-Scale “MX” Modules take advantage of Rheodyne’s proprietary biocompatible DuraLife™ III technology for greatly extended duty cycles. “MX” nano-dispersion Six- and Ten-Port Switching Modules are ideal for on-line sample preparation and LC/MS column switching with minimal band broadening.

### Analytical-Scale Modules

The “MX” Semi-Automatic Injector combines the ease of use of Rheodyne’s industry standard 7725i with the precision actuation of a electrically actuated valve. With its specially designed needle port, sample is loaded directly into the valve. The push of a button injects your sample. By connecting the injector to a single contact closure, a sample can be loaded during system equilibration and injected automatically when the system is ready.

### Outstanding Performance

“MX” Modules are also available in Analytical-Scale Six-Port and Ten-Port Switching Valves with low dispersion. All “MX” Modules incorporate Rheodyne’s time tested miniature “Mighty Valve” — the choice of instrument manufacturers worldwide.

### Versatile

“MX” Modules are designed to increase productivity, expand laboratory capabilities, save time, and make life easier.

### Typical Solutions

- Sample Injection
- Two-Column Selection
- Alternating Column Regeneration
- High Speed Sample Enrichment
- High Speed Sample Clean Up
- Column Backflushing
- MS Solvent Diversion
- Multi-Dimensional Peptide Separation

*These applications are discussed and illustrated in Rheodyne’s “MX” Solutions Guide at <http://www.rheodyne.com/PDFs/2321168A>.*

*Rheodyne’s “MX” Operating Manual including installation instructions is available at <http://www.rheodyne.com/PDFs/2321148A>.*

“MX” Module Specifications.	
Maximum Pressure	345 bar (5000 psi)
Flow Passages	Nano 0.1 mm (0.004") diameter Analytical 0.3 mm (0.012") diameter
Power Requirements	100-120 VAC, 50-60 Hz
Regulatory Compliance	CE Mark
Remote Control	One line contact closure (open = 1, closed = 2)
Operating Temperature	4° - 75° C
Storage Temperature	-40° - 75° C
Dimensions ( H x W x D)	102 mm x 76 mm x 1270 mm (4.5" x 3.0" x 5.0")

# “MX” Modules

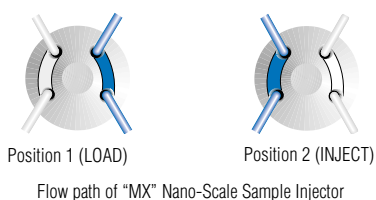

## Nano-Scale Sample Injector

### “MX” Nano Injector

Rheodyne has created the world’s smallest injection valve in a ready-to-use module. The “MX” Nano Injector has a 10 nL internal sample chamber and outstanding low dispersion characteristics. With its 0.1 mm (0.004”) flow passages, the “MX” Nano Injector can be used for micro-scale applications. Maximum pressure is 345 bar (5,000 psi).

### Materials Technology

The “MX” Nano Injector takes advantage of Rheodyne’s proprietary biocompatible DuraLife™ III technology for greatly extended duty cycles in a typical laboratory automation application.

### Actuation

The “MX” Nano Injector can be used in “manual” or automatic mode. A front panel “REMOTE” button allows the injector to be actuated by contact closure from a controlling instrument. A bright LCD light indicates when the injector is in the automatic mode. Simply pressing the button switches the module to “manual” operation. Simply load your sample (Position 1) and press the module’s forward position selector button and the module injects your sample (Position 2).

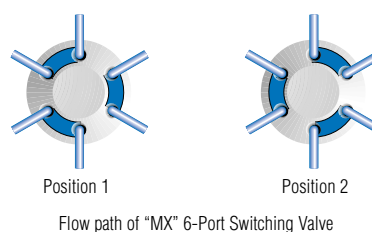

## Nano-Scale Two-Position, Six-Port Switching Module

### “MX” Nano Six-Port Switching Module

Rheodyne’s “MX” Nano Six-Port Switching Module is designed to automate a variety of applications. Like the Nano Injector, this module can be operated by manual push button or, in remote mode, automatically by contact closure with a controlling instrument.

### Passages and Pressure

Flow passages are 0.1 mm (0.004”) in diameter and the module is rated to 345 bar (5,000 psi).

### Extended Lifetime

Rheodyne’s “MX” Nano Six-Port Switching Module contains DuraLife™ III wetted surfaces for high duty cycle lifetime. Following are typical applications:

- Two-Column Selection
- Column Backflushing
- High Speed Sample Clean Up and Enrichment
- MS Solvent Diversion

Nano-Scale Sample Injector Part Number & Description	
PART NUMBER	DESCRIPTION
MX7984-000	“MX” Nano Injector, 10 nL Internal Loop Biocompatible DuraLife™ III

Nano-Scale Six-Port Switching Valve Part Number & Description	
PART NUMBER	DESCRIPTION
MX7980-000	“MX” Nano-Scale, Two-Position, Six-Port Biocompatible DuraLife™ III



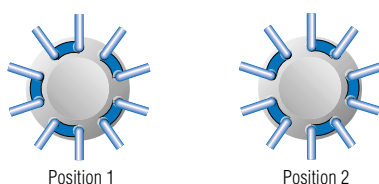

Flow path of “MX” Nano-Scale Ten-Port Switching Valve

## Nano-Scale Two-Position, Ten-Port Switching Module

Rheodyne’s “MX” Nano-Scale Ten-Port Switching Module provides a greater range of automated fluid switching solutions than the six-port module.

### Passages and Pressure

This module contains the same 0.1 mm (0.004”) flow passages, is rated at 5,000 psi, and is available in stainless steel or biocompatible wetted surfaces.

### Applications

Typical applications are:

- Alternating Column Regeneration
- High Speed Sample Enrichment
- Multi-Dimensional Proteomic Peptide Separation

Nano-Scale Ten-Port Switching Valve Part Number & Description	
PART NUMBER	DESCRIPTION
MX7986-000	“MX” Nano-Scale Two-Position, Ten-Port Biocompatible DuraLife™ III



(Syringe not included)

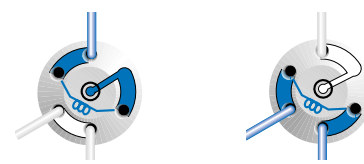

Flow path of “MX” Analytical-Scale Syringe Loading Sample Injectors

## Analytical-Scale Semi-Automatic Sample Injectors

### “Semi-Automatic” Sample Injector

From the 7105 to the 7725i, Rheodyne has been the world’s leader in HPLC sample injection for 25 years. The “MX” Semi-Automatic Injector is the next step in that legacy. By combining the ease of use of a 7725i with the precision actuation of a motorized valve, the “MX” Semi-Automatic Injector is the ideal solution for laboratory sample injection.

### “Manual” or Automatic Injection

A specially designed needle port allows sample to be loaded directly into the valve. The push of a button injects your sample at 120 ms. The “MX” Semi-Automatic Injector is capable of complete automation.

For more information see the “MX” Product Bulletin 231 at <http://www.rheodyne.com/PDFs/2321087A.pdf>

For additional illustrated solutions see Rheodyne’s “MX” Solutions Guide at <http://www.rheodyne.com/PDFs/2321168A.pdf>

For “MX” Operating manual go to - <http://www.rheodyne.com/PDFs/2321148A.pdf>

Analytical-Scale Syringe Loading Sample Injector Part Numbers & Descriptions	
PART NUMBER	DESCRIPTION
MX7925-000	“MX” Analytical-Scale Syringe Loading Sample Injector, Stainless Steel
MX9925-000	“MX” Analytical-Scale Syringe Loading Sample Injector, Biocompatible

# "MX" Modules

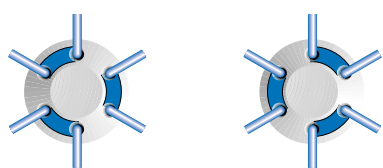

Position 1      Position 2  
Flow path of "MX" Analytical-Scale Six-Port Switching Valves

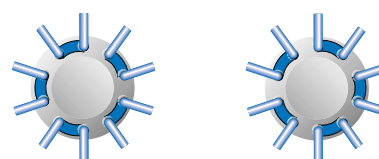

Position 1      Position 2  
Flow path of "MX" Analytical-Scale Ten-Port Switching Valves

## Analytical-Scale Two-Position, Six-Port Switching Modules

### "MX" Analytical Six-Port Switching Module

Rheodyne's "MX" Analytical Six-Port Switching Module is designed to automate a variety of applications. Like the Nano Injector, this module can be operated by manual push button or, in remote mode, automatically by contact closure by a controlling instrument.

#### Passages and Pressure

Flow passages are 0.25 mm (0.010") in diameter and the module is rated to 345 bar (5,000 psi).

#### Extended Lifetime

Following are typical applications:

- Two-Column Selection
- High Speed Sample Clean Up and Enrichment
- Column Backflushing
- MS Solvent Diversion

## Analytical-Scale Two-Position, Ten-Port Switching Modules

Rheodyne's "MX" Analytical Ten-Port Switching Module provides a greater range of automated fluid switching solutions than the six-port module.

#### Passages and Pressure

It contains the same 0.25 mm (0.010") flow passages, is rated at 5,000 psi, and takes advantage of Rheodyne's biocompatible DuraLife™ III wetted surfaces.

#### Applications

Typical applications are:

- Alternating Column Regeneration
- High Speed Sample Enrichment
- Multi-Dimensional Proteomic Peptide Separation

For more information see the "MX" Product Bulletin 231 at <http://www.rheodyne.com/PDFs/2321087A.pdf>

For additional illustrated solutions see Rheodyne's "MX" Solutions Guide at <http://www.rheodyne.com/PDFs/2321168A.pdf>

For "MX" Operating manual go to - <http://www.rheodyne.com/PDFs/2321148A.pdf>

### Analytical-Scale Six-Port Switching Valve Part Numbers & Descriptions

PART NUMBER	DESCRIPTION
MX7900-000	"MX" Two-Position, Six Port, Stainless Steel
MX9900-000	"MX" Two-Position, Six Port, Biocompatible

### Analytical-Scale Ten-Port Switching Valve Part Numbers & Descriptions

PART NUMBER	DESCRIPTION
MX7960-000	"MX" Two-Position, Ten Port, Stainless Steel
MX9960-000	"MX" Two-Position, Ten Port, Biocompatible

## Sample Injectors

### How to Choose a Sample Injector

Table I below compares the characteristics of Rheodyne manual sample injectors and will help you choose the most suitable model. The following discussion details the information in the table.

### Types and Capabilities

Models ending in -25 are dual mode injectors. Dual mode injectors can use both the partial-filling and the complete-filling method for loading the sample loop (Tech Tip #5 on page 23). They are variable volume injectors because they allow the loading of various sample volumes. These dual mode injectors, also called front-loading injectors, have a needle port for loading sample built into the handle. The unique Rheodyne injection port design allows the tip of the needle to connect directly to the sample loop for no sample loss during loading.

Models ending in -10 are single mode injectors. Single mode injectors use only the complete-filling method to load the sample loop. They are called fixed loop injectors as the sample loop size determines the sample volume. These injectors require a Loop Filler Port accessory (page 23), as a needle port is not built into the valve handle. There is not a direct connection between the syringe and the sample loop. Therefore, an excess of sample must be used to overfill the loop filler port and completely fill the sample loop.

Models with an “i” suffix are identical to the models with the same numbers but the “i” designates a built-in position sensing switch. The switch provides the chromatograph with a reproducible start signal to mark the injection time in the data system.

The reproducibility of manual sample injectors depends on operator skill, syringe calibration, and the loading method. Partial-filling method is typically reproducible to 1.0% relative standard deviation (RSD). Complete-filling method is reproducible to 0.1% RSD for loops 5 µL.

### Scale, Sample Volume, and Loop Size

Analytical scale models are for conventional columns with samples from 1.0 µL to 5.0 mL. Micro-scale models are for 1.0 mm and 2.0 mm inner diameter columns. Model 8125 has a sample range of 0.1 µL to 500 µL, and can be used for both analytical and micro columns. Preparative scale models are for columns with diameters from 1 to 10 cm, and operate at high flow rates with samples from 100 µL to 20 mL.

### Liquid Contact Materials

All models have a polymeric rotor seal of Vespel™ (pH 0 to 10 tolerance), Tefzel™, or PEEK (both pH 0 to 14). Stators are 316 stainless steel, titanium, or PEEK. Most models have an inert ceramic stator face assembly.

### Make-Before-Break (MBB®)

Models incorporating Rheodyne’s patented MBB architecture design provide uninterrupted flow when switching between LOAD and INJECT positions. MBB greatly reduces transient pressure shocks and is beneficial for flow-sensitive detectors, fragile columns, and pumps. Models 7725, 9725, 3725, and “i” versions contain the MBB design.

### ChromTRAC™ Mapping

Selected Rheodyne manual valves contain the industry standard ChromTRAC Mapping to color-code your fluid connections. You can identify each port by its colored number, which designate the ChromTRAC color for each system component. Simply coordinate the ChromTRAC colored fittings with the port color.

All valves are ChromTRAC ready. The convenience of ChromTRAC color-coding knobs comes with the RheFlex® Fittings (pages 27-31) you use for all your connections.

TYPE AND CAPABILITIES	SCALE	PARTIAL FILLING VOLUMES (RANGE)	SAMPLE LOOP SIZES (RANGE)	LIQUID-CONTACT MATERIALS	MAX. MPa <sup>1</sup>	MAX. T °C	MBB <sup>2</sup>	MODEL <sup>3</sup>
Dual Mode Can load the loop by two methods: 1) partial filling – syringe determines volume without wasting sample 2) complete filling – loop determines volume by over filling loop	Analytical	1 µL - 2.5 mL	2 µL - 5.0 mL	316 SST, Vespel,	48	80°	Yes	7725, 7725i
		1 µL - 5.0 mL	2 µL - 10 mL	PEEK, Tefzel, ceramic	34	50°	Yes	9725, 9725i
	Preparative	0.1 µL - 500 µL	5 µL - 1.0 mL	316 SST, Vespel, ceramic, PEEK	48	80°	No	8125
		100 µL - 10 mL	2.0 mL - 20 mL	316 SST, PEEK PEEK	34 28	50° 50°	Yes Yes	3725(i)-038 3725, 3725i
Single Mode Can load the loop by one method: Complete filling – loop determines volume by over filling loop	Analytical	Not Applicable	5 µL - 5.0 mL	316 SST, Vespel	48	150°	No	7000
			5 µL - 10 mL	PEEK, Tefzel, ceramic	34	50°	No	9010
	Micro	Not Applicable	0.5 µL - 5 µL	316 SST, Vespel	48	150°	No	7410
			02 µL - 1 µL	316 SST, Vespel	48	80°	No	7520

1. This is the maximum pressure in MPa to which the valve can be adjusted. Some models are shipped from the factory set for lower pressures. 1.0 MPa = 10 bar = 145 psi.

3. Models with an “i” suffix have a built-in position sensing switch. Models 8125 and 9010 each has a built-in switch.

2. MBB® (Make-Before-Break) is a patented Rheodyne design that provides uninterrupted flow when switching between LOAD and INJECT. MBB also greatly reduces transient pressure shocks.

# Introduction to Manual Valves

## High Pressure Switching Valves

Rheodyne offers high pressure manual switching valves to simplify procedures and improve the speed, resolution, and sensitivity of HPLC analysis. The switching valves are available in 316 stainless steel and PEEK, with a choice of 1.6 mm (1/16") or 3.2 mm (1/8") ports.

### Column Selection

The six-position switching valves are used in column selection. These valves substitute one column for another without the need to manually disconnect the plumbing. This makes it easy to designate a separate column to each analysis. Designated columns eliminate equilibration delays, reduce interferences, and prolong column life. Turning the valve handle selects the column desired for a particular analysis. The columns switched off-line are automatically sealed at both ends.

### Column Switching

The two-position switching valves are used to re-route mobile phase during the chromatographic run without changing separation techniques or to perform sequential separations with different columns and/or mobile phases.

Although the Model 7000 is the most commonly used and versatile switching valve, other models have specific uses such as for three-way or four-way switching patterns.

Many models have flow passages available in both standard bore and large bore, designated with an "L" suffix. L Models use 1/16" fittings and tubing but have larger flow passage diameters than non-L models. L models can accommodate higher flow

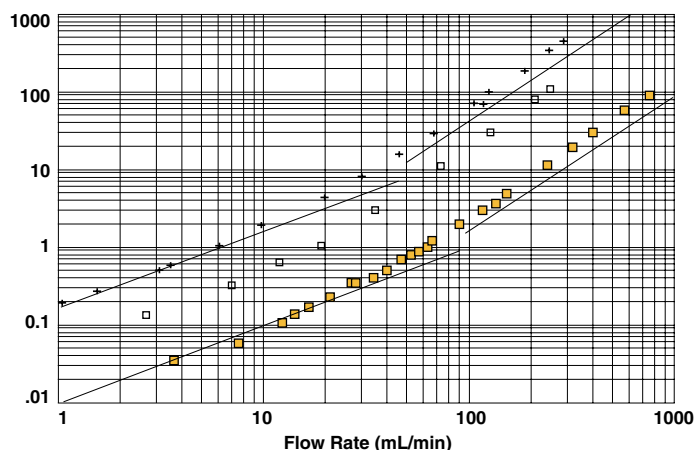

Fig. 1. Pressure drop vs. flow rate for Model 7000 and Model 7000L (large-bore) valves; water at 20°C. Experimental measurements: The flow channel is one stator inlet port, one rotor seal groove, one stator outlet port, and two connecting tubes. Solid squares = (1.0 mm 7000L valve) + (two 1.0 mm x 5.0 cm tubes). Open squares = (0.6 mm 7000 valve) + (two 1.0 mm x 5.0 cm tubes). Cross mark = (0.6 mm 7000 valve) + (two 0.5 mm x 5.0 cm tubes). Solid lines are theoretical values for 10 cm long tubes of 1.0 mm and 0.5 mm ID. Pressure drop is in units of psi. 1.0 MPa = 10 bar = 145 psi.

rates. Large bore tubing can be used when the pressure drop must be limited. Large bore valves have a lower pressure drop than standard bore valves when both valve sizes accommodate the same flow rate.

There are also models manufactured in titanium. Consult your authorized Rheodyne distributor for these options.

Table II. Specifications of Rheodyne Manual Switching Valves.

MODEL	STATOR PASSAGE DIAMETER	FACTORY SET PRESSURE	MAXIMUM FIELD SET PRESSURE	MAXIMUM TEMPERATURE
7000, 7030, 7040 (SST & Titanium)	0.6 mm (0.024")	34 MPa (340 bar, 5000 psi)	48 MPa (483 bar, 7000 psi)	150°C*
7060 (SST)	0.4 mm (0.016")	34 MPa (340 bar, 5000 psi)	48 MPa (483 bar, 7000 psi)	80°C
7000L, 7030L, 7040L, 7060L (SST & Titanium)	1.0 mm (0.040")	21 MPa (207 bar, 3000 psi)	34 MPa (340 bar, 5000 psi)	150°C* (7060L: 80°C)
7610-400 (SST)	0.6 mm (0.024")	34 MPa (340 bar, 5000 psi)	34 MPa (340 bar, 5000 psi)	50°C
7610-600 (PEEK)	0.6 mm (0.024")	34 MPa (340 bar, 5000 psi)	34 MPa (340 bar, 5000 psi)	50°C
9010, 9030, 9060 (PEEK)	0.4 mm (0.016")	34 MPa (340 bar, 5000 psi)	34 MPa (340 bar, 5000 psi)	50°C
3000, 3030, 3060 (PEEK)	1.0 mm (0.040")	21 MPa (207 bar, 3000 psi)	28 MPa (276 bar, 4000 psi)	50°C
3000-038, 3030-038, 3060-038 (SST)	1.0 mm (0.040")	28 MPa (276 bar, 4000 psi)	34 MPa (340 bar, 5000 psi)	50°C

SST = Stainless Steel PK = PEEK \* Titanium valves have a maximum temperature of 50°C, due to the Tetzel rotor seal.

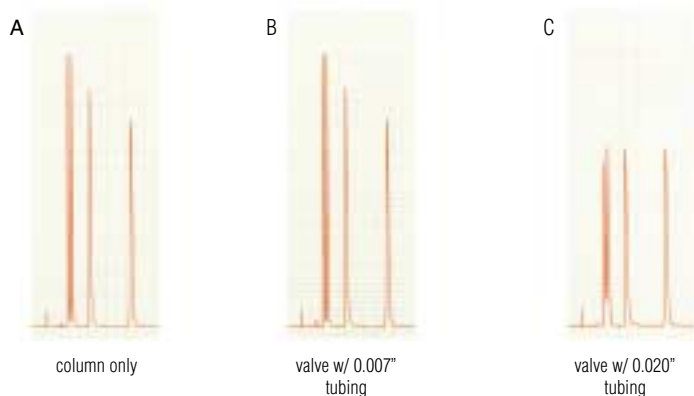

Fig. 2. These chromatograms show the loss of resolution caused by the addition of two Model 7060 column selection valves when using connection tubes of two different inside diameters. Conditions for all cases: 4.6 mm x 12.5 cm column, 5  $\mu$ m C-18 packing, 50% acetonitrile in water, 2.0 mL/min, 21°C, 5.0  $\mu$ L sample partial-filled into a Model 7125 injector, 10 cm x 0.18 mm (0.007") bore injector outlet tube (to column or valve), 10 cm x 0.18 mm bore detector inlet tube (from column or valve), low dispersion 1.0 cm path UV detector cell, 0.2 sec detector time constant. See text for details.

## Effects of Valves and Tubing on Resolution

The effect of tubing on analytical and micro-scale analyses can be significant. Since dispersion caused by tubing is proportional to the fourth power of diameter, large bore tubing should be avoided when performing analytical scale or micro-scale analyses. A size 0.25 mm (0.010") is recommended.

Consider a system with a Rheodyne injector and column switching valves, and analytical columns with small-bore connecting tubing. The chromatograms in Figure 2, made by using a typical analytical chromatograph, show these effects. Scheme A is the control (injector  $\rightarrow$  column  $\rightarrow$  detector) with no valves in the system. In Schemes B and C, two Model 7060 Six-Position Switching Valves were placed side by side (injector  $\rightarrow$  valve #1  $\rightarrow$  column  $\rightarrow$  valve #2  $\rightarrow$  detector).

The injector and detector were connected to these valves by the same tubing used in the control. The extra tubing pieces required to connect the valves to the column were a 10 cm length for valve #1-to-column, and a 35 cm length for column-to-valve #2. The diameters of these tubes are indicated in the Figure caption.

## Tech Tip #1

### How to Avoid Pressure Transients

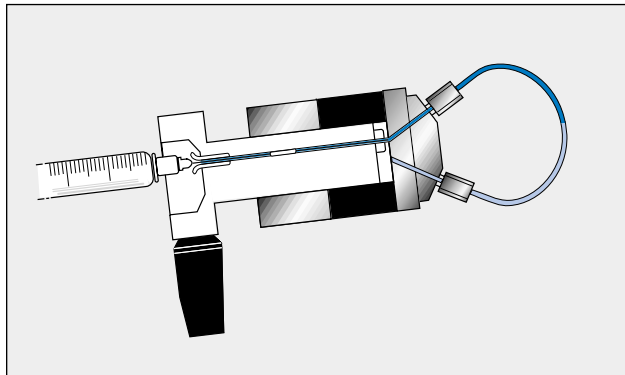

Fig. 1. Air (white) present in the needle port tube is pushed by the syringe during loading into the sample loop.

Air in the sample loop can cause instantaneous system pressure drop that eventually returns to a normal level. Air causes the pressure to drop when the injector moves from the LOAD to the INJECT position. When large sample loops (100  $\mu$ L) are partially loaded, air present in the needle port tube is pushed into the sample loop (see Figure 1). Air can also enter the sample loop from siphoning which occurs when the vent line is higher than the injection port. In either case, upon injection, the system pressure collapses the air bubble, causing pressure to drop momentarily.

A pressure drop in the system caused by air results in changes in retention time, artifact peaks, and affects column performance.

Pressure drops can be avoided by removing the air in the needle port tube. Do this by flushing about 1 mL of mobile phase with a luer syringe with needle port cleaner. Keep the needle port tube filled with mobile phase by occasional flushing. Adjust the vent line(s) so the outlet is at the same horizontal level as the needle port (see Figure 2). For additional injection troubleshooting, refer to the Rheodyne Troubleshooting Guide for HPLC Injection Problems. You may download the Guide from the Rheodyne web site: [www.rheodyne.com](http://www.rheodyne.com) under Tech. Support. You can also request a copy by using the reply card at the back of this publication.

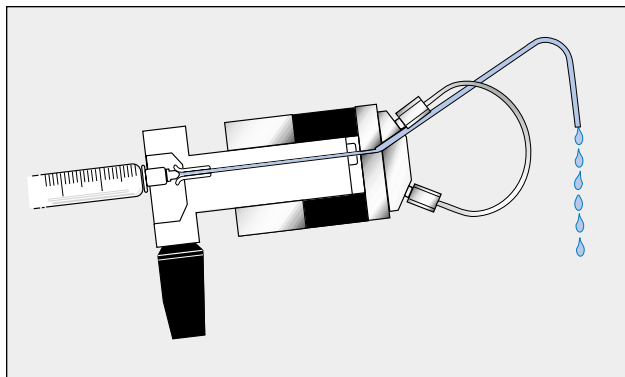

Fig. 2. Pathway of the flushing mobile phase using the Needle Port Cleaner, Part # 7125-054 (see p. 22) when the injector is in INJECT.

# Sample Injectors



## Models 7725, 7725i, 9725, and 9725i Analytical Injectors

The 316 stainless steel models 7725 and 7725i, and PEEK models 9725 and 9725i are Rheodyne's most advanced manual sample injectors for analytical HPLC. Specialized features include:

- The Rheodyne patented Make-Before-Break (MBB®) architecture allows continuous flow between LOAD and INJECT positions which greatly reduces transient pressure shocks that disrupts your system. See Figure 3.
- Wide, 30° port angles offer easier access to fittings using the Rheodyne Wrench (Part # 6810 on page 22).
- Front-end pressure screw makes it easy to adjust and maintain pressure.
- Capability of a reproducible 2 µL sample injection with a 2 µL internal sample loop.
- A built-in position sensing switch ("i" versions) provides the chromatograph with a reproducible start signal.

Figure 3 illustrates the MBB valve design. In the LOAD position, mobile phase flow from pump port to column port travels through both the rotor seal groove and the MBB passage (Position A). As the rotor seal grooves rotate to change from LOAD to INJECT, there is continuous mobile phase flow through both one rotor seal groove and the MBB passage (Position B) until the rotation stops and both rotor seal grooves are connected by the loop. Sample flow begins through the loop to the column just as all flow stops through the MBB passage (Position C). Sample flow never enters the MBB passage.

The injectors contain a patented Rheodyne needle port design that connects the tip of the syringe needle directly to the sample loop ensuring zero

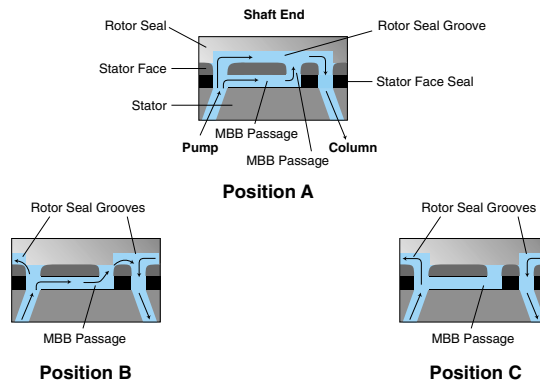

Fig. 3. Flow paths of Model 7725 and 9725 with patented Rheodyne MBB design.

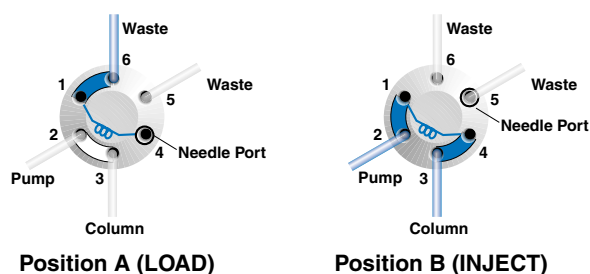

Fig. 4. Flow paths of the LOAD and INJECT positions of models 7725 and 9725 sample injectors.

sample loss, no cross-contamination, and syringe accuracy. These versatile front-loading injectors allow both partial-filling method (reproducibility of 1.0% RSD) and complete-filling method (reproducibility of 0.1% RSD). This dual mode capability varies sample volumes desirable for your analytical analysis. See Tech Tips #5 and 6 on pages 23 and 27.

Flow switching occurs at a flat interface between a polymeric rotor seal and a ceramic stator face assembly in both the stainless steel and PEEK models. You can have confidence in the long seal life of this genuine Rheodyne part combination.

A simple, three-step operation involves inserting the syringe into the needle port while in the LOAD position and turning the handle to INJECT. The sample is on its way through your system and when the handle returns to LOAD, the injector is ready for the next injection.

A 20 µL sample loop is furnished and accessory loops and syringes are listed on page 22. See Table I in Introduction to Rheodyne Manual Valves on page 9 for detailed specifications.

View the online product product bulletin - <http://www.rheodyne.com/2320617A.html>

Sample Injector Part Numbers & Descriptions		
PART NUMBER	DESCRIPTION	STATOR MATERIAL
7725	Dual Mode Analytical Injector	Stainless Steel
7725i	Dual Mode Analytical Injector with Switch	Stainless Steel
9725	Dual Mode Analytical Injector	PEEK
9725i	Dual Mode Analytical Injector with Switch	PEEK

# Sample Injectors

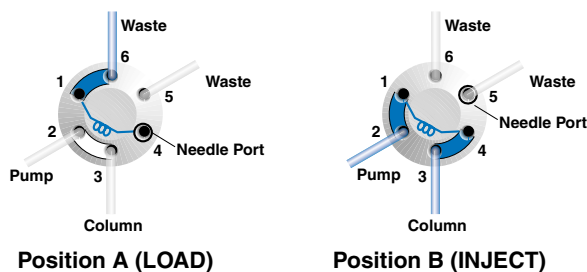

Fig. 6. Flow paths of the LOAD and INJECT positions of Model 8125 sample injector for micro-scale analyses.

## Model 8125 Micro-Scale Injector

Model 8125 is Rheodyne's solution to your micro-scale analyses. Made of 316 stainless steel and designed for 1.0 mm (0.04") and 2.0 mm (0.08") micro-bore columns, the adaptable injector is also compatible with analytical columns (3.0-5.0 mm, 0.12-0.20"). Model 8125's built-in position sensing switch provides the chromatograph with a reproducible start signal.

This versatile injector allows both partial-filling method (reproducibility of 1.0% RSD) and complete-filling method (reproducibility of 0.1% RSD). See Tech Tips #5 and 6 on pages 23 and 27. To save loading time into the 8125's small flow passages, the largest loop recommended for the complete-filling method is 200  $\mu$ L. This dual-mode capability varies sample volume desirable for your micro-scale analysis.

Micro-scale 8125 sample loops use 0.5 mm (0.020") OD tubing instead of the conventional 1.6 mm (1/16") OD tubing to provide low-dispersion performance. The versatile 8125 can also accommodate 1.6 mm (1/16") OD tubing. The presence of a mixing cavity between the loop and injector port is less likely when using the smaller size tubing. Cavities may cause high dispersion and peak distortion (Tech Tip #8 on page 31).

Table III compares the improved resolution using the 8125 to analytical scale injectors, such as the 7725. The improvement is greatest with relatively unretained (low  $k'$ ) peaks. Table IV on page 15 compares the 8125 performance with other Rheodyne micro injectors.

Flow switching occurs at a flat interface between a polymeric rotor seal and a ceramic stator face assembly in both the stainless steel and PEEK models. You can have confidence in the long seal life of this genuine Rheodyne part combination.

A simple, three-step sample injecting operation involves inserting the syringe into the needle port while in the LOAD position and turning the handle to INJECT. The sample is on its way through your system and when the handle returns to LOAD, the injector is ready for the next injection. Figure 6 illustrates the flow paths of the positions.

A 5  $\mu$ L sample loop is furnished and syringes, accessory loops and fittings are listed on pages 23 -30. See Table I in Introduction to Rheodyne Manual Valves on page 9 for detailed specifications.

**Table III. Comparison of Observed Column Plates of Rheodyne Analytical and Micro-Scale Injectors.**

	7125	8125	▲
$k' = 0.6$	2930	5054	72%
$k' = 1.5$	4653	6904	48%
$k' = 7.9$	7875	8305	5.0%

UV detector: 1  $\mu$ L volume, 4 mm path. Sample volume: 2  $\mu$ L, partial-filling method. Column: 2 mm ID x 100 mm long, 4  $\mu$ m C-18. True plates of column = 11,570.

### Sample Injector Part Number & Description

PART NUMBER	DESCRIPTION	STATOR MATERIAL
8125	Dual Mode Micro-Scale Injector	Stainless Steel

# Sample Injectors



## Model 7520 Internal Sample Chamber Micro-Scale Injector

The 316 stainless steel Model 7520 can inject the smallest volume of all Rheodyne sample injectors with the highest reproducibility. This low-dispersion injector uses a small hole drilled in a flat rotor as an internal sample chamber for precise sample injection. The rotor is available in 0.2, 0.5, and 1  $\mu\text{L}$ . The 0.5  $\mu\text{L}$  rotor is factory installed.

The 7520 requires the complete-filling method of loading the internal sample chamber. Excess sample is required to completely flush mobile phase from the chamber. Reproducibility is 0.1% RSD. See Tech Tips #5 and 6 on pages 23 and 27.

Table IV compares the 7520 to the other two Rheodyne micro-scale injectors. Note that the 8125 is a dual mode injector that uses the partial-filling method, while the 7520 and 7410 are single mode injectors that can only use complete-filling method.

Figure 7 shows the sliding rotor. The sample loads into the internal sample chamber by inserting a syringe needle into the built-in needle port. The virtually undetectable space between the needle tip and sample chamber contains only a 0.3  $\mu\text{L}$  cavity, which results in little sample waste.

The outlet stator passage is 0.13 mm (0.005") in diameter. A column connection of matching ID is factory installed. The tubing is 1.6 mm (1/16") OD x 5.0 cm (2.0") long. Flow switching occurs at a flat interface between a polymeric rotor seal and a stainless steel stator. You can have confidence in the long seal life of this genuine Rheodyne part combination.

Accessory syringes are listed on page 23. See Table I in Introduction to Manual Valves on page 9 for detailed specifications.

View the online product product bulletin - <http://www.rheodyne.com/2320612A.html>



## Model 7410 Low-Dispersion Micro-Scale Injector

The 316 stainless steel Model 7410 is a single mode injector (uses complete-filling method) with an interchangeable internal sample loop ideal for micro-scale analyses. The injector has a 1  $\mu\text{L}$  internal sample loop and low-dispersion flow passages for 1.0 mm (0.04") and 2.0 mm (0.08") micro-bore columns. The adaptable injector is also compatible with analytical columns (3.0-5.0 mm, 0.12-0.20").

The 7410 requires the complete-filling method of loading the sample loop. Excess sample is required to completely flush mobile phase from the loop. Reproducibility is 0.1% RSD. See Tech Tips #5 and 6 on pages 23 and 27. Table IV compares Rheodyne micro-scale injectors.

The operator can fill the sample loop by either pressure or suction loading. This simple, three-step operation involves inserting the syringe into the accessory Needle Port (Part # 9013, page 23) or a Loop Filler Port (Part # 7012 or Part # 9012, page 23) while in the LOAD position, and then turn the handle to INJECT to send your sample into the sample loop. Return the handle to LOAD, and the injector is ready for the next injection. Figure 8 illustrates the flow paths of the positions.

Flow switching occurs at a flat interface between a polymeric rotor seal and a stainless steel stator. You can have confidence in the long seal life of these genuine Rheodyne part combinations.

Accessories, including syringes, are listed on page 23. Interchangeable internal sample loops are available in 0.5, 1, 2, and 5  $\mu\text{L}$  volumes.

See Table I in Introduction to Manual Valves on page 9 for detailed specifications.

View the online product product bulletin - <http://www.rheodyne.com/2320611A.html>



## Tech Tip #2

### How to Find and Fix Common Leaks

Leaks cause valuable sample loss. Nobody wants that. The key to the valve holding pressure is the integrity of the sealing surfaces. If there is a scratch on the sealing surface, or the needle seal in the rotor seal is damaged, a leak may appear. It is also important to realize what appears to be a leak can instead be a result of siphoning. The following are the three most common situations in which fluid leaks occur.

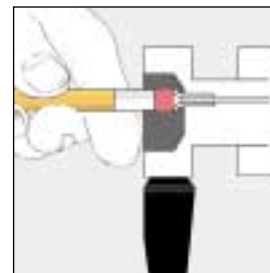

Fig. 1. To reform the needle seal, push the eraser end of a pencil against the needle port.

1. If fluid leaks out of the needle port only while loading the loop (i.e., while pushing down on the plunger of the syringe), the problem is most likely that the needle seal or the needle port fitting in the loop filler port is not gripping the syringe needle tightly enough to prevent leakage around the syringe needle. Tighten the needle seal grip by pushing down on the needle port (See Figure 1) or replace the needle port fitting to make a tighter grip on the needle. The tightening reduces the hole diameter of the needle seal and port fitting.

2. If fluid leaks continuously from the needle port or vent lines and/or from the stator-to-stator ring interface, the rotor seal and/or stator face assembly needs to be replaced. Scratches on the rotor seal or cracks in the stator face assembly allow mobile phase to escape and cause cross port leakage. Genuine Rheodyne replacement rotor seals are listed on page 20.

3. If fluid leaks from the needle port and/or vent lines but eventually stops, the cause is most likely siphoning and not a leak. Siphoning occurs if the vent lines are lower or higher than the needle port. Adjust the vent line(s) so that the outlet is at the same horizontal level as the needle port to prevent siphoning. (See Figure 2).

For other leakage or injection troubleshooting, refer to the Rheodyne Troubleshooting Guide for HPLC Injection Problems. You may download the Guide from the Rheodyne web site: [www.rheodyne.com](http://www.rheodyne.com) under Tech. Support. You can also request a copy by using the reply card at the back of this publication.

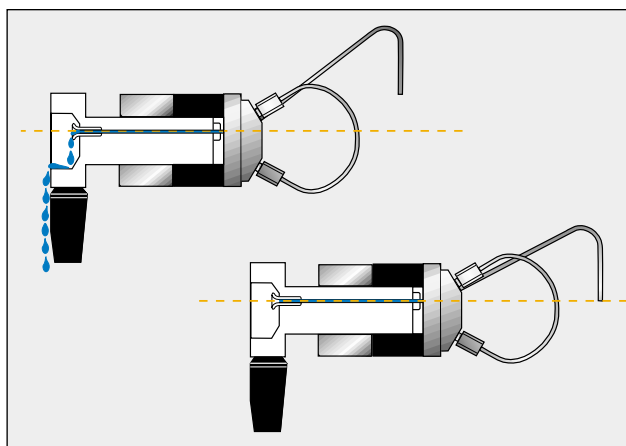

Fig. 2. Needle port level compared to the level of vent line outlet: (A) siphoning occurs when the vent line outlet is above the needle port level; (B) siphoning does not occur if the vent line outlet is the same horizontal level as the needle port.

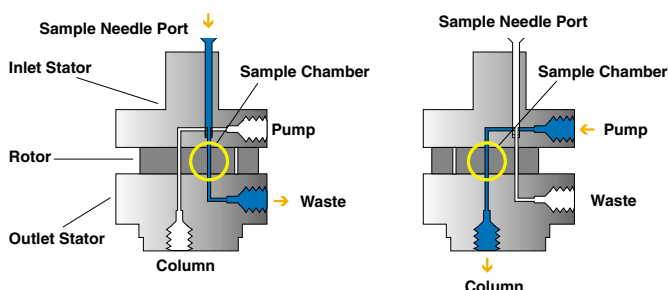

Fig. 7. Flow path of Model 7520 Internal Sample Chamber Micro-Scale Injector.

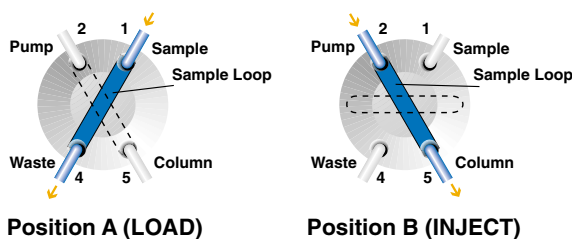

Fig. 8. Flow paths of the LOAD and INJECT positions of Model 7410.

Table IV. Comparison of Low-Dispersion Micro-Scale Injectors.

RHEODYNE MODEL	8125	7410	7520
Complete-Filling ( $\mu\text{L}$ )			
loop volume / load volume	5/15	5/30	---
	---	2/25	---
	---	1/25	1/17
	---	0.5/40	0.5/4.0
	---	---	0.2/3.0
Partial-Filling ( $\mu\text{L}$ )	0.1-500	N/A	N/A
Dispersion ( $\mu\text{L}^2$ )			
5.0 $\mu\text{L}$ sample (200 $\mu\text{L}/\text{min}$ )	5.4	6.3	---
(400 $\mu\text{L}/\text{min}$ )	5.8	7.2	---
1.0 $\mu\text{L}$ sample (50 $\mu\text{L}/\text{min}$ )	0.8	0.6	1.0
(200 $\mu\text{L}/\text{min}$ )	1.0	0.6	2.0
0.2 $\mu\text{L}$ sample (50 $\mu\text{L}/\text{min}$ )	0.8	---	0.3
(200 $\mu\text{L}/\text{min}$ )	0.8	---	0.3

The load volume is the sample volume loaded into the loop which results in an injection of 95% of the maximum possible sample mass. The volumes required for the 7410 are large because a 7012 Loop Filler Port (page 23) was used. Less sample is needed when using the 9013 Needle Port (page 23).

#### Sample Injector Part Numbers & Descriptions

PART NUMBER	DESCRIPTION	VALVE MATERIAL
7520	Single Mode Internal Sample Chamber Micro-Scale Injector	Stainless Steel
7520-011	0.2 $\mu\text{L}$ Rotor	
7520-012	0.5 $\mu\text{L}$ Rotor	
7520-013	1 $\mu\text{L}$ Rotor	
7410	Single Mode Low-Dispersion Micro-Scale Injector	Stainless Steel
7410-070	0.5 $\mu\text{L}$ Loop Disc	
7410-071	1 $\mu\text{L}$ Loop Disc	
7410-072	2 $\mu\text{L}$ Loop Disc	
7410-073	5 $\mu\text{L}$ Loop Disc	

# Sample Injectors



## Models 3725-038, 3725i-038, 3725, and 3725i Preparative Scale Injectors

Models 3725-038 and 3725i-038 (316 stainless steel) and 3725 and 3725i (biocompatible PEEK) are the most suitable manual valves to use with large sample volumes, high flow rates, and preparative columns sized 1.0-10 cm (0.4-4.0") in diameter. The ports accommodate 3.2 mm (1/8") OD tubing, and 1.6 mm (1/16") OD tubing with the Adapter accessory (Part # 6000-076, page 31). The 1.0 mm (0.040") diameter passages allow flow rates of 10 to 100 mL/minute with virtually no pressure drop. These versatile injectors allow both partial-filling method (reproducibility of 1.0% RSD) and complete-filling method (reproducibility of 0.1% RSD). This dual-mode capability allows variable sample volumes desirable for your preparative scale analyses. See Tech Tips #5 and 6 on pages 27 and 29.

The "i" version injectors' built-in position sensing switch provides the chromatograph with a reproducible start signal.

These preparative scale injectors incorporate Rheodyne's patented Make-Before-Break (MBB®) architecture allowing continuous flow between LOAD and INJECT positions which greatly reduces disruptive transient pressure shocks to your system.

Figure 9 illustrates the MBB valve design. In the LOAD position, mobile phase flow from pump port to column port travels through both the rotor seal groove and the MBB passage (Position A). As the rotor seal grooves rotate to change from LOAD to INJECT, there is continuous mobile phase flow through both one rotor seal groove and the MBB passage (Position B) until the rotation stops and both rotor seal grooves are connected by the loop. Sample flow begins through the loop to the column just as all flow stops through the MBB passage (Position C). Sample flow never enters the MBB passage.

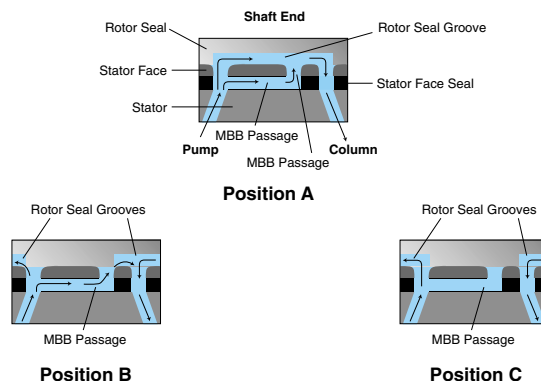

Fig. 9. Flow paths of Model 3725(i) and 3725(i)-038 with patented Rheodyne MBB design.

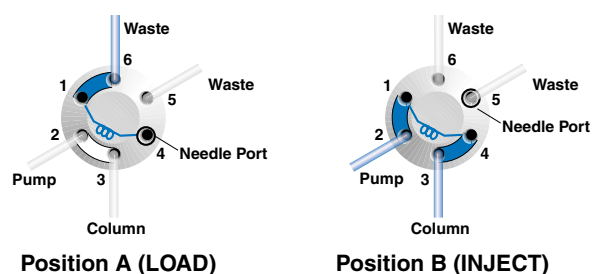

Fig. 10. Flow paths of the LOAD and INJECT positions of models 3725(i) and 3725(i)-038 sample injectors.

A simple, four-step operation involves inserting the syringe into the needle port while in the LOAD position and turning the handle to INJECT. The sample is on its way through your system. To shield from mobile phase ejecting out of the needle port, remove the syringe and place the plug attached to the handle into the needle port while still in INJECT position. Turn the handle back to LOAD, and remove the plug for the next injection. Figure 10 illustrates the flow paths of the positions.

Flow switching occurs at a flat interface between a polymeric rotor seal and a PEEK stator face assembly in both the stainless steel and PEEK models. You can have confidence in the long seal life of this genuine Rheodyne part combination.

*A 10 mL sample loop is furnished and syringes and accessory loops are listed on pages 24 and 25.*

*See Table I in Introduction to Manual Valves on page 9 for detailed specifications.*

*View the online product product bulletin - <http://www.rheodyne.com/2320615A.html>*

Sample Injector Part Numbers & Descriptions		
PART NUMBER	DESCRIPTION	STATOR MATERIAL
3725-038	Dual Mode Preparative Injector	Stainless Steel
3725i-038	Dual Mode Preparative Injector with Switch	Stainless Steel
3725	Dual Mode Preparative Injector	PEEK
3725i	Dual Mode Preparative Injector with Switch	PEEK



## Two-Position Switching Valves Models 7000(L), 3000-038, 3000, 7610-400, 7610-600, and 9010

The versatile two-position, six-port and ten-port valves are available in 1/16" and 1/8" port sizes, and 316 stainless steel and PEEK versions. These valves redirect flow among columns during the chromatographic run. They are also useful for selecting between two columns as shown in Figure 13 on page 19. Compare Model 7000 to the Three-Way Switching Valve (Model 7030) in which each end of the off-line column is independently sealed instead of connected together head-to-tail. Independent seals produce less shock to the column if the valve switches before all the pressure leaves the column. A ten-port valve can often accomplish the same operation that requires two six-port valves.

Model 9010 PEEK sample injector can convert to a six-port switching valve functionally identical to Model 7000 by removing the loop.

Switching Valve Part Numbers & Descriptions		
PART NUMBER	DESCRIPTION	STATOR MATERIAL
7000	Two-Position, Six-Port Switching Valve (1/16")	Stainless Steel
7000L	Two-Position, Six-Port Large Bore Switching Valve (1/16")	Stainless Steel
3000-038	Two-Position, Six-Port Switching Valve (1/8")	Stainless Steel
3000	Two-Position, Six-Port Switching Valve (1/8")	PEEK
7610-400	Two-Position, Ten-Port Switching Valve (1/16")	Stainless Steel
7610-600	Two-Position, Ten-Port Switching Valve (1/16")	PEEK
9010	Single Mode Analytical Injector	PEEK



## Three-Way Switching Valves Models 7030(L), 9030, 3030-038, and 3030

Two-position, six-port valves with a double three-way switching pattern are available in 1/16" and 1/8" port sizes, and 316 stainless steel and PEEK versions.

See Introduction to High Pressure Switching Valves on page 10 for detailed specifications.

View the online product product bulletin - <http://www.rheodyne.com/2320613A.html> (web link shows both valves on this page)

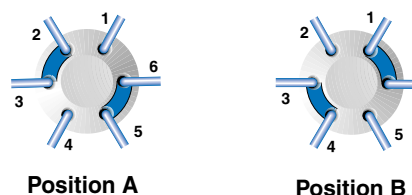

Position A

Position B

Fig. 11. Flow diagram of a Three-Way Switching Valve.

Switching Valve Part Numbers & Descriptions		
PART NUMBER	DESCRIPTION	STATOR MATERIAL
7030	Three-Way Switching Valve (1/16")	Stainless Steel
7030L	Three-Way Large Bore Switching Valve (1/16")	Stainless Steel
9030	Three-Way Switching Valve (1/16")	PEEK
3030-038	Three-Way Switching Valve (1/8")	Stainless Steel
3030	Three-Way Switching Valve (1/8")	PEEK

# Switching Valves



## Four-Way Switching Valves Models 7040 and 7040L

The two-position, six-port 316 stainless steel valves contain an external loop that exchanges the flow pattern from ports (2 to 3 and 4 to 6) to (2 to 6 and 4 to 3). This flow pattern facilitates applications such as column backflushing.

Other Rheodyne valves can convert to a four-way valve. Model 9010 PEEK sample injector (page 17) becomes four-way by changing the loop to connect Ports 1 and 5. Model 3000 PEEK switching valve (page 17) becomes four-way by adding an external loop connecting Ports 1 and 5.

View the online product product bulletin - <http://www.rheodyne.com/2320613A.html>  
(web link shows both valves on this page)

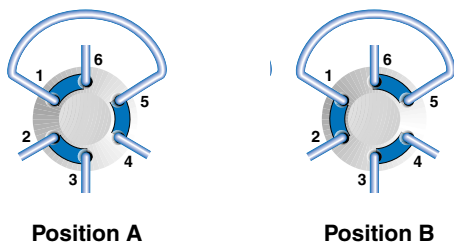

Fig. 12. Flow diagram of a Four-Way Switching Valve.



## Six-Position Switching Valves Models 7060(L), 9060, 3060-038, and 3060

Rheodyne's Six-Position Switching Valves make HPLC analyses easier and better. Two manually operated six-position valves allows convenient selection among six columns for different analytical methods on the same chromatograph. The advantages of using these valves over manually changing columns are immediate selection, no wear on fittings from repeated tightening, and the valve seals both ends of the off-line columns and keeps them on stand-by for future use.

For manual column selection, the center port of one valve connects to an injector. Turning the valve handle directs flow into one of up to six columns connected to the valve's six peripheral ports. A second six-position valve connects to the column outlets to select the operating column effluent and to direct it to the detector.

The sixth port may be used for a bypass/flush-out tube. This connection permits rapid mobile phase changeover without exposing any column to a mobile phase other than the one with which it is routinely used. See Figure 14 on page 19 for suggested applications.

These six-position valves are available in different materials (such as 316 stainless steel and PEEK) as well as both 1/16" and 1/8" port sizes. Models accepting 1.6 mm (1/16") fittings have internal passages of 0.4 mm (0.016") ID with a total internal volume of less than 2  $\mu$ L. Refer to Effect of Valves and Tubing on Resolution on page 11.

Models accepting 3.2 mm (1/8") fittings and the large bore, "L" versions are used to avoid excessive pressure drops when using high flow rates. See Figure 1 on page 10 for pressure drop information. These models also can be used for mobile phase selection by connecting the center port to a pump inlet.

See Introduction to High Pressure Switching Valves on page 10 for detailed specifications.

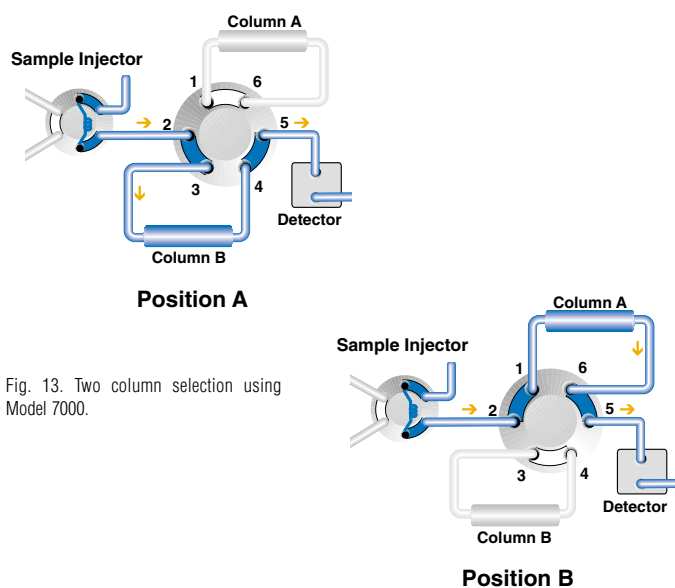

Fig. 13. Two column selection using Model 7000.

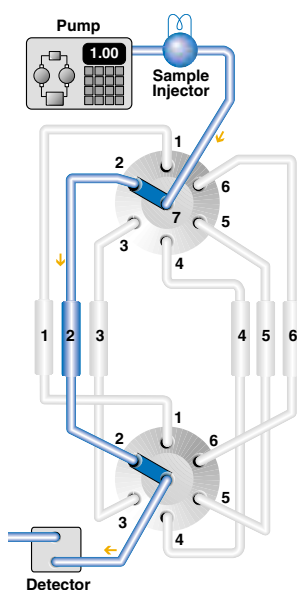

Fig. 14. Six column selection using two Model 7060 switching valves.

Switching Valve Part Numbers & Descriptions		
PART NUMBER	DESCRIPTION	STATOR MATERIAL
7040	Four-Way Switching Valve (1/16")	Stainless Steel
7040L	Four-Way Large Bore Switching Valve (1/16")	Stainless Steel
7060	Six-Position Switching Valve (1/16")	Stainless Steel
7060L	Six-Position Large Bore Switching Valve (1/16")	Stainless Steel
9060	Six-Position Switching Valve (1/16")	PEEK
3060-038	Six-Position Switching Valve (1/8")	Stainless Steel
3060	Six-Position Switching Valve (1/8")	PEEK

## Tech Tip #3

### How to Use Proper Syringe Needles

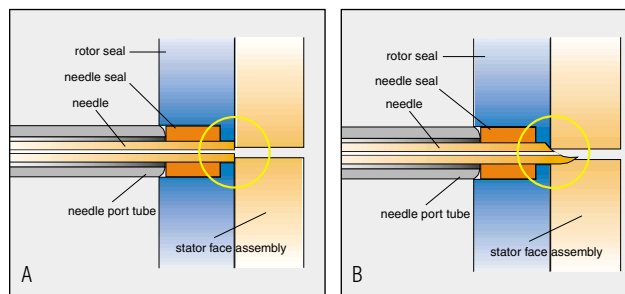

Fig. 1. A square cut needle (A) stops against the stator face assembly. The tip of a pointed needle (B) slips into the stator face and the tip breaks off as the valve rotates.

With front-loading injectors it is important to use the correct needle when loading the sample loop. An incorrect needle will damage the valve and can cause poor reproducibility. When the needle is too short the tip will not reach the needle seal. When the needle is too small in diameter the seal will not grip tightly enough. Needles with a beveled tip can damage the rotor seal and stator face assembly (see Figure 1). The needle should be #22 gauge, and 90 point style (square cut end). Model 3725 requires a #16 gauge needle. Never use a beveled, pointed, or tapered needle.

Needle specifications are not critical when using a Loop Filler Port to load the sample loop. However, it is important to tighten the needle port fitting around the needle if using a syringe needle with a slightly smaller diameter than 0.7 mm (0.028").

If the loading method used is complete-filling, a syringe without a needle can be used. A syringe fitted with a Needle Port Cleaner can be used with a front-loading valve (Figure 2A) or with a Loop Filler Port (Figure 2B). Syringe needles are listed on page 23.

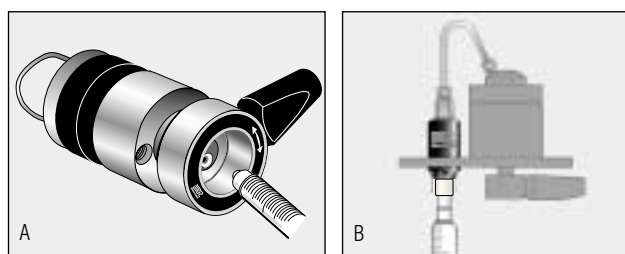

Fig. 2. (A) Syringe fitted with Needle Port Cleaner (Part # 7125-054) loading a front-loading valve (Model 7725); (B) loading a Loop Filler Port (Part # 7012).

# Rheodyne Rotor Seals and Stators



## Rotor Seals and Stators

The rotor seal is the polymeric disc that makes a high pressure seal against the stator. The seal wears with use and is one of the only parts that may need routine replacement. Stators need replacement only if the ports or sealing surfaces become damaged.

Vespel blend rotor seals have an operating pH range from 0 to 10. Tefzel blend and PEEK blend rotor seals have a pH range from 0 to 14. Strong oxidizing acids such as concentrated nitric and sulfuric are not compatible with PEEK.

Stators are available in 316 stainless steel and PEEK. Our materials of construction have been researched and selected for their physical and mechanical strength.

### Vespel™ Blend Rotor Seal Part Numbers & Descriptions

PART NUMBER	DESCRIPTION
7010-039	Vespel Rotor Seal for 7010, 7000, 7040
7030-003	Vespel Rotor Seal for 7030
7060-070	Vespel Rotor Seal for 7060, 7066
7125-047	Vespel Rotor Seal for 7125, 7725
7410-038	Vespel Rotor Seal for 7410
7413-013	Vespel Rotor Seal for 7413
8125-038	Vespel Rotor Seal for 8125

### PEEK Blend Rotor Seal Part Numbers & Descriptions

PART NUMBER	DESCRIPTION
3030-005	PEEK Rotor Seal for 3030, 3030-038
3060-001	PEEK Rotor Seal for 3060, 3060-038
3710-008	PEEK Rotor Seal for 3000, 3000-038, 3710, 3710-038
3725-018	PEEK Rotor Seal for 3725, 3725-038
7610-011	PEEK Rotor Seal for 7610-400, 7610-600

### Stator Part Numbers & Descriptions

PART NUMBER	DESCRIPTION
3060-009	Stator for 3060
3060-010	Stator for 3060-038
3725-006	Stator for 3725, 3710-038, 3000-038, 3030-038
3725-085	Stator for 3725-038, 3710-038, 3000-038, 3030-038
7010-040	Stator for 7010, 7125, 7000, 7030, 7040
7010-066	Stator for 7125-081, 7010-087
7060-039	Stator for 7060, 7066
7123-047	Stator for PR/EV500-100
7123-127	Stator for PR/EV750-107
7123-128	Stator for PR/EV700-107
7123-142	Stator for PR/EV500-104
7123-145	Stator for PR/EV550-104
7123-147	Stator for PR/EV550-100
7123-148	Stator for PR/EV500-101
7123-180	Stator for PR703-100
7123-221	Stator for PR753-100
7123-223	Stator for PR/EV700-112
7410-041	Stator for 7410, 7413
7610-048	Stator for 7610-600
7650-002	Stator for PR/EV700-102
7725-010	Stator for 7725
7750-038	Stator for PR/EV700-100
8125-098	Stator for 8125
9060-016	Stator for 9060
9125-043	Stator for 9125, 9010, 9030, 9725
9650-009	Stator for PR/EV750-102
9750-021	Stator for PR/EV750-100

### Tefzel™ Blend Rotor Seal Part Numbers & Descriptions

PART NUMBER	DESCRIPTION
7010-071	Tefzel Rotor Seal for 7010, 7010-087, 7000, 7040
7030-015	Tefzel Rotor Seal for 7030
7060-074	Tefzel Rotor Seal for 7060, 7066, 9060
7125-079	Tefzel Rotor Seal for 7125, 7125-081, 7725
7410-075	Tefzel Rotor Seal for 7410
8125-097	Tefzel Rotor Seal for 8125
9010-051	Tefzel Rotor Seal for 9010
9125-082	Tefzel Rotor Seal for 9125, 9725



## RheBuild® Kits

RheBuild Kits with genuine Rheodyne parts are available for all Rheodyne products. Included in each individualized RheBuild Kit are all parts, tools, and instructions to maintain precision performance of your particular Rheodyne product. RheBuild Kits eliminate individual part ordering.

RheBuild Part Numbers & Descriptions	
PART NUMBER	DESCRIPTION
3725-999	Models 3725, 3725i, 3725-038, 3735i-038
7010-996	Conversion Kit to include Stator Face Assembly for 7010
7010-997	RheBuild Kit to include Stator for 7010
7010-999	Model 7010 and 7010-type Valves
7125-999	Models 7125 and 7126
7410-999	Model 7410
7520-999	Models 7520 and 7526
7725-999	Models 7725 and 7725i
8125-999	Models 8125 and 8126

RheBuild PEEK Valve Part Numbers & Descriptions	
PART NUMBER	DESCRIPTION
9010-999	Model 9010
9125-999	Models 9125 and 9126
9725-999	Models 9725 and 9725i

RheBuild LabPRO® and EV Automated Fluidics Instrument Part Numbers & Descriptions	
PART NUMBER	DESCRIPTION
1001-999	Model PR100-101
1002-999	Model PR100-102
1005-999	Model PR/EV100-105
1006-999	Model PR/EV100-106
5001-999	Models PR/EV500-101 and PR/EV550-101
5100-999	Models PR/EV500-100 and PR/EV550-100
5104-999	Models PR/EV500-104 and PR/EV550-104
7112-999	Models PR/EV700-112 and PR/EV750-112
7501-999	Models PR/EV700-100 and PR/EV750-100
7502-999	Models PR/EV700-102 and PR/EV750-102
7507-999	Models PR/EV700-107 and PR/EV750-107
7531-999	Models PR703-100 and PR753-100
7004-999	Models PR/EV700-104 and PR/EV750-104

Other Part Numbers & Descriptions	
PART NUMBER	DESCRIPTION
5700-999	Models 5701, 5703, 5704
7125Ti-999	Model 7125-081

## Tech Tip #4

### How to Select the Right Rotor Seal

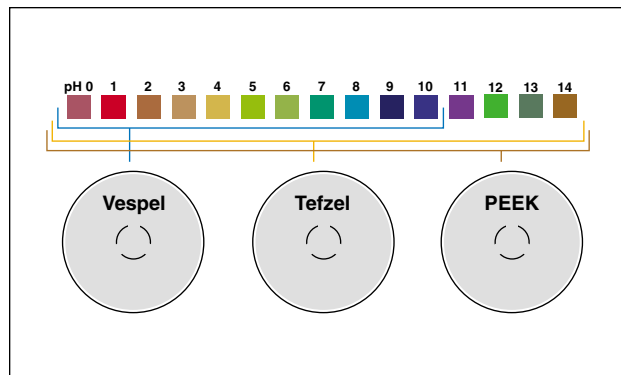

The standard rotor seal in many Rheodyne manual valves is made from a Vespel blend. This polyimide has low wear and high chemical resistance. Vespel tolerates a pH range of 0 to 10. Solutions more basic than pH 10 dissolve Vespel which damages the rotor seal. If you use any solutions above pH 10, Rheodyne recommends a PEEK blend rotor seal. PEEK offers a high chemical resistance and versatility, and will tolerate the entire pH range from 0 to 14. Tefzel blend rotor seals may be appropriate for some applications. Replacement rotor seals are listed on page 20.

Genuine Rheodyne rotor seals are matchless in performance and product life. For a quarter of a century they have exceeded the needs and expectations of chromatographers. Our rotor seals are products of rigid manufacturing and quality assurance procedures before they are incorporated into our valves or shipped to our customers. Only genuine Rheodyne parts ensure the continued precision performance of Rheodyne valves.

Our engineers develop exacting product specifications and designs including the factory-installed rotor seal ring which optimizes rotor seal efficiency. Rheodyne rotor seals must pass our tougher-than-real-world standards of performance. Rheodyne rotor seals are made from proprietary-blended polymers, formulated specifically for resistance to repetitive chemical and physical stresses of the entire 0 to 14 pH range.

Tested under actual laboratory conditions, Rheodyne rotor seals fully meet the demanding requirements of day-to-day manual instrument use as well as the operating conditions found in today's automated laboratories.



Rheodyne accessories are specially designed for Rheodyne products. Only Rheodyne accessories provide the perfect fit and ensure the precision performance of Rheodyne products.

## Needle Port Accessories

Rheodyne's adaptable Loop Filler Ports (Part # 7012 and 9012) are used to load sample from syringe needles or luer tips. The Needle Port (Part # 9013) conserves sample by minimizing the volume between the needle and the valve.

## Syringes and Syringe Needles

A wide variety of Syringes and Syringe Needles offers users many sample volumes and needle sizes to precisely load into Rheodyne sample injectors. Some syringes also fit into the Needle Port Cleaner (Part # 7125-054) for flushing out the needle port. All needles have the proper square cut (90° point style) for LC.

## Mounting Brackets

Rheodyne mounting brackets and panels of different shapes and sizes organize and provide a sturdy support for Rheodyne valves. The Ring Stand Mounting Bracket now allows the valves to mount onto common laboratory equipment.



## Position Sensing Switch

The Position Sensing Switch uses a magnetic reed to make a reproducible start signal to record the injection time in the data system of a chromatograph. This convenient, mountable switch is available for sample injectors without "i" versions.

## Column Inlet Filters

Column Inlet Filters are useful accessories to extract particles from the sample between the injector and the column. Rheodyne offers Filters and Replacement Filter Discs of different ID sizes for low or medium dispersion. Column Connecting Tubes are also available.

## Rheodyne Wrench

The smartly designed Rheodyne Wrench is a double-ended slotted socket wrench that fits over 1/16" and 1/8" ID tubing and loosens and tightens 1/4" and 5/16" stainless steel or PEEK fittings. The "Z" shape of the Rheodyne Wrench provides ideal leverage for changing sample loops and fittings, and keeps one end from restricting the use of the other.



## Needle Port Accessories Part Numbers & Descriptions

PART NUMBER	DESCRIPTION
7012	Stainless Steel Loop Filler Point
9012	PEEK Loop Filler Port
9013	PEEK Needle Port
7125-054	Needle Port Cleaner
9125-076	Suction Needle Adapter (for Model 9725)

## Syringes and Syringe Needles (Square Cut) Part Numbers & Descriptions

PART NUMBER	DESCRIPTION
7200	2.5 $\mu$ L Removable Needle Syringe
7200-003	Replacement Needles for 7200, 3/pkg
7215	#22 gauge Stainless Steel Needle for Luer Tip Syringe
3725-056	#16 gauge PEEK Needle for Luer Tip Syringe
3725-086	#16 gauge Stainless Steel Needle for Luer Tip Syringe
7201	10 $\mu$ L Syringe
7202	25 $\mu$ L Syringe
7205	50 $\mu$ L Syringe
7210	100 $\mu$ L Syringe
7225	250 $\mu$ L Syringe
7250	500 $\mu$ L Syringe
7252	2.5 mL Luer Tip Syringe
7255	5.0 mL Luer Tip Syringe
7260	25 mL Luer Tip Syringe

## Mounting Bracket Accessories Part Numbers & Descriptions

PART NUMBER	DESCRIPTION
5060	Teflon Rotary Valve Mounting Bracket
7160	Mounting Panel
7160-010	Valve Angle Bracket
7160-029	Ring Stand Mounting Bracket
5060-007	"MX" Ring Stand Mounting Bracket

## Miscellaneous Part Numbers & Descriptions

PART NUMBER	DESCRIPTION
6810	Rheodyne Wrench
7161-020	Position Sensing Switch for 7125
7161-016	Position Sensing Switch for 7010, 7410, 7000, 7030, 7040
7165	Position Sensing Switch for 7250
7315	0.5 $\mu$ L pore x 1.5 mm ID Column Inlet Filter
7315-010	Replacement Filter Discs for 7315, 5/pkg
7335	0.5 $\mu$ L pore x 3.0 mm ID Column Inlet Filter
7335-010	Replacement Filter Discs for 7335, 5/pkg
7312-008	0.18 mm ID x 60 mm Connecting Tube
7312-009	0.13 mm ID x 60 mm Connecting Tube

## Tech Tip #5

### Sample Loop Loading: Partial-Filling vs. Complete-Filling

#### Partial-Filling

Use the partial-filling method if you need to conserve sample, or if you want to vary sample volume frequently.

In partial-filling, the syringe sets the volume injected onto the column. There is no sample waste, and the volume injected onto the column is equal to that dispensed from the syringe. Reproducibility is 1.0% relative standard deviation (RSD). The volume of the sample loaded is limited to half the sample loop volume. For example, the most you can load into a 200  $\mu$ L sample loop is 100  $\mu$ L. See Figure 1. This limitation is due to the manner in which fluids move in tubes. Fluidic movement in tubes affects reproducibility. See Tech Tip #6 on page 27.

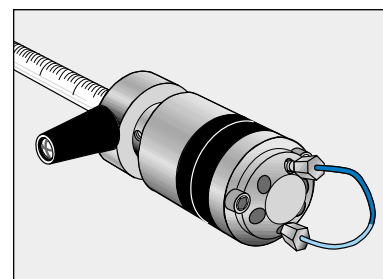

Fig. 1. The sample loop can fill up to half the loaded volume in partial-filling method.

#### Complete-Filling

Use the complete-filling method if you have a sufficient amount of sample with which to work, if you do not vary sample volume, or if you need high reproducibility.

In complete-filling, the loop sets the volume loaded onto the column. You use excess sample (two to five loop volumes) to replace all the mobile phase in the loop. See Figure 2. Change the loop to vary the sample volume. Reproducibility is typically 0.1% RSD for loop sizes  $\geq$  5  $\mu$ L. Accuracy is limited as loop volumes are nominal.

Q: Which method should I use and which Rheodyne sample injectors use this method?

A: There are two types of injectors available: dual mode and single mode. Dual mode injectors allow both partial- and complete-filling whereas single mode injectors allow only complete-filling. See Sample Injectors on pages 12-16.

If you are collecting experimental data, sample is scarce, and/or you want to use different sample volumes, a dual mode injector with a large volume sample loop is appropriate. Only dual mode injectors allow the partial-filling method with which you can easily vary your volumes (up to half your sample loop volume) by setting the syringe volume. Once you begin routine analysis, and/or you have an abundance of sample, either a dual mode or single mode injector is appropriate. Both types of injectors allow complete-filling method with which you fill the sample loop in excess. Complete-filling maximizes the reproducibility of your results.

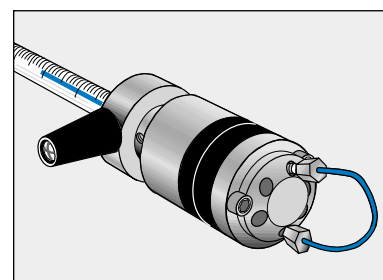

Fig. 2. The sample loop is filled in excess in complete-filling method.

# Sample Loops

Stainless steel and PEEK sample loops are factory-cut and finished to the highest quality. The 316 stainless steel loop ends have a square cut and are burr-free for a flush connection to the valve. The flexible PEEK loop ends are provided with a clean and straight cut for easy installation onto the valve.

Stainless steel (and titanium) sample loops are supplied with unswaged fittings. The two ends of the loop must be completely bottomed in the injector ports before the ferrule is swaged onto the loop. Swaging each end separately and then replacing the ends in their respective ports of the same valve ensure that the loop ends are bottomed into the ports. A fitting made up in one port may leave an undesirable cavity in another port. As all ports vary in all valves, careful attention to loop installation is important.

PEEK loops are also supplied with unswaged RheFlex<sup>®</sup> fittings but do not require the same swaging precaution. The fittings can reposition along the loop tubing when the fitting reinserts in the ports for correct loop installation.



## Stainless Steel and Titanium

Stainless steel and titanium sample loops are available. The size designations of loops are nominal. The actual volumes can differ from the theoretical designations because of the  $\pm 0.025$  mm (0.001") tolerance of the metal tubing bore.

Accuracy of large metal loops (1.0 mm, 0.040" bore) is about  $\pm 5\%$ , intermediate loops (0.5 mm, 0.020" bore)  $\pm 10\%$ , and small loops (0.2 mm, 0.007" bore)  $\pm 30\%$ .

Since both standards and unknowns are usually analyzed using the same sample loop, knowledge of the actual, accurate volume is rarely needed. If the sample loop volume must be known, it is best to calibrate the loop in place on the valve so the flow passages in the valve are also taken into account. An alternative to calibration is to use a dual mode injector and partial-filling method of loading. See Tech Tip #5 on page 23.

Model 8125 Micro-Scale Sample Injector requires special loops in the 5.0  $\mu$ L to 50  $\mu$ L range. The 8125 sample loops are made with 0.5 mm (0.020") OD tubing.

Model 7725 Injector loops are not interchangeable with loops for the Model 7125. The port angle for the 7725 is 30° whereas the port angle for the 7125 is 20° requiring the loops to have a different shape.

Titanium loops for Models 7125-081 and 7010-087 are available by consulting your authorized Rheodyne distributor.

Stainless Steel Loops for 3725-038 and 3725i-038 Injectors Part Numbers & Descriptions		
PART NUMBER	DESCRIPTION	BORE
3065-018	2.0 mL Sample Loop	2.0 mm (0.080")
3065-019	5.0 mL Sample Loop	2.0 mm (0.080")
3065-023	10 mL Sample Loop	2.0 mm (0.080")
3065-025	20 mL Sample Loop	2.0 mm (0.080")

Stainless Steel Loops for 7725, 7725i, PR/EV700-100 and PR/EV703-100 Injectors Part Numbers & Descriptions (Do not use for 7125).		
PART NUMBER	DESCRIPTION	BORE
7755-020	5 $\mu$ L Sample Loop	0.18 mm (0.007")
7755-021	10 $\mu$ L Sample Loop	0.30 mm (0.012")
7755-022	20 $\mu$ L Sample Loop	0.30 mm (0.012")
7755-023	50 $\mu$ L Sample Loop	0.51 mm (0.020")
7755-024	100 $\mu$ L Sample Loop	0.51 mm (0.020")
7755-025	200 $\mu$ L Sample Loop	0.76 mm (0.030")
7755-026	500 $\mu$ L Sample Loop	0.76 mm (0.030")
7755-027	1.0 mL Sample Loop	0.76 mm (0.030")
7755-028	2.0 mL Sample Loop	1.0 mm (0.040")
7755-029	5.0 mL Sample Loop	1.0 mm (0.040")

Stainless Steel Loops for 7125 and 7010 Injectors Part Numbers & Descriptions (Do not use for 7725).		
PART NUMBER	DESCRIPTION	BORE
7020	5 $\mu$ L Sample Loop	0.18 mm (0.007")
7021	10 $\mu$ L Sample Loop	0.30 mm (0.012")
7022	20 $\mu$ L Sample Loop	0.51 mm (0.020")
7023	50 $\mu$ L Sample Loop	0.51 mm (0.020")
7024	100 $\mu$ L Sample Loop	0.51 mm (0.020")
7025	200 $\mu$ L Sample Loop	0.76 mm (0.030")
7026	500 $\mu$ L Sample Loop	0.76 mm (0.030")
7027	1.0 mL Sample Loop	0.76 mm (0.030")
7028	2.0 mL Sample Loop	1.0 mm (0.040")
7029	5.0 mL Sample Loop	1.0 mm (0.040")

Stainless Steel Loops for 8125 Injector Part Numbers & Descriptions (Use 7755-024 to 7755-029 for volumes < 50 $\mu$ L).		
PART NUMBER	DESCRIPTION	BORE
8020	5 $\mu$ L Sample Loop	0.20 mm (0.008")
8021	10 $\mu$ L Sample Loop	0.20 mm (0.008")
8022	20 $\mu$ L Sample Loop	0.25 mm (0.010")
8023	50 $\mu$ L Sample Loop	0.30 mm (0.012")



## PEEK

PEEK sample loops are alternatives to stainless steel loops. The material is inert to almost all organic solvents and is biocompatible which gives PEEK loops added versatility. Rheodyne uses natural PEEK for these sample loops. This means no dye leaching into your sample. Like metal loops, the size designations of PEEK loops are nominal. The actual volumes can differ from the theoretical designations because of the  $\pm 0.05$  mm (0.002") tolerance of the tubing bore. Accuracy of large PEEK loops (0.8 mm, 0.030" bore) is about  $\pm 14\%$ , intermediate loops (0.5 mm, 0.020")  $\pm 21\%$ , and small loops (0.2 mm, 0.007")  $\pm 65\%$ .

### PEEK Physical Strength Characteristics

Although PEEK material is compatible with virtually all solvents, there are many factors that affect burst pressure of PEEK tubing. Factors such as increases in inner diameter, temperature, exposure time, and concentration of organic solvents affect the degradation of PEEK. Other solvents such as THF, methylene chloride, and DMSO cause PEEK tubing to swell while concentrated nitric acid and sulfuric acid weaken tubing.

### PEEK Loops for 3725 and 3725i Injectors Part Numbers & Descriptions

PART NUMBER	DESCRIPTION	BORE
3055-018	2.0 mL Sample Loop	1.6 mm (0.062")
3055-019	5.0 mL Sample Loop	1.6 mm (0.062")
3055-023	10 mL Sample Loop	2.0 mm (0.080")
3055-025	20 mL Sample Loop	2.0 mm (0.080")

### PEEK Loops for 9725, 9010, PR/EV750-100 and PR/EV753-100 Injectors Part Numbers & Descriptions

PART NUMBER	DESCRIPTION	BORE
7123-227	1 $\mu$ L Sample Loop (Model PR/EV750-100 only)	internal groove
7755-015	2 $\mu$ L Sample Loop (9725 only)	internal groove
9055-020	5.0 $\mu$ L Sample Loop	0.18 mm (0.007")
9055-021	10 $\mu$ L Sample Loop	0.25 mm (0.010")
9055-022	20 $\mu$ L Sample Loop	0.25 mm (0.010")
9055-023	50 $\mu$ L Sample Loop	0.51 mm (0.020")
9055-024	100 $\mu$ L Sample Loop	0.51 mm (0.020")
9055-025	200 $\mu$ L Sample Loop	0.51 mm (0.020")
9055-026	500 $\mu$ L Sample Loop	0.76 mm (0.030")
9055-027	1.0 mL Sample Loop	0.76 mm (0.030")
9055-028	2.0 mL Sample Loop	0.76 mm (0.030")
9055-029	5.0 mL Sample Loop	0.76 mm (0.030")
9055-033	10 mL Sample Loop	0.76 mm (0.030")

### PEEK Loops for 7725, 7725i, and PR/EV700-100 Injectors Part Numbers & Descriptions

PART NUMBER	DESCRIPTION	BORE
7123-227	1 $\mu$ L Sample Loop (Model PR/EV700-100 only)	internal groove
7755-015	2 $\mu$ L Sample Loop (Models 7725 and 7725i only)	internal groove



## ChromTRAC

- Brightly colored knobs and ChromTRAC mapping code fluid connections
- Easily track inlets and outlets of valves, columns, and detectors
- Dyed colors stay out of fluid stream

Rheodyne's innovative ChromTRAC color-coding system is the industry standard for simplifying your fluid connections. Seven ChromTRAC colors clearly identify tubing lines and visually distinguish different components in the same system. Combined with unique ChromTRAC mapped valves, the colored knobs on RheFlex® Fittings allow you to coordinate port to fittings to system component without confusion. Figure 15 shows an example of a ChromTRAC mapped valve. The mapping indicates the color standard of the ChromTRAC color-coded RheFlex fitting to be used in each port.

ChromTRAC is available in a Fittings Identification Kit, a 20 pack of multi-colored knobs. The Fittings Identification Kit contains 20 ChromTRAC knobs in black (2), white (2), green (2), grey (2), yellow (4), red (4), and blue (4). These replaceable ChromTRAC knobs are compatible with RheFlex One-Piece; 10-32, 1/16" RheFlex PEEK; all 1/4-28 RheFlex TF; and all 1/4-28 RheFlex Flangeless Fittings.

All RheFlex fittings listed above have the ChromTRAC knob option at the time of ordering by specifying the ChromTRAC two letter suffix for the color choice. ChromTRAC Suffix Codes below lists the color codes. "MC" refers to "multi-color" which includes two each of blue, green, grey, red, and yellow.

*View the online product product bulletin - <http://www.rheodyne.com/2320626A.html>*

## ChromTRAC - Fittings Identification Kit

ChromTRAC is available in a Fittings Identification Kit, a 20 pack of multi-colored knobs. The Fittings Identification Kit contains 20 ChromTRAC knobs in black (2), white (2), green (2), grey (2), yellow (4), red (4), and blue (4). These replaceable ChromTRAC knobs are compatible with RheFlex One-Piece; 10-32, 1/16" RheFlex PEEK; all 1/4-28 RheFlex TF; and all 1/4-28 RheFlex Flangeless Fittings.

All RheFlex fittings listed above have the ChromTRAC knob option at the time of ordering by specifying the ChromTRAC two letter suffix for the color choice. ChromTRAC Suffix Codes chart lists the color codes. "MC" refers to "multi-color" which includes two each of blue, green, grey, red, and yellow.

*View the online product product bulletin - <http://www.rheodyne.com/2320626A.html>*

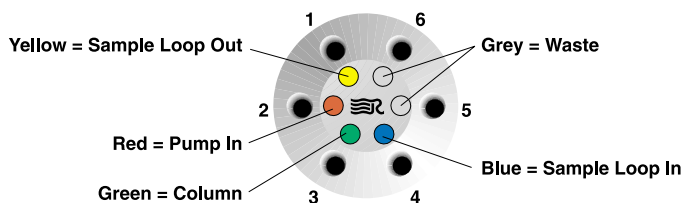
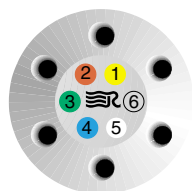
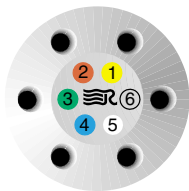

Fig. 15. Typical 2-Position, 6-Port plumbing connections color-coded using ChromTRAC. ChromTRAC makes plumbing simple.



7725(i), 9725(i), 8125(i), 7125



7010, 9010



7610 - 400/600

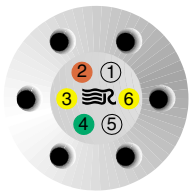

7040

Examples of ChromTRAC Mapping Standards.

ChromTRAC Suffix Codes			
CODE	COLOR	CODE	COLOR
BL	Blue	GN	Green
GY	Gray	RD	Red
WH	White	YL	Yellow
MC	Multi-color (available in 10-packs only)		

Add these two letter suffixes to the end of the seven-digit part numbers of the fittings listed with \*.

ChromTRAC Fitting Knobs Part Numbers & Descriptions	
PART NUMBER	DESCRIPTION
6000-283	ChromTRAC Fitting Identification Kit, 20/pkg

## Tech Tip #6

### Fluidic Movement in Tubes

Q: Why can I load only up to half of the volume of the loop in partial-filling method?†

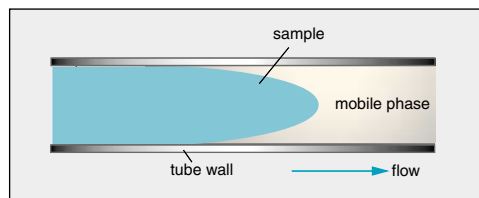

Fig. 1. Schematic of sample flow through mobile phase between tubing walls.

A: Sample occupies 2  $\mu\text{L}$

of loop for every 1  $\mu\text{L}$  loaded from the syringe. For example, 10  $\mu\text{L}$  of sample spreads out over the entire length of a 20  $\mu\text{L}$  loop. Any more sample loaded will overflow the end of the loop and exit out to waste. Reproducibility is poor because the volume of sample in the loop is different from the known volume originally loaded by your syringe.

Fluid spreads in a parabolic shape through a tube instead of moving in one plug because the velocity is different at the center of the tube than at the walls. The velocity at the center of the tube is twice the average velocity, and near the wall the velocity is almost zero, creating a parabolic shape. This fluidic movement is called laminar flow. See Figure 1.

In dual mode injectors (see Tech Tip #5 on page 23) the sample from the syringe needle loads directly into the sample loop. The sample volume is known since there is no sample waste. The laminar flow phenomenon accounts for the shape of the plot as shown in Figure 2. Note that the plot has three regions:

a) Partial-Filling Region.

When the volume dispensed is less than half the loop volume, the curve is linear. Sample has not reached the end of the loop. Within this region, performance depends on the syringe and operator.

b) Nonlinear Region.

When the volume dispensed is between half the loop volume and about two loop volumes, the curve is nonlinear. Sample is lost from the

loop, so reproducibility is poor. If you dispense a volume equal to the loop size, you are in this region of poor performance.

c) Complete-Filling Region. When the volume of sample dispensed is several loop volumes, the loop contains only pure sample, undiluted by residual mobile phase. Within this region, reproducibility is highest.

In the single mode injectors the sample must pass through a connecting passage before it reaches the sample loop. Since some of the sample dispensed from the syringe remains in the connecting passageway, an unknown amount enters the sample loop. Therefore, single mode injectors achieve high reproducibility only by using the complete-filling method.

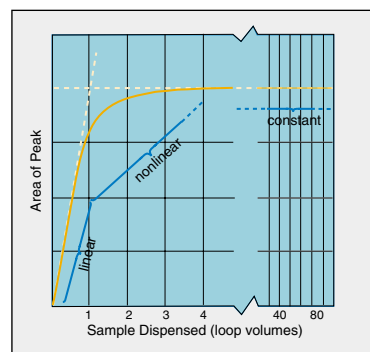

Fig. 2. Sample mass (observed peak area) vs. volume of sample dispensed from the syringe, in units of loop volumes, injected onto the column from a Rheodyne dual mode injector such as Model 7725.



RheFlex One-Piece Fittings for Cone-Bottom Ports



RheFlex Two-Piece PEEK Fittings for Cone-Bottom Ports



RheFlex Twist-Free (TF) Fittings for Flat-Bottom Ports

## RheFlex One-Piece Finger Tight

RheFlex One-Piece Finger Tight fitting eliminates the need for separate nuts and ferrules. The convenience of one-piece fittings makes valve plumbing easier and faster. Rheodyne's 10-32, 1/16" One-Piece fitting can be used with stainless steel, PEEK, and Teflon® tubing. The One-Piece fittings include the ChromTRAC knobs in the color of your choice for visual identification and finger tightening of fluid connections. The reusable One-Piece fitting can be finger tightened to hold 34 MPa (345 bar, 5000 psi).

## RheFlex Precision Two-Piece Fittings for Cone-Bottom Ports

RheFlex Precision Two-Piece PEEK fittings sets provide inert, biocompatible connections for instrumentation. These dependable 1/16" PEEK fittings have a reliable, time-tested design. Each 1/16" fittings set contains a 10-32 threaded nut and a ferrule. Three lengths of the 1/16" nut are available: Standard (24 mm [0.96"]), Short (14 mm [0.56"]), and Extra Long (33 mm [1.32"]).

Due to the unique RheFlex gripping design, the 1/16" ferrule will hold onto PEEK and stainless steel tubing to hold 48 MPa (483 bar, 7000 psi). The RheFlex PEEK nut and ferrule can be reused many times.

RheFlex PEEK fittings include the ChromTRAC knobs in the color of your choice for visual identification and finger tightening of fluid connections without undesirable twisting of the PEEK tubing. See Tech Tip #8 on page 31. Replacement 1/16" RheFlex PEEK ferrules and ChromTRAC knobs are available.

View the online product product bulletin - <http://www.rheodyne.com/2320626A.html>

## RheFlex Twist-Free (TF) Fittings for Flat-Bottom Ports

RheFlex Twist-Free fittings sets allow twist-free tubing connections for all flat-bottom ports. TF fittings are available in 1/16" and 1/8" with nuts containing 1/4-28 threads. The RheFlex TF fittings are capable of high pressure connections.

The nut snaps onto the ferrule while the fitting is screwed into the port. Since the nut and the ferrule snap together, the fittings remain firmly on the tubing instead of sliding down during disconnection.

The 1/16" RheFlex TF fittings using PEEK tubing can be wrench-tightened to 48 MPa (483 bar, 7000 psi). When using Teflon tubing, the 1/16" TF fittings can be finger tightened to 6.8 MPa (68 bar, 1000 psi). The 1/8" RheFlex TF fittings using PEEK tubing can be wrench-tightened to 28 MPa (276 bar, 4000 psi). When using Teflon tubing, the 1/8" TF fittings can be finger tightened to 5.1 MPa (51 bar, 750 psi).

RheFlex TF fittings include the ChromTRAC knobs in the color of your choice for visual identification and finger tightening of fluid connections. Replacement 1/16" and 1/8" RheFlex TF ferrules and ChromTRAC knobs are available.

View the online product product bulletin - <http://www.rheodyne.com/2320626A.html>

### RheFlex One-Piece Fittings for Cone-Bottom Ports Part Numbers & Descriptions

PART NUMBER	DESCRIPTION
6000-282	10-32, 1/16" RheFlex One-Piece Finger Tight PEEK, 10/pkg*

### RheFlex Two-Piece PEEK Fittings for Cone-Bottom Ports Part Numbers & Descriptions

PART NUMBER	DESCRIPTION
6000-054	10-32, 1/16" RheFlex PEEK Fittings Set, 5/pkg*
6000-254	10-32, 1/16" RheFlex PEEK Fittings Set, 10/pkg*
6000-055	10-32, 1/16" RheFlex PEEK Short Fittings Set, 5/pkg
6000-255	10-32, 1/16" RheFlex PEEK Short Fittings Set, 10/pkg
6000-066	10-32, 1/16" RheFlex PEEK Extra Long Fittings Set, 1/pkg*
6000-051	10-32, 1/16" RheFlex PEEK Ferrules, 5/pkg
6000-251	10-32, 1/16" RheFlex PEEK Ferrules, 10/pkg

### RheFlex Twist-Free (TF) Fittings for Flat-Bottom Ports Part Numbers & Descriptions

PART NUMBER	DESCRIPTION
6000-274	1/4-28, 1/8" RheFlex TF Fittings Set, 10/pkg*
6000-275	1/8" RheFlex TF Ferrules, 10/pkg
6000-276	1/4-28, 1/16" RheFlex TF Fittings Set, 10/pkg*
6000-277	1/16" RheFlex TF Ferrules, 10/pkg

\* ChromTRAC compatible. Specify the two letter suffix (see ChromTRAC Suffix Codes) after the fitting's seven-digit part number for the ChromTRAC knob color of your choice. No suffix indicates black knobs.



RheFlex Flangeless Fittings for Flat-Bottom Ports

## RheFlex Flangeless Fittings for Flat-Bottom Ports

RheFlex Flangeless fittings sets are economical, easy-to-install fittings for all flat-bottom ports. Rheodyne's flangeless fittings are available in both 1/16" and 1/8" with nuts containing 1/4-28 threads. This two-piece fittings set contains a PEEK nut and a Tefzel® ferrule which makes fittings replacement simple.

The 1/16" RheFlex Flangeless with Teflon® tubing can be finger tightened to hold 4.7 MPa (47.6 bar, 700 psi). When using PEEK tubing, the 1/16" Flangeless fitting can hold 21 MPa (207 bar, 3000 psi). The 1/8" RheFlex Flangeless with Teflon tubing can be finger tightened to hold 3.4 MPa (34 bar, 500 psi). When using PEEK tubing, the 1/8" Flangeless fitting can hold 5.4 MPa (54.4 bar, 800 psi).

RheFlex Flangeless fittings include the ChromTRAC knobs in the color of your choice for visual identification and finger tightening of fluid connections. Replacement 1/16" and 1/8" RheFlex Flangeless ferrules and ChromTRAC knobs are available.

View the online product product bulletin - <http://www.rheodyne.com/2320626A.html>

ChromTRAC Suffix Codes	
CODE	COLOR
BL	Blue
GN	Green
GY	Grey
RD	Red
WH	White
YL	Yellow
MC	Multi-color (for 10/pkg only)

Add these two letter suffixes to the end of the seven-digit part numbers of the fittings listed with \*.

RheFlex Flangeless Fittings for Flat-Bottom Ports Part Numbers & Descriptions	
PART NUMBER	DESCRIPTION
6000-278	1/4-28, 1/8" RheFlex Flangeless, 10/pkg*
6000-279	1/8" RheFlex Flangeless, 10/pkg
6000-280	1/4-28, 1/16" RheFlex Flangeless, 10/pkg*
6000-281	1/16" RheFlex Flangeless, 10/pkg

\* ChromTRAC compatible. Specify the two letter suffix (see ChromTRAC Suffix Codes) after the fitting's seven-digit part number for the ChromTRAC knob color of your choice. No suffix indicates black knobs.

## Tech Tip #7

### How to Properly Install Sample Loops



Fig. 1. Cut-away view of stainless steel sample loop installation.

#### Stainless Steel

Stainless steel sample loops are supplied with fittings that are unswaged onto the tube. It is important that the loop be completely bottomed in the injector port before the ferrule is swaged onto the tube. The depth of the tubing holes may vary slightly from port to port and from valve to valve. A fitting made up in one port may leave a small cavity in another port. The cavity causes high dispersion and peak distortion such as fronting, tailing, or broadening. It is good practice to label loop ends so they will be replaced in the same, respective ports that were used in swaging the ferrules. Hint: swaging ferrules separately on each side, into each respective valve port makes loop installation easier.

To install the sample loop:

- Take one end of the loop and place the nut (1) and ferrule (2) onto the tubing (3) with the threaded portion of the nut and tapered portion of the ferrule toward the end. See Figure 1A.
- Insert the tubing into port (4). Confirm that the tubing is bottomed in the valve port as shown in Figure 1A.
- While firmly pressing down on the tubing, hand-tighten the nut as tight as possible.
- With the Rheodyne Wrench (see page 22), designed especially for fittings, tighten one 90 turn past finger tight. Remove the loop to confirm that the ferrule is swaged onto the tube.
- Repeat steps a-d with the other end of the loop while the swaged end remains outside the valve port. See Figure 1B.
- Reinstall each end of the loop to their respective ports. See Figure 1C.

#### RheFlex/EPEEK Fittings and PEEK Tubing

PEEK loop installation requires steps a-c in the stainless steel section above. Finger tightening of PEEK fittings is adequate to make a leak-free connection. The slotted backside of the ferrule (1) is squeezed down onto the tube (2) by the mating conical surface in the nut (3). See Figure 2. The nut and ferrule can

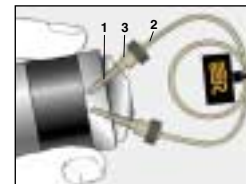
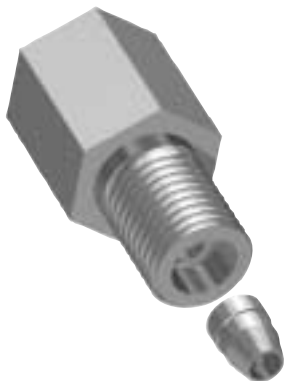

Fig. 2. Cut-away view of PEEK sample loop installation.

both be reused many times. Unlike ordinary fittings, the unique RheFlex PEEK design, specifically the angles and surface contacts between the ferrule and nut, prevents the nut from gripping the ferrule and twisting both the ferrule and the tube during tightening. Otherwise, such twisting stresses the PEEK tubing and lowers the pressure rating of the tubing.

The ferrule can slide and reposition itself along the tube when the fitting is reinserted into a port. It is important that the PEEK tubing is completely bottomed in the injector port before the fittings are tightened to avoid leaving an undesired cavity. Both stainless steel and PEEK sample loops are listed on pages 24-25.



## RheFlex Stainless Steel Fittings for Cone-Bottom Ports

RheFlex 316 stainless steel fittings sets can be used in Rheodyne stainless steel valves and sample loops. Each 1/16" fittings set contains a 10-32 threaded nut and a ferrule. Three lengths of the 1/16" nut are available: Standard (9.7 mm [0.38"]), Long (13.5 mm [0.53"]), and Extra Long (17.0 mm [0.67"]). Rheodyne recommends Extra Long nuts for fittings that are frequently disconnected, especially when space is restricted. RheFlex stainless steel fittings must be wrench-tightened. Replacement stainless steel ferrules are available.

ChromTRAC knobs from the ChromTRAC Fittings Identification Kit fit over stainless steel nuts for color-coding fluid connections.

Consult Rheodyne factory for titanium fittings.

*View the online product product bulletin - <http://www.rheodyne.com/2320626A.html>*

## 5/16-24, 1/8" RheFlex Fittings for Cone-Bottom Ports

RheFlex stainless steel and PEEK fittings are available in 1/8" with nuts containing 5/16-24 threads. These 1/8" fittings sets can be used in all Rheodyne preparative scale valves. Both the 316 stainless steel fittings and RheFlex PEEK fittings must be wrench-tightened.

Due to the unique RheFlex gripping design, the 1/8" ferrule will hold onto PEEK and stainless steel tubing to hold 34 MPa (345 bar, 5000 psi) without undesirable twisting of the tubing. See Tech Tip #8 on page 31. Replacement 1/8" Stainless Steel and PEEK ferrules are available.

A 5/16-24 to 10-32 Adapter is also available. The Adapter allows a 1/16" RheFlex fitting to fit in an 1/8" valve port without causing dead volume.

*View the online product product bulletin - <http://www.rheodyne.com/2320626A.html>*

**Table V. Pressure Ratings of RheFlex Fittings.**

RHEFLEX FITTING	WRENCH-TIGHTEN MPa (bar, psi)	FINGER TIGHTEN MPa (bar, psi)
One-Piece Finger Tight	N/A	34 (345, 5000)
1/16" PEEK for Cone-Bottom Ports	48 (483, 7000)	N/A
1/16" Stainless Steel for Cone-Bottom Ports	68 (690, 10,000)	N/A
1/16" Twist-Free for Flat-Bottom Ports	48 (483, 7000) with PEEK tubing	6.8 (68, 1000) with PTFE tubing
1/8" Twist-Free for Flat-Bottom Ports	28 (276, 4000) with PEEK tubing	5.1 (51, 750) with PTFE tubing
1/16" Flangeless for Flat-Bottom Ports	21 (207, 3000) with PEEK tubing	4.7 (47.6, 700) with PTFE tubing
1/8" Flangeless for Flat-Bottom Ports	5.4 (54.4, 800) with PEEK tubing	3.4 (34, 500) with PTFE tubing
1/8" PEEK for Cone-Bottom Ports	34 (345, 5000)	N/A
1/8" Stainless Steel for Cone-Bottom Ports	34 (345, 5000)	N/A



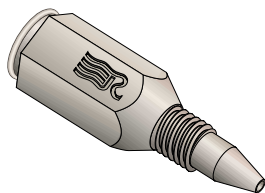

## RheFlex M4 Fittings for Cone-Bottomed Ports

RheFlex M4 fittings are available in PEEK. Each fitting has a one piece design, which eliminates the need for a separate nut and ferrule. The Rheodyne M4 fitting design provides dependable zero dead volume connections for micro and nano applications. Due to the unique RheFlex gripping design, the M4 fittings will hold onto PEEK or fused silica tubing to hold 34 MPa (345 bar or 5000 psi). PEEK M4 plugs are also available.

RheFlex M4 Fittings for Cone-Bottom Ports	
PART NUMBER	DESCRIPTION
6000-360	M4 RheFlex PEEK Fittings, 10/pkg
6000-361	M4 RheFlex PEEK Plugs, 10/pkg

RheFlex Stainless Steel Fittings for Cone-Bottom Ports Part Numbers & Descriptions	
PART NUMBER	DESCRIPTION
6000-109	10-32, 1/16" RheFlex SST Fittings Set, 5/pkg
6000-209	10-32, 1/16" RheFlex SST Fittings Set, 10/pkg
6000-111	10-32, 1/16" RheFlex SST Long Fittings Set, 5/pkg
6000-211	10-32, 1/16" RheFlex SST Long Fittings Set, 10/pkg
6000-162	10-32, 1/16" RheFlex SST Extra Long Fittings Set, 5/pkg
6000-262	10-32, 1/16" RheFlex SST Extra Long Fittings Set, 10/pkg
6000-110	1/16" RheFlex SST Ferrule, 5/pkg
6000-210	1/16" RheFlex SST Ferrule, 10/pkg
8125-084	0.5 mm (0.02") RheFlex SST Ferrule, 1/pkg (for Model 8125 only)

RheFlex 5/16-24, 1/8" Fittings for Cone-Bottom Ports Part Numbers & Descriptions	
PART NUMBER	DESCRIPTION
6000-082	5/16-24, 1/8" RheFlex SST Fittings Set, 1/pkg
6000-083	1/8" RheFlex SST Ferrules, 5/pkg
6000-078	5/16-24, 1/8" RheFlex PEEK Fittings Set, 1/pkg
6000-079	1/8" RheFlex PEEK Ferrules, 5/pkg

RheFlex Fittings Accessories Part Numbers & Descriptions	
PART NUMBER	DESCRIPTION
6000-090	10-32 RheFlex PEEK Plugs, 5/pkg
6510	1/4-28 Coupling, 5/pkg
6518	1/4-28 Plug, 5/pkg
6019	1/4-28 Male to Female Luer Adapter, 1/pkg
6000-076	5/16-24 Male to 10-32 Female Adapter PEEK, 1/pkg
6810	Rheodyne Wrench

## Tech Tip #8

### How to Properly Install Fittings

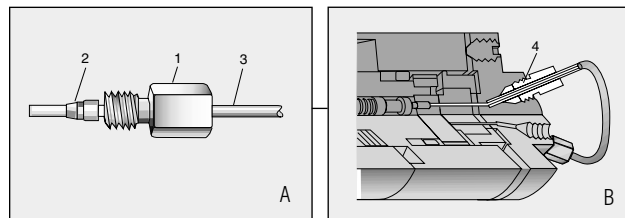

Fig. 1. Cut-away view of stainless steel fittings installation.

#### RheFlex Stainless Steel and Titanium

A good square-cut, burr-free end on tubing is important for use in your system. The square-cut makes a flat surface for the tube to make contact against the bottom of the valve port. Without this contact, a cavity will form which causes high dispersion and peak distortion such as fronting, tailing, or broadening.

To install the tubing:

- Place the nut (1) and ferrule (2) with threaded portion of the nut and tapered portion of the ferrule onto the tubing (3). See Figure 1A.
- Insert the tubing into the valve port (4). Confirm that the tubing is bottomed in the valve port as shown in Figure 1B.
- While firmly pressing down on the tubing, finger tighten the nut as tight as possible.
- With the Rheodyne Wrench (see page 22), designed especially for fittings, tighten one 90° turn past finger tight. Remove the fitting to confirm that the ferrule is swaged onto the tube.

#### RheFlex PEEK Fittings and PEEK Tubing

PEEK tubing is flexible and easy to cut with a sharp blade. Confirm that the ends are clean and straight, and that the inner passage is fully open. To install the tubing follow steps a-c in the stainless steel section above. Finger tightening of 1/16" PEEK fittings is adequate to make a leak-free connection. The 1/8" PEEK fittings need to be wrench-tightened. The slotted backside of the ferrule (1) is squeezed down onto the tube (2) by the mating conical surface in the nut (3). See Figure 2. The nut and ferrule can both be reused many times. Unlike ordinary PEEK fittings, Rheodyne's unique RheFlex PEEK design, specifically the angles and surface contacts between the ferrule and nut, prevents the nut from gripping the ferrule and twisting both the ferrule and the tube during tightening. Otherwise, such twisting stresses the PEEK tubing and lowers the pressure rating of the tubing. See RheFlex Fittings on pages 28-31.

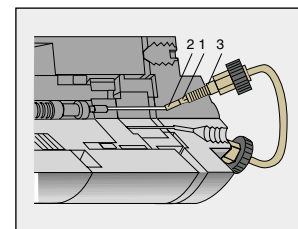

Fig. 2. Cut-away view of PEEK fittings installation.

# Index

Product Number	Page	Product Number	Page	Product Number	Page	Product Number	Page
1001-999	21	6000-255	28	7125-047	20	7755-022	24
1002-999	21	6000-262	31	7125-054	23	7755-023	24
1005-999	21	6000-274	28	7125-079	20	7755-024	24
1006-999	21	6000-275	28	7125-999	21	7755-025	24
		6000-276	28	7125Ti-999	21	7755-026	24
3000	17	6000-277	28	7160	23	7755-027	24
3000-038	17	6000-278	29	7160-010	23	7755-028	24
3030	17	6000-279	29	7160-029	23	7755-029	24
3030-005	20	6000-280	29	7161-016	23		
3030-038	17	6000-281	29	7161-020	23	8020	24
3055-018	25	6000-282	28	7165	23	8021	24
3055-019	25	6000-283	27	7200	23	8022	24
3055-023	25	6019	31	7200-003	23	8023	24
3055-025	25	6510	31	7201	23	8125	13
3060	19	6518	31	7202	23	8125-038	20
3060-001	20	6810	23, 31	7205	23	8125-084	31
3060-009	20			7210	23	8125-097	20
3060-010	20	7000	17	7215	23	8125-098	20
3060-038	19	7000L	17	7225	23	8125-999	21
3065-018	24	7004-999	21	7250	23		
3065-019	24	7010-039	20	7252	23	9010	17
3065-023	24	7010-040	20	7255	23	9010-051	20
3065-025	24	7010-066	20	7260	23	9010-999	21
3710-008	20	7010-071	20	7312-008	23	9012	23
3725	16	7010-996	21	7312-009	23	9013	23
3725i	16	7010-997	21	7315	23	9030	17
3725-006	20	7010-999	21	7315-010	23	9055-020	25
3725-018	20	7012	23	7335	23	9055-021	25
3725-038	16	7020	24	7335-010	23	9055-022	25
3725i-038	16	7021	24	7410	15	9055-023	25
3725-056	23	7022	24	7410-038	20	9055-024	25
3725-085	20	7023	24	7410-041	20	9055-025	25
3725-086	23	7024	24	7410-070	15	9055-026	25
3725-999	21	7025	24	7410-071	15	9055-027	25
		7026	24	7410-072	15	9055-028	25
5001-999	21	7027	24	7410-073	15	9055-029	25
5060	23	7028	24	7410-075	20	9055-033	25
5060-007	23	7029	24	7410-999	21	9060	19
5100-999	21	7030	17	7413-013	20	9060-016	20
5104-999	21	7030L	17	7501-999	21	9125-043	20
5700-999	23	7030-003	20	7502-999	21	9125-076	23
		7030-015	20	7507-999	21	9125-082	20
6000-051	28	7040	19	7520	15	9125-999	21
6000-054	28	7040L	19	7520-011	15	9650-009	20
6000-055	28	7060	19	7520-012	15	9725	12
6000-066	28	7060L	19	7520-013	15	9725i	12
6000-076	31	7060-039	20	7520-999	21	9725-999	21
6000-078	31	7060-070	20	7531-999	21	9750-021	20
6000-079	31	7060-074	20	7610-011	20		
6000-082	31	7112-999	21	7610-048	20	MX7900-000	8
6000-083	31	7123-047	20	7610-400	17	MX7960-000	8
6000-090	31	7123-127	20	7610-600	17	MX7980-000	6
6000-109	31	7123-128	20	7650-002	20	MX7984-000	6
6000-110	31	7123-142	20	7725	12	MX7925-000	7
6000-111	31	7123-145	20	7725i	12	MX7986-000	7
6000-162	31	7123-147	20	7725-010	20	MX9900-000	8
6000-209	31	7123-148	20	7725-999	21	MX9925-000	7
6000-210	31	7123-180	20	7750-038	20	MX9960-000	8
6000-211	31	7123-221	20	7755-015	25		
6000-251	28	7123-223	20	7755-020	24		
6000-254	28	7123-227	25	7755-021	24		

Now it's easier than ever  
to get the information you need...

@ [rheodyne.com](http://rheodyne.com)



- Up-to-date distributor listings
- Detailed product descriptions
- Informative product bulletins
- In-depth technical support
- Application support

Rheodyne's library of technical literature contains useful information for both laboratory researchers as well as OEM instrument designers.

#### PRODUCT BULLETINS

Product specific. They discuss benefits, innovations, quality and performance. Included in product bulletins are operating specifications and illustrated flow paths.

#### PRODUCT NOTES

Product Notes contain information on a variety of topics from sample injection for micro bore columns to selected Rheodyne flow path architectures.

#### TECHNICAL NOTES

Technical Notes are true "How To" publications and detail such topics as how to properly make tube connections, how to use column selection valves, pressure drops of platforms and tubes, and use of column inlet filters.

#### OPERATING INSTRUCTIONS

Operating Instructions provide complete product descriptions, installation instructions, proper maintenance, disassembly, re-assembly, important safety notices, and warranty information.

#### TROUBLESHOOTING GUIDE

Troubleshooting Guide is an extensive publication containing a wealth of information on such topics as leaks, artifact peaks, pressure drops, and other areas to maintain the precision performance of Rheodyne manual platforms.

Rheodyne's easy-to-navigate web site places over 230 pages of product and technical information at your fingertips. Convenient pull down menus include Products, Technical Support, Applications Support, and OEM Instrument Design. Home page links include What's New, Catalog, Literature, Distributors, About Rheodyne, Employment, and Contact Us. If you know what you are looking for, simply use the built-in key word search engine to navigate directly to what you need.

## How can we help you?

That's easy. All product applications are fully illustrated, annotated, and contain a table of application specific valve solutions. Tables contain links to view and download needed Product Bulletins and Operating Instructions. Application discussions include links to Rheodyne literature and publications as well as handy "Tech Tips". Need more help? Technical, application, and OEM design support e-mail forms are included.

To get a copy of the free Rheodyne Troubleshooting Guide CD,  
simply fill out and return the Business Reply Card  
found in this publication.





RHEODYNE  
OFFICES

World Headquarters

Rheodyne LLC  
PO Box 1909  
Rohnert Park, CA  
94927-1909 USA  
T: 707.588.2000  
F: 707.588.2020

Western Regional USA

Rheodyne LLC  
PO Box 1909  
Rohnert Park, CA  
94927-1909 USA  
T: 707.588.2000  
F: 707.588.2020

Eastern Regional USA

Rheodyne LLC  
1226 Sacandaga Road  
West Charlton, NY  
12010 USA  
T: 518.399.9382  
F: 518.384.3229

Europe

Rheodyne Europe GmbH  
Berliner Ring 89  
D-64625 Bensheim  
Germany  
T: +49 6251 6101 15  
F: +49 6251 6101 22