

TO PROTECT YOUR HEALTH

SMART CAPS



A.I.T. France's head office is located at Houilles near Paris. It occupies more than 1000 m² of workshop and offices, production and distribution facilities.



Order may be placed by phone, fax, email. When placing your order, please, have the following informations available :

- ▶ Name.
- ▶ Company name, billing and shipping addresses.
- ▶ Purchase order number.
- ▶ Catalogue number and product description.
- ▶ Size, quantity and unit of measure.

Place an order with our customer service staff in English or French between 9:00 am and 5:30 pm, Monday through Friday.

- ▶ By Phone : +33 (0) 1 34 93 10 80

Orders may be faxed to the following number 24hrs a day, 7 days a week.

- ▶ By Fax : +33 (0) 1 34 93 45 67
- ▶ By Email : aitfrance@aitfrance.fr
- ▶ By Mail : A.I.T. France, 117 rue de Stalingrad, 78800 Houilles - France

For credit card payment, please contact us.

Since 1991, A.I.T. France has been an acknowledge chromatography specialist. Our legal and financial independence and our long experience have made us develop our wide range of smart caps :

The Smart Caps' range for more than 10 years, thus ranking us as one of the European leaders in this field, thanks to a workshop with 1000 m² of workshop. Our team is inspired by the will to offer to its clients a flexible and an efficient service with competitive priced products.

A.I.T. France is very attentive to your needs.

Being an authentic manufacturer, we are ready to help you with particular requests and equipment installation in your laboratories, even for one single item without any further cost.

A.I.T. France will always strive to earn your confidence.

Should you want to distribute our products ? Please, contact us, OEM manufacturing are welcome.

Pascal AZNAR

President of A.I.T. France

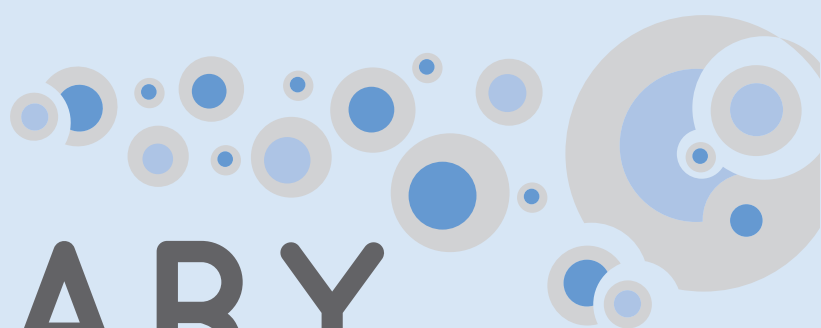

SUMMARY

	HEALTHY AND WASTE CAPS, HOW IT WORKS ?	4-7		
	SMART HEALTHY CAPS			
	ANALYTICAL SYSTEM			
	Guide for installing a SHC	8		
	Smart Healthy Caps GL45	9		
	GL45 thread with stopcock	9-10		
	Ground neck	10		
	Distri Smart	11		
	Smart Healthy Caps with septum	12		
	PREPARATIVE HPLC SYSTEM			
	GL45 thread	13		
	DIN 51/S55 & S60 thread	14		
	Safety funnel for preparative	15		
	ADAPTERS			
	Multi-Ways adapters	16		
	Operating principle	17		
	Classic adapters	18		
	BOTTLE			
	DURAN® glass bottle GL45	19		
	ACCESSORIES			
	Air check valve	20		
	2 in 1 fittings	21		
	Fittings and Ferrules	22		
	Tubing	23		
	SMART WASTE CAPS			
	ACTIVATED CHARCOAL CARTRIDGE			
	Cartridge for Cans	24		
	Cartridge for Metallic barrel	25		
	Adapters	26		
	Adapters for JUSTRITE® can	27		
	SMART WASTE CAPS THREADS			
	Guide for installing a SWC		28	
	DIN 51 / S55		29	
	GL45		30	
	Burkle S50		31	
	DIN 60 / S61		32	
	DIN 90 / S90		33	
	NALGENE® bottle		34	
	Level indicator		35	
	Special demands		36	
	ADAPTERS			
	For cans fitted		37-38	
	ACCESSORIES			
	2 in 1 universal fittings		39	
	Leak tube fittings		40-41	
	Conectors and adapters		42	
	Tubing and blind plugs		43	
	Quick connect fittings		44-45	
	SAFETY FUNNELS			
	Funnel with Hinged lid		48-49	
	Funnel with stopcock		50	
	Funnel with ball valve		39-53	
	Electro conductive funnel		54	
	CANS		56-57	
	Cans		56	
	Retention tray		57	
	Space-saving cans		57	
	INDEX		58-61	

HEALTHY AND WASTE CAPS,

A ONE WAY AIR CHECK VALVE TECHNOLOGY

DANGER !

*Tubes slip out of place
and air is suctioned in, so
the process is interrupted.*

Before

SECURE

*Tubes remain in position,
thanks to a ferrule firmly
tightened into a flanged
fitting. Safe closure, no
toxic vapours.*

After

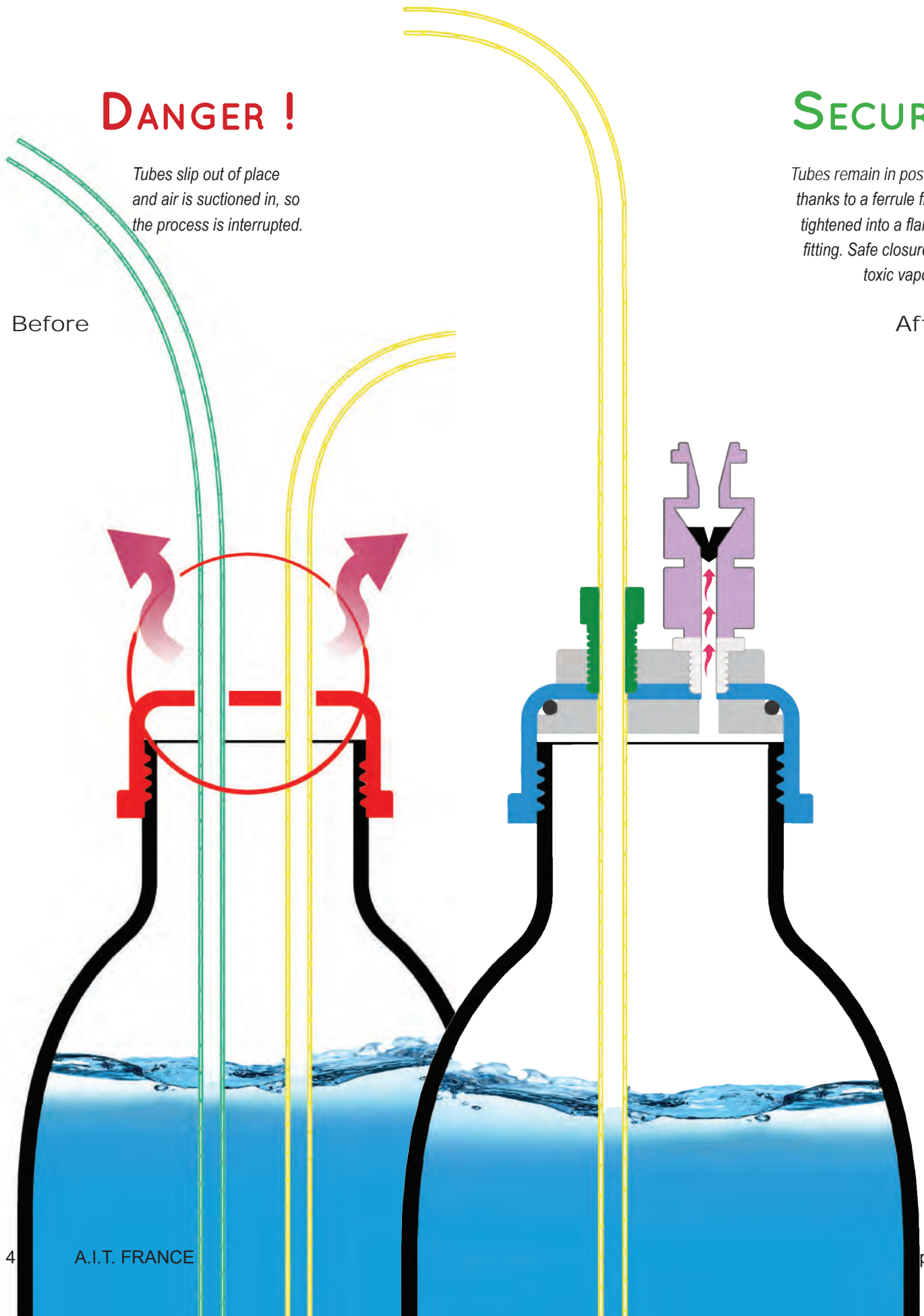

HOW DOES IT WORKS ?

A TECHNOLOGY TO PROTECT YOUR HEALTH

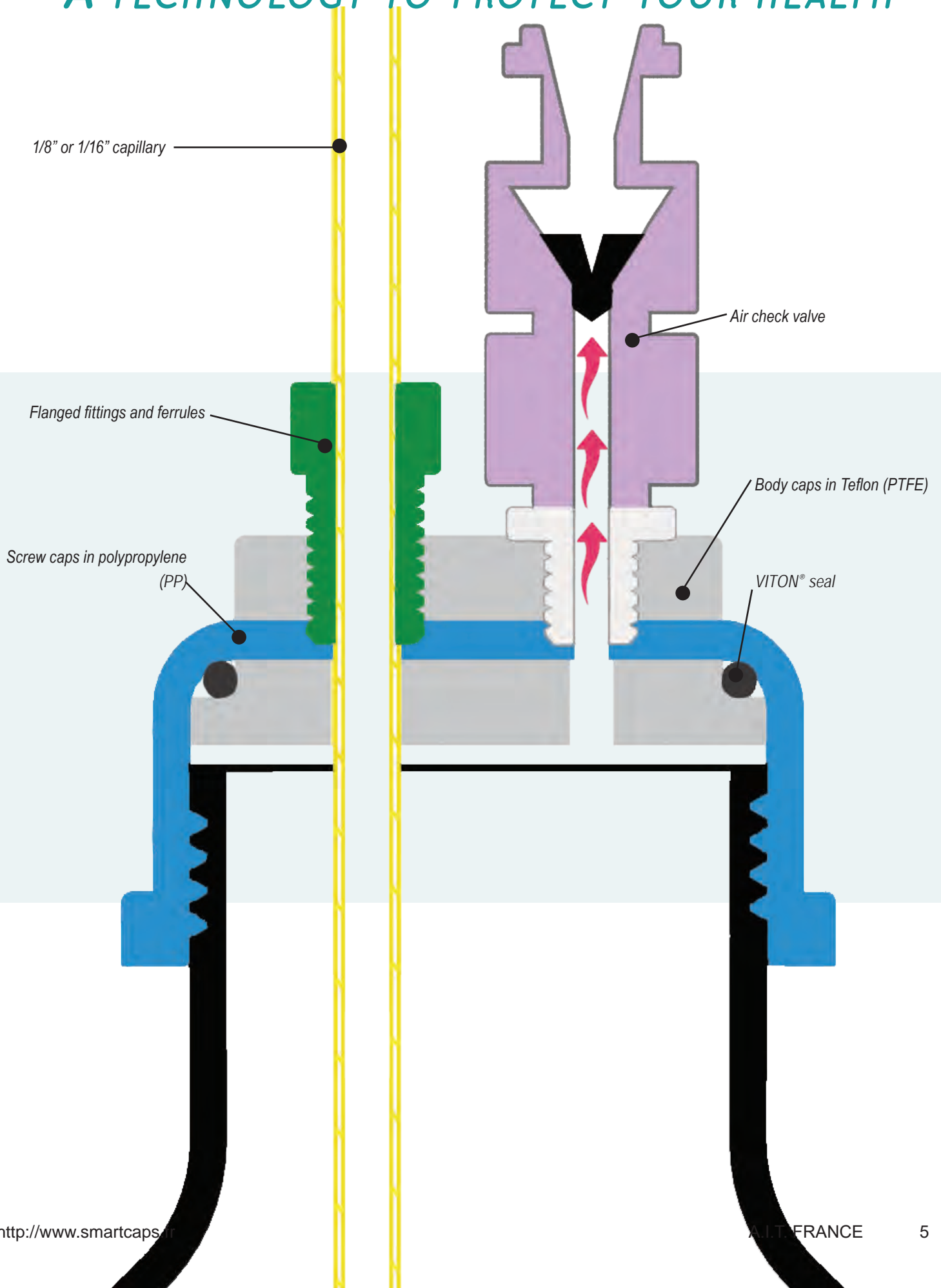

HEALTHY AND WASTE CAPS,

A ONE WAY AIR CHECK VALVE TECHNOLOGY

Smart Healthy Caps are in response to modern laboratory safety regulations.

They are made of inert materials resistant to chemicals.

The use of a one-way air check valve allows for low cost safe and secure solvent extraction in your laboratory.

- ▶ No solvent evaporation. ✓
- ▶ Keep your concentration accurate for several days. ✓
- ▶ No mobile phase external contamination. ✓

360° ROTATION!

The rotation of the central part of the caps allows a good ease of installation, and also avoids any entanglement of tubes.

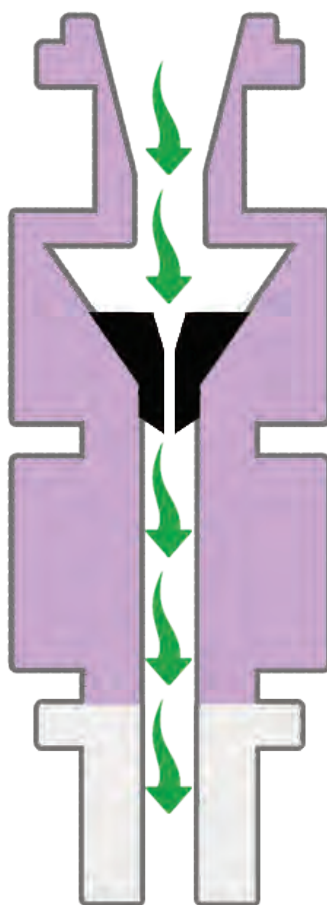

The membrane allows air to enter for pressure equalization.



The membrane is a barrier against eluent vapours and gas leaks.

HOW DOES IT WORKS ?

A TECHNOLOGY TO PROTECT YOUR HEALTH

A Smart Waste Caps is formed by an airtight cap, drilled by a variable number of holes to host effluents tubes outgoing of the HPLC system.

The main piece is a cartridge filled with activated charcoal attached to the cap. This filter allows the absorption of 98% of the solvent's vapours released by the solvent's can.

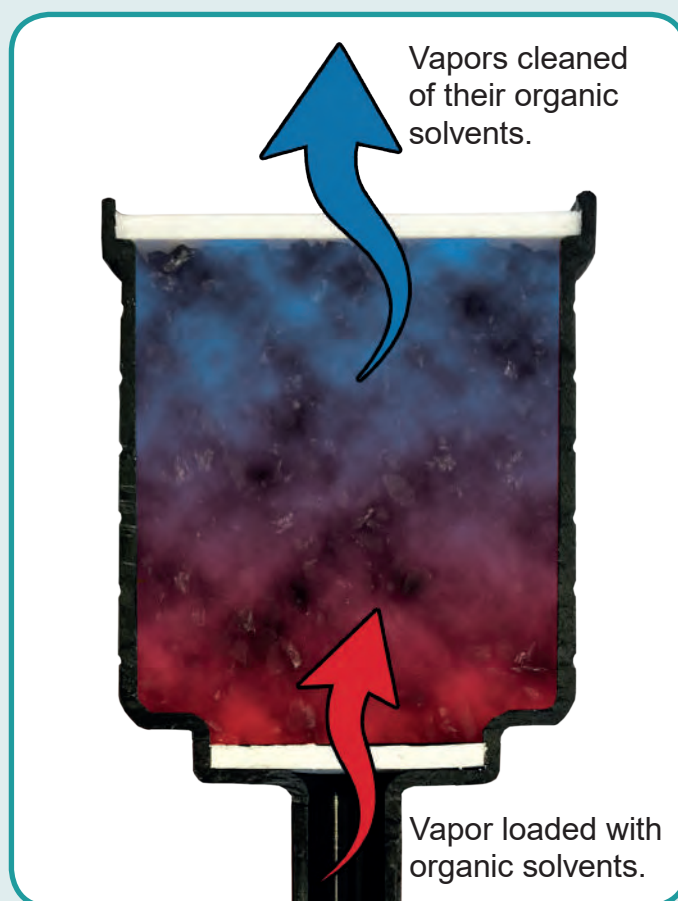

AIT France offers a diversified range of activated charcoal cartridge for the emission of eluent or solvent vapors; by special charcoal impregnation, the cartridges become an excellent barrier against concentrated acids or bases.

SMART HEALTHY CAPS

GUIDE FOR INSTALLING A SMART HEALTHY CAPS

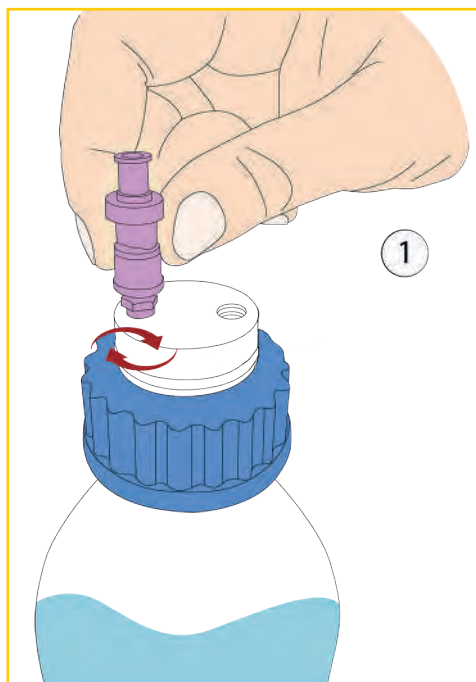

- Our Smart Healthy Caps are delivered with their pre-installed air check valves. However, if you need a valve that is resistant to polar solvent or amine derivatives vapors, simply unscrew the valve in place and then screw the new valve into its proper thread of the cap.

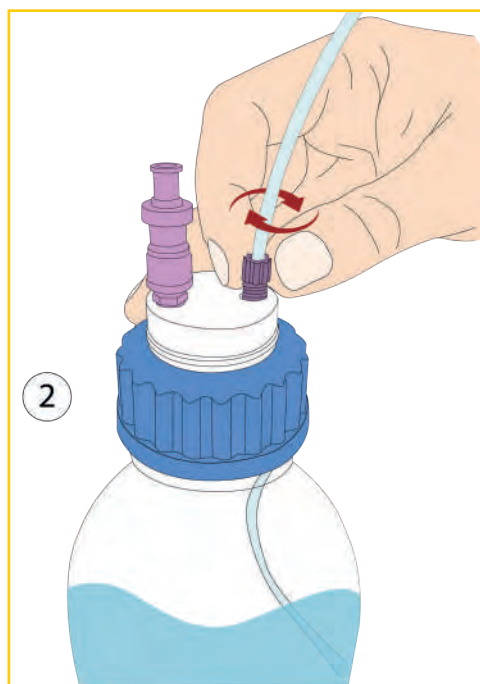

- Screw the 2 in 1 fitting into its proper thread on your Smart Healthy Cap. (See our “Installing a 2-in-1 fitting” guide on page 21 for more details)

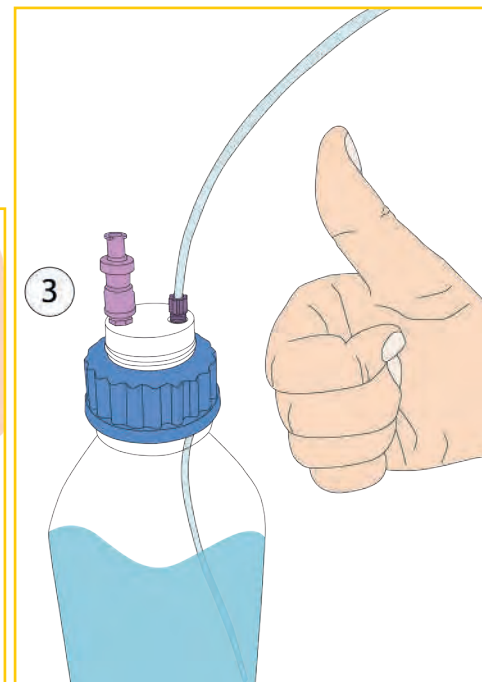

- Installation completed!

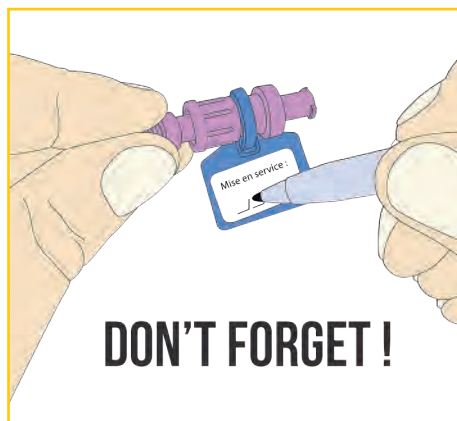

...And do not forget to indicate the date of commissioning of your air check valve in order to be able to anticipate its renewal!

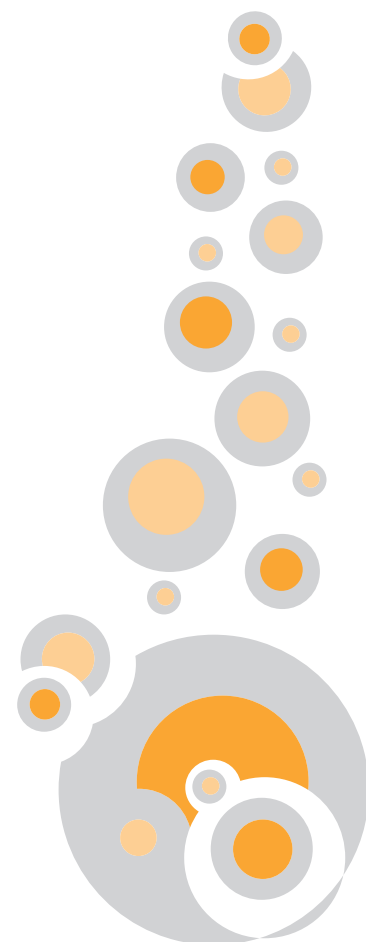

SMART HEALTHY CAPS

ANALYTICAL SYSTEM



GL45 THREAD TYPE WITH AIR CHECK VALVE

Smart Healthy Caps for GL45 or DURAN® types are the most widespread in laboratories. Smart Healthy Caps are delivered with their Universal 2 in 1 capillary fitting (external diameter 1/8" to 1/16").



DESCRIPTION	FERRULE *	REFERENCE
Smart healthy caps GL45, 1 outlet and 1 air check valve	1/8"	SHC-1
Smart healthy caps GL45, 2 outlets and 1 air check valve	1/8"	SHC-2
Smart healthy caps GL45, 3 outlets and 1 air check valve	1/8"	SHC-3
Smart healthy caps GL45, 4 outlets and 1 air check valve	1/8"	SHC-4
Smart healthy caps GL45, 5 outlets and 1 air check valve	1/8"	SHC-5



* For another diameter, precise it when you order it.

Warning : Change your air check valve **once a year**.

GL45 THREAD WITH STOPCOCK.

GL45 Smart Healthy Caps with a stopcock offer more flexibility, without air bubbles inside the tubing. Smart Healthy Caps are delivered with their fittings 1/8" (external diameter 3,2 mm).



SMART HEALTHY CAPS



SHC-V2



SHC-V4

DESCRIPTION	FERRULE *	REFERENCE
Smart healthy caps GL45, 1 outlet with shut-off and 1 air check valve	1/8"	SHC-V1
Smart healthy caps GL45, 2 outlets with shut-off and 1 air check valve	1/8"	SHC-V2
Smart healthy caps GL45, 3 outlets with shut-off and 1 air check valve	1/8"	SHC-V3
Smart healthy caps GL45, 4 outlets with shut-off and 1 air check valve	1/8"	SHC-V4

*For another diameter, specify it when ordering.

GROUND NECK WITH AIR CHECK VALVE

Smart Healthy Caps with ground neck 29/32 are made for ground-necked flasks. Smart Healthy Caps are delivered with their Universal 2 in 1 capillary fitting (external diameter 1/8" to 1/16").



SHC-1-EM



SHC-2-EM



AD-45-EM



DESCRIPTION	FERRULE *	REFERENCE
Smart healthy caps, ground neck (29/32 mm)	1 outlet (1/8"), 1 air check valve	SHC-1-EM
Smart healthy caps, ground neck (29/32 mm)	2 outlets (1/8"), 1 air check valve	SHC-2-EM
Smart healthy caps, ground neck (29/32 mm)	3 outlets (1/8"), 1 air check valve	SHC-3-EM
Smart healthy caps, ground neck (29/32 mm)	4 outlets (1/8"), 1 air check valve	SHC-4-EM

* For another diameter, precise it when you order it.

SMART HEALTHY CAPS

ANALYTICAL SYSTEM

DISTRI SMART SAFE WITH A SMART HEALTHY CAP

DESCRIPTION	REFERENCE
Distri Smart Safe Adapter of 1 outlet (1/8" or 1/16") + 1 air check valve	SHC-1PV
Distri Smart Safe Adapter of 2 outlets (1/8" or 1/16") + 1 air check valve	SHC-2PV
Distri Smart Safe Adapter of 3 outlets (1/8" or 1/16") + 1 air check valve	SHC-3PV
Distri Smart Safe Adapter of 4 outlets (1/8" or 1/16") + 1 air check valve	SHC-4PV
Pipette 1 to 10 mL *	DIS 10
Pipette 2,5 to 25 mL *	DIS 25

A.I.T. is introducing a new variable volume system for eluent distribution which can be directly attached to your HPLC solvent bottle. It provides with the same benefits as the Smart Healthy Caps but with this additional feature. The neck is compatible with the DURAN® GL45 bottles.



* To obtain the same configuration as the picture above, choose a Distri Smart Safe Adapter and a pipette.

SMART HEALTHY CAPS

ANALYTICAL SYSTEM

Smart Healthy Caps Septum offers you the possibility to introduce or withdraw a volume of solvent or reagent of your choice at any time.



DESCRIPTION

REFERENCE

Smart Healthy Caps GL45 1 septum*, 1 outlet (1/8" or 1/16") and 1 air check valve	SHC-1-SEPT
Smart Healthy Caps GL45 1 septum*, 2 outlets (1/8" or 1/16") and 1 air check valve	SHC-2-SEPT
Smart Healthy Caps GL45 1 septum*, 3 outlets (1/8" or 1/16") and 1 air check valve	SHC-3-SEPT

SHC-2-SEPT

*The septum is delivered as standard, non-pierced



SMART HEALTHY CAPS

PREPARATIVE SYSTEM

SMART HEALTHY CAPS FOR GL45 SCHOTT®
OR DURAN® TYPE

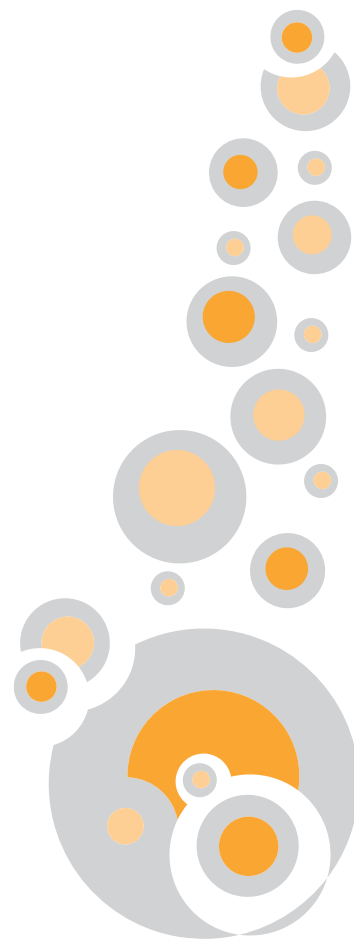

 Warning : **Change your air check valve once a year.**

DESCRIPTION	REFERENCE
Smart Healthy Caps GL45 for preparative HPLC with 1 outlet (1/4") + 1 air check valve	SHC-P-A
Smart Healthy Caps GL45 for preparative HPLC with 2 outlets (1/4" and 1/8") + 1 air check valve	SHC-P-A-C
Smart Healthy Caps GL45 for preparative HPLC with 1 outlet (3/16") + 1 air check valve	SHC-P-B
Smart Healthy Caps GL45 for preparative HPLC with 2 outlets (3/16") + 1 air check valve	SHC-P-2B



SHC-P-A-C



SHC-P-A



SHC-P-B

**OTHER
CONFIGURATIONS
POSSIBLE ON
REQUEST!**

SMART HEALTHY CAPS

PREPARATIVE SYSTEM

SMART HEALTHY CAPS FOR DIN51/S55 AND DIN60/S60 THREADS

Specially adapted for large volumes of preparative HPLC eluents. The air check valve works with a flow rate from 150ml / min to 500ml / min.



DESCRIPTION *	REFERENCE
Smart Healthy Caps S55 for preparative HPLC with 1 outlet (1/4") + 1 air check valve	SHC55-P-A
Smart Healthy Caps S55 for preparative HPLC with 2 outlets (1/4" et 1/8") + 1 air check valve	SHC55-P-A-C
Smart Healthy Caps S55 for preparative HPLC with 1 outlet (3/16") + 1 air check valve	SHC55-P-B
Smart Healthy Caps S60 for preparative HPLC with 1 outlet (1/4") + 1 air check valve	SHC60-P-A
Smart Healthy Caps S60 for preparative HPLC with 2 outlets (1/4" et 1/8") + 1 air check valve	SHC60-P-A-C
Smart Healthy Caps S60 for preparative HPLC with 1 outlet (3/16") + 1 air check valve	SHC60-P-B



*also available with any type of thread (Nalgene, DIN90...)

Create your own reference !

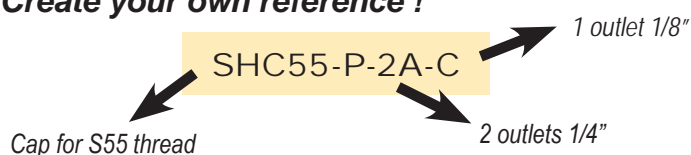

Oulets : A = 1/4", B = 3/16", C = 1/8"

SMART HEALTHY CAPS

PREPARATIVE SYSTEM

SMART HEALTHY CAPS WITH FUNNEL FOR PREPARATIVE HPLC BOTTLE

This Smart Healthy Caps, equipped with a funnel with hinged lid, allows to pour the eluent into the bottle without having to unscrew the cap. It is equipped with an air check valve.

SHC45-FSP-B



DESCRIPTION

THREAD

REFERENCE

Funnel with hinged lid for solvent reservoir with one outlet of 4 mm (3/16") and one air check valve

GL45

SHC45-FSP-B

S55

SHC55-FSP-B

S60

SHC60-FSP-B

NALGENE® B53

SHCB53-FSP-B

Metallic barrel

SHCBA-FSP-B

Funnel with hinged lid for solvent reservoir with one outlet of 6.4 mm (1/4") and one air check valve

GL45

SHC45-FSP-A

S55

SHC55-FSP-A

S60

SHC60-FSP-A

NALGENE® B53

SHCB53-FSP-A

Metallic barrel

SHCBA-FSP-A

Funnel with hinged lid for solvent reservoir with one outlet of 3.2 mm (1/8") and one air check valve

GL45

SHC45-FSP-C

S55

SHC55-FSP-C

S60

SHC60-FSP-C

NALGENE® B53

SHCB53-FSP-C

Metallic barrel

SHCBA-FSP-C

Create your own reference !

SHC55 - FSP - B

Thread type

Tube outer diameter

Oulets : A = 1/4", B = 3/16", C = 1/8"

SMART HEALTHY CAPS

ADAPTERS WITH MULTIPLE WAYS

MULTI-WAYS ADAPTER ALLOWING TO CONNECT A BOTTLE WITH A GL45 THREAD TO 2 & 4 GL45 SAFETY CAPS*

The multi-ways adapter allows several channels to be purged in the eluent bottle while remaining airtight.

BEFORE...

AFTER!

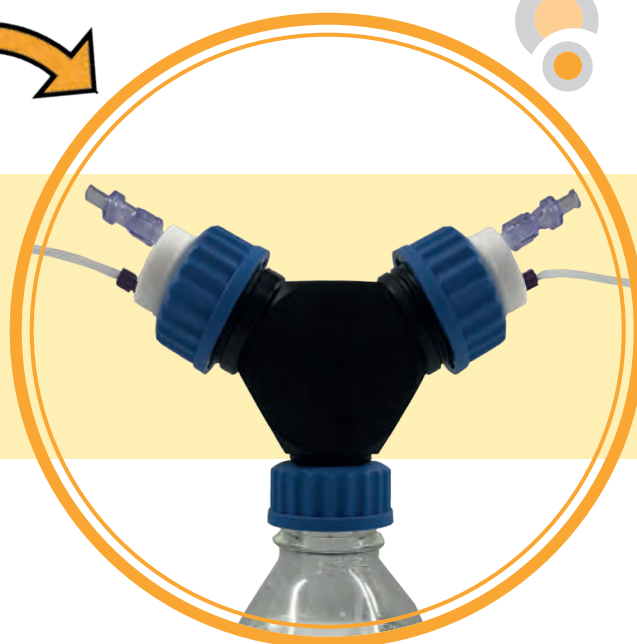

AD-2T-GL45
for 2 SHC



AD-4T-GL45
for 4 SHC

* Also available for other threads of bottles and cans

SMART HEALTHY CAPS

ADAPTERS

OPERATING PRINCIPLE

We can supply you with all types of adapters not described in the catalog.
Do not hesitate to ask us!



32 mm

GL32 bottle
Measures 32 mm for
external threads.

Smart Healthy Caps GL45



38 mm

GL38 bottle
Measures 38 mm for
external threads.

Adapter

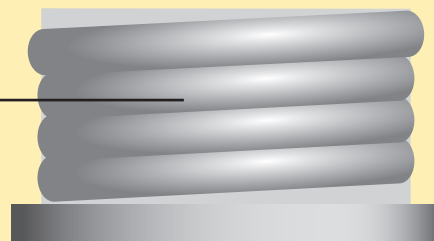

45 mm

GL45 bottle
Measures 45 mm for
external threads.

Thread

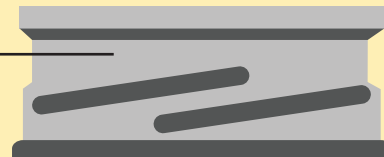

SMART HEALTHY CAPS

CLASSIC ADAPTERS

To connect a GL45 cap on a bottle with a different thread.

THREAD*	To**	MATERIAL	REFERENCE
GL40	GL45	PTFE	AD-40-45-T
GL40	GL45	PP	AD-40-45-P
GL32	GL45	PTFE	AD-32-45-T
GL32	GL45	PP	AD-32-45-P
GL38	GL45	PTFE	AD-38-45-T
GL38	GL45	PP	AD-38-45-P



AD-40-38-P



AD-38-45-T



AD-40-45-P

PTFE : Teflon.

PP : Polypropylene.

* Bottle thread

** Cap's Thread : Smart Healthy Caps.

NOTES

.....

.....

.....

.....

.....

.....

SMART HEALTHY CAPS

BOTTLE

DURAN® GL45 BOTTLE

A complete range of solvent bottles perfectly adapted for GL45 Smart Healthy Caps.

GL250-C



GL2000-C



VOLUME (mL)	GLASS	REFERENCE
-------------	-------	-----------

250	Clear	GL250-C
-----	-------	---------

250	Amber	GL250-A
-----	-------	---------

500	Clear	GL500-C
-----	-------	---------

500	Amber	GL500-A
-----	-------	---------

1000	Clear	GL1000-C
------	-------	----------

1000	Amber	GL1000-A
------	-------	----------

2000	Clear	GL2000-C
------	-------	----------

2000	Amber	GL2000-A
------	-------	----------

5000	Clear	GL5000-C
------	-------	----------

5000	Amber	GL5000-A
------	-------	----------

GL1000-C



GL500-C



SMART HEALTHY CAPS

ACCESSORIES : AIR CHECK VALVE

All our Smart Healthy Caps are equipped with a standard air check valve.

For optimal use, it is recommended to **change the air check valve once a year!**

STANDARD AIR CHECK VALVE

For organo-aqueous eluents.

Weak and strong acidic eluents.

Non-amino basic eluents.

Polar & apolar eluents.

Maximum recommended flow: 100mL / min

REFERENCE	QTY
SHC-SV	1
SHC-SV10	10
SHC-SV50	50

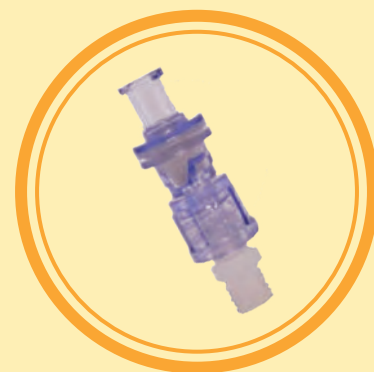

SHC-SV-PREP

AIR CHECK VALVE FOR PREPARATIVE HPLC

Same characteristics as the standard air check valve but for HPLC systems with very high flow rates (>100mL / min and <500mL / min).

AIR CHECK VALVE FOR BASIC AMINE SOLVENTS

Same characteristics as the standard air check valve, but essential for the use of eluents containing bases with high pKa (triethylamine) or high concentrations (ammonia).

REFERENCE	QTY
SHC-SV-AB	1
SHC-SV-AB10	10
SHC-SV-AB50	50



SMART HEALTHY CAPS

ACCESSORIES : THE 2 IN 1 UNIVERSAL FITTING

- Facilitates the connection of capillary tubes from 1 mm to 3,2 mm (1/8")
- The 2 in 1 Universal fitting replaces the entire fitting + ferrule 1/8" and 1/16"
- The 2 in 1 Universal fitting ensures excellent sealing

GUIDE FOR 2 IN 1 FITTING CHANGE:

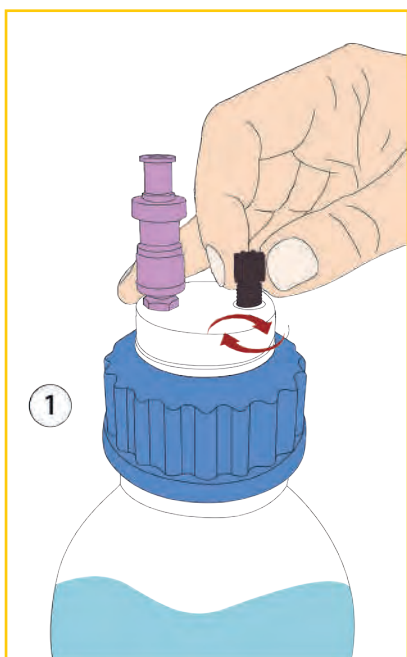

- Insert the 2 in 1 fitting into its proper thread, without fully tightening it.

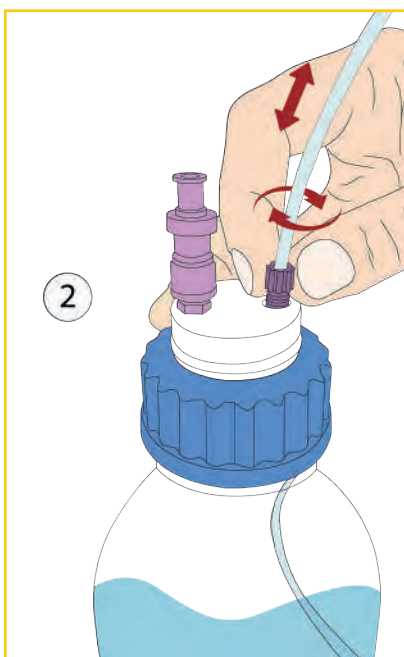

- Insert your tube into the 2 in 1 fitting, adjust its length and then screw the fitting until the tube stops moving.

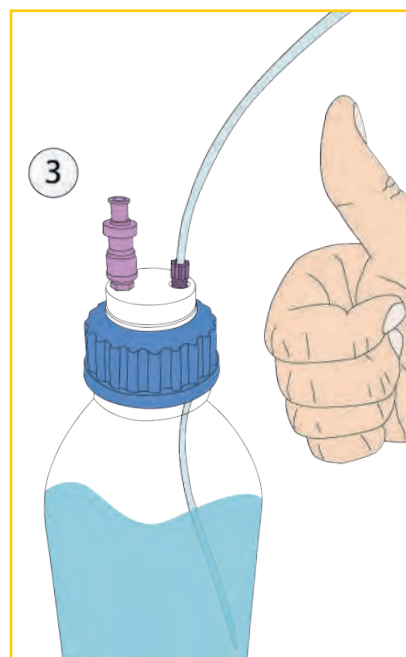

- Installation completed!



DESCRIPTION	FOR TUBE (OD)	COLOR	QTY/PK	REFERENCE
2 in 1 Fitting, Type I Black	for 1/16" to 1mm	Black	5	CC-ONE-1BL
2 in 1 Fitting, Type I Purple	for 1/16" to 1mm	Purple	5	CC-ONE-1V
2 in 1 Fitting, Type II Black	for 1/8" to 1/16"	Black	5	CC-ONE-2BL
2 in 1 Fitting, Type II Purple	for 1/8" to 1/16"	Purple	5	CC-ONE-2V



SMART HEALTHY CAPS



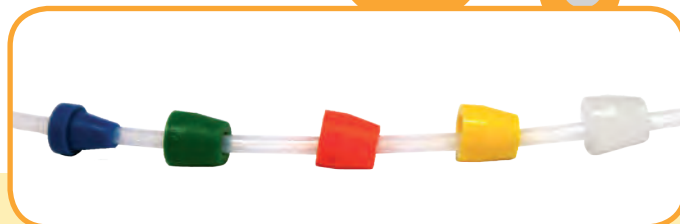

ACCESSORIES

NUTS AND FERRULES FOR 1/8" AND 1/16"

Ferrules 1/8", ref : F18. Flangefree fitting for ferrule 1/8" OD.
 Ferrules 1/16", ref : F16. Flangefree fitting for ferrule 1/16" OD.



* Please join to the reference the color you want.
 For example : R18-N for black nuts.

Red : R 
 Blue: B 
 Green: G 
 Purple: P 
 Black: N 

TUBE (OD)		REFERENCE NUTS	REFERENCE FERRULES
INCH	MILLIMETER	PER 10 UNITS *	PER 10 UNITS
1/4"	6,3 mm	R14	F14
3/16"	4 mm	R316	F316
1/8"	3,2 mm	R18	F18
	2,5 mm	R18	F25
1/16"	1,6 mm	R16	F16
	1,0 mm	R16	F10

BLIND PLUG, ALLOWING YOU TO CLOSE AN UNUSED OUTLET OF YOUR SMART HEALTHY CAPS

FOR	REFERENCE	QUANTITY
Vis 1/8"	VP-F18	Par 10

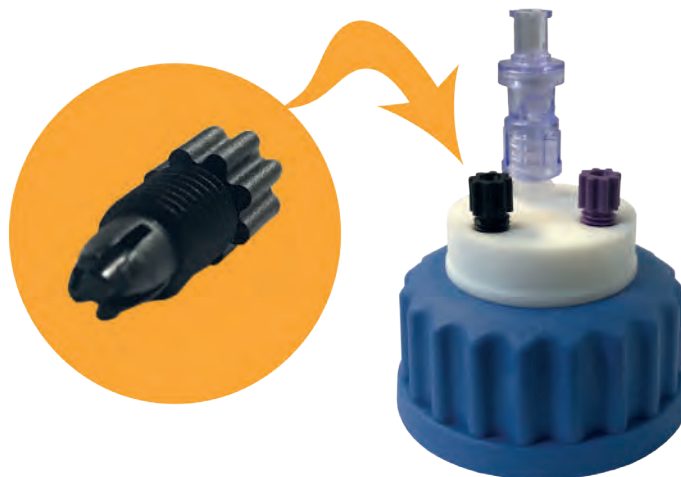

SMART HEALTHY CAPS

PTFE TUBES

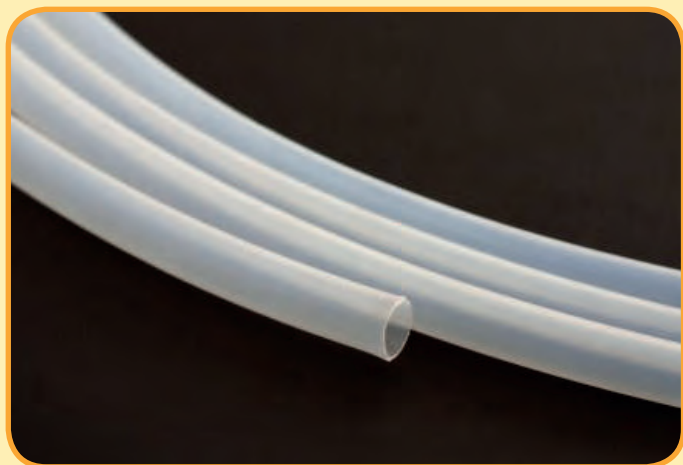

OD	ID	REFERENCE *	QUANTITY
1/4"	6,3 mm	TP14	1 mètre
3/16"	3 mm	TP316	1 mètre
1/8"	1,6 mm	TP18	1 mètre
1/16"	1,0 mm	TP16	1 mètre

TYGON™ TUBES



OD	ID	REFERENCE *	QUANTITY
9,5 mm	6,4 mm	TYG-64	1 mètre
19,1 mm	12,7 mm	TYG-127	1 mètre

NOTES

.....

.....

.....

.....

.....

.....

.....

.....

SMART WASTE CAPS

ACTIVATED CHARCOAL CARTRIDGE

ACTIVATED CHARCOAL CARTRIDGE FOR CANS FROM 2,5 TO 20 LITERS



Each cartridge is delivered with a label on which you can write the commissioning date and the replacement date of your cartridge.

The replacement date depends on the quantity of activated charcoal in the cartridge.

* For each charcoal filter cartridge order, a time monitoring is delivered if you ask for. Just add the letter T at the end of the reference.

DESCRIPTION	QUANTITY OF CHARCOAL	DURATION	REFERENCE
Activated charcoal cartridge	25 gr	3 months	FC-25
Activated charcoal cartridge	50 gr	6 months	FC-50
Activated charcoal cartridge with a lid	50 gr	6 months	FC-50-C
Activated charcoal cartridge	100 gr	12 months	FC-100
Activated charcoal cartridge loaded with H₂SO₄ for volatile base in waste eluants.	100 gr*	6 months	FC-100-H2SO4
Activated charcoal cartridge loaded with KOH for volatile acid in waste eluants.	100 gr*	6 months	FC-100-KOH

SMART WASTE CAPS

CARTRIDGE OF ACTIVATED CHARCOAL FOR METALLIC BARREL FROM 50 TO 200 LITERS

For a metallic barrel, a higher quantity of activated charcoal is needed. We propose you 2 models of filter depending on the volume of your metallic barrel.

DESCRIPTION	FOR A METALLIC BARREL OF	THREAD	REFERENCE
Activated charcoal cartridge of 250 gr	50 L	2" Mautser	FC-250
Activated charcoal cartridge of 500 gr	200 L	2" Mautser	FC-500

A wide range of safety funnels is proposed to you page 46 to 55.



SMART WASTE CAPS

ACTIVATED CHARCOAL CARTRIDGE

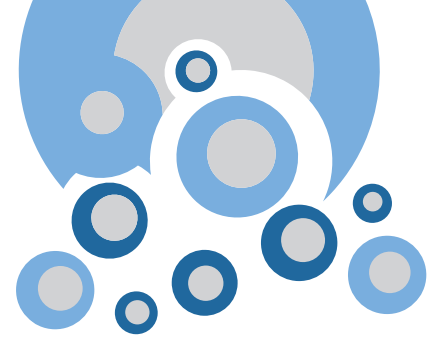

ADAPTERS FOR ACTIVATED CHARCOAL CARTRIDGE

If you have a problem to place the can with the cartridge under the bench, we offer you 4 types of adapters which can be combined to solve all of you problems. You can see below few types of combinations. Other combinations are possible.

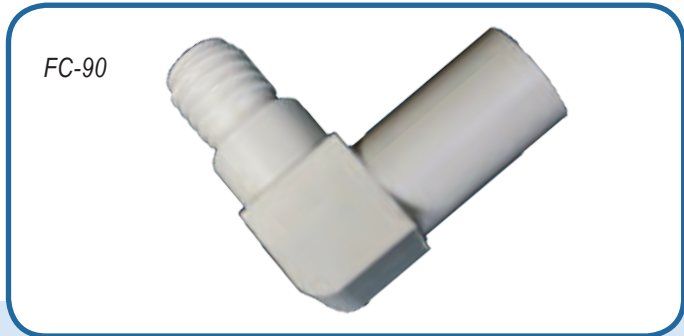
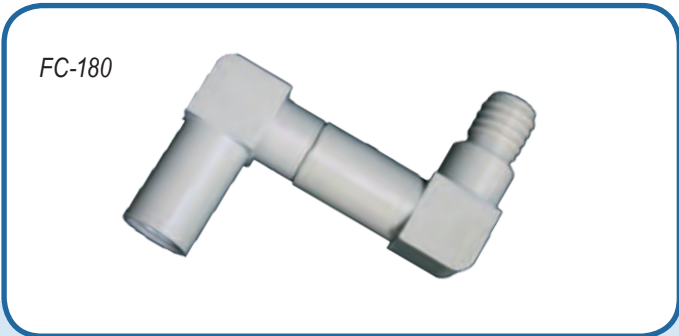
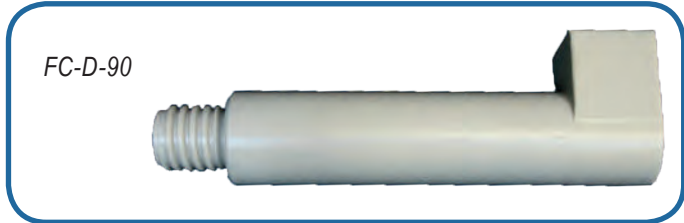
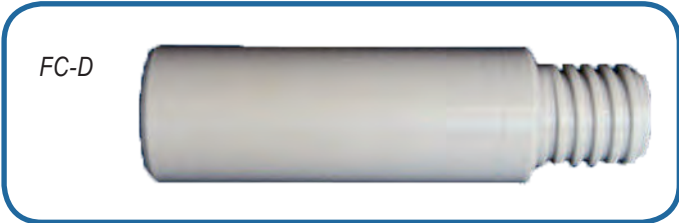

DESCRIPTION	REFERENCE
Straight extension long piece	FC-D
90° Adapter for angled connection	FC-90
Double angled connection adapter (combination of 2 FC-90)	FC-180
Straight extension long piece with 90° adapter for angled connection	FC-D-90



SMART WASTE CAPS

SPECIAL ADAPTERS* FOR JUSTRITE® CAN

* Allows to accept activated charcoal cartridge on JUSTRITE® can.



DESCRIPTION	REFERENCE
Adapter with 3 entries and a tube fitting for a direct CPC connection	AD-CPC
Adapter with 3 entries and a tube fitting for a connection on JUSTRITE® can	AD-D-JUST
Adapter with an activated charcoal cartridge location for JUSTRITE® container	FC-AD-JUST
Adapter with an activated charcoal cartridge location for CPC connection	FC-AD-CPC

SMART WASTE CAPS

GUIDE FOR INSTALLING A SMART WASTE CAPS

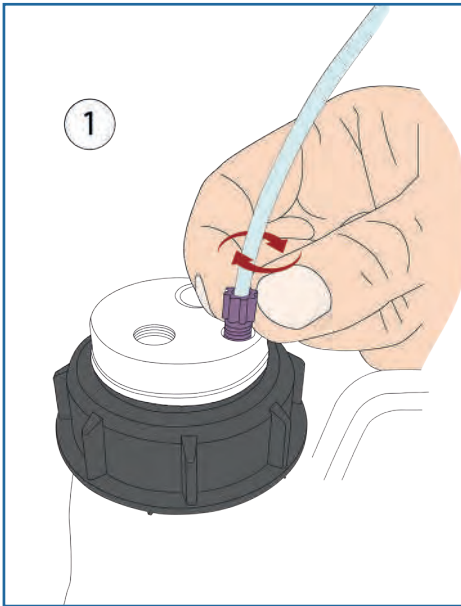

- Insert the 2 in 1 fitting into its proper thread

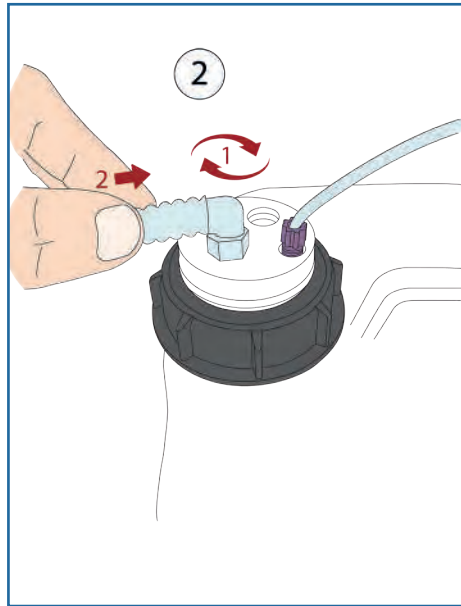

- Screw the Leak fitting into its proper thread on your Smart Waste Cap. Connect your tube to the Leak fitting

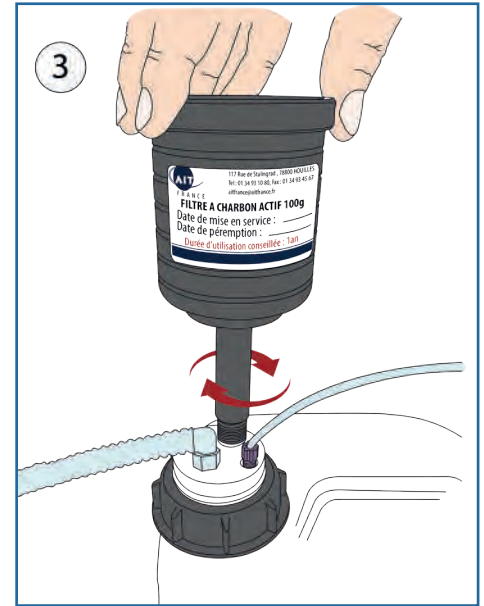

- Screw your activated charcoal cartridge into its proper thread on your Smart Waste Caps

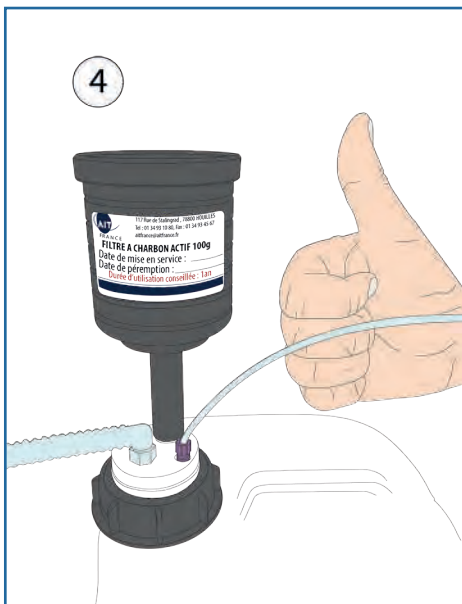

- Installation completed!



And do not forget to indicate the date of commissioning and the expiration date of your activated charcoal cartridge to anticipate its renewal!

SMART WASTE CAPS

SMART WASTE CAPS FOR DIN 51 / S55

AIT Smart Waste Caps for DIN 51/S55 with their Universal 2 in 1 capillary fitting (external diameter 1/8" to 1/16") and tube fitting 6 to 9 mm.



SW55-4-C : 4 entries 1/8" and charcoal cartridge emplacement



SW55-2-C-1L : 2 entries 1/8", 2 tube fittings and charcoal cartridge emplacement



SW55-1-C-3L : 1 entry 1/8", 3 tube fittings and charcoal cartridge emplacement

If you can't find the reference you want, then, create your own Smart Waste Cap even just for one item, without further cost.

Create your own reference !

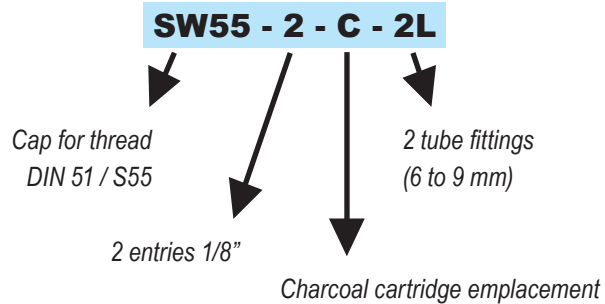

SW55-4-C-1L : 4 entries 1/8", a charcoal cartridge emplacement and 1 tube fitting



SW55-5-C : 5 entries 1/8" and a charcoal cartridge emplacement



SW55-3-C-2L : 3 entries 1/8", a charcoal cartridge emplacement and 2 tube fittings



SW55-3-C-3L : 3 entries 1/8", a charcoal cartridge emplacement and 3 tube fittings

SMART WASTE CAPS

SMART WASTE CAPS THREADS

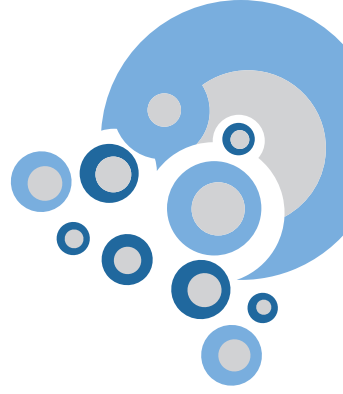

SMART WASTE CAPS FOR GL45

AIT Smart Waste Caps for GL45 with their Universal 2 in 1 capillary fitting (outer diameter 1/8" to 1/16") and tube fitting.



SW45-2-C : 2 entries 1/8" and charcoal cartridge emplacement



SW45-5-C : 5 entries 1/8" and charcoal cartridge emplacement



SW45-4-C-1L : 4 entries 1/8", 1 tube fitting and charcoal cartridge emplacement



SW45-1-C-2L : 1 entry 1/8", 2 tube fittings and charcoal cartridge emplacement

If you can't find the reference you want, then, create your own Smart Waste cap even just for one item, without further cost.

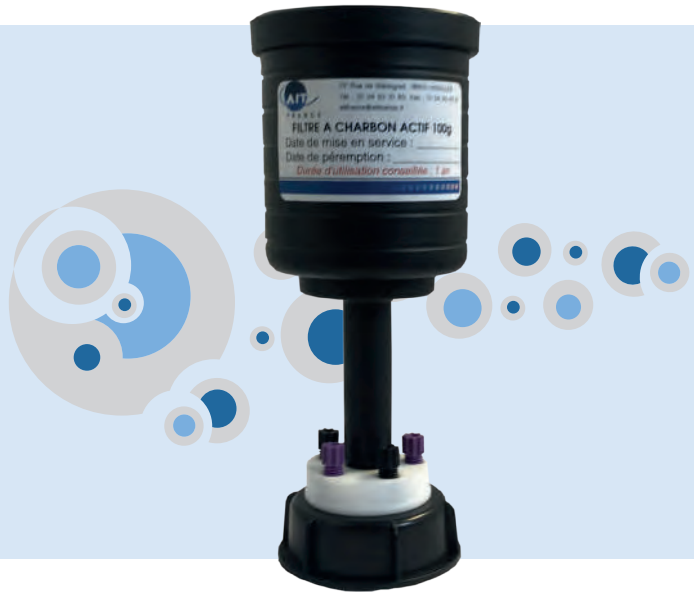
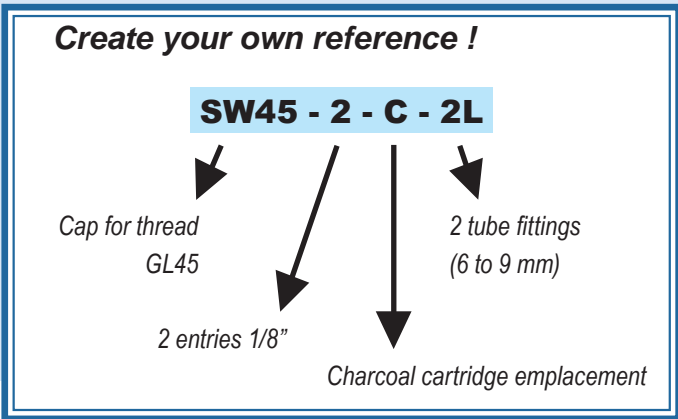

SW45-C-2L : a charcoal cartridge emplacement and 2 tube fittings



SW45-1-C-1L : 1 entry 1/8", a charcoal cartridge emplacement and 1 tube fitting



SW45-2-C-2L : 2 entries 1/8", a charcoal cartridge emplacement and 2 tube fittings



SW45-C-3L : a charcoal cartridge emplacement and 3 tube fittings

SMART WASTE CAPS

SMART WASTE CAPS THREADS

SMART WASTE CAPS BURKLE AND DIN50

Smart Waste Caps for space-saving cans S50 equipped with their Universal 2 in 1 capillary fitting (outer diameter 1/8" to 1/16") and tube fitting 6 to 9 mm.



SWB-1-C-1L : 1 entry 1/8", 1 tube fitting and charcoal cartridge emplacement



SWB-3-C : 3 entries 1/8" and charcoal cartridge emplacement



SWB-1-C-3L : 1 entry 1/8", 3 tube fittings and charcoal cartridge emplacement



SWB-5-C-1L : 5 entries 1/8", 1 tube fitting and charcoal cartridge emplacement

If you can't find the reference you want, then, create your own Smart Waste cap even just for one item, without further cost.

Create your own reference !

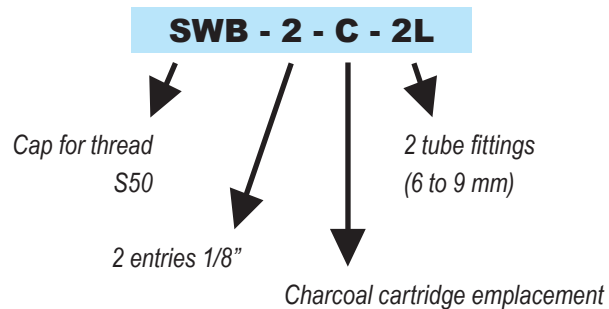

SWB-5-C : 5 entries 1/8" and charcoal cartridge emplacement



SWB-2-C-1L : 2 entries 1/8", 1 tube fitting and charcoal cartridge emplacement



Space saving can (5 Liters)
Ref : BS-GP

SMART WASTE CAPS

SMART WASTE CAPS THREADS

SMART WASTE CAPS FOR DIN 60 / S61

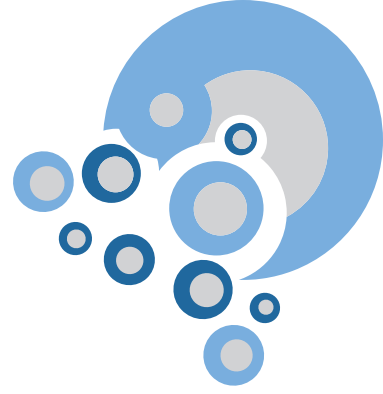

AIT Smart Waste Caps for DIN 60/S61 with their Universal 2 in 1 capillary fitting (outer diameter 1/8" to 1/16") and tube fitting 6 to 9 mm.



SW60-2-C : 2 entries 1/8" and charcoal cartridge emplacement



SW60-2-C-1L : 2 entries 1/8", 1 tube fitting and charcoal cartridge emplacement



SW60-5-C-1L : 5 entries 1/8", 1 tube fitting and charcoal cartridge emplacement



SW60-1-C-4L : 1 entry 1/8", 4 tube fittings and charcoal cartridge emplacement

If you can't find the reference you want, then, create your own Smart Waste cap even just for one item, without further cost.

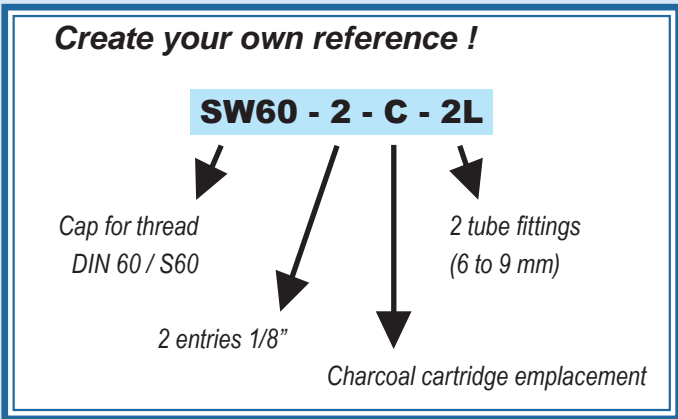

SW60-1-C-1L : 1 entry 1/8", a charcoal cartridge emplacement and 1 tube fitting



SW60-6-C : 6 entries 1/8" and a charcoal cartridge emplacement



SW60-2-C-4L : 2 entries 1/8", a charcoal cartridge emplacement and 4 tube fittings



SW60-C-1L : a charcoal cartridge emplacement and 1 tube fitting

SMART WASTE CAPS

SMART WASTE CAPS THREADS

SMART WASTE CAPS FOR DIN 90 / S90

AIT Smart Waste Caps for DIN 90/S90 with their Universal 2 in 1 capillary fitting (outer diameter 1/8" to 1/16") and tube fitting 6 to 9 mm.



SW90-3-C : 3 entries 1/8" and charcoal cartridge emplacement



SW90-3-C-1L : 3 entries 1/8", 1 tube fitting and charcoal cartridge emplacement



SW90-3-C-2L : 3 entries 1/8", 2 tube fittings and charcoal cartridge emplacement



SW90-4-C-1L : 4 entries 1/8", 1 tube fitting and charcoal cartridge emplacement

If you can't find the reference you want, then, create your own Smart Waste cap even just for one item, without further cost.

Create your own reference !

SW90 - 2 - C - 2L

Cap for thread
DIN 90 / S90

2 entries 1/8"

Charcoal cartridge emplacement

2 tube fittings
(6 to 9 mm)



SW90-4-C : 4 entries 1/8" and a charcoal cartridge emplacement



SW90-2-C : 2 entries 1/8" and a charcoal cartridge emplacement



SW90-2-C-1L : 2 entries 1/8", a charcoal cartridge emplacement and 1 tube fitting



SW90-2-C-2L : 2 entries 1/8", a charcoal cartridge emplacement and 2 tube fittings

SMART WASTE CAPS

SMART WASTE CAPS THREADS

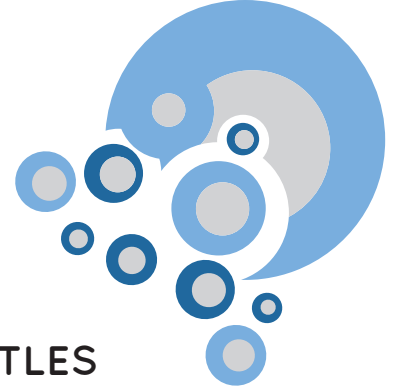

SMART WASTE CAPS FOR NALGENE'S® BOTTLES

AIT Smart Waste Caps for NALGENE's® bottles with their Universal 2 in 1 capillary fitting (outer diameter 1/8" to 1/16") and tube fitting 6 to 9 mm.



SWB83-C-1L

THREAD REFERENCE

B53	SWB53-C-1L
B83	SWB83-C-1L



SWB83-C-3L

THREAD REFERENCE

B53	SWB53-C-3L
B83	SWB83-C-3L

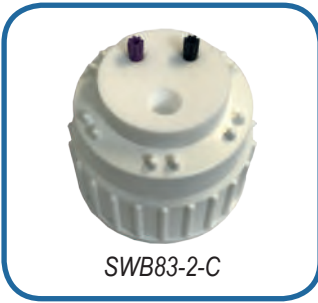

SWB83-2-C

THREAD REFERENCE

B53	SWB53-2-C
B83	SWB83-2-C



SWB83-4-C-1L

THREAD REFERENCE

B53	SWB53-4-C-1L
B83	SWB83-4-C-1L



If you can't find the reference you want, then, create your own Smart Waste Cap even just for one item, without further cost.

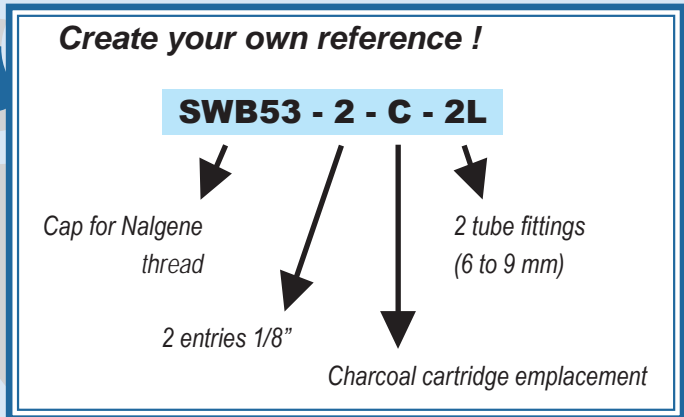

SMART WASTE CAPS

SMART WASTE CAPS THREADS

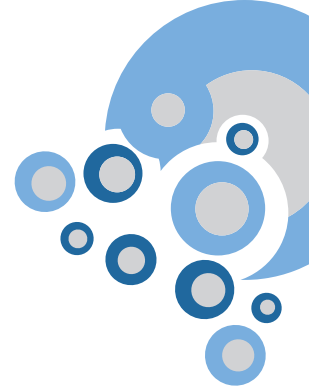

LEVEL INDICATOR

Thanks to the level indicator and its integrated floater, you can check immediately the can level.

The level indicator is absolutely necessary for all the opaque cans and the metallic barrel. We can also equipped the level indicator with fittings 1/8" or 1/16" and tube fitting 6 to 9 mm.

How it works ?

The level indicator is an option. So you can add it to the Smart Waste Caps reference that you want to equip.

For example, you want to equip the Smart Waste Cap following : SW45-2-C-1L with a level indicator. It becomes :

SW45-2-C-1L-LI

Please do not hesitate to contact us with any questions you may have.

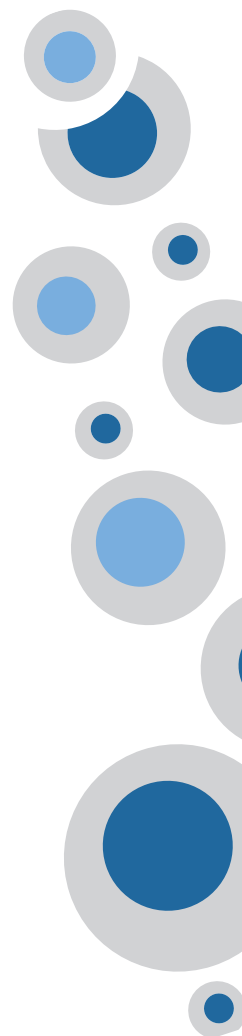

SMART WASTE CAPS

SPECIAL DEMANDS

These 2 elements are easily fixed via their screw system and can go through the bench or be at the edge of the bench.

AD45-PAIL-1L



Thickness of your bench (adjustable)

Through-hole adapter for SW45 caps with 1 outlet for tube fitting (6 to 9mm in standard)

Thickness of your bench (adjustable)



MULTI-MOL-6-4L

Multi-inlet system, 6 1/8" entries and 4 entries for tubes, with an outlet to a can under the bench (11 to 13mm in standard)



SPECIAL MANUFACTURING AT THE REQUEST OF ANY CAP OR ACCESSORY ACCORDING TO YOUR OWN SPECIFICATIONS: FROM A SINGLE PIECE TO MORE THAN A HUNDRED!

SMART WASTE CAPS

ADAPTERS

ALL TYPES OF ADAPTERS ARE POSSIBLE.

UNLIMITED COMBINATIONS! (AS FAR AS POSSIBLE)



45 mm

GL45 bottle
Measures 45 mm for external thread.



48 mm

S55 can
Measures 48 mm for external thread.



53 mm

S60 can
Measures 53 mm for external thread.



SW45-C-1L

Adapter

Thread

SMART WASTE CAPS

ADAPTERS

PP OR PTFE ADAPTERS FOR CANS EQUIPPED WITH A SMART WASTE CAPS

* PP : Polypropylene.

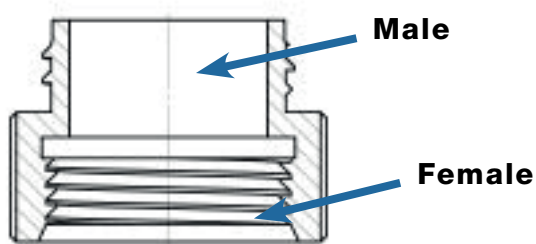

Create your own adapter!

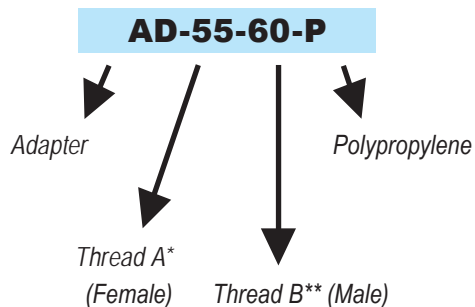

*A = can thread

**B = Smart Waste Caps thread

THREAD A* (FEMALE)	THREAD B** (MALE)	REFERENCE***
GL45	GL32	AD-45-32-P
GL40	GL32	AD-40-32-P
GL45	GL38	AD-45-38-P
GL40	GL38	AD-40-38-P
GL40	GL45	AD-40-45-P
GL45	S55	AD-45-55-P
S55	S60	AD-55-60-P
S55	S90	AD-55-90-P
S60	S90	AD-60-90-P

***also available in Teflon: for this, replace "P" with "T" in the reference of the desired product

SMART WASTE CAPS

ACCESSORIES : 2 IN 1 UNIVERSAL FITTING

- Facilitates the connection of capillary tubes from 1 mm to 3,2 mm (1/8")
- The 2 in 1 Universal fitting replaces the entire nut + ferrule 1/8" et 1/16"
- The 2 in 1 Universal fitting ensures excellent sealing

GUIDE TO CHANGE A 2 IN 1 FITTING :

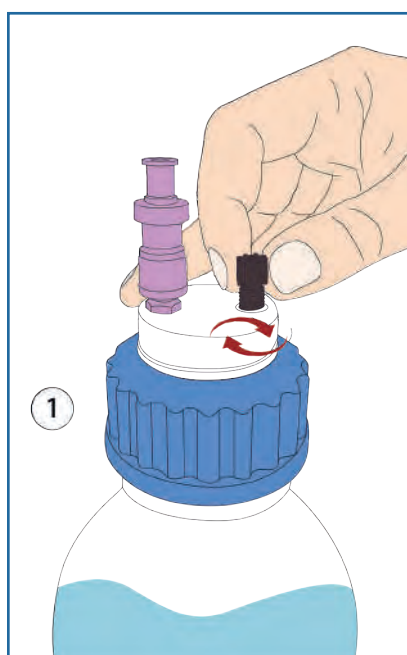

- Insert the 2 in 1 fitting into its proper thread, without fully tightening it.

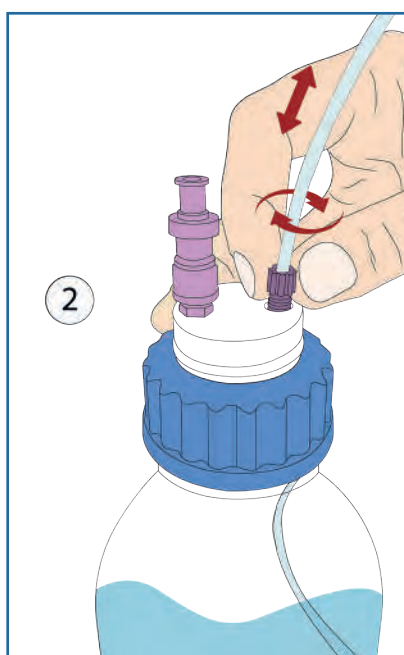

- Insert your tube into the 2 in 1 fitting, adjust its length and then screw the fitting until the tube stops moving.

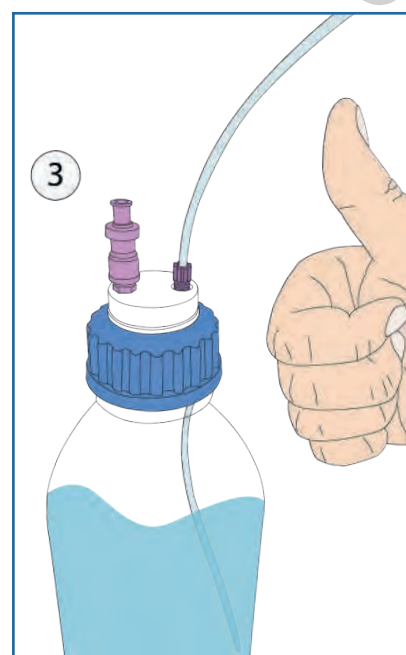

- Installation completed!

DESCRIPTION	FOR TUBES (OD)	COLOR	QTY/PK	REFERENCE
Fitting 2 in 1 Type I Black	of 1/16" to 1mm	Black	5	CC-ONE-1BL
Fitting 2 in 1 Type I Violet	of 1/16" to 1mm	Purple	5	CC-ONE-1V
Fitting 2 in 1 Type II Black	of 1/8" to 1/16"	Black	5	CC-ONE-2BL
Fitting 2 in 1 Type II Violet	of 1/8" to 1/16"	Purple	5	CC-ONE-2V



SMART WASTE CAPS

ACCESSORIES : LEAK FITTINGS

GUIDE FOR LEAK FITTING CHANGE :

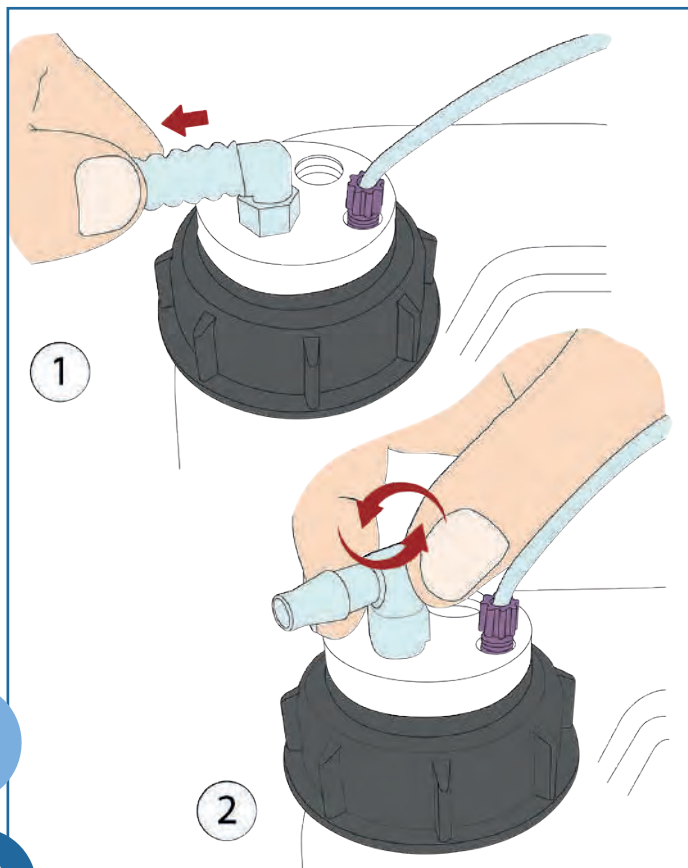

Remove the tube from the Leak fitting to change, and then unscrew the Leak fitting.

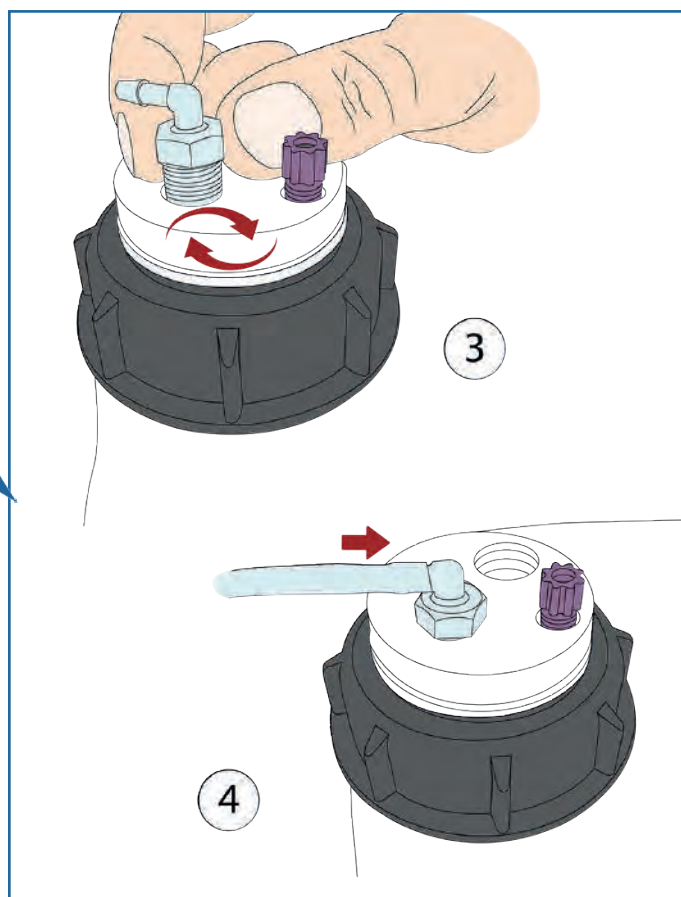

Screw the new Leak fitting and insert your new tube. Your new connection is ready!

SMART WASTE CAPS

ACCESSORIES : LEAK FITTINGS*

*The illustrations of the products are in CAD and are not contractual.
The leak fittings are made of translucent PP.



STRAIGHT LEAK FITTING / PER UNIT

DESCRIPTION	TUBE DIAMETER (ID)	REFERENCE
Straight leak fitting	3 to 4 mm	RD-34
Straight leak fitting	5 to 6 mm	RD-56
Straight leak fitting	6 to 9 mm	RD-69
Straight leak fitting	9 to 11 mm	RD-911



ANGLED LEAK FITTING / PER UNIT

DESCRIPTION	TUBE DIAMETER (ID)	REFERENCE
Angled leak fitting	3 to 4 mm	RC-34
Angled leak fitting	5 to 6 mm	RC-56
Angled leak fitting	6 to 9 mm	RC-69
Angled leak fitting	9 to 11mm	RC-911



DOUBLE ANGLED LEAK FITTING / PER UNIT

DESCRIPTION	ID	REFERENCE
Double angled leak fitting	5 to 6 mm	RCY-56
Double angled leak fitting	6 to 9 mm	RCY-69

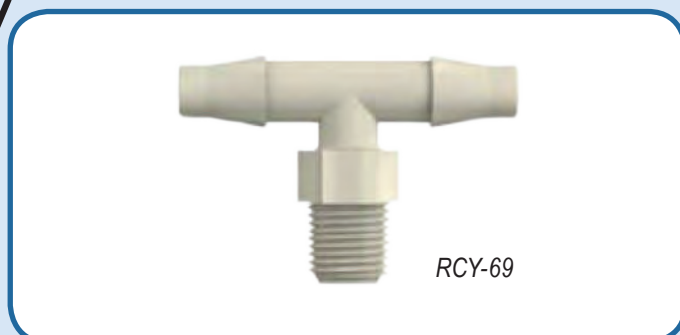

SMART WASTE CAPS

ACCESSORIES : CONNECTORS AND ADAPTERS



Y CONNECTORS*, PER UNIT

DESCRIPTION	TUBE ID	REFERENCE
Y-Connector 3 mm	3 mm	Y-3
Y-Connector 5 mm	5 mm	Y-5
Y-Connector 7 mm	7 mm	Y-7
Y-Connector 9 mm	9 mm	Y-9
Y-Connector 11 mm	11 mm	Y-11

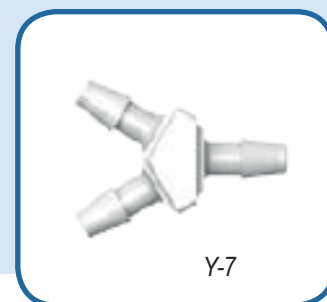
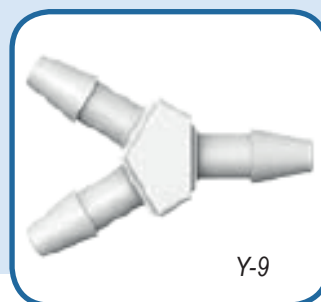
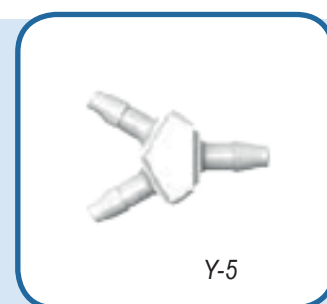
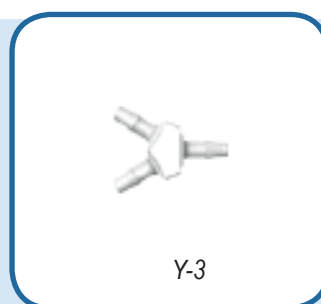

CONICAL REDUCERS AND ADAPTERS

FOR DIFFERENT SIZES OF TUBES

INLET DIAMETER	OULET DIAMETER	REFERENCE
4,2 - 8 mm	4,2 - 8 mm	CR-1
10,5 - 16 mm	6,5 - 12 mm	CR-3
11 - 15 mm	7 - 12 mm	CR-6

*The illustrations of the products are in CAD and are not contractual.
The connectors are made of translucent PP.

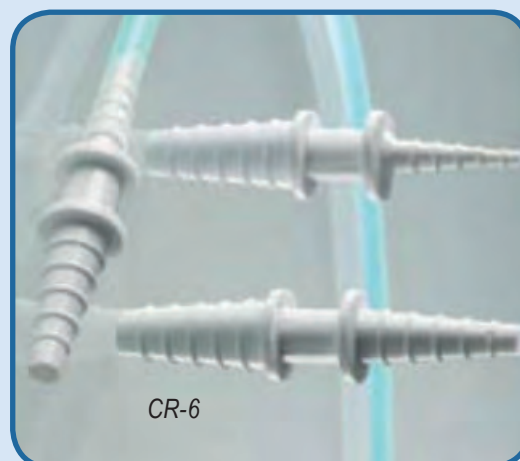

SMART WASTE CAPS

ACCESSORIES : TUBES AND BLIND PLUG



PTFE TUBES



OD	ID	REFERENCE*	QUANTITY
1/4"	6,3 mm	TP14	1 meter
3/16"	3 mm	TP316	1 meter
1/8"	1,6 mm	TP18	1 meter
1/16"	1,0 mm	TP16	1 meter

TYGON™ TUBES

OD	ID	REFERENCE*	QUANTITY
9,5 mm	6,4 mm	TYG-64	1 meter
19,1 mm	12,7 mm	TYG-127	1 meter

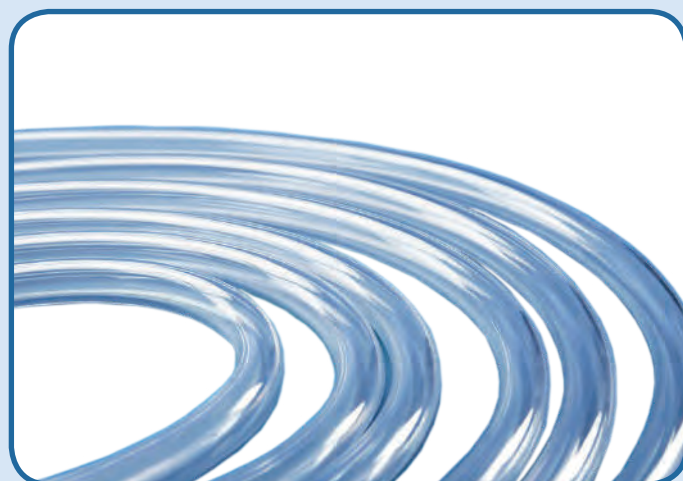

BLIND PLUGS

THEY CLOSE THE UNUSED INLETS OF YOUR SMART WASTE CAPS



FOR	REFERENCE	QUANTITY
1/8" or 1/16" fitting	VP-F18	Per 10
Leak fitting	VP-LEAK	Per 5
Charcoal cartridge fitting	VP-CA	Unit

SMART WASTE CAPS

ACCESSORIES : QUICK CONNECT FITTINGS



SMART HEALTHY CAPS OR SMART WASTE CAPS WITH QUICK CONNECT FITTINGS (WITH OR WITHOUT SHUTOFF VALVE)

Create your own reference!

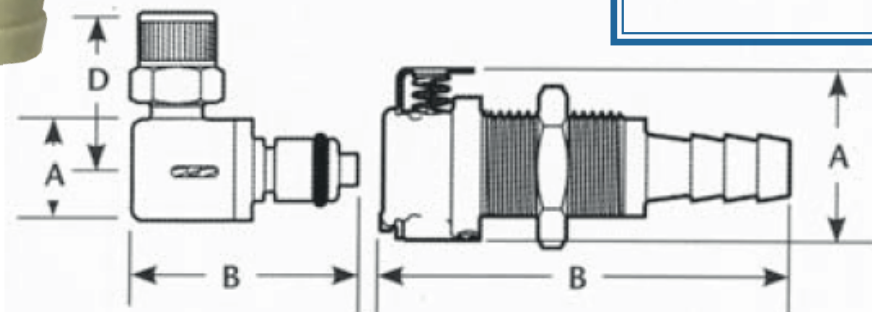
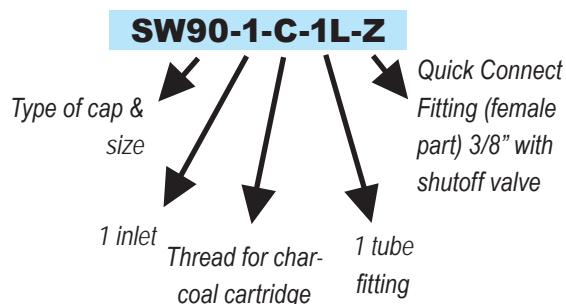

A = Height/Diameter (mm)
B = Total length (mm)
D = Elbow radial length (mm)

FEMALE PART

DESCRIPTION	OUTLET	PASSAGE	REFERENCE	A	B
Quick Connect (female part) without shutoff valve	1/16" (1,6 mm)	3,2mm	S	22,35	35,56
	1/8" (3,2 mm)	3,2mm	T	22,35	41,91
	1/4" (6,4 mm)	3,2mm	U	22,35	46,99
	3/8" (9,5mm)	6,4mm	V	25,40	49,53
Quick Connect (female part) with shutoff valve	1/16" (1,6 mm)	3,2mm	W	22,35	35,56
	1/8" (3,2 mm)	3,2mm	X	22,35	41,91
	1/4" (6,4 mm)	3,2mm	Y	22,35	46,99
	3/8" (9,5mm)	6,4mm	Z	25,40	49,53

ASK US FOR ADVICE FOR YOUR CUSTOM CONFIGURATIONS!

SMART WASTE CAPS





ACCESSORIES : QUICK CONNECT FITTINGS

CHOOSE THE MALE QUICK CONNECT FITTING THAT BEST SUITS YOUR NEEDS AND MODULATE THE CONNECTION ACCORDING TO YOUR WISHES.

MALE PART

SW55-C-Z &
QC64-38-CD



TERMINATION	OUTLET	PASSAGE	REFERENCE WITH SHUTOFF	REFERENCE NO SHUTOFF	A	B	D
	1/16" (1,6mm)	3,2mm	QC32-116-CD-C	QC32-116-CD	12,70	20,32/ 37,34	-
	1/8" (3,2mm)	3,2mm	QC32-18-CD-C	QC32-18-CD	12,70	26,67/ 42,42	-
	1/4" (6,4mm)	3,2mm	QC32-14-CD-C	QC32-14-CD	12,70	30,48/ 43,43	-
	1/4" (6,4mm)	3,2mm	QC32-14-CC-C	QC32-14-CC	12,70	27,69/ 30,73	22,86
	1/4-28	3,2mm	QC32-14-TFP-C	QC32-14-TFP	18,29	39,37	-
	1/4" (6,4mm)	6,4mm	QC64-14-CD-C	QC64-14-CD	16,00	34,29/ 50,80	-
	3/8" (9,5mm)	6,4mm	QC64-38-CD-C	QC64-38-CD	16,00	34,29/ 46,23	-
	1/4" (6,4mm)	6,4mm	QC64-14-CC-C	QC64-14-CC	16,00	30,99/ 34,54	24,38
	3/8" (9,5mm)	6,4mm	QC64-38-CC-C	QC64-38-CC	16,00	32,51/ 36,06	24,38

ATTENTION: MALE / FEMALE COMPATIBILITY IS ONLY ENSURED IF THE PASSAGE DIAMETER IS THE SAME FOR BOTH PARTS!

SAFETY FUNNELS

A WIDE RANGE TO MEET ALL YOUR NEEDS



SAFETY FUNNELS

A WIDE RANGE TO MEET ALL YOUR NEEDS



SAFETY FUNNELS.

FUNNEL WITH HINGED LID FOR RESIDUAL SOLVENTS

It is installed on a can or a barrel of residual solvent. It is practical and you can equip it with an activated charcoal cartridge if the storage is in a non-ventilated room.

The activated charcoal cartridge prevents the creation of an overpressure in the can if it is exposed to heat.



SW55-FSC*

**Activated charcoal cartridge sold separately (see page 24)*



SW55-FSB

DESCRIPTION	REFERENCE WITH CARTRIDGE*	REFERENCE WITHOUT CARTRIDGE
Smart Waste Caps funnel with hinged lid for can S55	SW55-FSC	SW55-FSB
Smart Waste Caps funnel with hinged lid for can S60	SW60-FSC	SW60-FSB
Smart Waste Caps funnel with hinged lid for can S90	SW90-FSC	SW90-FSB
Smart waste caps funnel with hinged lid for space-saving can S50	SWB-FSC	SWB-FSB
Smart Waste Caps funnel with hinged lid for metallic barrel	SWBA-FSC	SWBA-FSB

SAFETY FUNNELS

FUNNEL WITH HINGED LID FOR RESIDUAL SOLVENTS

This funnel has a double interest: the direct discharge through the funnel of all your waste, but also the collection of effluent from your HPLC systems with the integration of inlet fittings and / or leak fittings on the funnel.

DESCRIPTION	THREAD	REFERENCE
Funnel with hinged lid with 1 activated charcoal cartridge, 2 inlets 1/8" (3.2mm) and 1 leak fitting (6 to 9mm)	S55	SW55-2-1L-FSC
	S60	SW60-2-1L-FSC
	S90	SW90-2-1L-FSC
	Metallic barrel	SWBA-2-1L-FSC
	Space-saving can	SWB-2-1L-FSC
Funnel with hinged lid with 1 activated charcoal cartridge, 2 inlets 1/8" (3.2mm) and 2 leak fittings (6 to 9mm)	S55	SW55-2-2L-FSC
	S60	SW60-2-2L-FSC
	S90	SW90-2-2L-FSC
	Metallic barrel	SWBA-2-2L-FSC
	Space-saving can	SWB-2-2L-FSC
Funnel with hinged lid with 1 activated charcoal cartridge, 2 inlets 1/8" (3.2mm) and 3 leak fittings (6 to 9mm)	S55	SW55-2-3L-FSC
	S60	SW60-2-3L-FSC
	S90	SW90-2-3L-FSC
	Metallic barrel	SWBA-2-3L-FSC
	Space-saving can	SWB-2-3L-FSC

SW55-2-1L-FSC



Create your own reference !

SW55 - 2 - 2L - FSC

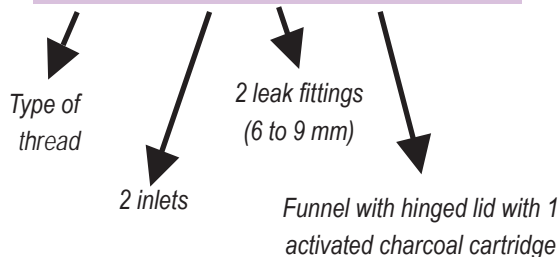

For any special configuration (exemple: 2 entries of different diameters), contact us directly!

SAFETY FUNNELS

FUNNEL WITH STOPCOCK

It secures the storage of your residual solvents, equipped with an activated charcoal cartridge for filtration of unobstructed vapors. It is possible to add entries and / or leak fittings by creating your own reference (see below).

FOR CANS	REFERENCE
S51/55	SW55-C-FS
S60/61	SW60-C-FS

Create your own reference !

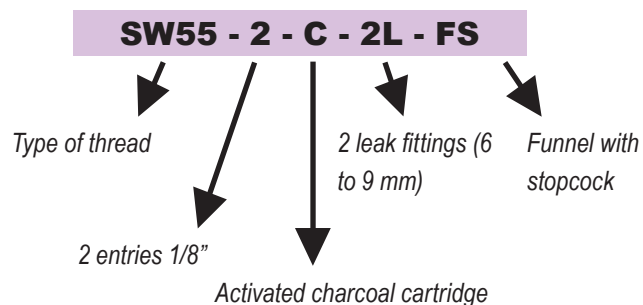

Note : Standard references are not equipped with additional inlets. For another configuration, follow the explanation above and create your own reference!

SAFETY FUNNEL

FUNNEL WITH BALL VALVE WITH HIGH SPILL CAPACITY

Funnel with ball valve allowing to quickly pour used solvents, for plastic can from 5 to 50L.

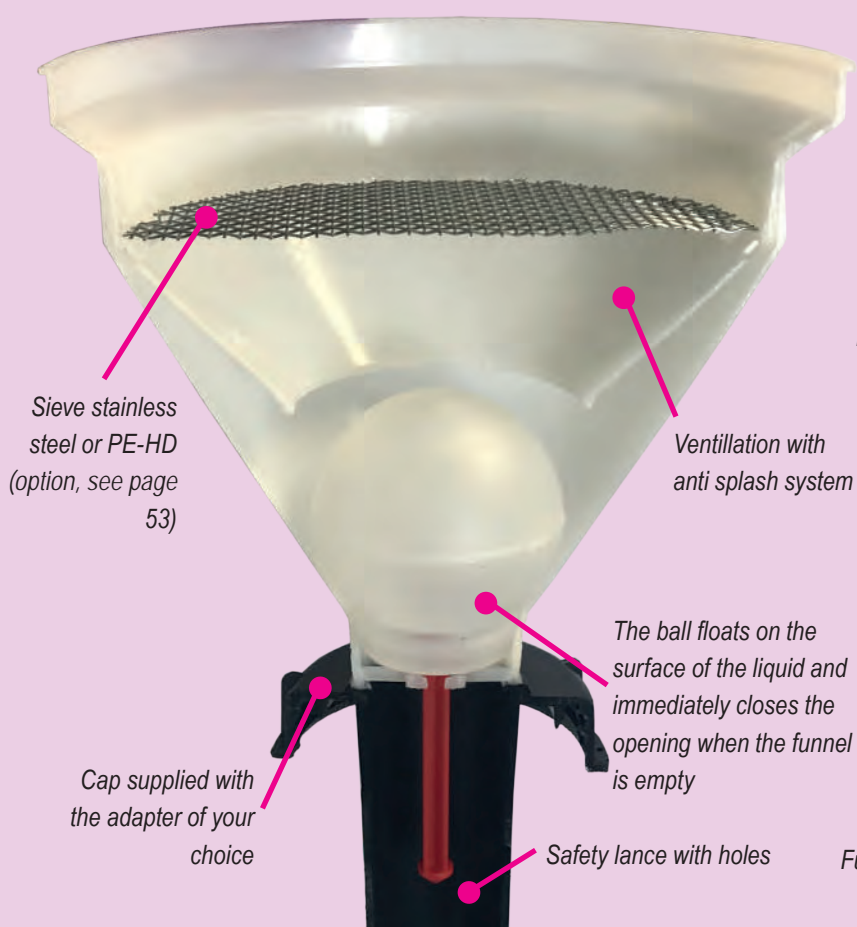

Funnel with ball valve with activated charcoal cartridge



Funnel with ball valve without activated charcoal cartridge

DESCRIPTION	REFERENCE WITHOUT CARTRIDGE	REFERENCE WITH CARTRIDGE *
Funnel with ball valve for can S55	ET55-B	ET55-C-B
Funnel with ball valve for can S60	ET60-B	ET60-C-B
Funnel with ball valve for can S90	ET90-B	ET90-C-B
Funnel with ball valve for space-saving can S50	ETB-B	ETB-C-B
Funnel with ball valve for metallic barrel	ETBA-B	ETBA-C-B

* Activated charcoal cartridge are to be ordered separately

SAFETY FUNNEL

FUNNEL WITH BALL VALVE WITH SMART WASTE CAP FONCTION

Funnel with ball valve for 5 to 20L can and metallic barrel, with or without external solvent inlet. It can be equipped with the same functions as a conventional Smart Waste Cap (leak fittings, activated charcoal cartridge, inlets) to directly receive the effluent from your HPLC chains without passing through the funnel.



Funnel with ball valve with activated charcoal cartridge



For any other configuration, contact us directly!

DESCRIPTION	THREAD	REFERENCE
Funnel with ball valve with an adapter for the activated charcoal cartridge, 2 fittings 1/8" and 1 leak fitting (6 to 9 mm)	S55	ET55-2-C-1L
	S60	ET60-2-C-1L
	S90	ET90-2-C-1L
	NALGENE® B83	ETB83-2-C-1L

SAFETY FUNNEL

FUNNEL WITH BALL VALVE WITH HIGH SPILL CAPACITY FOR BARREL

DESCRIPTION	REFERENCE
Funnel with ball valve for metallic or plastic barrel	ETBA-B
Funnel with ball valve for metallic or plastic barrel + 1 leak fitting (6 to 9 mm)	ETBA-1L
Funnel with ball valve for metallic or plastic barrel + 2 leak fittings (6 to 9 mm)	ETBA-2L



ETBA-B

DESCRIPTION	REFERENCE
Sieve in polyethylene (HD-PE)	TAM-PE *
Sieve in stainless steel	TAM-LUX *

* Add the option reference at the end of the funnel reference.



SAFETY FUNNEL

ELECTRICALLY CONDUCTIVE FUNNEL WITH BALL VALVE

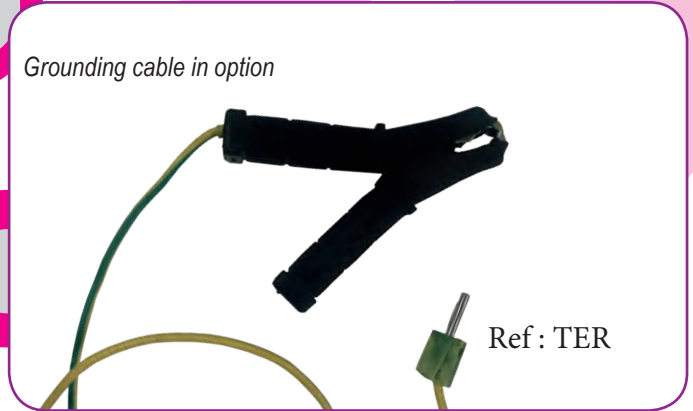

DESCRIPTION	THREAD	REFERENCE
Electrically conductive funnel with ball valve equipped with a stainless steel sieve	S55	ET55-B-EL
	S60	ET60-B-EL
	S90	ET90-B-EL
	NALGENE® B83	ETB83-B-EL
Electrically conductive funnel with ball valve equipped with a stainless steel sieve and an adapter for an activated charcoal cartridge	S55	ET55-C-EL
	S60	ET60-C-EL
	S90	ET90-C-EL
	NALGENE® B83	ETB83-C-EL

ELECTRO CONDUCTIVE CANS



VOLUME (LITER)	THREAD	REFERENCE
10	S60 / DIN 61	B10-61-EL
20	S60 / DIN 61	B20-61-EL
30	S60 / DIN 61	B30-61-EL

SAFETY FUNNEL

NOTES

.....

.....

.....

.....

.....

.....

.....

.....

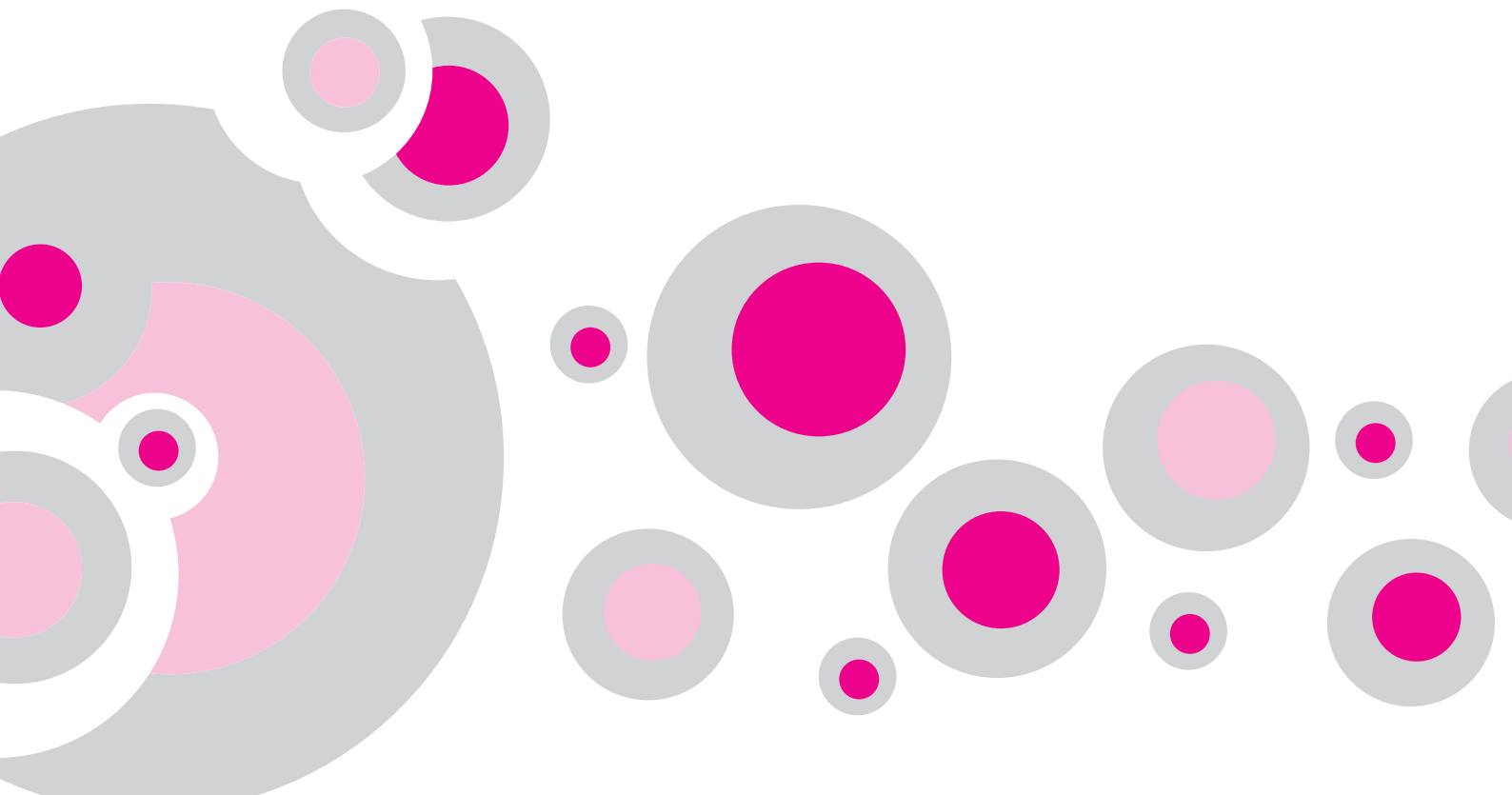

RETENTION TRAYS & CANS

CANS IN *HD-PE* CHIMICALLY INERT

VOLUME (LITER)	THREAD	REFERENCE
2,5 L	GL45	B2-45
5 L	GL45	B5-45
5 L	S55	B5-55
10 L	S55	B10-55
20 L	S60	B20-60
5 L (space-saving can)	S50	BS-GP

How to determine the thread of your can?

* S = ISO's norm

* DIN = DIN's norm

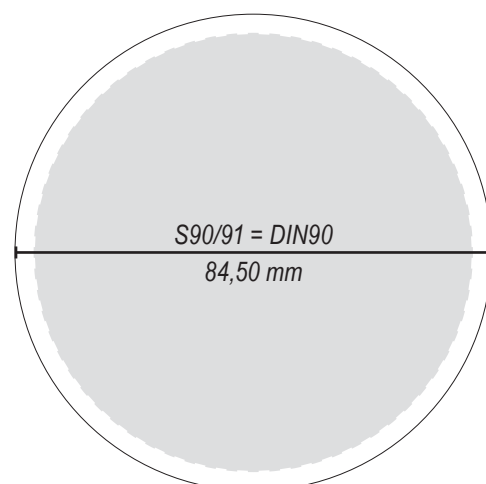
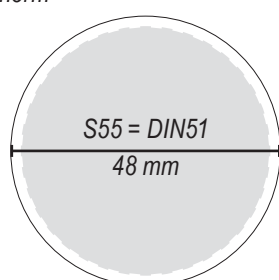

LOOSENING WRENCH



RETENTION TRAYS & CANS

RETENTION TRAYS

Avoid accidental overflow. A.I.T offers 3 sizes of retention trays. With a grid to keep the can dry.



DESCRIPTION	DIMENSION (MM)		CAPACITY	REFERENCE
	EXTERNAL	INTERNAL		
Little Retention Tray	H.70 × D.347 × W.230	D.280 × W.165	3L	BAC-R-3
Medium Retention Tray	H.75 × D.437 × W.285	D.380 × W.220	5L	BAC-R-5
Large Retention Tray	H.75 × D.485 × W.335	D.420 × W.265	8L	BAC-R-8

H : height

W : width

D : depth

SPACE-SAVING CAN IN HD-PE

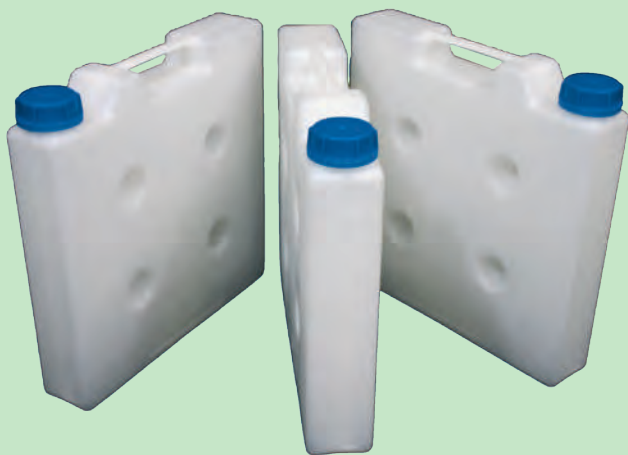

BS-GP

VOLUME (LITER)	THREAD
5	GL45
DIMENSION (MM) EXT.	REFERENCE
H. 335 x D. 335 x W. 65	BS-GP

INDEX

REFERENCE	PAGE	REFERENCE	PAGE	REFERENCE	PAGE
AD-2T-GL45	16	B20-61-EL	54	ET60-B	51
AD-32-45-P	18	B2-45	56	ET60-B-EL	54
AD-32-45-T	18	B30-61-EL	54	ET60-C-B	51
AD-38-45-T	18	B5-45	56	ET60-C-EL	54
AD-38-45-P	18	B5-55	56	ET90-2-C-1L	52
AD-40-32-P	38	BAC-R-3	57	ET90-B	51
AD-40-38-P	38	BAC-R-5	57	ET90-B-EL	54
AD-40-45-P	18	BAC-R-8	57	ET90-C-B	51
AD-40-45-P	38	BS-GP	57	ET90-C-EL	54
AD-40-45-T	18	CC-ONE-1BL	21, 39	ETB83-2-C-1L	52
AD-45-32-P	38	CC-ONE-1V	21, 39	ETB83-B	51
AD-45-38-P	38	CC-ONE-2BL	21, 39	ETB83-B-EL	54
AD-45-55-P	38	CC-ONE-2V	21, 39	ETB83-C	51
AD-45-EM	10	CR-1	42	ETB83-C-EL	54
AD45-PAIL-1L	36	CR-3	42	ETBA-1L	53
AD-4T-GL45	16	CR-6	42	ETBA-2L	53
AD-55-60-P	38	DIS 10	11	ETBA-B	51, 53
AD-55-90-P	38	DIS 25	11	ETBA-C-B	51
AD-60-90-P	38	ET55-2-C-1L	52	ETB-B	51
AD-CPC-JUST	27	ET55-B	51	ETB-C-B	51
AD-D-JUST	27	ET55-B-EL	54	F16-1	22
B10-55	56	ET55-C-B	51	F14	22
B10-61-EL	54	ET55-C-EL	54	F16	22
B20-60	56	ET60-2-C-1L	52	F18	22

INDEX

REFERENCE	PAGE	REFERENCE	PAGE	REFERENCE	PAGE
F18-25	22	GL5000-C	19	QC32-18-CD-C	45
F316	22	GL500-A	19	QC64-14-CC	45
FC-100	24	GL500-C	19	QC64-14-CC-C	45
FC-100-C	24	KEY-55-60	56	QC64-14-CD	45
FC-100-KOH	24	MULTI-MOL-6-4L	36	QC64-14-CD-C	45
FC-180	26	QC32-116-CD	45	QC64-38-CC	45
FC-25	24	QC32-116-CD-C	45	QC64-38-CC-C	45
FC-250	25	QC32-14-CC	45	QC64-38-CD	45
FC-25-C	24	QC32-14-CC-C	45	QC64-38-CD	45
FC-50	24	QC32-14-CD	45	QC64-38-CD-C	45
FC-500	25	QC32-14-CD-C	45	R14	22
FC-50-C	24	QC32-14-TFP	45	R16	22
FC-90	26	QC32-14-TFP-C	45		
FC-AD-CPC	27	QC32-18-CD	45		
FC-AD-JUST	27				
FC-D	26				
FC-D-90	26				
GL1000-A	19				
GL1000-C	19				
GL2000-A	19				
GL2000-C	19				
GL250-A	19				
GL250-C	19				
GL5000-A	19				

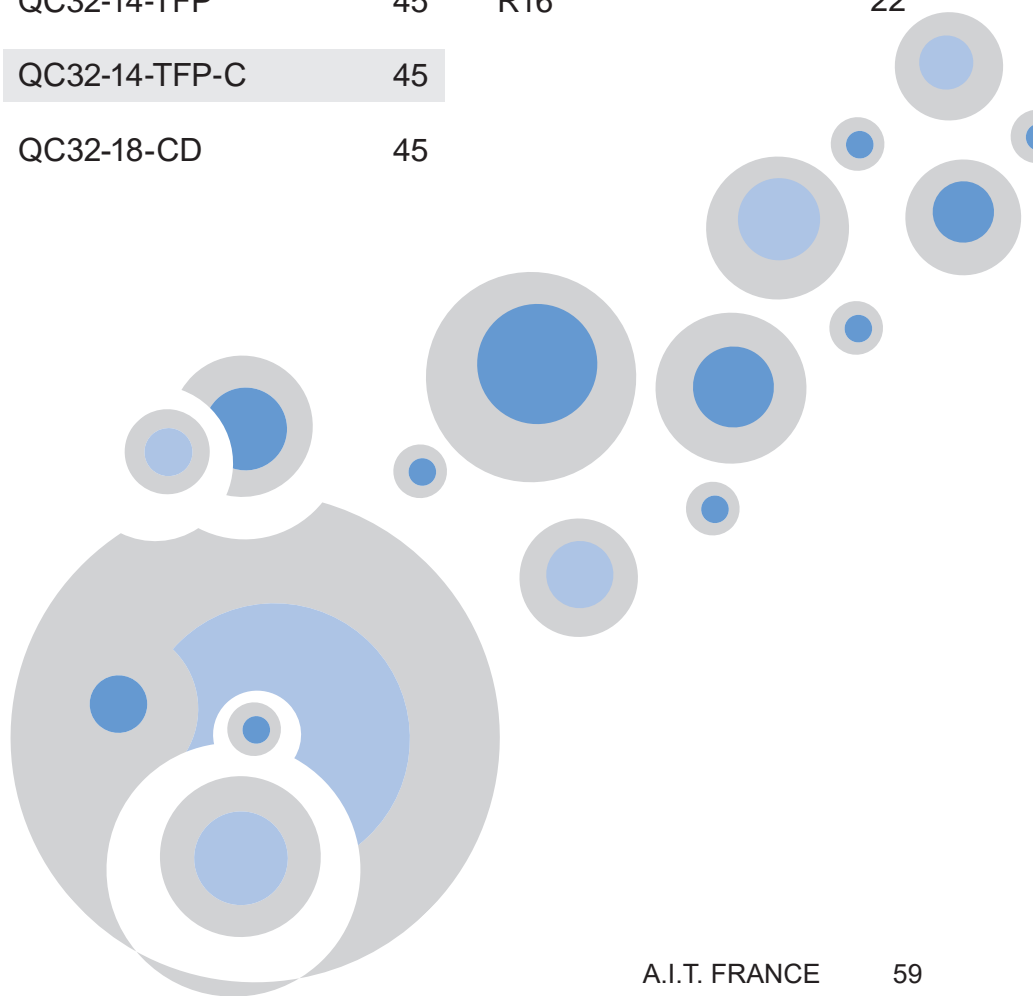

INDEX

REFERENCE	PAGE	REFERENCE	PAGE
R18	22	SHCB53-FSP-B	15
R316	22	SHCBA-FSP-A	15
RC-34	41	SHCBA-FSP-C	15
RC-56	41	SHCBA-FSP-B	15
RC-69	41	SHC-1-EM	10
RC-911	41	SHC-P-A	13
RCY-56	41	SHC-P-B	13
RCY-69	41	SHC-1PV	11
RD-34	41	SHC-1-SEPT	12
RD-56	41	SHC-2	9
RD-69	41	SHC-2-EM	10
RD-911	41	SHC-P-A-C	13
SHC-1	9	SHC-P-2B	13
SHC45-FSP-A	15	SHC-2PV	11
SHC45-FSP-C	15	SHC-2-SEPT	12
SHC45-FSP-B	15	SHC-3	9
SHC55-FSP-A	15	SHC-3-EM	10
SHC55-FSP-C	15	SHC-3PV	11
SHC55-FSP-B	15	SHC-SV-PREP	20
SHC60-FSP-A	15		
SHC60-FSP-C	15		
SHC60-FSP-B	15		
SHCB53-FSP-A	15		
SHCB53-FSP-C	15		

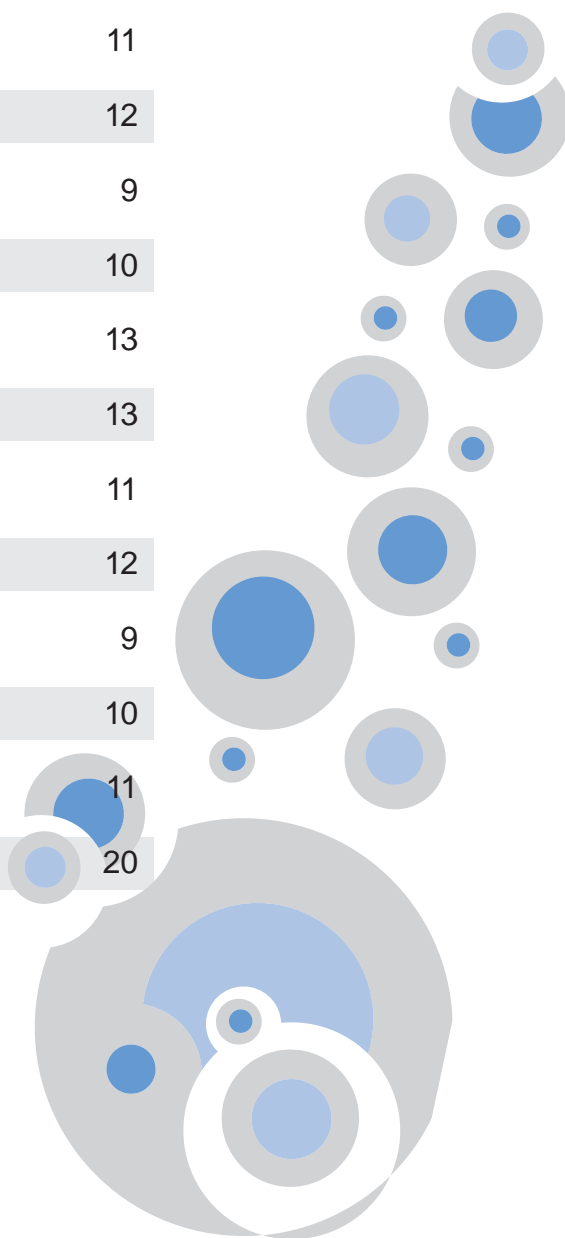

INDEX

REFERENCE	PAGE	REFERENCE	PAGE	REFERENCE	PAGE
SHC-3-SEPT	12	SHC-V4	10	SW55-FSC	48
SHC-4	9	SW45-1-C-1L	30	SW60-1-C-1L	31
SHC-4-EM	10	SW45-1-C-2L	30	SW60-1-C-4L	31
SHC-4PV	11	SW45-2-C-1L-LI	35	SW60-2-1L-FSC	49
SHC-5	9	SW45-2-C	30	SW60-2-2L-FSC	49
SHC55-P-A	14	SW45-2-C-2L	30	SW60-2-3L-FSC	49
SHC55-P-A-B	14	SW45-4-C-1L	30	SW60-2-C	31
SHC55-P-A-C	14	SW45-5-C	30	SW60-2-C-1L	31
SHC55-P-B	14	SW45-C-2L	30	SW60-2-C-4L	31
SHC55-P-2A-B	14	SW45-C-3L	30	SW60-5-C-1L	31
SHC55-P-3A	14	SW55-1-C-3L	29	SW60-6-C	31
SHC60-P-A	14	SW55-2-1L-FSC	49	SW60-C-1L	31
SHC60-P-A-C	14	SW55-2-2L-FSC	49	SW60-C-FS	50
SHC60-P-B	14	SW55-2-3L-FSC	49	SW60-FSB	48
SHC60-P-2A-C	14	SW55-2-C-1L	29	SW60-FSC	48
SHC-SV	20	SW55-2-C-2L	29	SW90-1-C-1L-Z	44
SHC-SV10	20	SW55-3-C-2L	29	SW90-2-1L-FSC	49
SHC-SV50	20	SW55-3-C-3L	29	SW90-2-2L-FSC	49
SHC-SV-AB	20	SW55-4-C	29	SW90-2-3L-FSC	49
SHC-SV-AB10	20	SW55-4-C-1L	29	SW90-2-C	33
SHC-SV-AB50	20	SW55-5-C	29	SW90-2-C-1L	33
SHC-V1	10	SW55-C-Z	44	SW90-2-C-2L	33
SHC-V2	10	SW55-C-FS	50	SW90-3-C	33
SHC-V3	10	SW55-FSB	48	SW90-3-C-1L	33

INDEX

REFERENCE	PAGE	REFERENCE	PAGE
SW90-3-C-2L	33	SWBA-2-3L-FSC	49
SW90-4-C	33	SWBA-FSB	48
SW90-4-C-1L	33	SWBA-FSC	48
SW90-FSB	48	SWB-FSB	48
SW90-FSC	48	SWB-FSC	48
SWB-1-C-1L	31	TAM-LUX	53
SWB-1-C-3L	31	TAM-PE	53
SWB-2-1L-FSC	49	TER	54
SWB-2-2L-FSC	49	TP16	23, 43
SWB-2-3L-FSC	49	TP14	23, 43
SWB-2-C-1L	31	TP18	23, 43
SWB-3-C	31	TP316	23, 43
SWB-5-C	31	TYG-127	23, 43
SWB-5-C-1L	31	TYG-64	23, 43
SWB53-2-C	34	VP-CA	43
SWB53-4-C-1L	34	VP-F18	22, 43
SWB53-C-1L	34	VP-LEAK	43
SWB53-C-3L	34	Y-11	42
SWB83-2-C	34	Y-3	42
SWB83-4-C-1L	34	Y-5	42
SWB83-C-1L	34	Y-7	42
SWB83-C-3L	34	Y-9	42
SWBA-2-1L-FSC	49		
SWBA-2-2L-FSC	49		

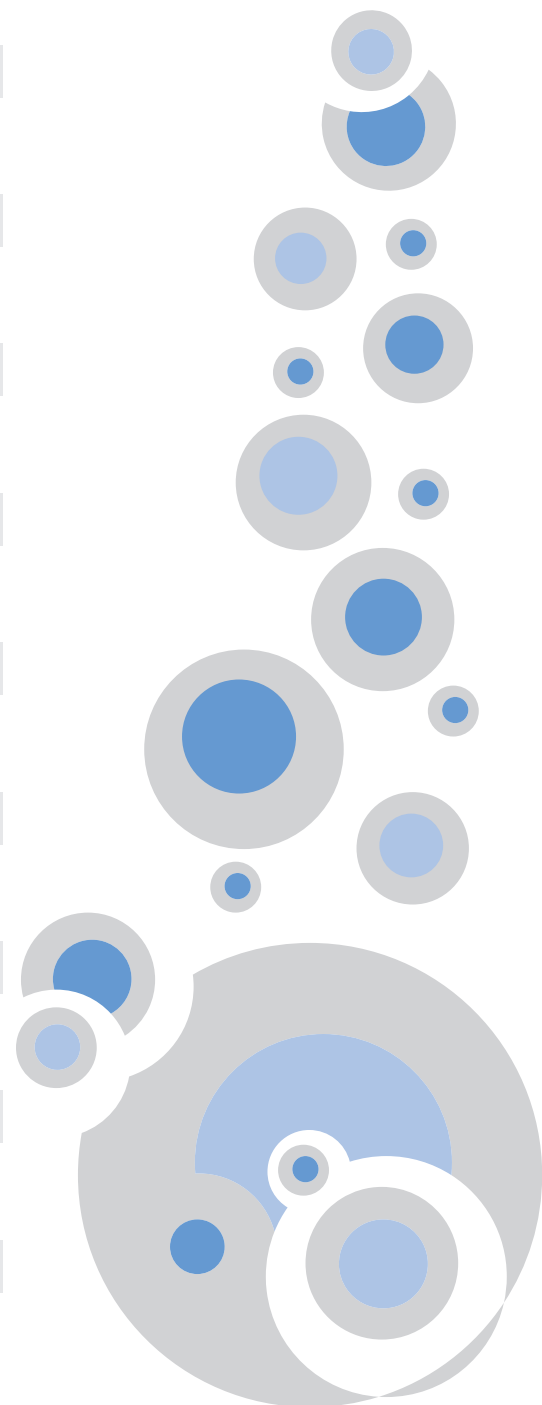



TO PROTECT YOUR HEALTH

A.I.T. FRANCE
117 rue de Stalingrad
78800 Houilles

Phone : +33 (0) 1 34 93 10 80
Fax : +33 (0) 1 34 93 45 67
E-mail : aitfrance@aitfrance.fr