



Starna Scientific The Spectroscopy Specialists

Cell/Cuvettes for all
Spectrophotometer
Fluorimeter and
Laser applications



Starna scientific

Introduction to Starna®

The wide variety of Starna® products in this catalogue are manufactured in the Starna Scientific Ltd (formerly Optiglass Ltd) factory founded in 1964, whose lineage of optical expertise is traceable to the early part of the last century.

Starna Scientific is the manufacturing division of the international group of Starna® companies, who have a recognised world-wide reputation for quality, service, innovation and co-operation in the production and supply of spectrophotometer cells, optical components and certified reference materials.

During the 1950s, the founding members of the company developed and perfected the technique of fully fusing optically polished component parts by heat alone, without distortion. This major advance transformed the design and production of spectrophotometer cells and associated products. Continual development and improvement is reflected in the high quality world class Starna® products.

All manufacturing processes are carried out in an ISO 9000 certified production facility, from design and development of product to customised production machinery. The unique blend of skills including: cutting, slicing, grinding, polishing, conventional drilling, ultrasonic drilling and fusing as well as metallic, multi-layer and anti-reflection coating in one of many coating plants, achieves a complete vertically integrated manufacturing process.

During manufacture of all component parts, special care is taken to avoid contamination by the use of stringent cleaning processes. Together with mandatory inspection procedures these stringent cleaning processes ensure all products leave the factory in a pristine contamination-free condition, with an unconditional guarantee against faulty workmanship. This special treatment of cells together with internally profiled cells reduces bubble adhesion, particularly important in flow cell applications. In addition to the **ISO 9001** certified manufacturing facility, the **Starna Reference Material Calibration Laboratory** which has been **UKAS** accredited to **ISO 17025** since 2001, also achieved **ISO guide 34** in 2006, the highest level of accreditation, recognised world-wide. The unique combination of manufacturing, application and laboratory skills, permits full traceability throughout the whole production process, making Starna Scientific a unique partner to instrument manufacturers, dealers and retail customers worldwide who require completely independent guaranteed validation reference materials for analytical equipment.

Cell specifications

Starna® spectrophotometer cells and other quartz and glass assemblies, unless precluded by design, are assembled using a fully fused method of construction. This technique, pioneered and used by Starna Scientific since the mid 1950s, ensures that cells are fused into a single homogeneous entity using heat alone, without intermediate bonding materials. All cells are then carefully annealed to remove any residual strain from the fusing process. This ensures maximum physical strength as well as resistance to solvents. With few exceptions, most cells can be used safely with pressure differentials of up to 3 x 10⁵Pa (3 Bar) and some up to 10 x 10⁵Pa (10 Bar).

General specifications

Windows parallel to: better than 3 minutes of arc
 Window flatness to: better than 4 Newton fringes
 Window polish, standard: 60/40 scratch/dig
 Window polish, laser: 20/10 scratch/dig

Material	Path lengths	Tolerance
Glass	less than 10mm	± 0.02mm
Glass	10 to 30mm	± 0.1mm
Glass	40 to 100mm	± 0.2mm
Special Optical Glass	up to 20mm	± 0.01mm
Special Optical Glass	30 to 100mm	± 0.02mm
Quartz	0.01 to 0.05mm	± 0.002mm
Quartz	0.1 to 0.4mm	± 0.005mm
Quartz	0.5 to 30mm	± 0.01mm
Quartz	40 to 100mm	± 0.02mm

Standard window thickness is 1.25mm, polished to better than 4 Newton Fringes per centimetre in the viewing area, typically flat to better than 1 micron (0.001mm) over the window area.

Although cells can be used with most solvents and acidic solutions, fluorinated acids such as Hydrofluoric Acid (HF) in all concentrations should be avoided as they will attack the quartz itself. Strong basic solutions (pH 9.0 and above) will also degrade the surface of the windows and shorten the useful life of the cells.

Flow cells with path lengths of less than 0.5mm are measured by an interference method both before and after final fusing. Calculation on this measurement provides an uncertainty of path length better than 0.2 microns (0.0002mm). Path length certification can be supplied for individual cells for a small additional charge. This should be requested at the time of ordering.

Water absorption band OH content ppm (mg/g) Infrasil ≤ 8, Suprasil 300 ≤ 1.

Window material transmission properties

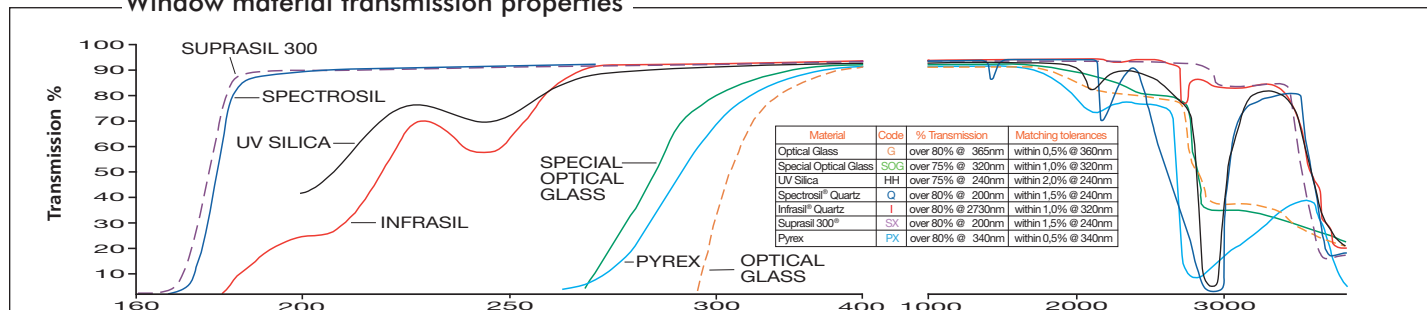

Registered Trade Marks: INFRASIL® & SUPRASIL 300® Heraeus Quarzglas GmbH, Hanau Germany. SPECTROSIL®, Vitreosil® & TSC3® Heraeus Quartz UK Ltd, Wallsend, England. PYREX® Corning Glass Works, U.S.A.

The above information illustrates the approximate transmission ranges of the guaranteed materials used in the production of Starna cells. The spectra does not take into account reflective losses from optical window surfaces which may vary depending on the material measured, resulting in actual measured transmission between 80%T and 90%T. Windows are normally 1.25mm thick and therefore the absorption of the windows themselves can be disregarded for normal analytical purposes.

Contents

Absorption cells	27	Sub-micro, de-bubbler	19
Accessories	28	Ultra-micro	19 & 20
Caps		Long aperture	15 - 17
Cell holders		Round aperture	19 & 20
Cell spacers		Wide aperture	15 - 17
Funnels		Medium aperture	15 & 16
Lids		Fluorescence reference materials	30
Magnetic stir bars		Fluorimeter cells	21 - 25
Mirror coatings		Standard rectangular	21
Quartz block inserts		Micro & semi-micro, with & without stopper	21 & 22
Stoppers		Micro cell adaptors - FCAs	21
Anaerobic cells	12	Sub-micro	22
Aspiration cells, micro and semi-micro	18	Flow cells, all types	14 & 24
CD matching	4	Triangular open top/stopper	23
Cell matching	4 & 2	Constant temperature	25
Cell specifications	2	Gel boat cells	27
Cell stirrer (Spinette)	30	Magnetic stirring cells	26
Colorimeter cells	27	Micro cells / Micro Cells short with lid or stopper	7
Connector fittings	29	Micro cells self-masking with lid or stopper	7
Constant temperature cells	25	Mixing cells	23
Cube cells	23	NIST traceable certified reference materials	30
Cylindrical cells	10	Polarimeter cells	26
Constant temperature	25	Quartz/Pyrex graded seals fused to cells	11
Short path	10	Rectangular cells with small screw caps	12
Short path, micro	10	Reference materials, liquid and glass	30
Standard	10	Refractometer cells	25
Large diameter	10	Screw cap & septum cap cells GL14	12
With tube	10	Semi-micro cells with lid or stopper	6
With graded seal	11	Semi-micro cells self-masking with lid or stopper	6
Demountable cells, short path length	13	Semi Micro cells short	6
Dissolution cell construction	16	Semi Micro cells short, self-masking	6
Divided cells	23	Small screw cap & septum cap cells	12
Dual path length cells	23	Standard rectangular cells with lid or stopper	5
Dye laser cells	26	Sub-micro cells with lid or vaned stopper	8
Flow cells	14-20	Sub-micro and multi-micro cells short	8
Dissolution cells	15-17	Sub-micro cells, low headspace	9
Fittings	29	Sub-micro cells with stopper	9
Fluorimeter	24	Suction cells	18
Fluorimeter HPLC	24	Tandem cells	23
HPLC	18	Terms of sale	30
Short path	14 & 17	Transmission specifications	2-4
Short path, demountable	14	Ultra-micro cells	9
In-line and Microscope analysis, in line	13-14	Ultra-micro lens cell	9 & 23
Standard & Semi-micro	15	UHV cells with stopcock	11
Sub-micro	16	Z Height dimension	4

How to order

Essential ordering information is shown under the **Blue column headings** throughout the catalogue. Detail shown under the black headings is additional descriptive and dimensional information and need not be included. eg. to order Type **1/I/10** (Standard Rectangular, Infrasil, 10mm Path length)

Type No.	Window Materials	Path Length	Internal Width	External L	External W	External H	Nominal Vol. ml
1	G, SOG, PX, HH, Q, I, SX	10	10	12.5	12.5	45	3.500

eg. to order Type **19.01/Q/1/Z8.5** (Ultra-micro, Spectrosil, 1mm path length, 8.5mm Z dimension)

Type No.	Window Materials	Path Length	Z Height	Sample chamber W	Sample chamber H	External L	External W	External H	Nominal Vol. ml
19.01	SOG, Q	1	8.5, 15, 20	5	1	12.5	12.5	40.5	0.0050

Material specifications

Starna Scientific offer five primary window materials, Optical Glass (G) and Special Optical Glass (SOG) for the visible range. Spectrosil® Quartz (Q) or equivalent for the far UV range, Infrasil® Quartz (I) or equivalent for the near infra-red (IR) as well as Suprasil 300® (SX) or equivalent which transmits from the far UV to the near infra-red. Other window materials are also available such as Pyrex® (PX) and UV Silica (HH).

If a specific window material is required and is not shown in this catalogue please contact us for availability. All materials used are fully guaranteed to transmit greater than 80% over the following usable wavelength range:

Optical Glass	G	334 through 2500 nm
Special Optical Glass	SOG	320 through 2500 nm
Borosilicate	PX	325 through 2500 nm
UV Silica	HH	220 through 2500 nm
Spectrosil® Quartz	Q	190 through 2700 nm
Infrasil®	I	220 through 3800 nm
Suprasil 300® Quartz	SX	190 through 3500 nm

For fluorescent applications Spectrosil® is the recommended window material, as it does not exhibit any background fluorescence. Some other materials, especially glass and lower grades of quartz may have some background fluorescence.

The meticulous care taken in the quality of the polishing and unique construction of regular Starna® quartz fluorescent cells brings them within tolerances which are sufficiently stringent for them to be used in laser applications. These techniques are particularly relevant in the manufacture of much larger Ultra High Vacuum (UHV) cells.

Cell matching

Modern production and fusing techniques, together with consistent raw materials, have virtually eliminated the need for transmission matching in regular standard high grade quartz cells.

The extremely accurate physical path length tolerances used in production, stated on page 2, are essential especially on very short path lengths, for instance in dissolution measurements where multiple short path length cells may be used. Such flow cells Types 73, 74, 75, 583, 584 and 585 each have a unique fully traceable serial number engraved on the window. Cells with path lengths less than 0.5mm are measured using an interference method both before and after final fusing to provide a path length uncertainty calculation better than 0.2 microns (0.0002 mm). A certificate of path length and full production traceability can be provided for each individual cell on request, for a small additional charge.

Cells manufactured for **Circular Dichroism(CD)** must have strain-free oriented windows and the complete cell carefully annealed. This process incurs an additional charge for each cell. Cells required for **CD** must have this suffix **CD** added to the part number e.g. 34/Q/50/CD.

Z Height dimension - IMPORTANT!

The 'Z' height is the distance from the bottom of the cell holder cavity to the centre of the incident light beam profile, which can be round, rectangular or curved. For the most efficient use of energy and sample volume the sample chamber aperture should ideally encompass the light beam with a small extra margin to avoid beam clipping.

The 'Z' height of the cell, the distance from the centre of the cell sample chamber aperture to the base of the cell, should match to that of the instrument.

Manufacturers have generally designed their instruments with 'Z' dimensions ranging from 5 to 20mm with 8.5 or 15mm being the most popular.

Choosing the correct cell 'Z' height is very important when the aperture in the cell is very small, as in sub-micro cells and micro flow cells.

The standard 'Z' heights for any cell, where this information is critical, are shown in a separate column in the information tables, headed 'Z' Height. Other 'Z' dimensions can be supplied on request.

The correct 'Z' height should be added to the part number e.g. if 8.5mm is required it should be shown as follows 73.4/SOG/10/Z8.5. As a double check at the time of ordering, it is beneficial to state the instrument make and model number for which the cell is required.

ALL dimensions stated in this catalogue are in millimetres unless otherwise indicated

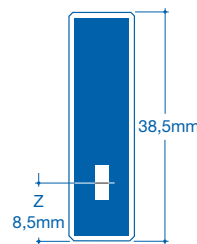
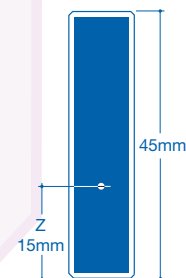

When cells matched for transmission are required, mainly but not exclusively for less consistent materials such as Glass and Special Optical Glass where transmission characteristics from melt to melt differ, each measured cell is given a match code relative to its transmission at a given wavelength as measured on a spectrophotometer. The transmission matching tolerances at measured wavelengths are shown as follows:

Window Material	Matching Tolerance	Measured at Wavelength
Optical Glass	0.5%	350nm
Special Optical Glass	1.0%	320nm
Borosilicate	1.0%	320nm
UV Silica	1.5%	240nm
Spectrosil® Quartz	1.5%	200nm
Infrasil® Quartz	1.5%	240nm
Suprasil 300®	1.5%	240nm

The matching codes are only of real value when comparing new cells as transmission characteristics change during use because of surface contamination or wear due to cleaning processes. Therefore a brand new cell may not identically match an older used cell of the same match code.

Type 1. Macro/Standard Rectangular with lid, and Reduced Volume with lid

- Open top, with non-sealing PTFE cover.
- Polyethylene vaned lid available on request for 10mm cells only, providing a liquid-tight seal. (see page 28)
- Two polished windows.
- Walls polished internally, fine ground externally.
- Suitable for use with all standard cell holders.
- **Type 1/B** has black side walls.
- **Type 1/10/CD** thick base, reduced sample for CD.
- Cell compartment spacers **SPA** available for 1, 2 & 5mm Path length cells (see page 28).

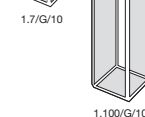
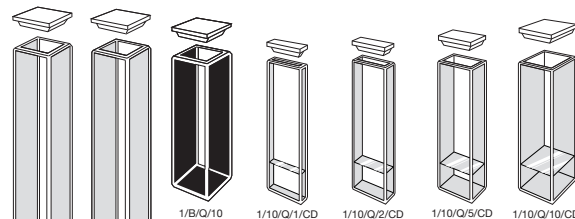
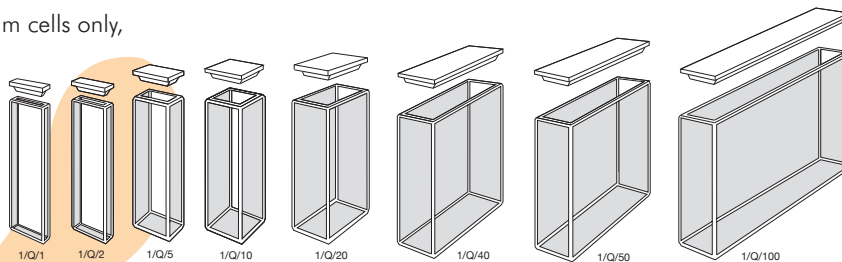

1.100/G/10

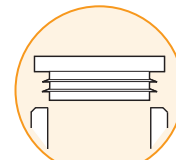
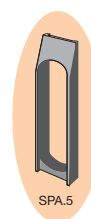

Type No.	Window Materials	Path Length	Internal Width	External			Nominal Vol. ml
				L	W	H	
1	G, SOG, Q, I, SX	1	10	3.5	12.5	45	0.400
1	G, SOG, Q, I, SX	2	10	4.5	12.5	45	0.700
1	G, SOG, Q, I, SX	5	10	7.5	12.5	45	1.700
1	G, SOG, PX, HH, Q, I, SX	10	10	12.5	12.5	45	3.500
1	G, SOG, Q, I, SX	20	10	22.5	12.5	45	7.000
1	G, SOG, Q, I, SX	30	10	32.5	12.5	45	10.500
1	G, SOG, Q, I, SX	40	10	42.5	12.5	45	14.000
1	G, SOG, Q, I, SX	50	9.5	52.5	12.5	45	17.500
1	G, SOG, Q, I, SX	100	9.5	102.5	12.5	45	35.000
1/B	Q	10	10	12.5	12.5	45	3.500
1.7	G	10	10	12.5	12.5	70	6.500
1.100	G	10	10	12.5	12.5	100	10.000
<hr/>							
1/10/CD	Q, I	1	10	3.5	12.5	45	0.275
1/10/CD	Q, I	2	10	4.5	12.5	45	0.450
1/10/CD	Q, I	5	10	7.5	12.5	45	1.200
1/10/CD	Q, I	10	10	12.5	12.5	45	2.500

For GL/14 Screw tops, graded seals & straight bore tubes - See pages 11 & 12

Type 21. Macro/Standard Rectangular with stopper(s), and Reduced Volume with stopper(s)

- Closed by PTFE stopper(s), providing a liquid-tight seal.
- Two polished windows.
- Walls polished internally, fine ground externally.
- Suitable for use with all standard cell holders.
- **Type 21-N** Wide neck.
- **Type 21-LB** With long stopper block.
- **Type 21/10/CD** thick base, reduced sample for CD.
- Cell compartment spacers **SPA** available for 1, 2 & 5mm Path length cells (see page 28).

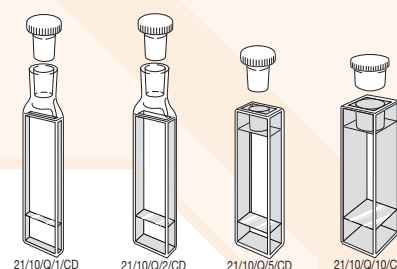
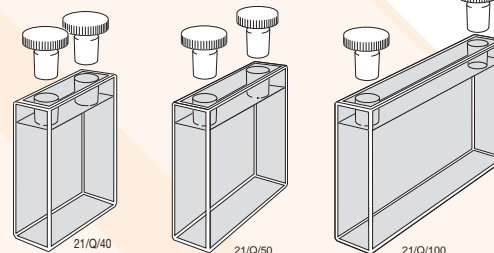
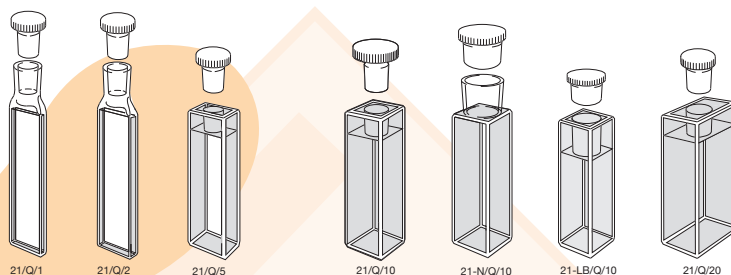

Type No.	Window Materials	Path Length	Internal Width	External			Nominal Vol. ml
				L	W	H	
21	G, SOG, Q, I, SX	1	10	3.5	12.5	55	0.400
21	G, SOG, Q, I, SX	2	10	4.5	12.5	55	0.700
21	G, SOG, Q, I, SX	5	10	7.5	12.5	48	1.700
21	G, SOG, HH, Q, I, SX	10	10	12.5	12.5	48	3.500
21	G, SOG, Q, I, SX	20	10	22.5	12.5	48	7.000
21	G, SOG, Q, I, SX	30	10	32.5	12.5	48	10.500
21	G, SOG, Q, I, SX	40	10	42.5	12.5	48	14.000
21	G, SOG, Q, I, SX	50	9.5	52.5	12.5	48	17.500
21	G, SOG, Q, I, SX	100	9.5	102.5	12.5	48	35.000
21-N	Q	10	10	12.5	12.5	43	3.000
21-LB	Q	10	10	12.5	12.5	42	3.000
<hr/>							
21/10/CD	Q, I	1	10	3.5	12.5	55	0.275
21/10/CD	Q, I	2	10	4.5	12.5	55	0.450
21/10/CD	Q, I	5	10	7.5	12.5	48	1.200
21/10/CD	Q, I	10	10	12.5	12.5	48	2.500

G = Optical Glass 334-2500nm SOG = Special Optical Glass 320-2500nm PX = Borosilicate 325-2500nm HH = UV Silica 220-2500nm
Q = Far UV Quartz 170-2700nm I = Near Infra-Red Quartz 220-3800nm SX = Far UV to Near IR Quartz (Water free) 170-3500nm

standard rectangular with lid and with stopper

Type 8. Semi Micro short

- Open top, supplied with non-sealing PTFE cover.
- Two polished windows.
- Walls polished internally, fine ground externally.

Type No.	Window Materials	Path Length	Internal Width	External L	External W	External H	Base Thickness	Nominal Vol. ml
Clear walls								
8	SOG, Q	5	4	7.5	12.5	25	3	0.400
8	SOG, Q	10	4	12.5	12.5	25	3	0.800
Self-masking. Black walls								
8/B	SOG, Q	5	4	7.5	12.5	25	3	0.400
8/B	SOG, Q	10	4	12.5	12.5	25	3	0.800

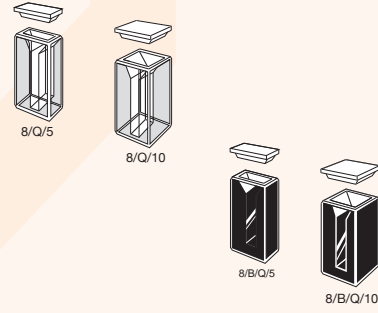

Type 9 & 9/B. Semi-micro with lid

- Reduced nominal volume to <50% of Standard rectangular.
- Open top, supplied with non-sealing PTFE cover.
- Two polished windows.
- Walls polished internally, fine ground externally.
- Suitable for use with all standard cell holders.
- **Self-masking solid black walls** enhance sensitivity and improve linearity at higher absorbances.

Type No.	Window Materials	Path Length	Internal Width	External L	External W	External H	Base Thickness	Nominal Vol. ml
Clear walls								
9	G, SOG, Q, I, SX	5	4	7.5	12.5	45	3	0.700
9	G, SOG, PX, HH, Q, I, SX	10	4	12.5	12.5	45	3	1.400
9	SOG, Q, I, SX	20	4	22.5	12.5	45	3	2.800
9	SOG, Q, I, SX	40	4	42.5	12.5	45	3	5.600
9	SOG, Q, I, SX	50	4	52.5	12.5	45	3	7.000
9	Q, I, SX	100	4	102.5	12.5	45	3	14.000
9/9	SOG, Q, I, SX	10	4	12.5	12.5	45	9	1.160
Self-masking. Black walls								
9/B	SOG, Q, I, SX	5	4	7.5	12.5	45	3	0.700
9/B	SOG, HH, Q, I, SX	10	4	12.5	12.5	45	3	1.400
9/B	SOG, Q, I, SX	20	4	22.5	12.5	45	3	2.800
9/B	SOG, Q, I, SX	40	4	42.5	12.5	45	3	5.600
9/B	SOG, Q, I, SX	50	4	52.5	12.5	45	3	7.000
9/B/9	SOG, Q, I, SX	10	4	12.5	12.5	45	9	1.160

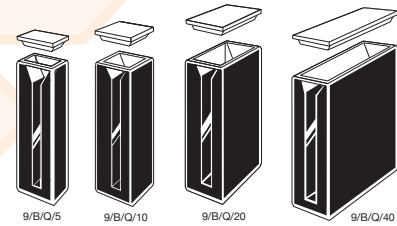
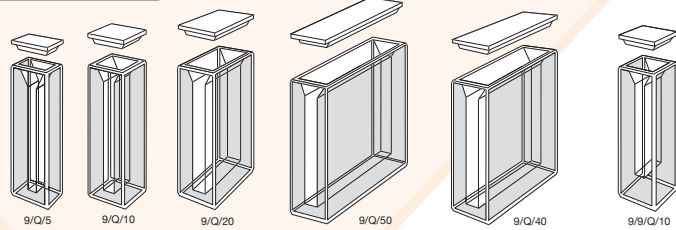

Type 29 & 29/B. Semi-micro with stopper(s)

- Reduced nominal volume to <50% of Standard rectangular.
- Closed by PTFE stopper(s), providing a liquid-tight seal.
- Two polished windows.
- Walls polished internally, fine ground externally.
- Suitable for use with all standard cell holders.
- **Self-masking solid black walls** enhance sensitivity and improve linearity at higher absorbances.

Type No.	Window Materials	Path Length	Internal Width	External L	External W	External H	Base Thickness	Nominal Vol. ml
Clear walls								
29	SOG, Q, I, SX	5	4	7.5	12.5	48	3	0.700
29	SOG, PX, HH, Q, I, SX	10	4	12.5	12.5	48	3	1.400
29	SOG, Q, I, SX	20	4	22.5	12.5	48	3	2.800
29	SOG, Q, I, SX	40	4	42.5	12.5	48	3	5.600
29	SOG, Q, I, SX	50	4	52.5	12.5	48	3	7.000
29/9	SOG, Q, I, SX	10	4	12.5	12.5	48	9	1.160
Self-masking. Black walls								
29/B	SOG, Q, I, SX	5	4	7.5	12.5	48	3	0.700
29/B	SOG, HH, Q, I, SX	10	4	12.5	12.5	48	3	1.400
29/B	SOG, Q, I, SX	20	4	22.5	12.5	48	3	2.800
29/B	SOG, Q, I, SX	40	4	42.5	12.5	48	3	5.600
29/B	Q, I, SX	50	4	52.5	12.5	48	3	7.000
29/B/9	SOG, Q, I, SX	10	4	12.5	12.5	48	9	1.160
29/B/12	Q	1	4	12.5	12.5	48	12	0.100
29/B/12	Q	2	4	12.5	12.5	48	12	0.200
29/B/12	Q	5	4	12.5	12.5	48	12	0.500
29/B/12	Q	10	4	12.5	12.5	48	12	1.000

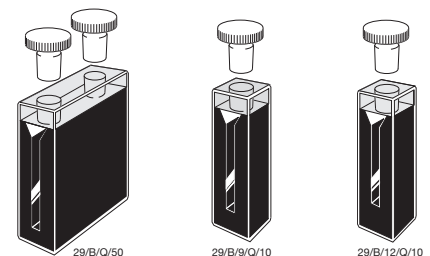
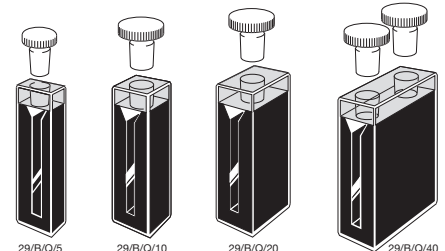
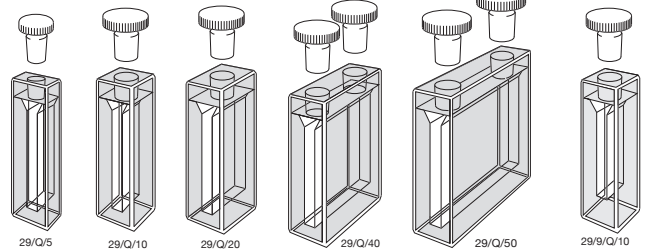

Type 17. Micro short

- Two polished windows.
- Open top, supplied with non-sealing PTFE cover.
- Walls polished internally, fine ground externally.
- Base thickness - 3mm.

Type No.	Window Materials	Path Length	Internal Width	External L	External W	External H	Nominal Vol. ml
Clear walls							
17	SOG, Q	5	2	7.5	12.5	25	0.200
17	SOG, Q	10	2	12.5	12.5	25	0.400
Self-masking. Black walls							
17/B	SOG, Q	5	2	7.5	12.5	25	0.200
17/B	SOG, Q	10	2	12.5	12.5	25	0.400

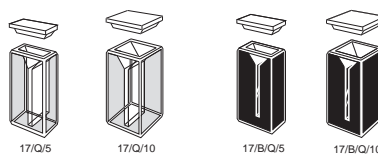

Type 18 & 18/B. Micro with lid

- Reduced nominal volume to <20% of Standard rectangular.
- Open top, with non-sealing PTFE cover.
- Two polished windows.
- Walls polished internally, fine ground externally.
- Suitable for use with all standard cell holders.
- **Self-masking solid black walls** enhance sensitivity and improve linearity at higher absorbances.

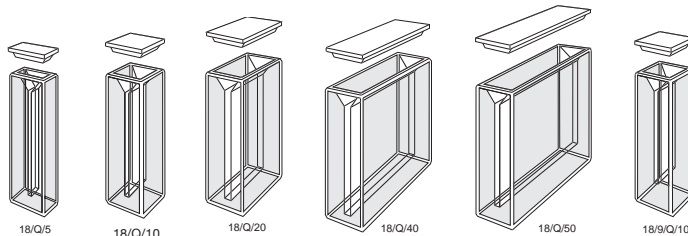

Type No.	Window Materials	Path Length	Internal Width	External L	External W	External H	Base Thickness	Nominal Vol. ml
Clear walls								
18	SOG, Q, I, SX	5	2	7.5	12.5	45	3	0.350
18	SOG, PX, HH, Q, I, SX	10	2	12.5	12.5	45	3	0.700
18	SOG, Q, I, SX	20	2	22.5	12.5	45	3	1.400
18	SOG, Q, I, SX	40	2	42.5	12.5	45	3	2.800
18	SOG, Q, I, SX	50	2	52.5	12.5	45	3	3.500
18	SOG, Q, I, SX	50	2	52.5	12.5	45	3	3.500
18	Q, I, SX	100	2	102.5	12.5	45	3	7.000
18/9	SOG, Q, I, SX	10	2	12.5	12.5	45	9	0.580
Self-masking. Black walls								
18/B	SOG, Q, I, SX	5	2	7.5	12.5	45	3	0.350
18/B	SOG, HH, Q, I, SX	10	2	12.5	12.5	45	3	0.700
18/B	SOG, Q, I, SX	20	2	22.5	12.5	45	3	1.400
18/B	SOG, Q, I, SX	40	2	42.5	12.5	45	3	2.800
18/B	SOG, Q, I, SX	50	2	52.5	12.5	45	3	3.500
18/B/9	SOG, Q, I, SX	10	2	12.5	12.5	45	9	0.580

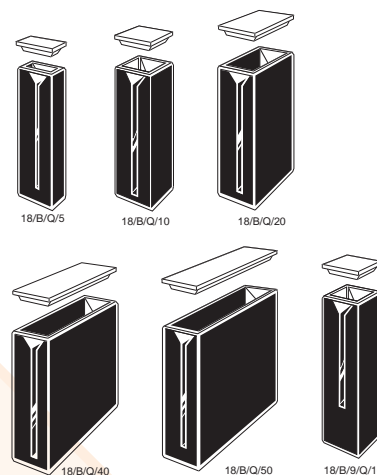

Type 28 & 28/B. Micro with stopper(s)

- Reduced nominal volume to <20% of Standard rectangular.
- Closed by PTFE stopper(s), providing a liquid-tight seal.
- Two polished windows.
- Walls polished internally, fine ground externally.
- Suitable for use with all standard cell holders.
- **Self-masking solid black walls** enhance sensitivity and improve linearity at higher absorbances.

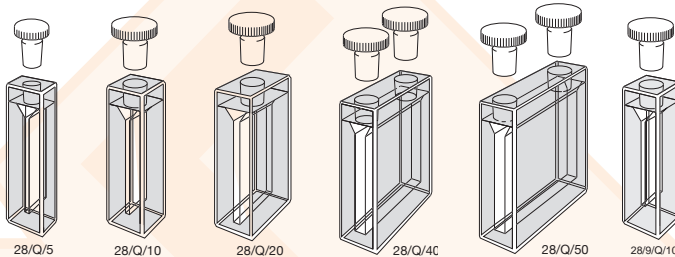

Type No.	Window Materials	Path Length	Internal Width	External L	External W	External H	Base Thickness	Nominal Vol. ml
Clear walls								
28	SOG, Q, I, SX	5	2	7.5	12.5	48	3	0.350
28	SOG, PX, HH, Q, I, SX	10	2	12.5	12.5	48	3	0.700
28	SOG, Q, I, SX	20	2	22.5	12.5	48	3	1.400
28	SOG, Q, I, SX	40	2	42.5	12.5	48	3	2.800
28	SOG, Q, I, SX	50	2	52.5	12.5	48	3	3.500
28/9	SOG, Q, I, SX	10	2	12.5	12.5	48	9	0.580
Self-masking. Black walls								
28/B	SOG, Q, I, SX	5	2	7.5	12.5	48	3	0.350
28/B	SOG, HH, Q, I, SX	10	2	12.5	12.5	48	3	0.700
28/B	SOG, Q, I, SX	20	2	22.5	12.5	48	3	1.400
28/B	SOG, Q, I, SX	40	2	42.5	12.5	48	3	2.800
28/B	Q, I, SX	50	2	52.5	12.5	48	3	3.500
28/B/9	SOG, Q, I, SX	10	2	12.5	12.5	48	9	0.580

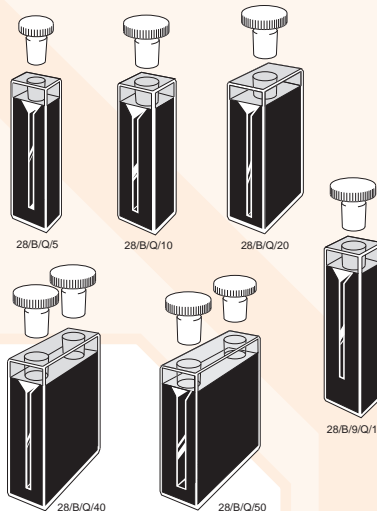

Type 15. Sub-micro & Multi-micro, short

- Two polished windows.
- Open top.
- To be used with holder supplied by instrument manufacturer.

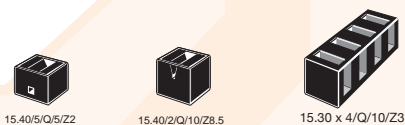

Type No.	Window Material	Path Length	Z Height	Internal W	Internal H	External L	External W	External H	Nominal Vol. ml	Remarks
15.40/5	Q	10	2	2	5	12.5	12.5	8	0.100	Cecil
15.40/4	Q	10	2	2	4	12.5	12.5	10	0.050	Biochrom® (masked 2x2)
15.40/7.5	Q	10	2	2	7.5	12.5	12.5	10	0.160	Shimadzu®
15.40/2	Q	10	8.5	2	2	12.5	12.5	12	0.040	Beckman®
15.30x4	Q	10	3	3	10	36	36	14.5	0.300	Beckman®

Type 16 & 16R. Sub-micro

- Sub-micro volumes from 10µl to 160µl.
- **Type 16** has a top section; comprising two black walls and two translucent side walls with a square internal cross-section.
- Open top, supplied with non-sealing PTFE cover as well as a vanned lid to provide a liquid-tight seal.
- To avoid possible meniscus errors; it may be necessary to increase the nominal sample fill volume by at least 20%.
- Z dimension measurement or instrument information is required when ordering.
- May be used with all standard cell holders.
- Filling and emptying with a pipette is recommended.

- **Type 16R.** Similar to **Type 16** except that the top section is solid black quartz and round internal cross-section.
- Closed by a vanned polyethylene plug stopper to provide a liquid-tight seal.

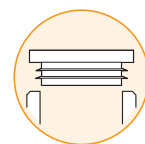
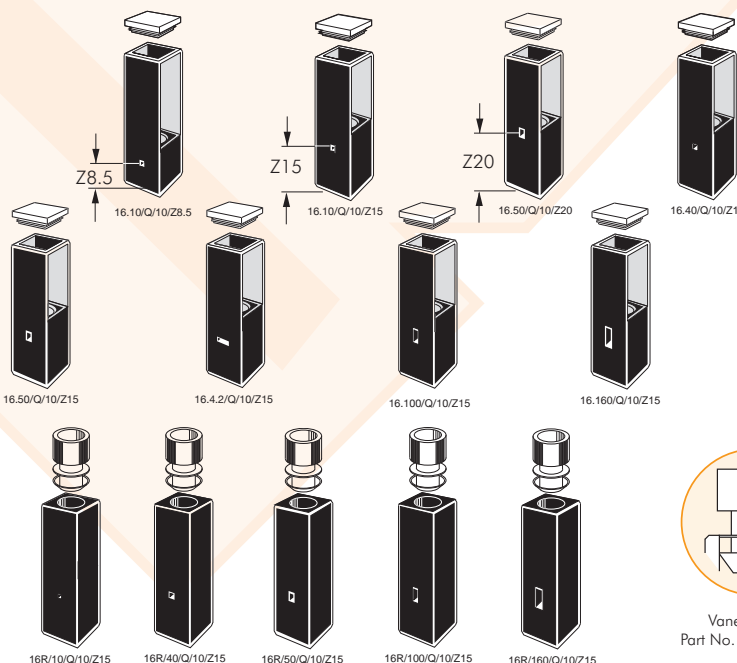

Vanned polyethylene lid
Part No. Lid/1.010V

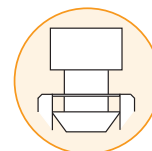

Vanned stopper
Part No. STP/C10.10V

Type No.	Window Material	Path Length	Z Height	Internal W	Internal H	External L	External W	External H	Nominal Vol. ml
Square top, two translucent walls									
16.10	Q	10	8.5, 15, 20	1	1	12.5	12.5	45	0.010
16.40	Q	10	8.5, 15, 20	2	2	12.5	12.5	45	0.040
16.50	Q	10	8.5, 15, 20	2	2.5	12.5	12.5	45	0.050
16.4.2	Q	10	15	4	2	12.5	12.5	45	0.080
16.100	Q	10	8.5, 15, 20	2	5	12.5	12.5	45	0.100
16.160	Q	10	8.5, 15, 20	2	8	12.5	12.5	45	0.160
Square top with round hole, solid black									
16R/10	Q	10	8.5, 15, 20	1	1	12.5	12.5	45	0.010
16R/40	Q	10	8.5, 15, 20	2	2	12.5	12.5	45	0.040
16R/50	Q	10	8.5, 15, 20	2	2.5	12.5	12.5	45	0.050
16R/100	Q	10	8.5, 15, 20	2	5	12.5	12.5	45	0.100
16R/160	Q	10	8.5, 15, 20	2	8	12.5	12.5	45	0.160

Z Dimension per instrument

Manufacturer	Z Dimension
Agilent®	15mm
Beckman®	8.5mm
Bio-Rad®	8.5mm
Eppendorf®	8.5mm
GBC®	15mm
Hewlett Packford®	15mm
Hitachi®	8.5mm
Jasco®	12mm
Perkin-Elmer®	15mm
Pharmacia®	15mm
Scinco®	15mm
Shimadzu®	15mm
Spectronics®	8.5mm
Turner®	8.5mm
Varian® (Cary®/Agilent®)	20mm

Type 26. Sub-micro & Ultra-micro with stopper

- Reduced nominal volume from 10 μ l to 160 μ l.
- Rectangular top section with two black walls and two translucent walls.
- Closed by PTFE stopper, providing a liquid-tight seal.
- To avoid possible meniscus errors; it may be necessary to increase the nominal sample fill volume by at least 20%.
- May also be used with all standard cell holders.
- Z dimension or instrument information required when ordering.
- Filling and emptying with a pipette is recommended.

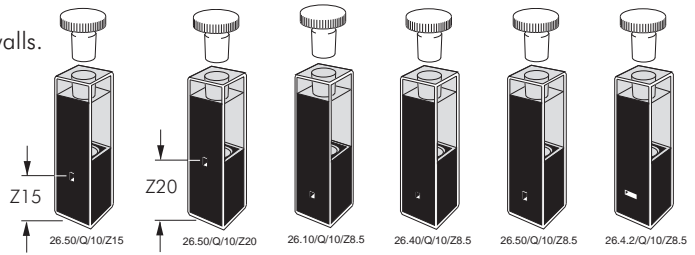

Type No.	Window Material	Path Length	Z Height	Internal W	Internal H	External L	External W	External H	Nominal Vol. ml
26.10	Q	10	8.5, 15, 20	1	1	12.5	12.5	48	0.010
26.40	Q	10	8.5, 15, 20	2	2	12.5	12.5	48	0.040
26.4.2	Q	10	15, 20	4	2	12.5	12.5	48	0.080
26.50	Q	10	8.5, 15, 20	2	2.5	12.5	12.5	48	0.050
26.100	Q	10	8.5, 15, 20	2	5	12.5	12.5	48	0.100
26.160	Q	10	8.5, 15, 20	2	8	12.5	12.5	48	0.160

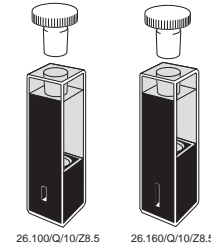

Type 26/LHS. Sub-micro, low head space

- The cell and liquid-tight stopper are specially designed so the volume of air above the sample is reduced by >95% compared with normal sub-micro cells.
- This reduces evaporation loss of samples such as DNA to a minimum.
- Reduced nominal volume range from 10 μ l to 440 μ l.
- Round internal solid black top closed by a specially profiled PTFE stopper. Spare stoppers, **see page 28**.
- Part No. STP/C10.LHS/Z8.5 or STP/C10.LHS/Z15/20
- Quartz stoppers available to avoid condensation errors at higher temperatures (see page 28)
- To avoid possible meniscus errors; it may be necessary to increase the nominal sample fill volume by at least 20%.
- Sample may be introduced and retrieved by syringe or micro pipette.
- Z dimension or instrument information required when ordering.

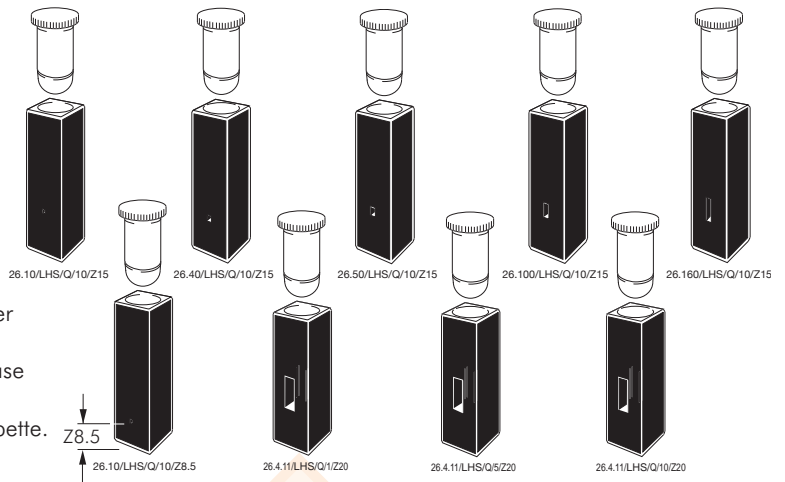

Type No.	Window Material	Path Length	Z Height	Internal W	Internal H	External L	External W	External H	Nominal Vol. ml
26.10/LHS	Q	10	8.5, 15, 20	1	1	12.5	12.5	48	0.010
26.40/LHS	Q	10	8.5, 15, 20	2	2	12.5	12.5	48	0.040
26.50/LHS	Q	10	8.5, 15, 20	2	2.5	12.5	12.5	48	0.050
26.100/LHS	Q	10	8.5, 15, 20	2	5	12.5	12.5	48	0.100
26.160/LHS	Q	10	8.5, 15, 20	2	8	12.5	12.5	48	0.160
26.4.11/LHS	Q	1	20	4	11	12.5	12.5	48	0.044
26.4.11/LHS	Q	5	20	4	11	12.5	12.5	48	0.220
26.4.11/LHS	Q	10	20	4	11	12.5	12.5	48	0.440

Z Dimension per instrument

Manufacturer	Z Dimension
Agilent®	15mm
Beckman®	8.5mm
Bio-Rad®	8.5mm
Eppendorf®	8.5mm
GBC®	15mm
Hewlett Packford®	15mm
Hitachi®	8.5mm
Jasco®	12mm
Perkin-Elmer®	15mm
Pharmacia®	15mm
Scinco®	15mm
Shimadzu®	15mm
Spectronics®	8.5mm
Turner®	8.5mm
Varian® (Cary®/Agilent®)	20mm

Type 19 Ultra-micro & 19/L Ultra-micro lens cell

- Ultra-micro volume range from 0.5 μ l to 10 μ l.
- Two polished windows.
- Sample inserted and retrieved with micro pipette tip.
- Two micro pipette tips provided with each cell.
- **Type 19/L** is a patented design with integral focusing lens. Which increases the energy entering the sample. Performance is dictated by instrument optical configuration.
- **Type 19/L** is not suitable for all instruments.
- **Type 19/L Z 8.5*** has an External height of 38.5mm
- **Z dimension or instrument information required when ordering.**

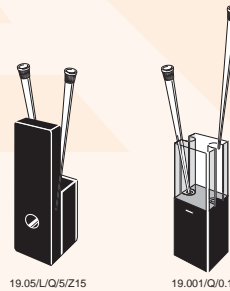

Type No.	Window Material	Path Length	Z Height	Internal W	Internal H	External L	External W	External H	Nominal Vol. ml
19.001	Q	0.1	8.5, 15, 20	5	1	12.5	12.5	45	0.0005
19.01	Q	1	8.5, 15, 20	5	1	12.5	12.5	45	0.0050
19.05	Q	5	8.5, 15, 20	0.8 \emptyset		12.5	12.5	45	0.0025
19.10	Q	10	8.5, 15, 20	0.8 \emptyset		12.5	12.5	45	0.0050
19.05/L	Q	5	8.5*, 15, 20	1	1	12.5	12.5	45	0.0050

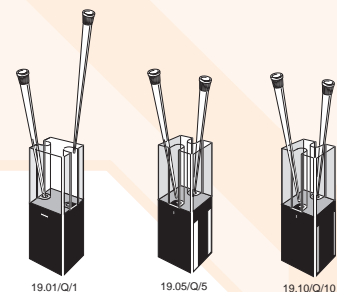

Type 31. Cylindrical. Short path length

- Two polished windows.
- Closed by PTFE stopper, providing a liquid-tight seal.

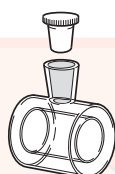

31/Q/1

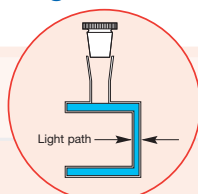

Type 31/B. Cylindrical. Short path length, micro.

- Reduced sample volume.
- Two polished windows.
- Two filling ports, closed by two PTFE stoppers, providing a liquid-tight seal.



31/B/Q/1

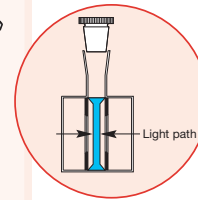

Type No.	Window Materials	Path Length	Internal Dia.	External Dia.	L	Nominal Vol. ml
31	Q, I, SX	0.01	15	22	22.5	2.15
31	Q, I, SX	0.05	15	22	22.5	2.15
31	Q, I, SX	0.10	15	22	22.5	2.15
31	Q, I, SX	0.20	15	22	22.5	2.18
31	Q, I, SX	0.50	15	22	22.5	2.22
31	Q, I, SX	1	15	22	22.5	2.31
31	Q, I, SX	2	15	22	22.5	2.49
31	Q, I, SX	5	15	22	22.5	3.02

Type No.	Window Materials	Path Length	Internal Dia.	External Dia.	L	Nominal Vol. ml
31/B	Q	0.01	13	22	22.5	0.140
31/B	Q	0.05	13	22	22.5	0.151
31/B	Q	0.10	13	22	22.5	0.165
31/B	Q	0.20	13	22	22.5	0.194
31/B	Q	0.50	13	22	22.5	0.278
31/B	Q	1	13	22	22.5	0.420
31/B	Q	2	13	22	22.5	0.703
31/B	Q	5	13	22	22.5	1.552

Type 32. Cylindrical. Standard

- Two polished windows.
- Closed by a single PTFE stopper, providing a liquid-tight seal.



32/Q/1



32/Q/5

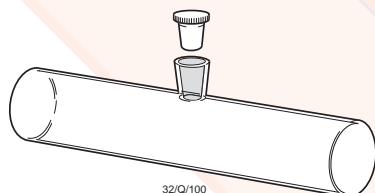

32/Q/100

Type No.	Window Materials	Path Length	Internal Dia.	External Dia.	L	Nominal Vol. ml
32	SOG, PX, Q, I, SX	1	19	22	3.5	0.28
32	SOG, PX, Q, I, SX	2	19	22	4.5	0.56
32	SOG, PX, Q, I, SX	5	19	22	7.5	1.40
32	SOG, PX, Q, I, SX	10	19	22	12.5	2.80
32	SOG, PX, Q, I, SX	20	19	22	22.5	5.60
32	SOG, PX, Q, I, SX	50	19	22	52.5	14.10
32	SOG, PX, Q, I, SX	100	19	22	102.5	28.20

Type 34. Cylindrical. Standard

- Two polished windows.
- Closed by two PTFE stoppers, providing a liquid-tight seal.

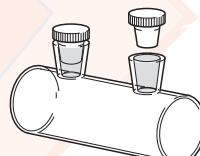

34/Q/50

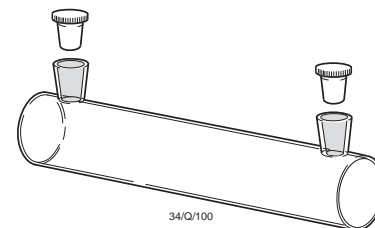

34/Q/100

Type No.	Window Materials	Path Length	Internal Dia.	External Dia.	L	Nominal Vol. ml
34.4	Q	100	4	6	102.5	1.30
34.8	Q	100	8	10	102.5	5.10
34.10	Q	100	10	12	102.5	7.86
34.12	Q	100	12	14	102.5	11.35
34	SOG, PX, Q, I, SX	50	19	22	52.5	14.10
34	SOG, PX, Q, I, SX	100	19	22	102.5	28.20
34	Q	200	19	22	202.5	56.40

Type 35. Cylindrical. Large diameter

- Two polished windows.
- Closed by PTFE stopper(s), providing a liquid-tight seal.



35/Q/5

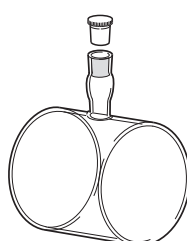

35/Q/50

Type No.	Window Materials	Path Length	Internal Dia.	External Dia.	L	Nominal Vol. ml
35	SOG, PX, Q, I	2	47	50	4.5	3.40
35	SOG, PX, Q, I	5	47	50	7.5	8.50
35	SOG, PX, Q, I	10	47	50	12.5	17.00
35	SOG, PX, Q, I	20	47	50	22.5	35.00
35	SOG, PX, Q, I	50	47	50	52.5	86.00
35	Q	100	47	50	102.5	172.00

Type 37. Cylindrical with tube

- Two polished windows.
- Tube material the same as cell body.
- Available on request with restriction for easy seal.

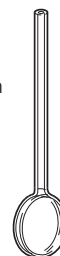

37/Q/1

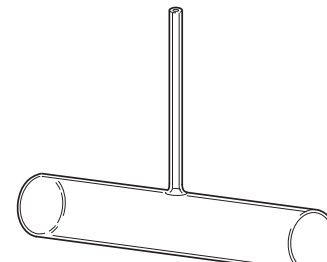

37/Q/100

Type No.	Window Materials	Path Length	Int. Dia.	Ext. Dia.	Tube L	Tube ID. OD.	Nominal Vol. ml
37	SOG, PX, Q, I, SX	1	19	22	3.5	2 4 70	0.28
37	SOG, PX, Q, I, SX	2	19	22	4.5	2 4 70	0.56
37	SOG, PX, Q, I, SX	5	19	22	7.5	2 4 70	1.40
37	SOG, PX, Q, I, SX	10	19	22	12.5	2 4 70	2.80
37	SOG, PX, Q, I, SX	20	19	22	22.5	2 4 70	5.60
37	SOG, PX, Q, I, SX	50	19	22	52.5	2 4 70	14.10
37	SOG, PX, Q, I, SX	100	19	22	102.5	2 4 70	28.20

Rectangular & Cylindrical with Quartz to Pyrex graded seal (GS)

- Quartz to pyrex graded seal fully fused to cell.
- Different diameters and lengths of graded seals can be supplied on request.

Rectangular & Cylindrical with straight tube (SBT)

- Quartz tube fully fused to quartz cell.
- Pyrex tube fully fused to pyrex cell
- Different diameters & lengths of straight bore tube can be supplied on request.

Rectangular for Low Temperature (HLT/GS) with Quartz to Pyrex graded seal

- 2mm thick walls.
- Fully fused 'welded' joints.
- Quartz to pyrex graded seal

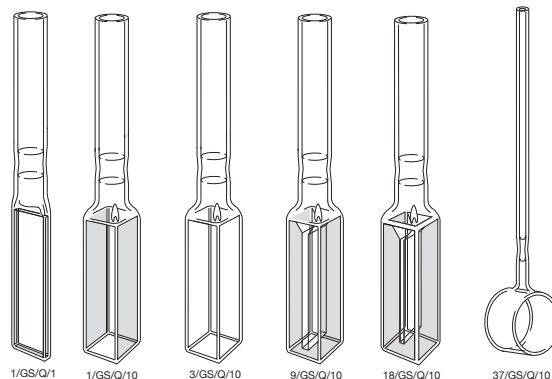

Type No.	Window Materials	Path Length	Internal Width	Internal Dia.	External				Tube			Nominal Vol. ml	Remarks
					L	W	H	D	ID.	OD.	L		
1/GS or SBT	Q, I	1	10		3.5	12.5	115		8	10	70	0.40	Macro/Standard rectangular
1/GS or SBT	Q, I	2	10		4.5	12.5	115		8	10	70	0.70	Macro/Standard rectangular
1/GS or SBT	Q, I	5	10		7.5	12.5	115		8	10	70	1.70	Macro/Standard rectangular
1/GS or SBT	Q, I	10	10		12.5	12.5	115		8	10	70	3.50	Macro/Standard rectangular
3/GS or SBT	Q, I	10	10		12.5	12.5	115		8	10	70	3.50	Fluorimeter
9/GS or SBT	Q, I	10			12.5	12.5	115		8	10	70	1.40	Semi-micro
18/GS or SBT	Q, I	10			12.5	12.5	115		8	10	70	0.70	Micro
37/GS	Q, I	1		19	3.5			22	2	4	70	0.28	Cylindrical
37/GS	Q, I	2		19	4.5			22	2	4	70	0.56	Cylindrical
37/GS	Q, I	5		19	7.5			22	2	4	70	1.40	Cylindrical
37/GS	Q, I	10		19	12.5			22	2	4	70	2.80	Cylindrical
37/GS	Q, I	20		19	22.5			22	2	4	70	5.60	Cylindrical
37/GS	Q, I	50		19	52.5			22	2	4	70	14.00	Cylindrical
37/GS	Q, I	100		19	102.5			22	2	4	70	28.00	Cylindrical
1/HLT/GS	Q	10	8.5	10	12.5		115		8	10	70	3.5	Macro/Standard rectangular
3/HLT/GS	Q	10	8.5	10	12.5		115		8	10	70	3.5	Fluorimeter

Type 700. UHV Stopcock cells

- High vacuum patented stopcock.
- All cells will withstand evacuation $< 10^{-11}$ Tor.
- PTFE threaded.
- Can be fused to most quartz cells.
- Stopcock itself can withstand pressure up to 5 bar (5×10^5 Pa).
- For cell pressure guidance; please enquire.

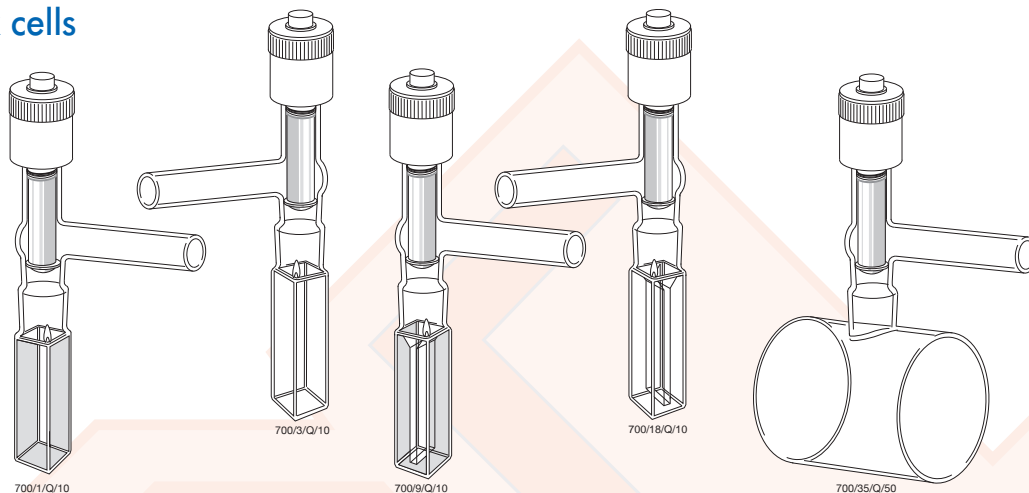

Type No.	Window Material	Path Length	External			Side arm			Remarks
			L	W	H	ID.	OD.	Length	
700/1	Q	10	12.5	12.5	≈135/150	10	13	50	Type 1 Macro
700/3	Q	10	12.5	12.5	≈135/150	10	13	50	Type 3 Fluorimeter
700/9	Q	10	12.5	12.5	≈135/150	10	13	50	Type 9 Semi micro
700/18	Q	10	12.5	12.5	≈135/150	10	13	50	Type 18 Micro
700/32	Q	10	22.5	22Ø	≈135/150	10	13	50	Type 32 Cylindrical
700/32	Q	20	22.5	22Ø	≈135/150	10	13	50	Type 32 Cylindrical
700/32	Q	40	42.5	22Ø	≈135/150	10	13	50	Type 32 Cylindrical
700/32	Q	50	52.5	22Ø	≈135/150	10	13	50	Type 32 Cylindrical
700/32	Q	100	102.5	22Ø	≈135/150	10	13	50	Type 32 Cylindrical
700/35	Q	50	52.5	50Ø	≈135/150	10	13	50	Type 35 Cylindrical
700/35	Q	100	102.5	50Ø	≈135/150	10	13	50	Type 35 Cylindrical

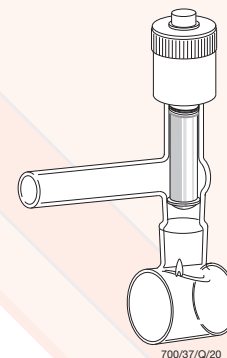

Rectangular Anaerobic with screw cap (GL14)

- Closed by screw cap or septum cap.
- **GL14/C** closed cap.
- **GL14/S** septum cap to allow filling, extraction or gas flow with syringe needle(s) through the silicone seal.
- Septum aperture diameter 9mm.
- Cap withstands pressure up to 5×10^5 Pa (5 bar).
- **GL14** can be fused to most rectangular and cylindrical cells with either one or two ports. Particularly suitable for stopping evaporation in cells used for stirring eg. **9/MS/GL14/Q/10**.

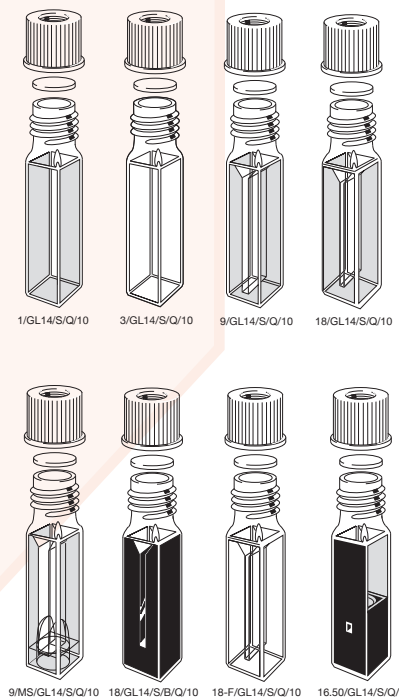
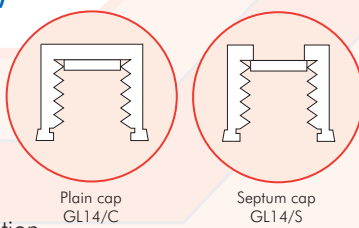

Type No.	Window Materials	Path Length	Internal Width	External L W H	Nominal Vol. ml	Remarks
1/GL14	SOG, Q, I	1	10	3.5 12.5 66	0.400	Macro/Rectangular
1/GL14	SOG, Q, I	2	10	4.5 12.5 66	0.800	Macro/Rectangular
1/GL14	SOG, Q, I	5	10	7.5 12.5 66	1.600	Macro/Rectangular
1/GL14	SOG, Q, I	10	10	12.5 12.5 66	3.500	Macro/Rectangular
9/GL14	SOG, Q, I	10	4	12.5 12.5 66	1.400	Semi-micro
9/B/GL14	Q, I	10	4	12.5 12.5 66	1.400	Semi-micro. Self masking
18/GL14	SOG, Q, I	10	2	12.5 12.5 66	0.700	Micro
18/B/GL14	Q, I	10	2	12.5 12.5 66	0.700	Micro. Self masking
3/GL14	SOG, Q, I	10	10	12.5 12.5 66	3.500	Fluorimeter
9-F/GL14	Q	10	10	12.5 12.5 66	1.400	Semi-micro. Fluorescent
18-F/GL14	Q	10	10	12.5 12.5 66	0.700	Micro. Fluorescent
16.**/GL14	Q	10	10	12.5 12.5 66	**all volumes	Sub-micro.
16.**-F/GL14	Q	10	10	12.5 12.5 66	**all volumes	Sub-micro.

Cylindrical Anaerobic with screw cap(s) (GL14)

- **GL14** can be fused to most cylindrical cells with either one or two ports.

Type No.	Window Materials	Path Length	External Length	Internal Diameter	Nominal Vol. ml
32/GL14	SOG, PX, Q, I, SX	10	12.5	19	2.800
32/GL14	SOG, PX, Q, I, SX	20	22.5	19	5.600
32/GL14	SOG, PX, Q, I, SX	50	52.5	19	14.100
32/GL14	SOG, PX, Q, I, SX	100	102.5	19	28.200
34/GL14	SOG, PX, Q, I	50	52.5	19	14.100
34/GL14	SOG, PX, Q, I	100	102.5	19	28.200

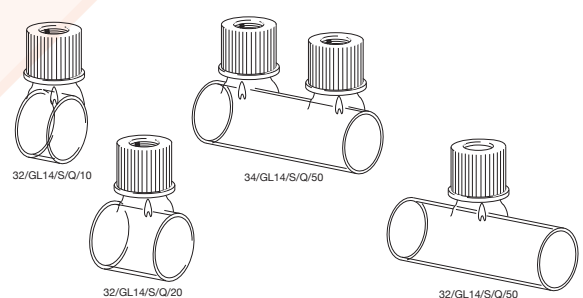

Rectangular Anaerobic for use with rubber septa seal

- **SBT10.15** tops suitable for rubber septa seal for Anaerobic environments. Tubing 15mm long, 10mm I.D.

Type No.	Window Materials	Path Length	Internal Width	External L W H	Tube D. OD. L	Nominal Vol. ml	Remarks
1/SBT10.15	Q, I	10	10	12.5 12.5 59	10 13 15	3.500	Macro/Standard rectangular
3/SBT10.15	Q, I	10	10	12.5 12.5 59	10 13 15	3.500	Fluorimeter
9/SBT10.15	Q, I	10	4	12.5 12.5 59	10 13 15	1.400	Semi-micro
18/SBT10.15	Q, I	10	2	12.5 12.5 59	10 13 15	0.700	Micro

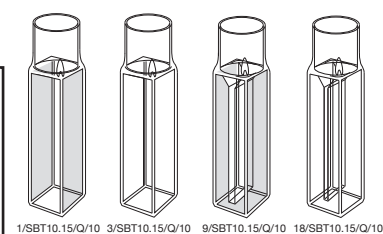

Rectangular with small screw cap (ST)

- Closed with screw cap, with or without septum aperture.
- Outside diameter of cap is less than the cross-section of the cell.
- Septum aperture diameter - 6mm.
- **ST/C** closed cap.
- **ST/S** septum cap to allow filling, extraction or gas flow with syringe needle(s) through silicone seal which has a PTFE face.

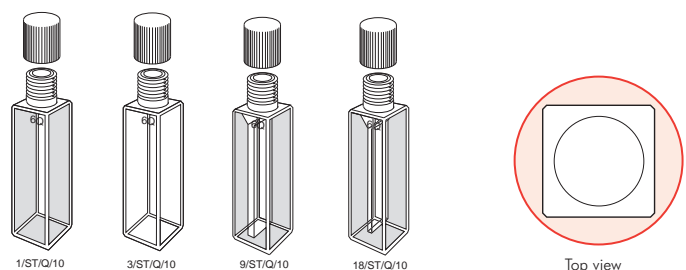

Type No.	Window Materials	Path Length	Internal Width	External L W H	Nominal Vol. ml	Remarks
1/ST	Q, I	10	10	12.5 12.5 58	3.500	Macro/Standard rectangular
1.30/ST	Q	10	10	12.5 12.5 43	2.800	For Reference Adaptor Plate
3/ST	Q, I	10	10	12.5 12.5 58	3.500	Fluorimeter
9/ST	Q, I	10	4	12.5 12.5 58	1.400	Semi-micro
18/ST	Q, I	10	2	12.5 12.5 58	0.700	Micro

Type 126 & 128. Anaerobic. Standard Rectangular 126-F & 128-F Fluorimeter

- Two polished windows except 126-F and 128-F have four windows and base polished.
- Reservoir has ground cone with evacuation hole to line up with socket outlet tube.
- Reservoir volume \approx .5ml.
- **Type 126** Evacuation tube is 3mm I.D., 5mm O.D. and 30mm long.
- **Type 128** Evacuation tube is 4mm I.D., 6mm O.D. and 30mm long.
- Socket assembly can be fused to other rectangular cells on request.

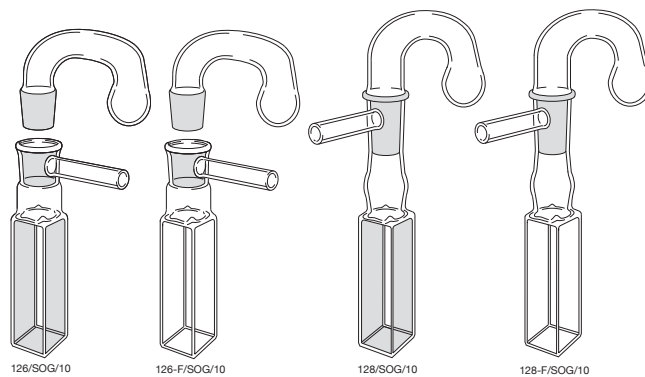

Type No.	Window Materials	Path Length	Internal Width		External			Nominal Vol. ml	Remarks
			W	H	L	W	H		
126 & 126-F	SOG, Q, I	2	2	4.5	12.5	70	0.700	Macro/Standard Rectangular. Short socket. Fluorimeter	
126 & 126-F	SOG, Q, I	5	5	7.5	12.5	70	1.750	Macro/Standard Rectangular. Short socket. Fluorimeter	
126 & 126-F	SOG, Q, I	10	10	12.5	12.5	70	3.500	Macro/Standard Rectangular. Short socket. Fluorimeter	
128 & 128-F	SOG, Q, I	2	2	4.5	12.5	120	0.700	Macro/Standard Rectangular. Extended socket. Fluorimeter	
128 & 128-F	SOG, Q, I	5	5	7.5	12.5	120	1.750	Macro/Standard Rectangular. Extended socket. Fluorimeter	
128 & 128-F	SOG, Q, I	10	10	12.5	12.5	120	3.500	Macro/Standard Rectangular. Extended socket. Fluorimeter	

Type 20/O. Short path length. Demountable, open-ended

- One end open when assembled.
- Two polished windows.
- Intended for use with Type CH/2049 cell holder. (see page 28)

Type No.	Window Materials	Path Length	Internal W	H	L	External W	H	Nominal Vol. ml
20/O	Q, I	0.01	10	43.5	2.5	12.5	45	0.004
20/O	Q, I	0.05	10	43.5	2.5	12.5	45	0.020
20/O	Q, I	0.1	10	43.5	2.6	12.5	45	0.040
20/O	Q, I	0.2	10	43.5	2.7	12.5	45	0.080
20/O	Q, I	0.5	10	43.5	3.0	12.5	45	0.190
20/O	G, SOG, Q, I	1	10	43.5	3.5	12.5	45	0.390

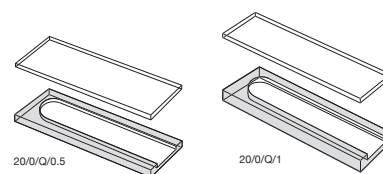

Type 20/C & Type 30. Short path length. Demountable, closed

- Totally enclosed when assembled.
- Two polished windows.
- **Type 20/C** intended for use with **Type CH/2049** cell holder. (see page 28)

Type No.	Window Materials	Path Length	Internal W	H	L	External W	H	O.D.	I.D.	Thickness	Nominal Vol. ml
20/C	Q	0.008	8	38	2.5	12.5	45				0.002
20/C	Q, I	0.01	8	38	2.5	12.5	45				0.003
20/C	Q, I	0.05	8	38	2.5	12.5	45				0.015
20/C	Q, I	0.1	8	38	2.6	12.5	45				0.030
20/C	Q, I	0.2	8	38	2.7	12.5	45				0.060
20/C	Q, I	0.5	8	38	3.0	12.5	45				0.150
20/C	G, SOG, Q, I	1	8	38	3.5	12.5	45				0.310
30	Q	0.01						22	16	2.5	0.002
30	Q	0.1						22	16	2.6	0.020
30	Q	0.2						22	16	2.7	0.040
30	Q	0.5						22	16	3.0	0.100

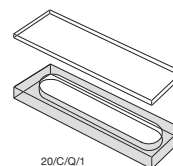

Type 45 & 45-F. Flow cells. In-line or microscope analysis

- **Type 45** two polished windows. **Type 45-F** has four polished windows.
- Tubes may be bent at angles to sample compartment if required.
- Up to 2mm Path length. Inlet/Outlet tubes - 2mm I.D., 4mm O.D. x 25mm long.
- Up to 5mm Path length. Inlet/Outlet tubes - 5mm I.D., 7mm O.D. x 25mm long.

Type No.	Window Material	Path Length	Internal Width	External L	W	H	Nominal Vol. ml
45 & 45-F	Q	0.1	10	2.6	12.5	40 + tubes	0.040
45 & 45-F	Q	0.2	10	2.7	12.5	40 + tubes	0.080
45 & 45-F	Q	0.5	10	3.0	12.5	40 + tubes	0.200
45 & 45-F	Q	1.0	10	3.5	12.5	40 + tubes	0.400
45 & 45-F	Q	2.0	10	4.5	12.5	40 + tubes	0.800
45 & 45-F	Q	5.0	10	7.5	12.5	40 + tubes	4.000

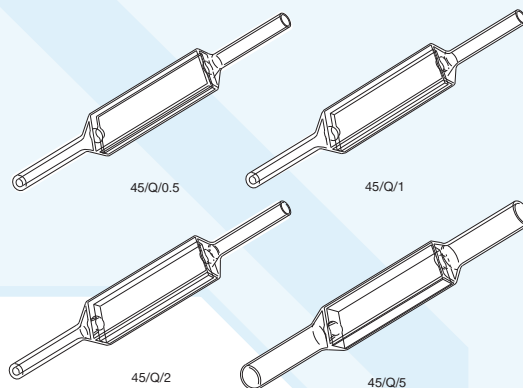

Type 46, 46-F Fluorimeter & 47 Flow cells. In-line

- Two polished windows. Type 46-F have 4 windows and base polished.
- Tubulations intended for push-on flexible tubing.
- Profiled inlet and outlet
- Inlet/outlet tubes - 2mm I.D., 4mm O.D. and 10mm long.
- TYPE 47/TC Screw-on connections

Type No.	Window Materials	Path Length	Internal Width	External L	External W	External H	Nominal Vol. ml
Clear walls							
46 & 46-F	Q	0.5	10	12.5	12.5	65	0.185
46 & 46-F	Q	1	10	12.5	12.5	65	0.370
46 & 46-F	Q	2	10	12.5	12.5	65	0.740
46 & 46-F	Q	5	10	12.5	12.5	65	1.850
46 & 46-F	G, SOG, Q	10	10	12.5	12.5	65	3.700
Semi-micro. Clear walls							
47	G, SOG, Q	10	4	12.5	12.5	65	1.480
47/TC	Q	10	4	12.5	12.5	65	1.480
Semi-micro. Self-masking. Black walls							
47/B	Q	10	4	12.5	12.5	65	1.480

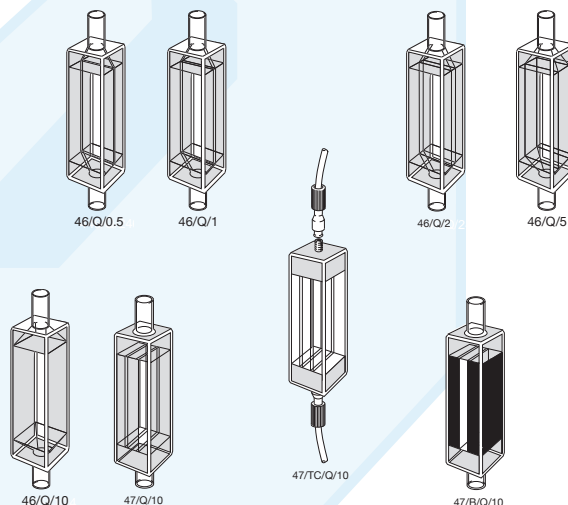

Type 48 Flow cells & Type 49 demountable Flow cells. Short path length

- Two polished windows.
- Inlet/outlet tubes - 2 I.D, 4 O.D, 16mm long intended for push-on flexible tubing.
- Intended for use with Type CH/2049 cell holder. (see page 28)

Type No.	Window Materials	Path Length	Internal W	Internal H	External L	External W	External H	Nominal Vol. ml
48 or 49	Q, I	0.01	8	38	2.6	12.5	45	0.003
48 or 49	Q, I	0.1	8	38	2.6	12.5	45	0.030
48 or 49	Q, I	0.2	8	38	2.7	12.5	45	0.060
48 or 49	Q, I	0.5	8	38	3.0	12.5	45	0.150
48 or 49	G, SOG, Q, I	1	8	38	3.5	12.5	45	0.300
48 or 49	G, SOG, Q, I	2	8	38	4.5	12.5	45	0.600
48 or 49	G, SOG, Q, I	5	8	38	7.5	12.5	45	1.560

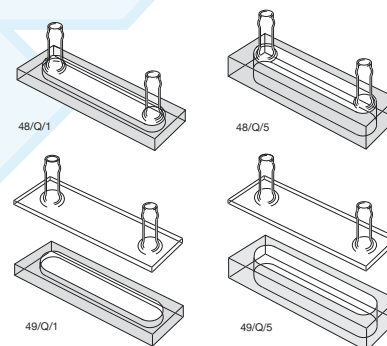

Type 48-4 Flow cells & Type 49-4 demountable Flow cells. Short path length

- Two polished windows.
- Inlet/outlet tubes - 2 I.D, 4 O.D, 16mm long intended for push-on flexible tubing.
- Intended for use with Type CH/2049 cell holder. (see page 28)

Type No.	Window Materials	Path Length	Internal W	Internal H	External L	External W	External H	Nominal Vol. ml
48-4 or 49-4	Q, I	0.01	4	38	2.6	12.5	45	0.002
48-4 or 49-4	Q, I	0.1	4	38	2.6	12.5	45	0.015
48-4 or 49-4	Q, I	0.2	4	38	2.7	12.5	45	0.030
48-4 or 49-4	Q, I	0.5	4	38	3.0	12.5	45	0.075
48-4 or 49-4	G, SOG, Q, I	1	4	38	3.5	12.5	45	0.150
48-4 or 49-4	G, SOG, Q, I	2	4	38	4.5	12.5	45	0.300
48-4 or 49-4	G, SOG, Q, I	5	4	38	7.5	12.5	45	0.780

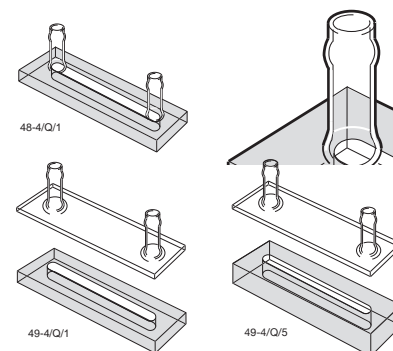

Types UTWA & UTWA2. Ultra thin wall aperture cells

- Two polished windows.
- Aperture window - 0.2mm (200 microns)
- For use with high magnification systems
- UTWA/2 has two thin window apertures, one in each window.

Type No.	Window Materials	Path Length	Internal Width	External L	External W	Internal HDia.	External Dia.
1/UTWA	Q	All	10	12.5	12.5	45	-
1/UTWA2	Q		10	12.5	12.5	45	-
45/UTWA	Q	Path	10	12.5	12.5	45	-
45/UTWA2	Q		10	12.5	12.5	45	-
48/UTWA	Q	Lengths	10	2.6	12.5	45	-
48/UTWA2	Q		10	2.6	12.5	45	-
32/UTWA	Q	-	-	22.5	-	-	15
32/UTWA2	Q	-	-	22.5	-	-	15

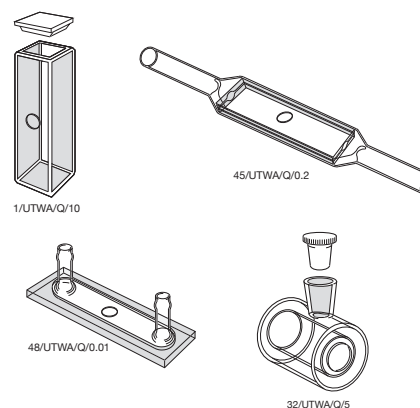

Type 71, 71B, 71F, 72, 72B & 72F Flow cells. Standard and semi-micro

- 71, 71B, 72 & 72B have two polished windows.
- Long sample compartment suitable for all Z dimensions.
- Inlet/outlet tubes - 2 I.D, 4 O.D, 16mm long intended for push-on flexible tubing.
- Also available with TC threaded connectors.
- 71-F & 72-F fluorescence cells have three polished windows.

Type No.	Window Materials	Path Length	Internal		External			Nominal Vol. ml
			W	H	L	W	H	
Clear walls								
71	Q	10	7	37.5	12.5	12.5	48	3.000
71-F	Q	10	7	37.5	12.5	12.5	48	3.000
72	Q	10	4	37.5	12.5	12.5	48	1.800
72-F	Q	10	4	37.5	12.5	12.5	48	1.800
Self masking. Black walls								
71/B	Q	1	7	37.5	12.5	12.5	48	0.300
71/B	Q	10	7	37.5	12.5	12.5	48	3.000
72/B	Q	1	4	37.5	12.5	12.5	48	0.180
72/B	Q	10	4	37.5	12.5	12.5	48	1.800

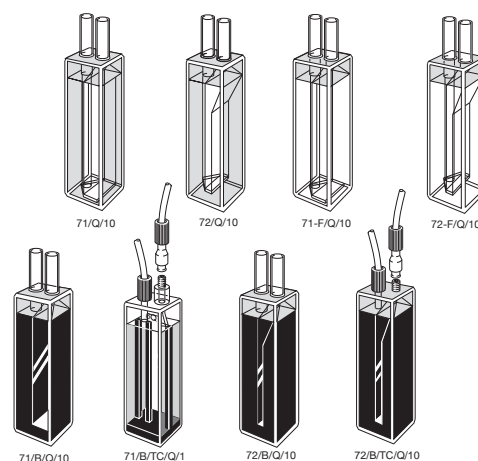

Type 73.4. Flow cells. Dissolution, medium aperture

- Two polished windows.
- Inlet/outlet tubes - 2 I.D, 4 O.D, 10mm long intended for push-on flexible tubing.
- Cells with a Z height of 8.5mm have an overall height of 38.5mm.

Type No.	Window Material	Path Length	Z Height	Internal		External			Nominal Vol. ml
				W	H	L	W	H	
73.4	Q	1	8.5, 15, 20	4	11	12.5	12.5	45	0.045
73.4	Q	2	8.5, 15, 20	4	11	12.5	12.5	45	0.090
73.4	Q	5	8.5, 15, 20	4	11	12.5	12.5	45	0.225
73.4	SOG, Q, SX	10	8.5, 15, 20	4	11	12.5	12.5	45	0.450
73.4	Q	20	8.5, 15, 20	4	11	22.5	12.5	45	0.900
73.4	Q	40	8.5, 15, 20	4	11	42.5	12.5	45	1.800
73.4	Q	50	8.5, 15, 20	4	11	52.5	12.5	45	2.250

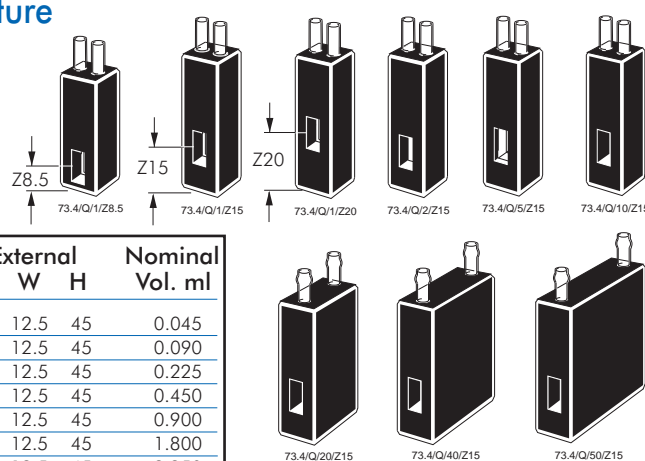

Type 73.65 Flow cells. Dissolution, wide aperture

- Two polished windows.
- Inlet/outlet tubes - 2 I.D, 4 O.D, 10mm long intended for push-on flexible tubing.
- Cells with a Z height of 8.5mm have an overall height of 38.5mm.

Type No.	Window Material	Path Length	Z Height	Internal		External			Nominal Vol. ml
				W	H	L	W	H	
73.65	Q	1	8.5, 15, 20	6.5	11	12.5	12.5	45	0.072
73.65	Q	2	8.5, 15, 20	6.5	11	12.5	12.5	45	0.144
73.65	Q	5	8.5, 15, 20	6.5	11	12.5	12.5	45	0.360
73.65	Q	10	8.5, 15, 20	6.5	11	12.5	12.5	45	0.720
73.65	Q	20	8.5, 15, 20	6.5	11	22.5	12.5	45	1.440
73.65	Q	40	8.5, 15, 20	6.5	11	42.5	12.5	45	2.880
73.65	Q	50	8.5, 15, 20	6.5	11	52.5	12.5	45	3.600

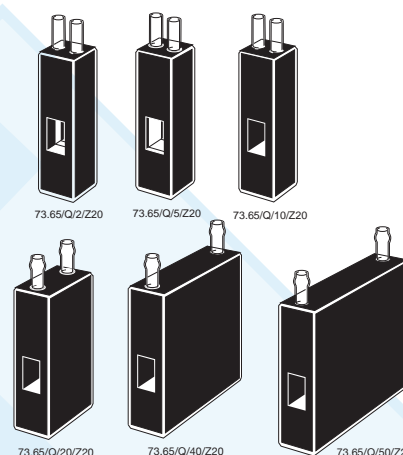

Type 74.4 Flow cells. Dissolution. Short path length, long aperture

- Two polished windows.
- Path lengths of 0.5mm or less incorporate by-pass tubes to avoid back pressure and assist laminar flow through the sample compartment. Profiled sample compartment to optimise flow characteristics, reduces carry-over and bubble retention.
- Inlet/outlet tubes - 2 I.D, 4 O.D, 10mm long intended for push-on flexible tubing.

Type No.	Window Material	Path Length	Z Height	Internal		External			Nominal Vol. ml
				W	H	L	W	H	
74.4	Q	0.1	15	4	17.5	12.5	12.5	35	0.042
74.4	Q	0.2	15	4	17.5	12.5	12.5	35	0.049
74.4	Q	0.5	15	4	17.5	12.5	12.5	35	0.100
74.4	Q	1	15	4	17.5	12.5	12.5	35	0.135
74.4	Q	2	15	4	17.5	12.5	12.5	35	0.200

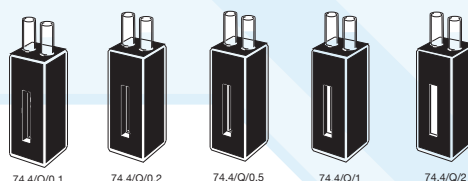

Advantages of Starna® Type 583, 584, 576, 577 & 585 series flow cells

(for 576, 577 & 583 see page 20)

- Fully fused body, accurately located in precisely formed extruded CNC drilled enclosure.
- Superior design, firm and accurate positioning of screw-in M6 gripper fittings with PTFE tubing, without reliance on the shear strength of intermediate bonding material.
- Polished top surface of the cell creates a positive seal with the PTFE face of the M6 gripper fitting, (see illustration), ensures a leak proof seal without dislodging the cell body or damaging the cell surface.
- A gap of ~300 microns between the top of the cell body and the enclosure allows confirmation of a positive seal before use.
- Internally profiled inlet and outlet to each sample chamber optimises flow characteristic and performance, providing a smooth laminar flow wherever possible and reduces bubble retention.
- All cells are pressure tested to more than 5 bar after final assembly.
- Each cell is engraved with the path length and a unique identifying number, for full traceability throughout the manufacturing process.
- Cells with path lengths of less than 0.5mm or less are checked on a reference spectrophotometer before and after final assembly using an interference method. The path length is determined to an uncertainty better than 0.2 microns (0.0002mm). Path lengths of 0.5mm or greater are verified by physical measurement during the production processes.
- Flanged fittings, FEP tubing, and special adaptors Type TJ/G/038 for use with normal silicone tubing are available, see page 29.
- Short path length flow cells may be used as static short path length using a syringe and luer lock adaptor (see illustration).

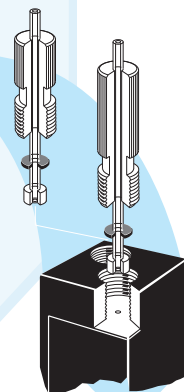

Type 583.2.8 Flow cells. Dissolution. Micro aperture

- Two polished windows.
- M6 Screw-in connections.
- Profiled sample compartment to optimise flow characteristics, reduces carry-over and bubble retention.

Type No.	Window Material	Path Length	Z Height	Internal W	Internal H	External L	External W	External H	Nominal Vol. ml
583.2.8	Q	10	8.5, 15	2	8	12.5	12.5	35	0.160

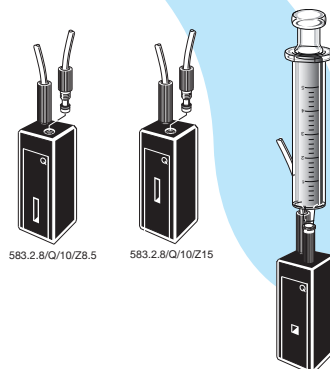

Type 583.3.3. Flow cells. Sub-micro. Small aperture

- Two polished windows.
- Overflow tube attached to outlet side of cell.
- M6 fittings as described, included with cell.
- Also designed for use with luer lock fitting and syringe for introduction and extraction of sample.

Type No.	Window Materials	Path Length	Z Height	Internal W	Internal H	External W	External H	Nominal Vol. ml
583.3.3	Q	1	15	3	3	12.5	35	0.009
583.3.3	Q	2	15	3	3	12.5	35	0.018
583.3.3	Q	5	15	3	3	12.5	35	0.045

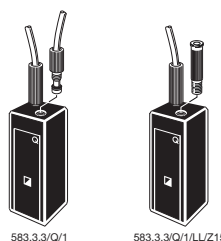

Z Dimension per instrument

Manufacturer	Z Dimension
Agilent®	15mm
Beckman®	8.5mm
Bio-Rad®	8.5mm
Eppendorf®	8.5mm
GBC®	15mm
Hewlett Packford®	15mm
Hitachi®	8.5mm
Jasco®	12mm
Perkin-Elmer®	15mm
Pharmacia®	15mm
Scinco®	15mm
Shimadzu®	15mm
Spectronics®	8.5mm
Turner®	8.5mm
Varian® (Cary®/Agilent®)	20mm

Type 583.4 & 583.4.14 Flow cells. Dissolution. Medium Aperture

- Two polished windows.
- M6 Screw-in connections.
- Profiled sample compartment to optimise flow characteristics, reduces carry-over and bubble retention.

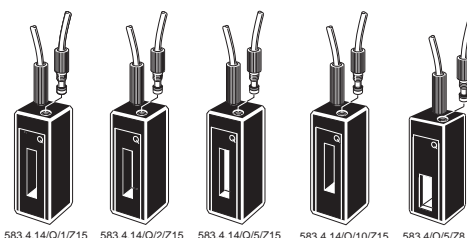

Type No.	Window Materials	Path Length	Z Height	Internal W	Internal H	External W	External H	Nominal Vol. ml
583.4.14	Q	1	15, 20	4	14	12.5	35	0.056
583.4.14	Q	2	15, 20	4	14	12.5	35	0.112
583.4.14	Q	5	15, 20	4	14	12.5	35	0.280
583.4.14	Q	10	15, 20	4	14	12.5	35	0.560
583.4	Q	5	8.5, 15, 20	4	11	12.5	35	0.225
583.4	Q	10	8.5, 15, 20	4	11	12.5	35	0.450
583.4	Q	20	8.5, 15, 20	4	11	12.5	35	0.900
583.4	Q	40	8.5, 15, 20	4	11	12.5	35	1.800
583.4	Q	50	8.5, 15, 20	4	11	12.5	35	2.250
583.4	Q	100	8.5, 15, 20	4	11	12.5	35	4.500

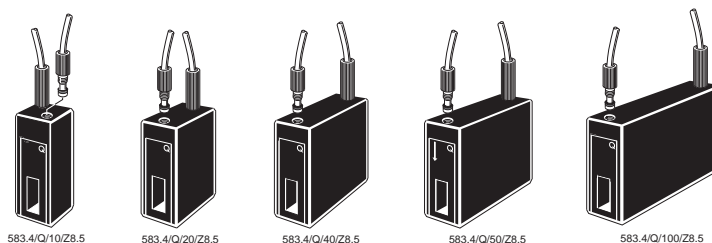

G = Optical Glass 334-2500nm SOG = Special Optical Glass 320-2500nm PX = Borosilicate 325-2500nm HH = UV Silica 220-2500nm
 Q = Far UV Quartz 170-2700nm I = Near Infra-Red Quartz 220-3800nm SX = Far UV to Near IR Quartz (Water free) 170-3500nm

Type 583.65 Flow cells. Dissolution. Wide aperture

- Two polished windows.
- Cells with a Z height of 20mm have overall an height of 40mm.
- Path lengths of 0.5mm or less incorporate by-pass tubes to avoid back pressure and assist laminar flow through the sample compartment.
- M6 Screw-in connections.
- Profiled sample compartment to optimise flow characteristics, reduce carry-over and bubble retention.

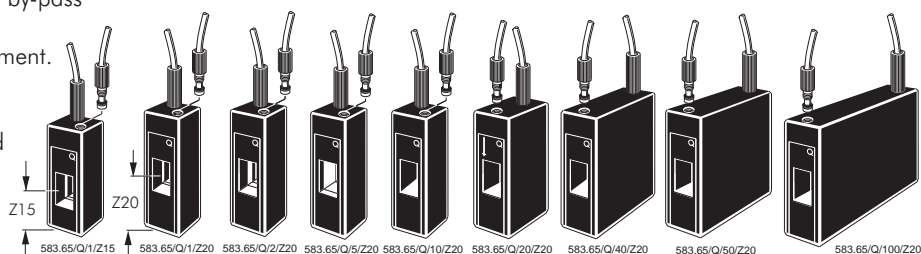

Type No.	Window Material	Path Length	Z Height	Internal		External			Nominal Vol. ml
				W	H	L	W	H	
583.65	Q	0.1	15, 20	6.5	11	12.5	12.5	35	0.029
583.65	Q	0.2	15, 20	6.5	11	12.5	12.5	35	0.036
583.65	Q	0.5	15, 20	6.5	11	12.5	12.5	35	0.072
583.65	Q	1	15, 20	6.5	11	12.5	12.5	35	0.072
583.65	Q	2	15, 20	6.5	11	12.5	12.5	35	0.290
583.65	Q	5	15, 20	6.5	11	12.5	12.5	35	0.360
583.65	Q	10	15, 20	6.5	11	12.5	12.5	35	0.720
583.65	Q	20	15, 20	6.5	11	22.5	12.5	35	1.400
583.65	Q	40	15, 20	6.5	11	42.5	12.5	35	2.900
583.65	Q	50	15, 20	6.5	11	52.5	12.5	35	3.600
583.65	Q	100	15, 20	6.5	11	102.5	12.5	35	7.200



Type 583.65.65 Flow cells. Dissolution. Wide square aperture

- Two polished windows.
- Cells with a Z height of 20mm have overall an height of 40mm.
- M6 Screw-in connections.
- Profiled sample compartment to optimise flow characteristics, reduces carry over and bubble retention.
- Aperture with reduced height and volume for specific instruments such as Agilent 8453 and Varian Cary 50.

Type No.	Window Material	Path Length	Z Height	Internal		External			Nominal Vol. ml
				W	H	L	W	H	
583.65.65	Q	1	15, 20*	6.5	6.5	12.5	12.5	35	0.076
583.65.65	Q	2	15, 20*	6.5	6.5	12.5	12.5	35	0.160
583.65.65	Q	5	15, 20*	6.5	6.5	12.5	12.5	35	0.210
583.65.65	Q	10	15, 20*	6.5	6.5	12.5	12.5	35	0.420

* When Z height is 20mm, external height is 40mm



Type 584.4 Flow cells. Dissolution. Short path length, long aperture

- Two polished windows.
- Long aperture.
- Path lengths of 0.5mm or less incorporate by-pass tubes to avoid back pressure and assist laminar flow through the sample compartment.
- M6 Screw-in connections.
- Profiled sample compartment to optimise flow characteristics, reduces carry over and bubble retention.

Type No.	Window Material	Path Length	Z Height	Internal		External			Nominal Vol. ml
				W	H	L	W	H	
584.4	Q	0.01	8.5, 15, 20*	4	17.5	12.5	12.5	35	0.036
584.4	Q	0.05	8.5, 15, 20*	4	17.5	12.5	12.5	35	0.039
584.4	Q	0.1	8.5, 15, 20*	4	17.5	12.5	12.5	35	0.041
584.4	Q	0.2	8.5, 15, 20*	4	17.5	12.5	12.5	35	0.047
584.4	Q	0.5	8.5, 15, 20*	4	17.5	12.5	12.5	35	0.095
584.4	Q	1	8.5, 15, 20*	4	17.5	12.5	12.5	35	0.120
584.4	Q	2	8.5, 15, 20*	4	17.5	12.5	12.5	35	0.240

* When Z height is 20mm, external height is 40mm

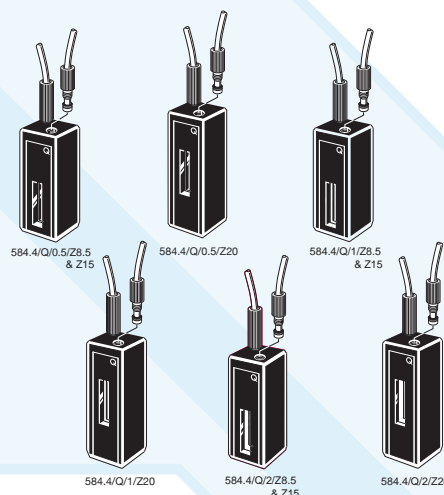

Type 76. Flow cells HPLC, round aperture with stainless steel tubes

- Two polished windows.
- Stainless steel inlet/outlet tubes.
- Cells with a Z height of 8.5mm have an overall height of 38.5mm.

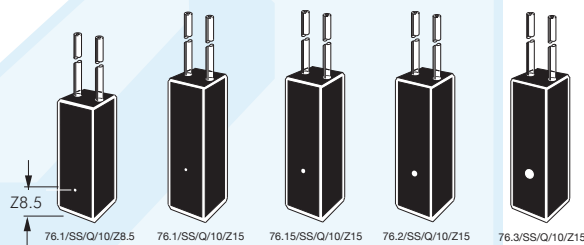

Type No.	Window Materials	Path Length	Z Height	Internal Dia.	External			Nominal Vol. ml	Stainless steel tubes				
					L	W	H		Inlet I.D.	I.D.	O.D.	Outlet I.D.	O.D.
76.1	Q	10	8.5, 15	1	12.5	12.5	45	0.008	0.25	1.6	0.5	1.6	100
76.15	SOG, Q	10	8.5, 15	1.5	12.5	12.5	45	0.018	1.0	1.6	1.0	1.6	100
76.2	SOG, Q	10	8.5, 15	2	12.5	12.5	45	0.040	1.0	1.6	1.0	1.6	100
76.3	SOG, Q	10	8.5, 15	3	12.5	12.5	45	0.080	1.0	1.6	1.0	1.6	100

Type 15. Micro aspiration

- Two polished windows.
- Open top.
- Filling and emptying with a pipette is recommended.



Type No.	Window Material	Path Length	Z Height	Internal		External			Nominal Vol. ml
				W	H	L	W	H	
15.50A	Q	10	8.5	-	13.5	12.5	12.5	15	0.050

Type 25. Micro & semi-micro. Vacuum suction/aspiration

- Two polished windows.
- Inlet/outlet tubes - 2 I.D., 4 O.D., 10mm long intended for push-on flexible tubing.
- Funnel supplied with cell.

Type No.	Window Materials	Path Length	Internal W	External L	External W	External H	Base to Block (BB)	Nominal Vol. ml
Micro. Clear walls								
25.2	SOG, Q	10	2	12.5	12.5	45	26	0.500
Micro. Black walls. Self-masking								
25.2/B	SOG, Q	10	2	12.5	12.5	45	26	0.500
Semi-micro. Clear walls								
25.4	SOG, Q	10	4	12.5	12.5	45	26	1.000
Semi-micro. Black walls. Self-masking								
25.4/B	SOG, Q	10	4	12.5	12.5	45	26	1.000
25.4.18/B	SOG, Q	10	4	12.5	12.5	64	44	0.750

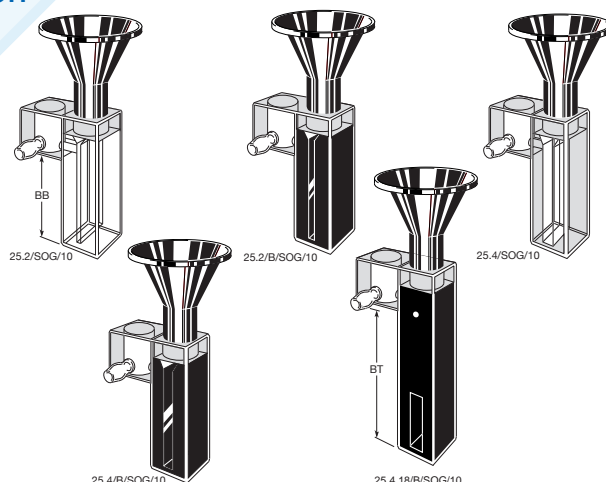

Type 28-AS. Micro, suction outlet

Type 29-AS. Semi-micro, suction outlet

- Two polished windows.
- Inlet/outlet tubes - 2 I.D., 4 O.D., 10mm long intended for push-on flexible tubing.
- Funnel supplied with cell.

Type No.	Window Materials	Path Length	Internal W	External L	External W	External H	Base to Tube (BT)	Nominal Vol. ml
Micro. Clear walls								
28-AS	SOG, Q	10	2	12.5	12.5	48	31	0.500
Micro. Black walls. Self-masking								
28-AS/B	SOG, Q	10	2	12.5	12.5	48	31	0.500
Semi-micro. Clear walls								
29-AS	SOG, Q	10	4	12.5	12.5	48	31	1.000
Semi-micro. Black walls. Self-masking								
29-AS/B	SOG, Q	10	4	12.5	12.5	48	31	1.000
29/AS60/B	Q	10	4	12.5	12.5	60	46.5	1.200
29/AS70/B	SOG, Q	10	4	12.5	12.5	70	55	1.800



Type 75.1, 75.15 Flow cells. Ultra-micro, round aperture

- Two polished windows.
- Cells with a Z height of 8.5mm have an overall height of 38.5mm.
- Bore specially treated to reduce bubble formation and/or retention.
- Inlet/outlet tubes - 2 I.D, 4 O.D, 10mm long intended for push-on flexible tubing.

Type No.	Window Material	Path Length	Z Height	Internal Dia.	External L	External W	External H	Nominal Vol. ml
75.1	Q, SX	5	8.5,15	1	12.5	12.5	35	0.036
75.1	SOG, Q, SX	10	8.5,15	1	12.5	12.5	35	0.039
75.15	Q, SX	1	8.5,15	1.5	12.5	12.5	35	0.041
75.15	Q, SX	2	8.5,15	1.5	12.5	12.5	35	0.047
75.15	Q, SX	5	8.5,15	1.5	12.5	12.5	35	0.095
75.15	SOG, Q, SX	10	8.5,15	1.5	12.5	12.5	35	0.120
75.15	Q, SX	20	8.5,15	1.5	22.5	12.5	35	0.240
75.15	Q, SX	50	8.5,15	1.5	52.5	12.5	35	0.600

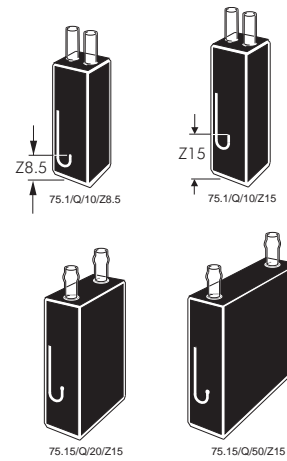

Type 75.2 Flow cells. Sub-micro, round aperture

- Two polished windows.
- Cells with a Z height of 8.5mm have an overall height of 38.5mm.
- Bore specially treated to reduce bubble formation and/or retention.
- Inlet/outlet tubes - 2 I.D, 4 O.D, 10mm long intended for push-on flexible tubing.

Type No.	Window Material	Path Length	Z Height	Internal Dia.	External L	External W	External H	Nominal Vol. ml
75.2	SOG, Q, SX	2	8.5,15	2	12.5	12.5	45	0.007
75.2	SOG, Q, SX	5	8.5,15	2	12.5	12.5	45	0.016
75.2	SOG, Q, SX	10	8.5,15	2	12.5	12.5	45	0.032
75.2	SOG, Q, SX	40	8.5,15	2	42.5	12.5	45	0.128

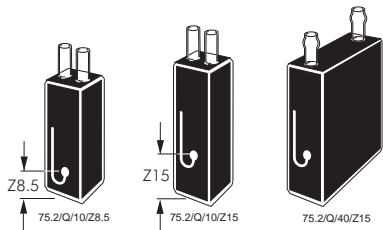

Type 75.3 Flow cells. Round aperture

- Two polished windows.
- Cells with a Z height of 8.5mm have an overall height of 38.5mm.
- Bore specially treated to reduce bubble formation and/or retention.
- Inlet/outlet tubes - 2 I.D, 4 O.D, 10mm long intended for push-on flexible tubing.

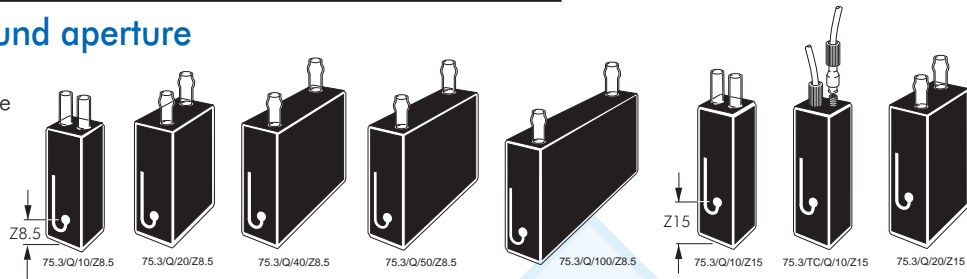

Type No.	Window Material	Path Length	Z Height	Internal W	Internal H	External L	External W	External H	Nominal Vol. ml	Remarks
75.3	SOG, Q	1	8.5,15	3	1	12.5	12.5	45	0.007	
75.3	SOG, Q	2	8.5,15	3	2	12.5	12.5	45	0.014	
75.3	SOG, Q	5	8.5,15	3	5	12.5	12.5	45	0.035	
75.3	SOG, Q, SX	10	8.5,15	3	10	12.5	12.5	45	0.070	
75.3/TC	Q	10	15, 20	3	10	12.5	12.5	45	0.070	Screw-on connections
75.3	SOG, Q	20	8.5,15	3	20	22.5	12.5	45	0.140	
75.3	SOG, Q	40	8.5,15	3	40	42.5	12.5	45	0.280	
75.3	SOG, Q	50	8.5,15	3	50	52.5	12.5	45	0.350	
75.3	SOG, Q	100	8.5,15	3	100	102.5	12.5	45	0.700	

Type 75.1-V Flow cells. Ultra-micro, sub-micro, round aperture vacuum/debubbler

- Two polished windows.
- Cells with a Z height of 8.5mm have an overall height of 38.5mm.
- Bore specially treated to reduce bubble formation and/or retention.
- Inlet/outlet tubes - 2 I.D, 4 O.D, 10mm long intended for push-on flexible tubing.
- Third outlet debubbler tube - 2 I.D, 4 O.D, 10mm long.

Type No.	Window Material	Path Length	Z Height	Internal Dia.	External L	External W	External H	Nominal Vol. ml
75.1-V	Q	10	8.5,15	1	12.5	12.5	45	0.008
75.2-V	Q	10	8.5,15	2	12.5	12.5	45	0.040

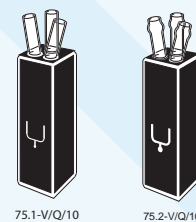

Type 576 Ultra micro, round aperture with stainless steel tubes

- Two polished windows.
- Bore specially treated to reduce bubble formation and/or retention.
- Stainless steel inlet/outlet tubes. Nominal length 100mm.

Type No.	Window Material	Path Length	Z Height	Internal Dia.	External			Nominal Vol. ml	Stainless steel tubes				
					L	W	H		Inlet I.D.	Inlet O.D.	Outlet I.D.	Outlet O.D.	L
576.15	SOG, Q	10	8.5	1,5	12.5	12.5	35	0.018	1.0	1.6	1.0	1.6	100
576.20	SOG, Q	10	8.5	2,0	12.5	12.5	35	0.032	1.0	1.6	1.0	1.6	100

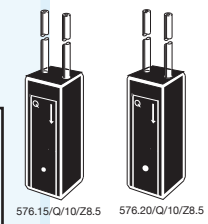

Type 577 Ultra micro round aperture

- Two polished windows.
- Bore specially treated to reduce bubble formation and/or retention.
- M6 screw-in connections.
- Long body or short body 576.15/S.

Type No.	Window Material	Path Length	Z Height	Internal Dia.	External			Nominal Vol. ml
					L	W	H	
577.15	SOG	10	8.5	1,5	12.5	12.5	35	0.018
577.15/S	SOG	10	8.5	1,5	12.5	12.5	35	0.018

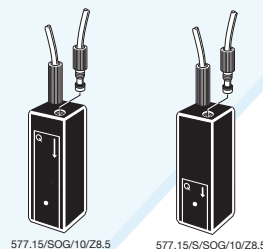

Type 585.1, 585.15 Flow cells. Ultra-micro, round aperture

- Two polished windows.
- Bore specially treated to reduce bubble formation and/or retention.
- M6 screw-in connections.

Type No.	Window Material	Path Length	Z Height	Internal Dia.	External			Nominal Vol. ml
					L	W	H	
585.1	SOG, Q	10	8.5, 15, 20*	1	12.5	12.5	35	0.008
585.15	SOG, Q	10	8.5, 15, 20*	1.5	12.5	12.5	35	0.018

* When Z height is 20mm, external height is 40mm

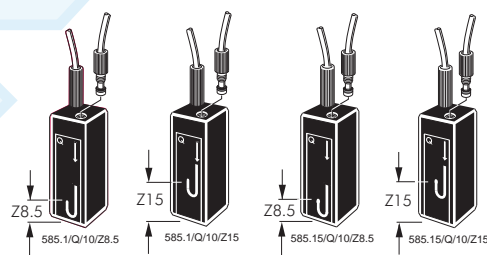

Type 585.2 Flow cells. Sub-micro, round aperture

- Two polished windows.
- Bore specially treated to reduce bubble formation and/or retention.
- M6 screw-in connections.

Type No.	Window Material	Path Length	Z Height	Internal Dia.	External			Nominal Vol. ml
					L	W	H	
585.2	SOG, Q, SX	10	8.5, 15, 20*	2	12.5	12.5	35	0.032

* When Z height is 20mm, external height is 40mm

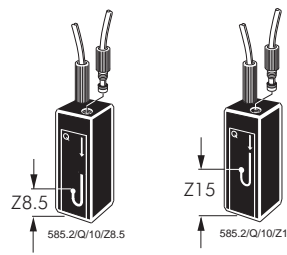

Type 585.3 Flow cells, round aperture

- Two polished windows.
- Bore specially treated to reduce bubble formation and/or retention.
- M6 screw-in connections.

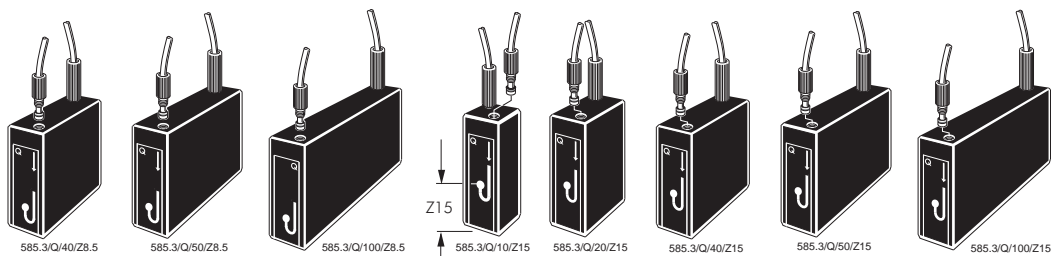

Type No.	Window Material	Path Length	Z Height	Internal Dia.	External			Nominal Vol. ml
					L	W	H	
585.3	SOG, Q	10	8.5, 15, 20*	3	12.5	12.5	35	0.070
585.3	SOG, Q	20	8.5, 15, 20*	3	22.5	12.5	35	0.140
585.3	SOG, Q	40	8.5, 15, 20*	3	42.5	12.5	35	0.280
585.3	SOG, Q	50	8.5, 15, 20*	3	52.5	12.5	35	0.350
585.3	SOG, Q	100	8.5, 15, 20*	3	102.5	12.5	35	0.700

* When Z height is 20mm, external height is 40mm

Z Dimension per instrument	
Manufacturer	Z Dimension
Agilent®	15mm
Beckman®	8.5mm
Bio-Rad®	8.5mm
Eppendorf®	8.5mm
GBC®	15mm
Hewlett Packford®	15mm
Hitachi®	8.5mm
Jasco®	12mm
Perkin-Elmer®	15mm
Pharmacia®	15mm
Scinco®	15mm
Shimadzu®	15mm
Spectronics®	8.5mm
Turner®	8.5mm
Varian® (Cary®/Agilent®)	20mm

Type 3. Fluorimeter. Macro/Standard Rectangular

- Open top, with non-sealing PTFE cover.
- Polyethylene vaned lid available on request for 10mm cells only, providing a liquid-tight seal.
- Four windows and base polished.

Type No.	Window Materials	Path Length	Internal Width	External L	External W	External H	Nominal Vol. ml
3	Q	2	10	4.5	12.5	45	0.800
3	G, SOG, Q, I, SX	5	10	7.5	12.5	45	1.70
3	G, SOG, PX, Q, I, SX	10	10	12.5	12.5	45	3.500
3	G, SOG, Q, I	20	10	22.5	12.5	45	7.000
3	G, SOG, Q, I	40	10	42.5	12.5	45	14.000
3	G, SOG, Q, I	50	10	52.5	12.5	45	17.500
3	G, SOG, Q, I, SX	100	9.5	102.5	12.5	45	35.000
3.18	Q	18	18	22	22	50	14.600
3.26	Q	26	26	30	30	50	30.500

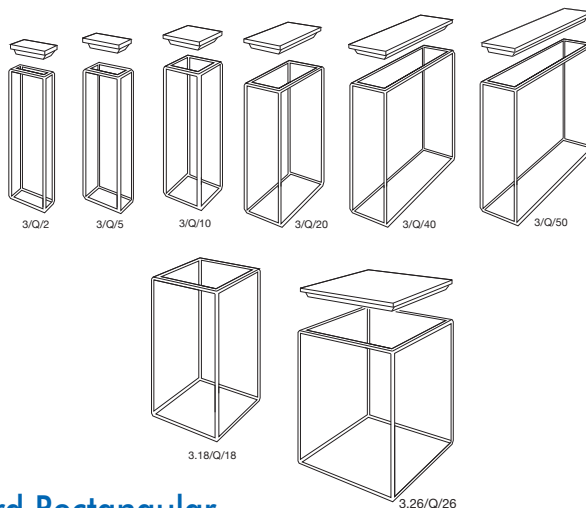

Type 23. Fluorimeter with stopper(s). Macro/Standard Rectangular

- Closed by PTFE stopper(s), providing a liquid-tight seal.
- Four windows and base polished. * LB = Long stopper block

Type No.	Window Materials	Path Length	Internal Width	External L	External W	External H	Nominal Vol. ml
23	G, SOG, Q, I, SX	5	10	7.5	12.5	48	1.700
23	G, SOG, Q, I, SX	10	10	12.5	12.5	48	3.500
23	G, SOG, Q, I	20	10	22.5	12.5	48	7.000
23	G, SOG, Q, I	40	10	42.5	12.5	48	7.00
23	G, SOG, Q, I	50	10	52.5	12.5	48	17.500
23	Q	100	10	102.5	12.5	48	35.000
23-LB *	Q	10	10	12.5	12.5	42	3.000

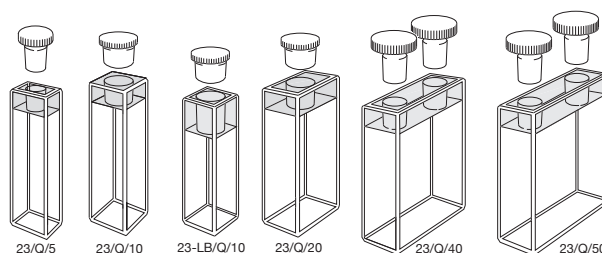

Type 9-F & 29-F Fluorimeter. Semi-micro. Type 17-F, 18-F & 28-F Fluorimeter. Micro

- Fits 12.5mm square cell holder.
- Four windows and base polished.
- **Type 9-F, 17-F & 18-F** have open top with non-sealing PTFE cover.
- **Type 28-F & 29-F** are closed by PTFE stopper, providing a liquid-tight seal.
- Base thickness - 3mm
- Suitable for use with all standard cell holders.

Type No.	Window Materials	Path Length	Internal Width	External L	External W	External H	Nominal Vol. ml	Remarks
9-F	SOG, Q	10	4	12.5	12.5	45	1.400	Semi-micro with lid
29-F	SOG, Q	10	4	12.5	12.5	48	1.400	Semi-micro with stopper
17-F	G, Q	10	2	12.5	12.5	25	0.400	Micro with lid
18-F	SOG, Q	10	2	12.5	12.5	45	0.700	Micro with lid
28-F	SOG, Q	10	2	12.5	12.5	48	0.700	Micro with stopper

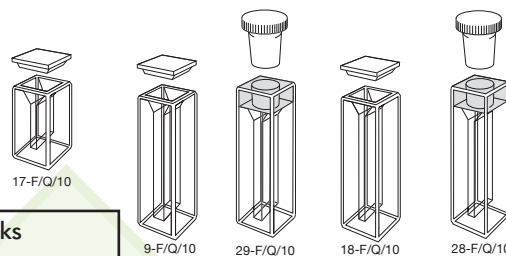

Type 3-. Fluorimeter. Micro. Type 23-. Fluorimeter. Micro, with stopper

- Four polished windows.
- This range of micro fluorimeter cells is specially designed to be used with the FCA adaptors. The appropriate adaptor for the path length correctly aligns the cell in a standard 12.5mm square cell holder to maximise excitation and emission energy utilisation.

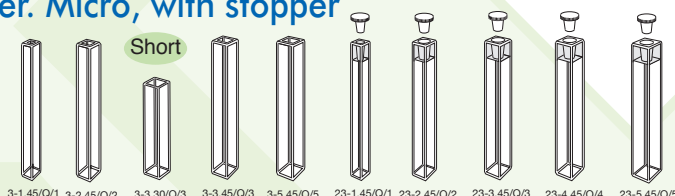

Type No.	Window Materials	Path Length	Internal Width	External L	External W	External H	Adaptor	Nominal Vol. ml
Square open top								
3-1.45	Q	1	1	3.5	3.5	45	FCA1	0.035
3-2.45	SOG, Q	2	2	4.5	4.5	45	FCA2	0.140
3-3.30	SOG, Q	3	3	5.5	5.5	30	FCA3.30	0.225
3-3.45	SOG, Q	3	3	5.5	5.5	45	FCA3	0.315
3-4.45	SOG, Q	4	4	6.5	6.5	45	FCA4	0.560
3-5.45	SOG, Q	5	5	7.5	7.5	45	FCA5	0.875
With stopper								
23-1.45	Q	1	1	3.5	3.5	48	FCA1	0.031
23-2.45	SOG, Q	2	2	4.5	4.5	48	FCA2	0.125
23-3.45	SOG, Q	3	3	5.5	5.5	48	FCA3	0.280
23-4.45	SOG, Q	4	4	6.5	6.5	48	FCA4	0.500
23-5.45	SOG, Q	5	5	7.5	7.5	48	FCA5	0.780

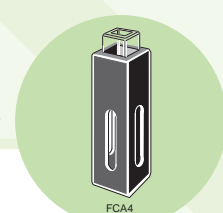

Type 3-. Fluorimeter. Micro, supplied without lid

Type 23-4. Fluorimeter. Micro with stopper

- Open top cell.
- **Type 23-4** is closed by PTFE stopper, providing a liquid-tight seal.
- Four windows and base polished.

Type No.	Window Materials	Path Length	Internal Width	External L W H			Nominal Vol. ml
3-3	SOG, Q	3	3	5.5	5.5	30	0.270
3-4	SOG, Q	4	4	6	6	50	0.720
3-5	SOG, Q	5	5	6.8	6.8	40	0.875
23-4	SOG, Q	4	4	6	6	50	0.720

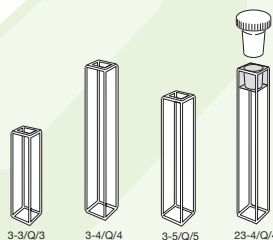

Z Dimension for some fluorimeters

Manufacturer	Z Dimension
Jasco®	18mm
Molecular Devices®	15mm
Perkin-Elmer®	15mm
Pharmacia®	15mm
PTI (Photo Technology)®	15mm
Shimadzu®	15mm
SLM/Spectronics®	15mm
Hewlett Packford®	15mm
Spectra Max®	15mm
Spex®	15mm
TSS®	15mm
Varian® (Cary®/Agilent®)	20mm

Type 11. Open top. Type 22 with stopper. Fluorimeter. Micro.

- Open top cell.
- **Type SBT15** with 10mm I.D. tube for rubber septa seal for Anærobic environments.
- All sides and base polished.

Type No.	Window Materials	Path Length	Internal Width	External L W H			Nominal Vol. ml
11.1	Q	1	1	12.5	12.5	45	0.040
11.2	Q	2	2	12.5	12.5	45	0.160
11.3	Q	3	3	12.5	12.5	45	0.360
22.1	Q	1	1	12.5	12.5	48	0.040
22.2	Q	2	2	12.5	12.5	48	0.160
22.3	Q	3	3	12.5	12.5	48	0.360
11.1/SBT15	Q	1	1	12.5	12.5	59	0.040
11.2/SBT15	Q	2	2	12.5	12.5	59	0.160
11.3/SBT15	Q	3	3	12.5	12.5	59	0.360

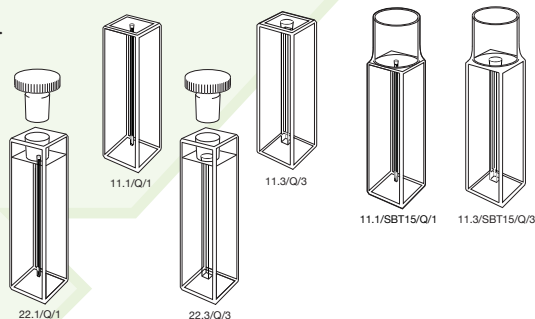

Type 16-F & 26-F. Fluorimeter. Sub-micro

- Three polished windows.
- Sub-micro volumes from 10µl to 160µl.
- **Type 16** has a top; comprising two black walls, two translucent side walls and a square internal cross section.
- Open top, supplied with non-sealing PTFE cover as well as a vaned lid to provide a liquid-tight seal.
- To avoid possible meniscus errors; it may be necessary to increase the nominal sample fill volume by at least 20%.
- May be used with all standard cell holders.
- Filling and emptying with a pipette is recommended.
- **Type 16.10-F4** has four polished windows.

Type No.	Window Material	Path Length	Z Height	Internal W H		Emission window W H		External L W H			Nominal Vol.ml	
Square open top												
16.10-F	Q	10	8.5,15, 20	1	1	10	1	12.5	12.5	45	0.010	
16.10-F4	Q	10	8.5,15, 20	1	1	10	1	12.5	12.5	45	0.010	
16.12-F	Q	1.5	8.5,15, 20	1.5	5	1.5	5	12.5	12.5	45	0.012	
16.40-F	Q	10	8.5,15, 20	2	2	10	2	12.5	12.5	45	0.040	
16.45-F	Q	3	8.5,15, 20	3	5	3	5	12.5	12.5	45	0.045	
16.4.3-F	Q	10	8.5,15, 20	4	3	10	3	12.5	12.5	45	0.120	
16.50-F	Q	10	8.5,15, 20	2	2.5	10	2.5	12.5	12.5	45	0.050	
16.100-F	Q	10	8.5,15, 20	2	5	10	5	12.5	12.5	45	0.100	
16.160-F	Q	10	8.5,15, 20	2	8	10	8	12.5	12.5	45	0.160	
16.400-F	Q	10	8.5,15, 20	10	4	10	4	12.5	12.5	45	0.400	
16.1000-F	Q	10	8.5,15, 20	10	10	10	10	12.5	12.5	45	1.000	
With stopper												
26.10-F	Q	10	8.5,15, 20	1	1	10	1	12.5	12.5	48	0.010	
26.12-F	Q	1.5	8.5,15, 20	1.5	5	1.5	5	12.5	12.5	48	0.012	
26.40-F	Q	10	8.5,15, 20	2	2	10	2	12.5	12.5	48	0.040	
26.45-F	Q	3	8.5,15, 20	3	5	3	5	12.5	12.5	48	0.045	
26.4.3-F	Q	10	8.5,15, 20	4	3	10	3	12.5	12.5	48	0.120	
26.50-F	Q	10	8.5,15, 20	2	2.5	10	2.5	12.5	12.5	48	0.050	
26.100-F	Q	10	8.5,15, 20	2	5	10	5	12.5	12.5	48	0.100	
26.160-F	Q	10	8.5,15, 20	2	8	10	8	12.5	12.5	48	0.160	
26.400-F	Q	10	8.5,15, 20	10	4	10	4	12.5	12.5	48	0.400	

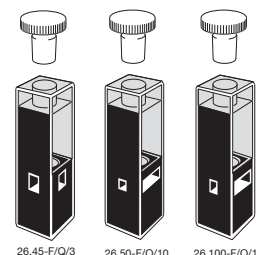
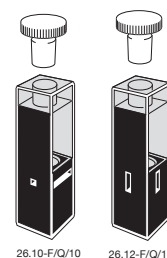
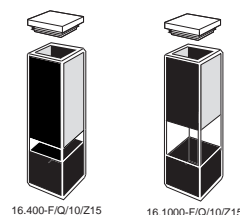
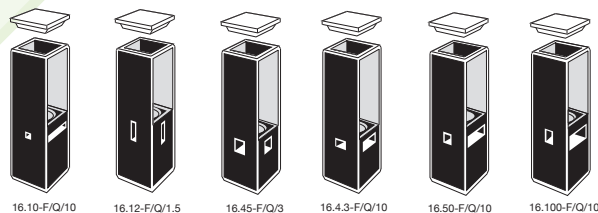

Type 19.05F/L/Q/5/Z../MC Ultra-micro lens cell

- Four polished windows, with windows opposite the emission and excitation windows mirror coated to increase performance.
- **Type 19.05F/L** is a patented design with integral lens primarily designed for use with small cross section focussed beam instruments.
- The lens colimates the emission energy leaving the sample chamber onto the detector.
- Sample inserted and retrieved with micro pipette tip.

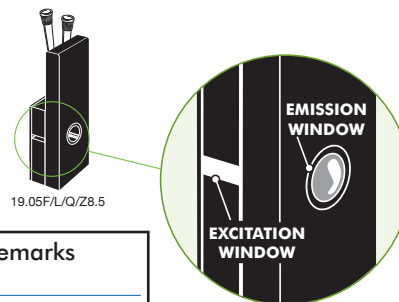

Type No.	Window Material	Path Length	Z Height	Internal		External			Nominal Vol. ml	Remarks
				L	W	L	W	H		
19.05F/L	Q	5	8.5*, 15, 20	1	1	12.5	12.5	45	0.0050	*Cell height-38.5mm

Type 4. Fluorimeter. Open top, Type 24 with stopper. Fluorimeter. Triangular

- Fits 12.5mm square cell holder.
- Three windows and base polished.
- **Type 24/SB/B**, self-masking.

Type No.	Window Material	Internal		External			Nominal Vol. ml	Remarks
		L	W	L	W	H		
Open top								
4-SB	Q	10	10	12.5	12.5	45	1.700	Square base
4-TB	Q	10	10	12.5	12.5	45	1.700	Triangular base
With stopper								
24-SB	Q	10	10	12.5	12.5	48	1.700	Square base
24-TB	Q	10	10	12.5	12.5	48	1.700	Triangular base
24-SB/B	Q	10	10	12.5	12.5	48	1.700	Z8.5, Z15, Z20

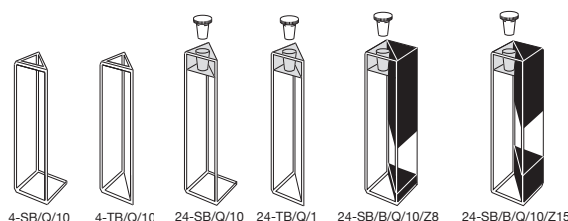

Type 52. with lid. Type 53 with stopper. Dual Path Length or Fluorimeter

- All windows and base polished.
- May be used as dual path length absorption cells or fluorimeter cells.
- Volumes equivalent to micro and semi-micro cells depending on internal width.

Type No.	Window Material	Path Length	Internal Width		External			Nominal Vol. ml
			L	W	L	W	H	
Open top								
52	SOG,Q	1 or 10	1 x 10	12.5	12.5	45	0.400	
52	SOG,Q	2 or 10	2 x 10	12.5	12.5	45	0.800	
52	SOG,Q	3 or 10	3 x 10	12.5	12.5	45	1.200	
52	SOG,Q	4 or 10	4 x 10	12.5	12.5	45	1.600	
52	SOG,Q	5 or 10	5 x 10	12.5	12.5	45	2.000	
With stopper								
53	SOG,Q	1 or 10	1 x 10	12.5	12.5	48	0.400	
53	SOG,Q	2 or 10	2 x 10	12.5	12.5	48	0.800	
53	SOG,Q	3 or 10	3 x 10	12.5	12.5	48	1.200	
53	SOG,Q	4 or 10	4 x 10	12.5	12.5	48	1.600	
53	SOG,Q	5 or 10	5 x 10	12.5	12.5	48	2.000	

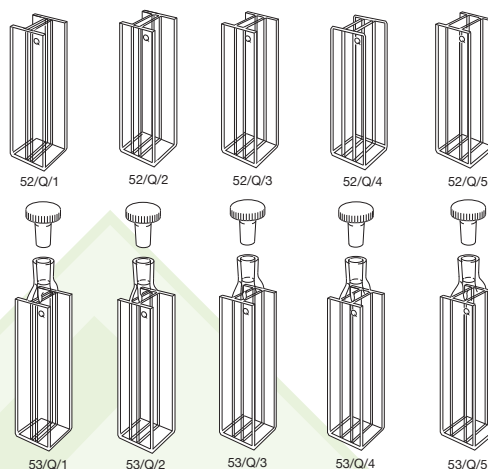

Type 55, 57 with lid & 56, 58 with stopper(s). Tandem, Divided, Mixing or Fluorimeter

- All windows polished except **Type 55-1/Q/10**.
- **Types 55 and 56** are for measuring two samples in series in separate compartments.
- **Types 57 and 58** are designed for mixing two samples after measuring in series.

Type No.	Window Material	Path Length	Internal Length	External			Nominal Vol. ml	Remarks
				L	W	H		
55	Q	2 x 10	2 x 4.375	12.5	12.5	45	2 x 1.500	Tandem or divided with lid
55-1	Q	2 x 10	2 x 10	23.75	12.5	45	2 x 3.500	Tandem or divided. Frosted sides. Open top
56	Q	2 x 10	2 x 4.375	12.5	12.5	48	2 x 1.500	Tandem or divided with stoppers
57	Q	2 x 10	2 x 4.375	12.5	12.5	45	2 x 1.000	Tandem mixing with lid
58	Q	2 x 10	2 x 4.375	12.5	12.5	48	2 x 1.000	Tandem mixing with stoppers

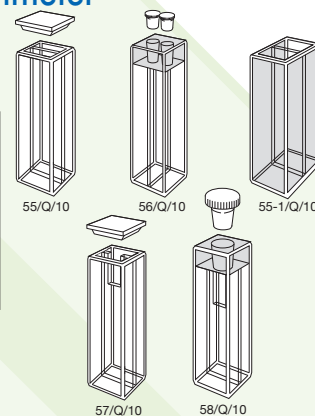

Type 59. Cube, Fluorimeter with tube

- Five windows polished

Type No.	Window Materials	Path Length	Internal Width	External			Tube		Nominal Vol. ml	
				L	W	H	ID. OD.	Length		
59	SOG, Q, I	10	10	12.5	12.5	48	2	4	70	1.00

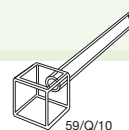

Type 46-F, 47-F, 71-F & 72-F. Fluorimeter flow cells

- Four polished windows.
- Profiled inlet/outlet blocks.
- Inlet/outlet tubes - 2 I.D, 4 O.D, 16mm long intended for push-on flexible tubing.
- TC Screw fittings see **Type No. MCTC/1.0**, page 29.
- For LTC Screw fittings see **Type No. LTC/G/0.5**, page 29.

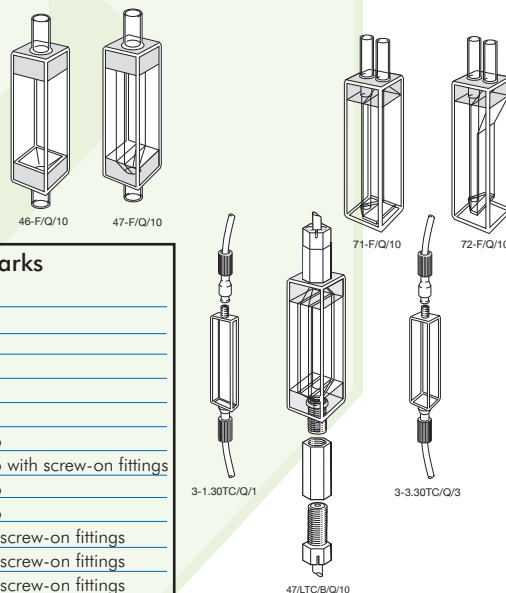

Type No.	Window Material	Path Length	Internal W	Internal H	External Height	Nominal Vol. ml	Polished Windows	Remarks
46-F	Q	0.5	10	35	65	0.185	4	Short path
46-F	Q	1	10	35	65	0.350	4	Short path
46-F	Q	2	10	35	65	0.700	4	Short path
46-F	Q	5	10	35	65	1.750	4	Short path
46-F	Q	10	10	35	65	0.350	4	Macro
47-F	Q	10	4	35	65	1.600	4	Semi-micro
47-F/LTC	Q	10	4	35	65	1.600	4	Semi-micro with screw-on fittings
71-F	Q	10	7	37.5	48	3.000	3	Semi-micro
72-F	Q	10	4	37.5	48	1.800	3	Semi-micro
3-1.30/TC	Q	1	1	30	40	0.030	4	Micro with screw-on fittings
3-2.30/TC	Q	2	2	30	40	0.120	4	Micro with screw-on fittings
3-3.30/TC	Q	3	3	30	40	0.270	4	Micro with screw-on fittings

Type 73-F. Fluorimeter flow cells

- Three polished windows.
- Inlet/outlet tubes - 2 I.D, 4 O.D, 16mm long intended for push-on flexible tubing.
- Cells with a Z height of 8.5mm have an overall height of 40mm.

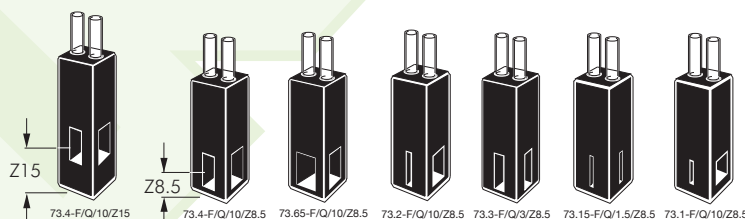

Type No.	Window Material	Path Length	Z Height	Internal W	Internal H	Emission window W	Emission window H	External Height	Nominal Vol.ml	Remarks
73.1-F	Q	10	8.5,15	1	11	10	11	45	0.010	Micro
73.2-F	Q	10	8.5,15	2	11	10	11	45	0.012	Micro
73.4-F	Q	10	8.5,15	4	11	10	11	45	0.040	Semi-micro
73.65-F	Q	10	8.5,15	6.5	11	10	11	45	0.045	
73.1.8-F	Q	1	8.5,15	1	8	11	8	45	0.080	Ultra-micro
73.15-F	Q	1.5	8.5,15	1.5	11	1.5	11	45	0.050	Micro
73.3-F	Q	3	8.5,15	3	11	3	11	45	0.100	semi-micro

Type 583-F. Fluorimeter flow cells

- Three polished windows.
- M6 screw-in connections.
- Cells with a Z height of 20mm have an overall height of 40mm.

Type No.	Window Material	Path Length	Z Height	Internal W	Internal H	Emission window W	Emission window H	External L	External W	External H	Nominal Vol.ml
583.2.2-F	Q	10	15, 20	2	2	7	2	12.5	12.5	35	0.040
583.4.2-F	Q	10	15, 20	4	2	7	2	12.5	12.5	35	0.080
583.1-F	Q	1	15	1	11	1	11	12.5	12.5	35	0.011
583.3-F	Q	3	15	3	11	3	11	12.5	12.5	35	0.100
583.4-F	Q	10	15	4	11	7	11	12.5	12.5	35	0.440

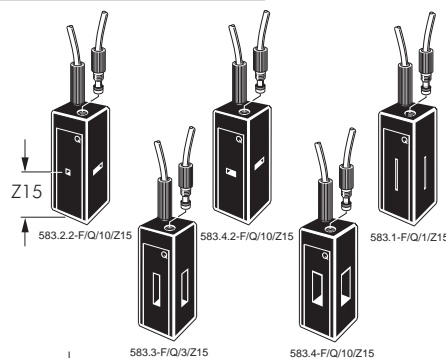

Type 73-F/SS & 583-F Fluorimeter flow cells, HPLC

- Three polished windows.
- Stainless steel inlet/outlet tubes.
- Type 73 cells with a Z height of 8.5mm have an overall height of 38.5mm.
- Type 583 cells with a Z height of 20mm have an overall height of 40mm.

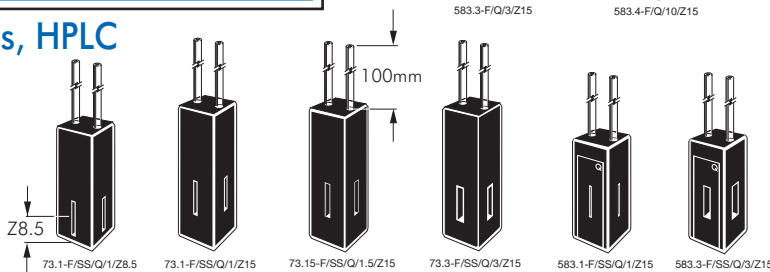

Type No.	Window Material	Path Length	Z Height	Internal W	Internal H	External L	External W	External H	Emission window W	Emission window H	Nominal Vol. ml	Stainless steel tubes				
												Inlet I.D.	O.D.	Outlet I.D.	O.D.	Length
73.1-F/SS	Q	1	8.5, 15	1	11	12.5	12.5	45	1	11	0.011	0.25	1.6	0.50	1.6	100
73.15-F/SS	Q	1.5	8.5, 15	1.5	11	12.5	12.5	45	1.5	11	0.025	1.0	1.6	1.0	1.6	100
73.3-F/SS	Q	3	8.5, 15	3	11	12.5	12.5	45	3	11	0.100	1.0	1.6	1.0	1.6	100
583.1-F/SS	Q	1	15, 20	1	11	12.5	12.5	35	1	11	0.011	0.25	1.6	0.50	1.6	100
583.3-F/SS	Q	3	15, 20	3	11	12.5	12.5	35	3	11	0.100	1.0	1.6	1.0	1.6	100

Type 61-F, 62-F, 63-F. Water-jacketed Fluorimeter cells

- Inlet/outlet tubes - 2 I.D, 4 O.D, 10mm long intended for push-on flexible tubing.
- Stopper length on 61-F and 62-F, 20mm.
- **Types 62-F and 63-F** have emission windows 4.5mm x 22mm long.
- Base window 4.5mm x 4.5mm.

Type No.	Window Material	Path Length	Internal W	Internal H	External Height	Nominal Vol. ml	Polished Windows
61-F	Q	10	7.0	37	48	2.59	3
62-F	Q	10	4.5	37	48	1.66	5
63-F	Q	10	4.5	37	48	1.66	5

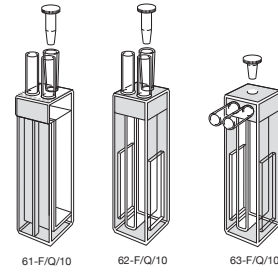

Type 61. Constant temperature with stopper Type 62 & 63. Constant temperature. Semi-micro Type 64. Constant temperature. Sub-micro

- Two polished windows.
- **Type 64** sub-micro for heating small samples typically DNA.
- **Type 64** with Z15 overall height 45mm.
- Inlet/outlet tubes - 2 I.D, 4 O.D, 10mm long intended for push-on flexible tubing.

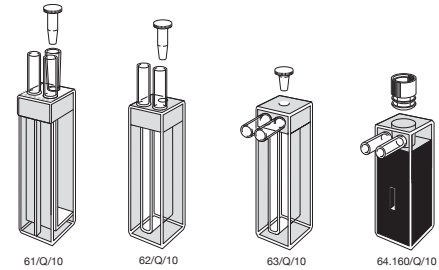

Type No.	Window Material	Path Length	Internal W	Internal H L	External W	External H	External Height	Overall Vol. ml	Nominal	Remarks
61	Q	10	7	37.5	12.5	12.5	48	60	2.100	Vertical flow tubes
62	Q	10	4.5	40	12.5	12.5	48	60	1.520	Vertical flow tubes
63	Q	10	4.5	40	12.5	12.5	48	60	1.520	Horizontal flow tubes
64.160	Q	10	2	8	12.5	12.5	38.5	40	0.160	Z Height - 8.5 or 15mm

Type 65. Cylindrical constant temperature, standard and short path length

- Two polished windows.
- Maximised surface area contact for temperature controlling medium throughout the range.
- Tubulations intended for push-on flexible tubing.
- Closed by PTFE stopper, providing a liquid-tight seal. (65 & 100mm cells have two stoppers).

Type No.	Window Material	Path Length	Internal Dia.	External Dia.	L	Overall Height	Nominal Vol. ml
65	Q	0.01	10	22	20	32	0.737
65	Q	0.1	10	22	20	32	0.747
65	Q	0.5	10	22	20	32	0.792
65	Q	1	10	22	20	32	0.849
65	Q	2	10	22	20	32	0.962
65	Q	5	10	22	20	32	1.300
65	Q	10	10	22	12.5	32	0.825
65	Q	20	10	22	22.5	32	1.650
65	Q	50	10	22	52.5	32	4.125
65	Q	100	10	22	102.5	32	8.250

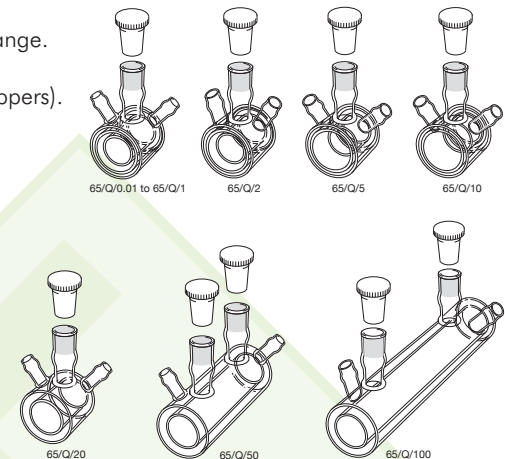

Type 410 & 411. Flow through. Refractometer

- Three polished windows.
- Inlet/outlet bores for each chamber via special holders supplied by instrument manufacturers together with connectors and tubing.

Type No.	Window Material	Path Length	Internal W	Internal H	External L	External W	External H	Nominal Vol. ml
410.03	SOG, Q	2.5	2.5	7	8	10	15	2 x 0.01
410.05	SOG, Q	2.5	2.5	7	8	10	15	2 x 0.01
410.10	SOG, Q	2.5	2.5	7	8	10	15	2 x 0.01
410.45	SOG, Q	2.6	2.6	7	8	10	15	2 x 0.01
411.45.1	SOG, Q	1	1	8	5.5	5	11	2 x 0.04
411.45.15	SOG, Q	1.5	1.5	8	5.5	5	11	2 x 0.09

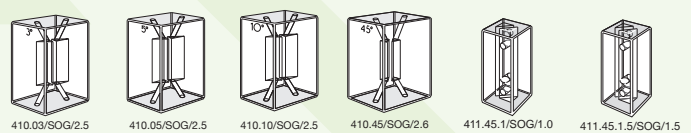

Magnetic stirring

- Rectangular cells have a well for magnet location.
- Micro and semi-micro cells have a conical profile in walls for better mixing.
- One stir bar is supplied with each cell.
- For spare stirring bars (see page 28).

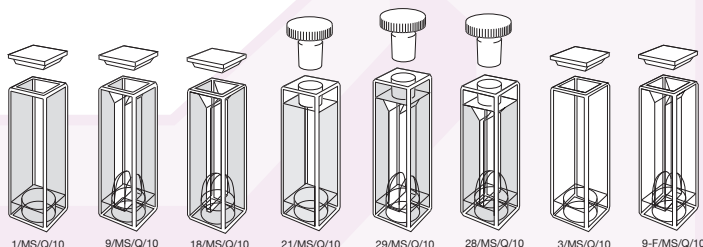

Type No.	Window Materials	Path Length	External			Nominal Vol. ml	Remarks
			L	W	H		
1/MS	SOG,Q	10	12.5	12.5	45	3.5	Macro
9/MS	SOG,Q	10	12.5	12.5	45	1.8	Semi-micro
18/MS	SOG,Q	10	12.5	12.5	45	0.9	Micro
21/MS	SOG,Q	10	12.5	12.5	48	3.5	Macro with stopper
29/MS	SOG,Q	10	12.5	12.5	48	1.8	Semi-micro with stopper
28/MS	SOG,Q	10	12.5	12.5	48	0.9	Micro with stopper
3/MS	SOG,Q	10	12.5	12.5	45	3.5	Macro fluorimeter
9-F/MS	Q	10	12.5	12.5	45	1.8	Semi-micro fluorimeter
18-F/MS	Q	10	12.5	12.5	45	0.9	Micro fluorimeter
23/MS	Q	10	12.5	12.5	48	3.5	Macro fluorimeter with stopper
29-F/MS	Q	10	12.5	12.5	48	1.8	Semi-micro fluorimeter with stopper
28-F/MS	Q	10	12.5	12.5	48	0.9	Micro fluorimeter with stopper

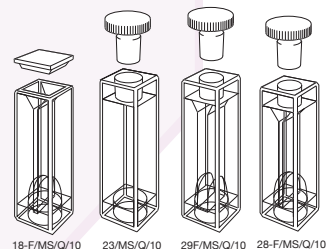

Type 39 Polarimeter. Standard and semi-micro, constant temperature

- Easy filling and emptying.
- Extended manufacturing process to ensure that they are free from birefringence effects which could affect the accuracy of measurements.
- Also available with two round windows, 39.35/2R and 39.105/2R.
- **Water jacketed 'WJ'** available Q only, 100 & 200mm Path length.

Type No.	Window Material	Path Length	Internal Dia.	External Dia.	L	Nominal Vol. ml
39.35	PX	10	4	6	14	0.098
39.35	PX	50	4	6	54	0.490
39.35	PX	100	4	6	104	0.980
39.105	PX	10	10	12	14	0.890
39.105	PX	50	10	12	54	4.350
39.105	PX	100	10	12	104	8.700
39.105/WJ	Q	100	10	12	104	8.700
39.105/WJ	Q	200	10	12	204	18.000

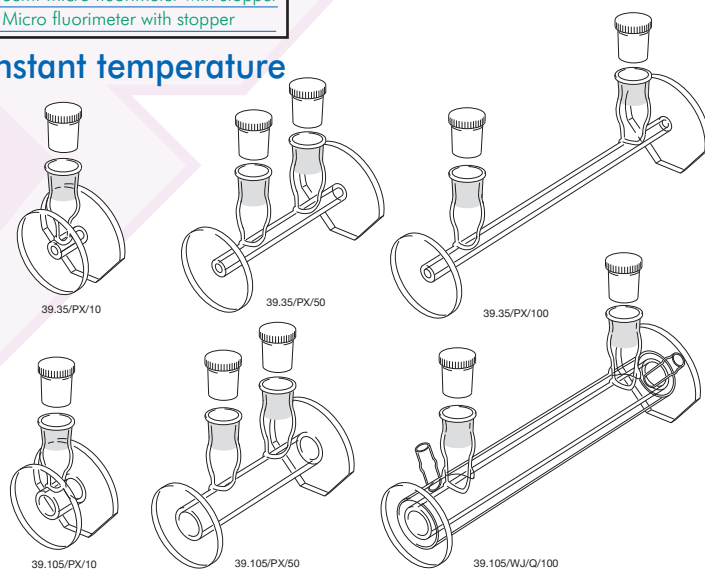

Type 300. Dye laser

- Dye laser cells are made with extreme accuracy having a surface flatness which extends all the way to the edge of the cell.
- Many of the fluorescent type of cells illustrated in this catalogue may be used for laser applications, however, to ensure their optical flatness, they are polished to more exacting tolerances.
- All **Type 300** cells have four polished walls and base except **300/Q/20** and **300/Q/40** which have a grey base.
- **Types 300/18.1/D, 300/28.1/D & 300/18.1/SBT15/D** have a diagonal sample compartment for front surface fluorescence.

Type No.	Window Material	Path Length	Internal Width	External L	External W	H	Nominal Vol. ml
300/3/ST	Q	10	10	12.5	12.5	45	3.500
300/3	Q	10	10	12.5	12.5	45	3.500
300/23	Q	10	10	12.5	12.5	48	3.500
300/29	Q	10	4	12.5	12.5	48	1.400
300/28.05	Q	10	0.5	12.5	12.5	48	0.175
300/28.1	Q	10	1	12.5	12.5	48	0.350
300/28	Q	10	2	12.5	12.5	48	0.700
300	Q	20	20	26	26	40	12.000
300	Q	40	20	46	26	40	24.000
300/18.1/D	Q	1		12.5	12.5	45	0.350
300/28.1/D	Q	1		12.5	12.5	48	0.350
300/18.1/SBT15/D	Q	1		12.5	12.5	59	0.350

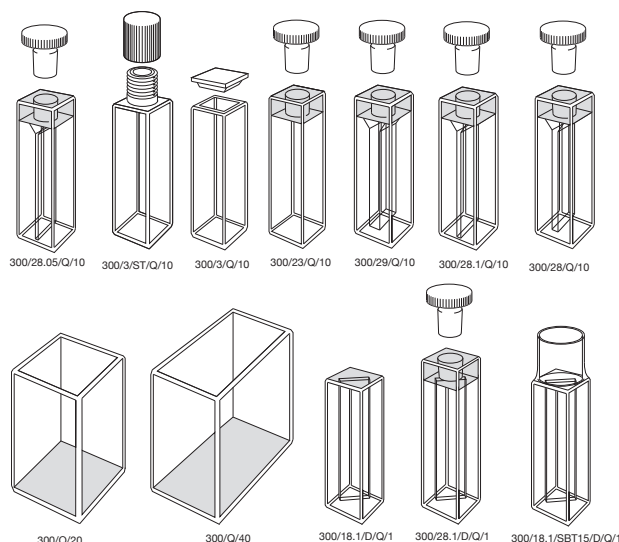

Type 93, 96, 97 & 98 Colorimeter/Absorption cells

- Two polished windows.
- U-shaped wall construction.
- Fully fused.

Type 93. Colorimeter

Type No.	Window Material	Path Length	Internal Width	External L W H			Nominal Vol. ml
93	G	2	50	6	55	56	5
93	G	5	50	9	55	56	12.5
93	G	10	50	14	55	56	25
93	G	20	50	24	55	56	50
93	G	30	50	34	55	56	75
93	G	40	50	44	55	56	100
93	G	50	50	54	55	56	125

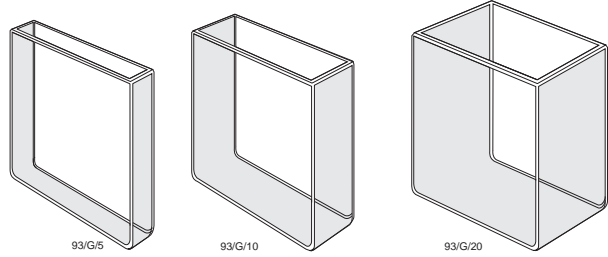

Type 96. Absorption or Colorimeter

- 96/MCB for Macbeth colorimeter.

Type No.	Window Material	Path Length	Internal Width	External L W H			Nominal Vol. ml
96	G	2.5	24	8.5	28	40	1.80
96	G	5	24	11	28	40	3.60
96	G	10	24	16	28	40	7.20
96	G	20	24	26	28	40	14.00
96	G	40	24	46	28	40	28.00
96	G	100	24	106	28	40	70.00
96/MCB	G	10	24	14	28	40	7.20

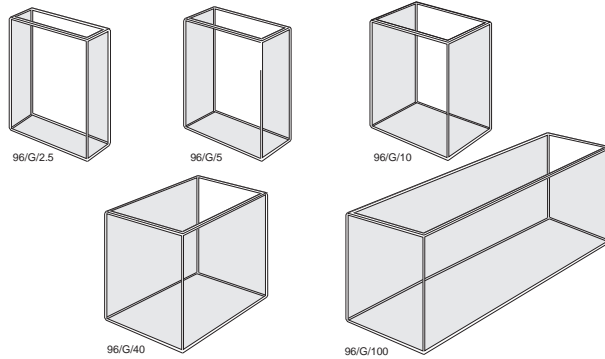

Type 97.40. Absorption or Colorimeter

Type No.	Window Material	Path Length	Internal Width	External L W H			Nominal Vol. ml
97.40	G	2.5	16	6.5	20	40	1.4
97.40	G	5	16	9	20	40	2.8
97.40	G	10	16	14	20	40	5.6
97.40	G	20	16	24	20	40	11.20
97.40	G	40	16	44	20	40	22.40
97.45	G	40	16	44	20	45	25.60
97.40	G	50	16	54	20	40	28.00
97.40	G	100	16	104	20	40	56.00

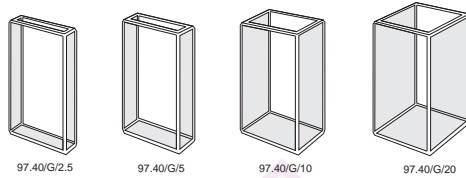

Type 97.60 Absorption or Colorimeter

Type No.	Window Material	Path Length	Internal Width	External L W H			Nominal Vol. ml
97.60	G	2.5	16	6.5	20	60	1.60
97.60	G	5	16	9	20	60	3.20
97.60	G	10	16	14	20	60	6.40
97.60	G	20	16	24	20	60	12.80
97.60	G	40	16	44	20	60	25.16
97.60	G	50	16	54	20	60	32.00
97.60	G	100	16	104	20	60	64.00

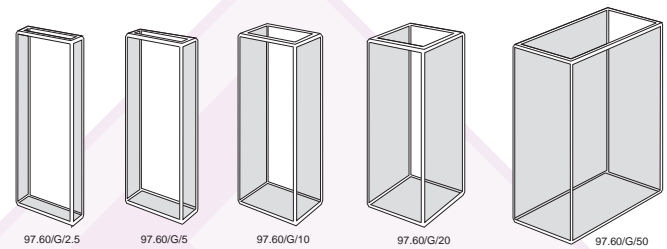

Type 98. Absorption or Colorimeter

Type No.	Window Material	Path Length	Internal Width	External L W H			Nominal Vol. ml
98	G	2.5	12	8.5	18	40	1.20
98	G	5	12	11	18	40	2.40
98	G	10	12	16	18	40	4.80
98	G	13	12	19	18	40	6.24
98	G	15	12	21	18	40	7.20
98	G	20	12	28	18	40	9.60
98	G	25	12	31	18	40	12.00
98	G	30	12	36	18	40	14.40
98	G	33	12	39	18	40	15.85
98	G	40	12	46	18	40	19.20

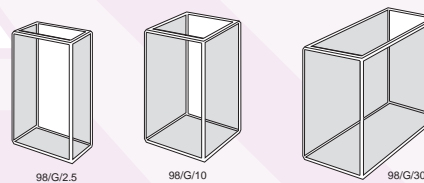

Type 100. Gel boat cells

- Two polished windows.
- Open top, no lid.

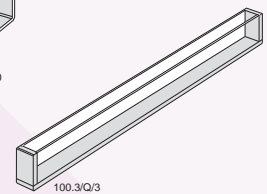

Type No.	Window Material	Path Length	Internal W H		External L W H		
100.3	Q	3	3	10	104	6	12
100.5	Q	5	5	10	100	7.5	10.5
100.6	Q	6	6	10	104	10	12
100.7	Q	7	7	10	104	11	12
100.8	Q	8	8	10	104	12	12

Cell holder, short path length

The cell holder **Type CH/2049** is designed for use with **Types 20 & 49** with path lengths of 3mm or less. Exterior dimensions are 12.5 x 12.5 x 52mm.



Type No.	Description
CH/2049	Cell holder, short path length

Cell holder, long path length

Cell holders **Type CH/50** and **CH/100** are for rectangular cells up to 50mm and 100mm path lengths respectively. The **CH/34/100** fits 50mm or 100mm **Type 34**. All are complete with a 75mm x 50mm back plate to fit standard infrared instrument holders.

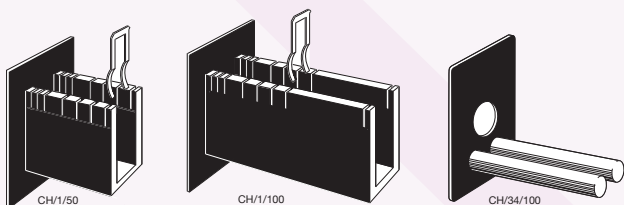

Type No.	Description
CH/1/50	Up to 50mm cell holder
CH/1/100	Up to 100mm cell holder
CH/34/100	50/100mm T34 holder

Cell compartment spacers

Aluminium spacers, black anodised, available in three sizes for use with 1, 2, and 5mm path length cells, supporting them in a 12.5 x 12.5mm holder where there is no cell holder path length adjustment facility.

Type No.	Description
SPA/1	for 1mm path length cells
SPA/2	for 2mm path length cells
SPA/5	for 5mm path length cells

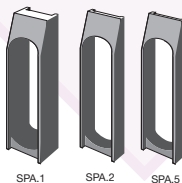

Magnetic stir bars

PTFE coated magnetic stir bars, available in packs of ten to fit the MS range of cells illustrated on page 26 of this catalogue.

Types 18/MS and **28/MS** need the **MSB/6x1.5** to allow the stirring bar to enter the narrow sample compartment.

Type No.	Dimensions
MSB/5x2/10	5mm long x 2mm diameter
MSB/6x1.5/10	6mm long x 1.5mm diameter
MSB/6x3/10	6mm long x 3mm diameter



Quartz block inserts

Precision polished Far UV quartz inserts are intended for use with Standard Rectangular 10mm path length cells (see page 5), when a reduced path length is required without using a different cell. Four size combinations, each provide two different path lengths as indicated, by rotating the insert through ninety degrees.

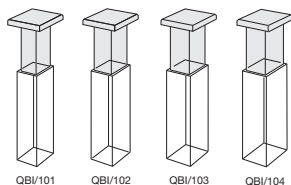

Type No.	Path length	External L	W	H
QBI/101	1 or 5	9	5	48
QBI/102	1 or 2	9	8	48
QBI/103	1 or 0.5	9	9.5	48
QBI/104	1 or 0.05	9	9.95	48

Cell lids

Cell lids are available in PTFE up to 100mm long. Vaned polyethylene lids for 10mm rectangular cells only. Lids for large rectangular cells manufactured to special order.

Types 1 & 3	9	18
LID/1.001	LID/9.001	LID/18.001
LID/1.002	9.002	18.002
LID/1.005	9.005	18.005
LID/1.010	9.010	18.010
LID/1.010V		
LID/1.020	9.020	18.020
LID/1.040	9.040	18.040
LID/1.050	9.050	18.050
LID/1.100	9.100	18.100

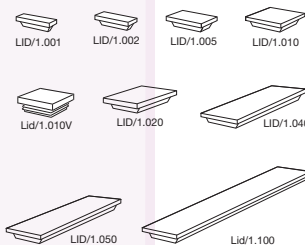

Stoppers

Spare stoppers for all cells require cell type identification. The most common types are shown in the table below

Type No.	To fit
STP/C2.5	23-1.45, 2.45, 3.45
STP/C5	23-4.45, 318, 21, 23 (5mm or less), 23-5.45
STP/C5L	62, 63
STP/C7	28, 29, 32 (up to 10mm)
STP/C10	21, 21N, 23
STP/C10L	34, 32 (over 10mm)
STP/C10.LHS/Z8.5	26/LHS/Z8.5
STP/C10.LHS/Z15	26/LHS/Z15 or Z20
STP/C10.10V	16R

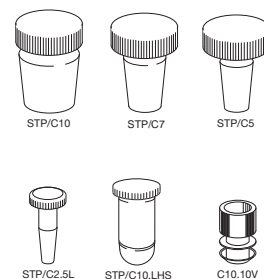

Caps, closed & septum

Screw caps to fit GL14 or ST threaded tops available as either fully closed cap or septum seal cap.

Type No.	Description	Dia.	Height	Remarks
GL/14C/PTFE	Closed cap	20mm	17mm	PTFE/WHITE
GL/14C/PBT	Closed cap	20mm	17mm	PBT/RED
GL/14S/PTFE	Septum cap	20mm	17mm	PTFE/WHITE
GL/14S/PBT	Septum cap	20mm	17mm	PBT/RED
GL/14C/PTFE/SPF	Closed cap, PTFE Faced Silicone Seal			
ST/C	Closed cap	12mm	12mm	
ST/S	Septum cap	12mm	12mm	
GL/14/SEAL/S	Cap or Septum seal Silicone			Pack of 10
GL/14/SEAL/SPF	Cap or Septum seal Silicone/PTFE Face			Pack of 10
ST/SEAL/S	Cap or Septum seal Silicone			Pack of 10
ST/SEAL/PT	Cap or Septum seal Nitrile/PTFE Face			Pack of 10

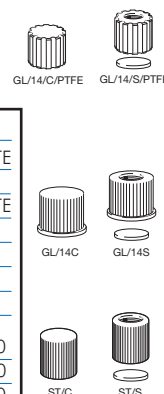

Anti-reflection & mirror coatings

Some fluorescent applications require either or both the excitation and emission energy to be enhanced by applying a metallic mirror coating to the outside of adjacent windows opposite to the source and the detector windows. Similarly, anti-reflection coatings on the other windows reduce reflective losses. Each suffix indicates coating for two adjacent walls per cell and is priced accordingly in the price list.

Type No.	Description
/AR	Anti-reflection coating
/MC	Mirror coating
/AR/MC	Anti-reflection & mirror coating

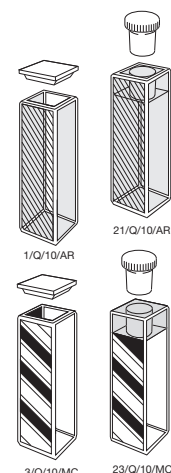

Fittings for 583, 584 & 585 Series cells

Universal single-ended connectors

- One pair of gripper fittings, M6 thread, consisting of one long and one short connector, single-ended.
- Each fitting comes with 1,5 metre of tubing as standard, other lengths available on request.
- PTFE tube is standard, 1.6mm O.D, 1mm I.D. FEP available on request.

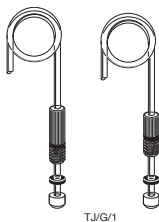

TJ/G/1

Type No.	Description
TJ/G/1.5/PTFE	Pair of connectors, PTFE tube
TJ/G/1.0/FEP	Pair of connectors, FEP tube

Universal adaptors, screw fitting to flexible tubing

- Supplied in pairs, to convert M6 and 1/4 screw thread 28TPI.
- Suitable for using push-on flexible silicone tubing or similar with a range of internal diameters from 1mm to 3.5mm.

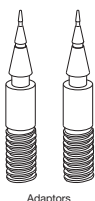

Adaptors

Type No.	Description
TJ/G/038	Pair of barbed adaptors for M6 thread
LTC/G/0.5	Pair of barbed adaptors for 1/4 x 28

Fittings for TC external Quartz threads

- To fit male threaded quartz tubes fully fused to the cell.
- PTFE flange, ferrule and cap to screw onto the male thread, single ended.
- Each tube one metre length standard, 1.6mm O.D, 1mm I.D. Other lengths available on request.

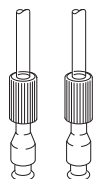

MCTC 1.0

Type No.	Description
MCTC/1.0	Pair of connectors, PTFE tube & collar.

Fittings for LTC external Quartz threads

- For use with 1/4 28TPI male thread fully fused to the cell.
- PTFE collar, gripper fitting.
- Each tube one metre length standard, 1.6mm O.D, 1mm I.D. Other lengths available on request.

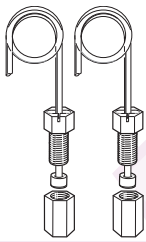

LTC/0.5

Type No.	Description
LTC/0.5	Pair of connectors, PTFE tube

Varian C50 Dissolution connector spares kit

- One pair of gripper fittings, one long double-ended with M6 thread, to 1/4 28TPI female and one short double-ended with M6 thread, to 1/4 28TPI female.
- Each tube 30cm long between connectors.
- Clear PTFE tube standard coloured PTFE tubing available in following colours: Blue, Brown, Green, Natural, Purple, Red, White, Yellow.

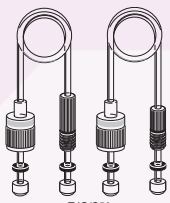

TJG/C50

Type No.	Description
TJ/G/C50	Pair of connectors, PTFE tube
TJ/G/C50x4	Four pairs of above, colours to be specified
TJ/G/C50x8	Eight pairs of above, one pair of each colour
TJ/G/C50x9	Set of 9 single dual path length inter-connecting tubing kit

Varian C100 Dissolution connector spares kit

- One pair of gripper fittings, one long double-ended with M6 thread, to 1/4 28TPI male and one short double-ended with M6 thread, to 1/4 28TPI male.
- Each tube 21cm long between connectors.

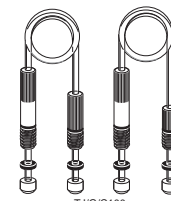

TJG/C100

Type No.	Description
TJ/G/C100	Pair of connectors, PTFE tube
TJ/G/C100x9	Set of 9 single dual path length inter-connecting tubing kit

Luerlock Adaptor spares kit

- One Luerlock adaptor for use with syringe.
- One screw fitting for overflow or to waste. Note: Syringe not included.

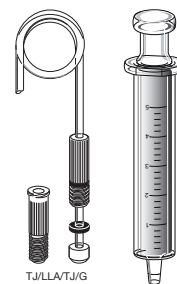

TJ/LA/TJ/G

Type No.	Description
TJ/LA/TJ/G	One Luerlock adaptor
	One screw fitting with tube

Starna Optical Polishing Cloth

The Starna lint-free Optical Polishing Cloth is specifically for use with Starna Liquid Reference Materials sealed into quartz cells where the optical windows need to be kept scrupulously clean for all valuation procedures. It may also be used for cleaning most types of normal glass and quartz cell windows but is not intended for use with any type of glass or metal on quartz filter.



Type No.	Description
CellClean/OPC	Lint-free Optical Polishing Cloth 25cm sq.

Starna® CellClean

Scrupulously clean glass or quartz cells are essential for consistent analytical results in all photometric disciplines. Starna® CellClean is an aqueous based cleaner with a unique combination of ingredients and provides cleaning actions that are able to lift, disperse, emulsify, sequester, dissolve, suspend or decompose. It may be used to remove oil, grease, resin, tar, wax, biological materials, insoluble oxides, fine particles and many other contaminants.

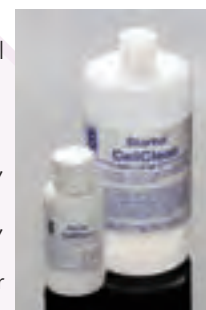

Type No.	Description
CellClean/150ml	Cell cleaner 150ml
CellClean/1000ml	Cell cleaner 1000ml

Funnels

Plastic or glass funnel suitable for use with aspiration cells **Types 25, 28-AS and 29-AS**. Funnel has approximate diameter of 30mm.



FUN/P/30

Type No.	Description
FUN/P/30	Plastic funnel 30mmø
FUN/G/30	Glass funnel 30mmø

'Spinette' cell stirrer

'Spinette' cell stirrers offer the ability to simultaneously measure and stir the contents of specially designed cells (MS), see page 26. Mixing of solutions is with a tiny magnetic stir bar placed into a purpose made well at the bottom of the cell. A small electronic coil rotation assembly is placed under the cell in the sample compartment. This raises the cell by 5mm which, without affecting instrument operation may also reduce the required sample volume. The 'Spinette' will fit all standard spectrophoto meters cell holders.

The speed of rotation can be adjusted with the controller which is connected to the electronic magnet by thin ribbon wire one metre in length. This will not interfere with insertion or removal of cells from the sample compartment and will also allow instrument covers to close normally.

Magnetic stir bars are available to fit the specially designed MS range of cells with 'stirring wells' depicted on page 26.

When purchasing stir bars separately for use with micro cells, the correct size must be selected. One stir bar is included with each MS cell. Typically, a cell filled with aqueous solution up to 30mm from the base, may be fully mixed within five seconds. The Spinette cell stirrer is supplied complete with speed controller, electronic rotation platform, ribbon wire and one stir bar. There are two models available, one with input voltage of 110 VAC and the other 220/240 VAC, see below.



Type No.	Description
SCS1.22	Spinette cell stirrer 240 VAC
SCS1.11	Spinette cell stirrer 110 VAC

Ultra High Vacuum (UHV) cells

- Designed for use in vacuums $<10^{-9}$ Torr
- Windows polished to $\lambda 10$ per cm^2 .
- Fully heat fused
- Far UV synthetic quartz or borosilicate.
- 20/10 scratch & dig.



A wide variety of UHV cells are produced. Used for quantum mechanics experimentation including Bose Einstein condensate experiments. Multilayer 'V', 'W' or broadband coatings available for specific wavelengths.

Type No.	Window Materials	Typical dimensions	
		Internal	External
UHV	Q	20 x 20 x 97	26 x 26 x 100
UHV	Q	24 x 24 x 97	30 x 30 x 100
UHV	Q	30 x 30 x 96	38 x 38 x 100

Custom sizes can be manufactured to special order. Dimensions should be specified when ordering, internal or external. Borosilicate materials may be used for UHV cells when dimensions allow.

Fluorescent reference materials

Molecular fluorescence spectroscopy is a sensitive and often selective technique. Unlike absorption spectrophotometry it is not an absolute technique: instruments therefore require calibration before every series of measurements. This may be achieved using a stable reference material, which should absorb and emit at similar wavelengths to the samples of interest. Use of the general purpose fluorescent reference material set type 6BF enables the day to day stability of instruments to be measured.

The 6BF reference materials are not standards with absolute values, but a set of six relatively stable fluorescent materials in a polymethylmethacrylate matrix with which the stability and precision of the instrument can be monitored. Four blocks exhibit broad band spectra which cover the normally used UV and visible region of the spectrum, with considerable overlap. Two blocks contain materials suitable for illustrating the selectivity of the technique as well as checking instrument resolution and wavelength calibration. The materials have the following advantages:

- Stability:** no degradation, no evaporation.
- Safety:** no chemicals to mix.
- Robust:** unbreakable, easy to store and use.

Further information can be found in the **Starna®** booklet entitled: "Reference Materials for Molecular Fluorescence Spectrophotometry"

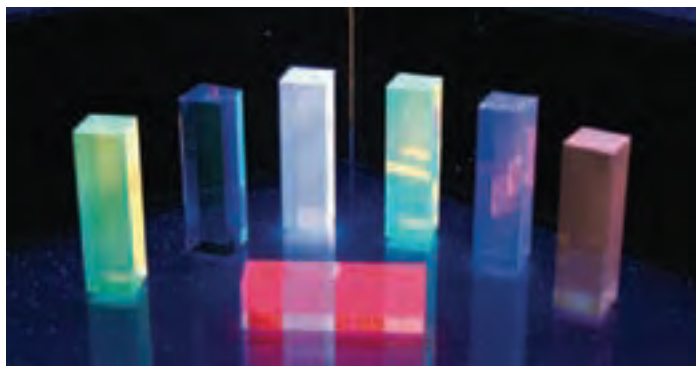

Also available in permanently flame-sealed cells are the following references for fluorimeter applications.

Quinine Sulphate [RM-QS]

solution in sealed cells for fluorescent instrument qualifications.

Rhodamine [4-TB/Rhodamine/101]

flame-sealed into triangular cells for quantum yield and spectral correction.

Water cell [3/Q/10/Water]

suitable for Raman Band signal to noise determination.

Instrument validation

NIST Traceable Glass & Liquid References

***Starna** are a world leading manufacturer and supplier of **Certified Reference Materials [CRMs]** for UV, Visible and Near Infrared photometer applications. All CRMs are manufactured to **ISO 17025 & ISO Guide 34** in the **Starna UKAS accredited laboratory**.

***Starna** CRMs meet all current international regulatory validation requirements for UV, Visible and Near Infrared spectrophotometer instruments.

*Glass filter CRMs are manufactured to the exacting standards required by **National Metrology Institutes [NMIs]**.

*All Starna liquid references are heat fusion-sealed, eliminating both contamination and leakage issues. Starna has forty years experience in the production of heat fusion - sealed references.

*A **Lifetime Guarantee** covers all Starna UKAS Certified references, provided the CRMs are re-certified at least every two years and are used in compliance with the conditions of use, stated in the documentation enclosed with each set.

***Re-calibration service** with a guaranteed five working day turn-round is available from the Starna Calibration Laboratory, for all references. Some third party references can also be certified to ISO 17025 standard.



Below are some typical set designations to meet various regulatory requirements.

Full details of all references are available from Starna.

European Pharmacopoeia - RM-0660HLKCTX

Potassium Dichromate 60 & 600mg/l, Holmium Perchlorate, Potassium Chloride, Toluene/Hexane

Full Pharmacopoeia - RM-0660HLKCSITX

Potassium Dichromate 60 & 600mg/l, Holmium Perchlorate, Potassium Chloride, Sodium Iodide, Toluene/Hexane

United States Pharmacopoeia (USP) - RM-06HLKITX

Potassium Dichromate 60mg/l, Holmium Perchlorate, Potassium Iodide, Toluene/Hexane

RM-06 Potassium Dichromate 60mg/l

RM-HL Holmium Perchlorate

RM-1N2N3N Neutral Density Filter 10, 20 & 30%T

RM-N1N35N Neutral Density Filter 1, 3 & 50%T

RM-NIR TS5 Reference



Absorbance & Linearity



Wavelength



Stray Light



Instrument Resolution

Terms of Sale

Normal terms of sale are net 30 days, FOB Hainault to authorised accounts. Under our terms of sale 'Title of ownership of any goods shipped does not transfer until the goods have been paid for in full'.

Product Warranty

Starna® Spectrophotometer and Fluorimeter cells are warranted to meet the specifications shown on page 2 of this catalogue and be equal to or better than the dimensional tolerance for each cell listed. Stringent quality control is exercised throughout production with only guaranteed and brand named raw materials used, so that cells will perform to the highest specification for any given design.

Any goods to be returned under warranty require a Return of Merchandise Authorisation (RMA) number, which can be obtained by calling our Customer Service Department.

We reserve the right to change the design or specification of any product without prior notification.

Technical Information

Technical staff are available to assist in the selection of cell material or physical configuration to satisfy individual applications.

Method of shipment

Prices do not include shipping costs, duty or tax. Normal shipment, unless otherwise specified, is by recorded letter or parcel post. Overnight service is available via Courier or Data Post. Overseas shipments utilise Air parcel or letter post, UPS, TNT, DHL, FedEx or regular air freight. Unless specified otherwise all shipping charges are prepaid and added to the sales invoice.

Stock items

Great efforts are made to stock the widest possible range of products for immediate shipping.

Any item temporarily out of stock will be back ordered to our own production facility and shipped at the earliest possible opportunity unless otherwise instructed.

All rights reserved. No part of this publication may be reproduced, stored in a retrieval system, or transmitted, in any form or by any means, electronic, mechanical, photocopying, recording or otherwise, without the prior permission of Starna Scientific Ltd.

First published 1972. Revised 1978, 87, 91, 95, 01 & 03. This edition UK 09/10. The copyright © of this catalogue is held by the Starna® group of companies.

Starna Scientific Limited

52-54 Fowler Road,
Hainault, Essex
IG6 3UT, UK

Starna Scientific Sales
& Technical Assistance
Tel: +44 (0)20 8501 5550
Fax: +44 (0)20 8501 1118
Email: sales@starna.com
www.starna.com



Starna scientific

Starna Cells Inc.

PO Box 1919
Atascadero
CA 93423
USA
Tel: 800 228 4482
805 466 8855
Fax: 805 461 1575
Email: info@starnacells.com

Starna Pty. Ltd.

PO Box 6751
Baulkham Hills BC
NSW 2153
AUSTRALIA
Tel: 61-2-9659 8088
Fax: 61-2-9659 8511
Email: info@starna.com.au

Starna GmbH

Postfach 1206
D-64311
Pfungstadt
GERMANY
Tel: +49 (0) 6157 2813
Fax: +49 (0) 6157 85564
Email: starna@t-online.de

Local Distributor