

We provide information and advice to our customers on application technologies and regulatory matters to the best of our knowledge and ability, but without obligation or liability. Existing laws and regulations are to be observed in all cases by our customers. This also applies in respect to any rights of third parties. Our information and advice do not relieve our customers of their own responsibility for checking the suitability of our products for the envisaged purpose.

Amberjet®, Amberlite®, Amberlyst® and Triton® are registered trademarks of Rohm and Haas Co.; Avicel® is a trademark of FMC Corp., Philadelphia; Dowex® is a registered trademark of the Dow Chemical Co.; Florisil® is a registered trademark of U.S. Silica Company (www.u-s-silica.com); LaChrom® is a registered trademark of VWR International, Hitachi Ltd and Hitachi High-Technologies Corp.; Luer-Lok® is a registered trademark of Becton Dickinson; UPLC® is a registered trademark of Waters Corporation. Fluoropore™ is a trademark of Merck KGaA, Darmstadt, Germany. A10®, Aluspher®, CapRod®, ChiraDex®, Chromolith®, Durapore®, Elix®, E-POD®, EXTrelut®, Geduran®, Hibar®, Jetpore®, LC-Pak®, LiChroCART®, LiChrolut®, LiChroprep®, LiChropur®, LiChrosolv®, LiChrosorb®, LiChrospher®, LiChroTest®, LuxPlate®, manu-CART®, Millex®, Millex Smplicity®, Millipak®, Millipore Express®, Millitrack®, Milli-Q®, Milli-Q® Advantage, Omnipore®, PharmPrep®, Prepsolv®, Progard®, ProteoChrom®, Purospher®, Q-Gard®, Q-POD®, Quantum®, Smplicity®, SeQuant®, Superspher®, SupraSolv®, UniSolv®, ZIC®-HILIC, ZIC®-CILIC and ZIC®-pHILIC are registered trademarks of Merck KGaA, Darmstadt, Germany.



ChromBook

ChromBook

The world of chromatography in your hands

Merck Millipore is a division of  MERCK



For further information on Merck Millipore and our products contact:

Merck KGaA
64271 Darmstadt, Germany
E-mail: chromatography@merckgroup.com
www.merckmillipore.com/chromatography

Learning Center

Nonstop advances in chromatography

Merck Millipore's chromatography portfolio is based on a simple but powerful principle: constant progress. Since the development of the first aluminum oxide for adsorption chromatography in 1904, to the state-of-the-art solutions of today, we have been creating superior tools and technologies to solve our customers' challenges.

Our innovative solutions and uncompromising quality have made Merck Millipore's chromatography products the most widely used around the world. We are proud to be one of the leaders in liquid chromatography, and continue to push the boundaries with our sorbents, columns, and products for sample preparation, thin layer chromatography and biochromatography.

Our website offers unlimited access to expertise on demand – so you have all the resources you need to succeed in chromatography.

- Education Material: Insightful presentations and practical tips on basic and advanced analytical chromatography technologies
- Events: Information about upcoming symposia and exhibitions
- Literature: All of our brochures in one place
- Manuals: Complete instructions for all our chromatography products
- Videos & Webcasts: Valuable advice on products and applications
- Scientific Posters: Help at a glance for your daily chromatography work



www.merckmillipore.com/chromatography-learning

Merck Millipore's passion for progress is not only evident in our breakthrough products, but also reflected in our personalized service and supportive tools. This new edition of the ChromBook catalog is a perfect example. It is a rich source of information, with complete details about our entire chromatography portfolio, as well as valuable advice about modern methods and applications.

To further support your work, we have also developed convenient ChromBook apps for desktop and mobile use. Be it in the lab, field or factory, the apps give you quick access to all of our products for TLC, HPLC, UHPLC, GC, and sample preparation, as well as related solvents. Together, the ChromBook catalog and app are designed to be your ideal companions for successful analysis.

Whether for research and development, quality control or purification, we keep our products ahead of the times to keep you ahead in your field. Are you ready to advance together? Let's go!

Access the free ChromBook app

For desktops: www.chrombook-app.com

For tablets:



ChromBook at a glance

01	Mobile Phases & Reagents	14
<p>Merck Millipore's LiChrosolv® and Prepsolv® high purity HPLC solvents ensure excellent separation results. Thanks to their unique packaging and withdrawal systems, they are also safer to handle. Our Lab Water Systems provide the best water quality – on demand.</p>		
02	Sample Preparation	44
<p>Our top quality portfolio of sample preparation products includes EXtrelut® for liquid-liquid extraction, LiChrolut® for solid-phase extraction, LiChrospher® ADS for on-line sample preparation, as well as Millex® and Samplicity® for sample filtration.</p>		
03	Thin Layer Chromatography	94
<p>TLC and HPTLC products from Merck Millipore combine outstanding quality with maximum convenience for a broad spectrum of applications.</p>		
04	Analytical HPLC	140
<p>Merck Millipore's HPLC and UHPLC products deliver highly reliable and reproducible separations – even for the most challenging analyses. Our diverse portfolio includes: Chromolith® monolithic columns; Purospher®, Superspher®, LiChrospher® and LiChrosorb® particulate columns; SeQuant® ZIC®-HILIC zwitterionic columns, as well as specialty sorbents.</p>		
05	Preparative HPLC	400
<p>Our broad portfolio of standardized sorbents for preparative HPLC offers a high degree of method reliability, direct transfers from analytical scale, and optimized throughput per time.</p>		
06	Ion Chromatography	432
<p>For enhanced detectability and simpler analysis in suppressed ion chromatography, Merck Millipore has developed the SeQuant® SAMS membrane suppressor, which is operated using the SeQuant® CARS continuous regeneration system.</p>		
07	Gas Chromatography	440
<p>For accurate, reliable and reproducible results in gas chromatography, Merck Millipore supplies a wide range of high-purity solvents (SupraSolv®, UniSolv®), sorbents, derivatization reagents, and standards.</p>		
08	Service	462
<p>Through our comprehensive ChromBook, interactive online tools, and dedicated service teams, Merck Millipore provides all the support you need to succeed in chromatography.</p>		

The chromatography products from Merck Millipore are not intended for use as medical devices for in-vitro diagnostic testing of human specimens within the meaning of European Directive 98 / 79 / EC. They are for research purposes only, for investigating in-vitro samples without any medical objective.



www.merckmillipore.com/chromatography

Visit our websites for:

- Applications
 - Technical information
 - Current chromatography topics
 - Educational material
 - Ordering products
- ... and much more!



Mobile Phases & Reagents for HPLC and TLC	page 17
LiChrosolv®	page 18
Solvents for analytical chromatography	
LiChrosolv® hypergrade	page 24
A new standard in HPLC solvents	
Prepsolv®	page 28
Solvents for preparative chromatography	
Solvent Management System	page 29
Solvents handling in bottles	page 30
Options for solvents handling in barrels	page 33
Lab Water Purification	page 37
Production of ultrapure water suitable for HPLC	
Elix® Advantage system	page 40
Tap to pure water	
Milli-Q® Advantage A10® system	page 41
Pure to ultrapure water	
Milli-Q® Integral system	page 42
Tap to pure & ultrapure water	
LiChropur® reagents for analytical HPLC	page 43

Sample Preparation	page 48
EXtrelut® NT working principle	page 50
Liquid-liquid extraction in its most effective form	
EXtrelut® NT1, EXtrelut® NT3 and EXtrelut® NT20	page 51
EXtrelut® NT refill packs and bulk materials	page 52
EXtrelut® NT accessories	page 53
Important EXtrelut® NT extraction parameters	page 54
LiChrolut®	page 56
LiChrolut® selection guide	page 57
LiChrolut®	page 58
Solid-phase extraction (SPE) with LiChrolut® – the reliable and rapid route to successful sample preparation	
LiChrolut® EN	page 60
Highest capacity for solid-phase extraction	
LiChrolut® extraction unit and drying attachment	page 64
LiChrolut® operating principle	page 65
LiChrospher® ADS	page 66
LiChrospher® ADS	page 68
For direct on-line sample preparation of untreated bio-fluids	
LiChrospher® ADS working principle	page 70
Ion exchangers and working principle	page 74
Application guide	page 75
Ion exchangers	page 76
Millex® Syringe Filters	page 80
Filter with confidence	
Millex® Syringe Filters	page 81
Sample preparation for chromatography	
Membrane Filters	page 84
Mobile phase preparation for HPLC/UHPLC	
Millex® Syringe Filters	page 85
Sample preparation for HPLC/UHPLC	
Millex® Syringe Filters	page 88
Automation-compatible filter	
Samplicity® Filtration System	page 90
Break free from routine sample filtration	
Samplicity® Filtration System	page 92
Now you can truly do more with less.	

Thin Layer Chromatography _____	page 97
Classical silica TLC plates (TLC) _____	page 98
For versatile and reliable routine analysis of a broad range of substances	
Aluminium oxide TLC plates _____	page 101
For basic and neutral compounds using different pH conditions	
Kieselguhr and mixed layer plates _____	page 102
For specific applications	
High performance silica plates (HPTLC) _____	page 103
For fast analysis of complex samples for manual or instrumental use	
LiChrospher® HPTLC _____	page 106
For fast analysis of complex samples for manual or instrumental use	
RP-modified silica plates (TLC and HPTLC) _____	page 108
Free choice of solvent system for special separations and as pilot method for HPLC	
CN-, Diol- and NH ₂ -modified plates (TLC and HPTLC) _____	page 111
For special separation problems	
Cellulose TLC and HPTLC _____	page 113
For analysis of polar substances	
PEI (Polyethylenimine) Cellulose _____	page 115
For specific separations by ion-exchange chromatography	
Concentrating zone plates (TLC, HPTLC, PLC) _____	page 116
Quick and easy sample application even of large volumes of diluted samples	
ProteoChrom® HPTLC plates _____	page 119
For peptide analysis	
TLC silica gel 60G plates _____	page 122
Highly robust plates with gypsum as binder, fully compliant with international pharmacopeia	
Multiformat plates (TLC and HPTLC) _____	page 124
Multiple sizes in one single glass plate	
GLP plates (TLC and HPTLC) _____	page 125
With individual laser coding for GLP applications	
TLC and HPTLC MS-grade plates for mass spectrometry _____	page 126
Preparative layer plates (PLC) _____	page 132
For enrichment of target analytes in mg quantities and sample clean-up	
Bulk sorbents for preparation of TLC plates _____	page 133
Standardized sorbents for reliable results	
Accessories _____	page 135
Technical appendix _____	page 136

Analytical HPLC _____	page 146
Method development & optimization _____	page 148
Pharmacopeial requirements _____	page 174
Column selection guide _____	page 188
Chromolith® _____	page 200
Speed and performance based on revolutionary monolithic silica technology	
Chromolith® CapRod® _____	page 201
Monolithic capillary	
Chromolith® HPLC columns _____	page 206
Speed and performance in monolithic form	
Chromolith® RP-18 endcapped _____	page 214
Chromolith® RP-18 endcapped columns are the fastest C18 columns in the world.	
Chromolith® RP-8 endcapped _____	page 230
Chromolith® Phenyl _____	page 232
Chromolith® CN _____	page 234
Chromolith® DIOL _____	page 236
Chromolith® Si _____	page 238
Chromolith® NH ₂ _____	page 240
Chromolith® guard cartridges and cartridge kits _____	page 243
Chromolith® column coupler _____	page 248
Chromolith® SemiPrep _____	page 250
Perfect scale-up from analytical to preparative LC	
Chromolith® Prep _____	page 254
Chromolith® – increase in speed, efficiency and productivity	
Purospher® _____	page 262
The all-round high performance solution for complex HPLC separations	
Purospher® STAR RP-18 endcapped _____	page 269
The versatility you need!	
Purospher® STAR RP-8 endcapped _____	page 283
Ideal for less hydrophobic compounds	
Purospher® STAR Phenyl _____	page 286
Enhanced selectivity for aromatic compounds	
Purospher® STAR Si (Silica) and NH ₂ (Amino-phase) _____	page 289
Purospher® STAR UHPLC columns for ultra fast HPLC _____	page 292
Where speed meets performance	
Purospher® STAR columns for LC-MS applications _____	page 299
Purospher® RP-18 endcapped _____	page 302
Excellent peak symmetry with either basic or strongly acidic compounds	
Purospher® RP-18 _____	page 304
Polar endcapped column material	
Purospher® RP-18 HC _____	page 306
High resolution separation of explosives and related compounds	



04

Analytical HPLC

www.merckmillipore.com/analytical-hplc

Superspher® Silica carrier for highly efficient separations	page 308
Superspher® For highly efficient HPLC of complex mixtures where high peak capacity is required	page 309
LiChrospher® Silica carrier for constant top-rate results	page 312
LiChrospher® 100 RP-18 and RP-18 endcapped	page 314
LiChrospher® WP 300 RP-18 High-resolution separations of peptides and tRNA molecules	page 320
LiChrospher® PAH Indispensable in PAH trace analysis	page 322
LiChrospher® 100 RP-8 and RP-8 endcapped For reproducible reversed phase separation	page 325
LiChrospher® 60 RP-select B Excellent separations even with basic compounds	page 329
LiChrospher® 100 CN Excellent for complex samples with polar and hydrophobic characteristics	page 334
LiChrospher® 100 NH ₂ A versatile sorbent for both reversed phase and normal phase chromatography	page 336
LiChrospher® 100 DIOL Excellent for complex samples with polar and hydrophobic characteristics and for exclusion chromatography	page 338
LiChrospher® Si 60 and Si 100	page 340
LiChrosorb® Irregular shaped silica sorbent	page 342
LiChrosorb® A successful packing material from the start	page 343
Aluspher® Alkaline stable HPLC separations	page 345
Aluspher® RP-select B A stable reversed phase stationary phase optimized for applications up to pH 12	page 346
SeQuant® HILIC ZIC®-HILIC, ZIC®-cHILIC and ZIC®-pHILIC are the ideal columns for all classes of polar hydrophilic compounds	page 348
SeQuant® ZIC®-HILIC High-performance columns for hydrophilic compounds	page 354
SeQuant® ZIC®-cHILIC Complementary selectivity for polar hydrophilic compounds	page 359
SeQuant® ZIC®-pHILIC Polymeric columns with extended pH stability for demanding separations of hydrophilic compounds	page 362

Chiral stationary phases _____	page 363
Always the proper column for enantiomer analysis	
ChiraDex® _____	page 364
Specially for the separation of enantiomers	
Customized packings _____	page 366
Customized packings _____	page 367
Always the right column	
Accessories _____	page 370
manu-CART® cartridge holder for LiChroCART® cartridges _____	page 370
Accessories for particulate HPLC columns	
LiChroCART® cartridge _____	page 373
Accessories for particulate HPLC columns	
Hibar® column _____	page 375
Accessories for particulate HPLC columns	
LiChroTest® _____	page 378
Standard samples for HPLC system qualification	
Column care and use _____	page 380
Trouble-Shooting _____	page 388

05

Preparative HPLC

400

www.merckmillipore.com/preparative-hplc

Preparative HPLC _____	page 403
Aluminium oxide _____	page 404
For preparative chromatography	
Standardized silica gels _____	page 406
LiChroprep® _____	page 408
PharmPrep® P sorbent _____	page 410
New high-performance spherical silica	
Silanized silica _____	page 414
Micro-crystalline cellulose _____	page 415
Florisil® _____	page 416
Chromolith® Prep _____	page 417
Chromolith® - increase in speed, efficiency and productivity	
Hibar® pre-packed columns _____	page 418
Hibar® customized pre-packed columns _____	page 419
25 and 50 mm internal diameter	
Scaling the separation _____	page 420

06

Ion Chromatography

432

www.merckmillipore.com/ion-chromatography

Ion Chromatography _____	page 434
SeQuant® SAMS Et CARS suppressor system _____	page 435
High sensitivity and low background in anion chromatography	

07

Gas Chromatography

440

www.merckmillipore.com/gas-chromatography

Gas Chromatography	page 443
High purity solvents for gas chromatography	page 444
SupraSolv® Solvents for gas chromatography	page 445
SupraSolv® Solvents for headspace gas chromatography	page 448
UniSolv® Solvents for organic trace analysis	page 452
Sorbents for packed columns	page 456
Derivatization reagents	page 457
Reference substances	page 459

08

Service

462

Subject index	page 465
Index of ordering numbers	page 468
Analytical Application Finder	page 475
Merck Millipore around the world	page 476
Learning Center	page 483



01

Mobile Phases & Reagents



www.merckmillipore.com/mobile-phases-for-chromatography

Meet the mobile phases and reagents that are used in almost every HPLC laboratory in the world. Whether for analyzing foods or pharmaceuticals, the superior raw materials, meticulous purification, and stringent quality controls of Merck Millipore's mobile phases and reagents ensure accurate results time after time.



01

Contents

Mobile Phases & Reagents for HPLC and TLC page 17

LiChrosolv®
Solvents for analytical chromatography page 18

LiChrosolv® hypergrade
A new standard in HPLC solvents page 24

Prepsolv®
Solvents for preparative chromatography page 28

Solvent Management System page 29

Solvents handling in bottles page 30

Options for solvents handling in barrels page 33

Lab Water Purification
Production of ultrapure water suitable for HPLC page 37

Elix® Advantage system
Tap to pure water page 40

Milli-Q® Advantage A10® system
Pure to ultrapure water page 41

Milli-Q® Integral system
Tap to pure & ultrapure water page 42

LiChropur® reagents for analytical HPLC page 43

Mobile Phases & Reagents for HPLC and TLC

Introduction

Analytical HPLC has taken on a position of central importance in research and development, in pharmaceutical quality control and in environmental analysis. The various tasks involved place high requirements on the performance of the solvents used.

High purity, low UV absorbance, low particle count, low acidity and alkalinity combined with low evaporation residue are the basic preconditions for solvents to ensure reproducible and accurate chromatographic results, both in HPLC and TLC. These requirements are ideally fulfilled by **LiChrosolv® solvents**, which are manufactured using specially selected raw materials and purified in a multi-stage process with the highest batch-to batch consistency. **LiChrosolv® HPLC solvents** are manufactured to completely eliminate any trace contamination which may cause inaccurate results when using UV or fluorescence detectors.

The combination of classical Liquid Chromatography (LC) with Mass Spectrometry (MS) is fast becoming the dominant analytical tool for researchers in virtually every field of chemical analysis. LC-MS combines the advantages of a chromatographic separation with mass detection by MS: low detection limits and analysis of molecular structures e.g. identification and characterization of metabolites. **LiChrosolv® hypergrade solvents** are designed with very high UV-transmittance as well as very low metal ion content and very low LC-MS background signal. Application-oriented solvent quality ensures optimum chromatographic results, and avoids costly analysis repetition and loss of valuable samples.

Prepsolv® solvents are tailored to facilitate scale-up from analytical to preparative separations. With their special characteristics, e.g. of low residue on evaporation, this solvent quality ensures optimal product yield and column protection.

Solvent Management System

Merck Millipore's high purity solvents are available in returnable stainless steel barrels, as well as in glass and aluminium bottles. Whatever vessel is used, the Merck Millipore Solvent Management System is designed to ensure safe and contamination-free solvent usage in laboratory applications.

The Solvent Management System includes options for:

- safe carrying of bottles
- safe and contamination-free connection of bottles and barrels to instruments
- contamination-free waste bottle connection
- central storage in safety cabinets / with fume hood supply rooms

Lab Water Purification Systems

The production of "ultrapure water" using a Merck Millipore Lab Water Purification System is a crucial step prior to liquid chromatography to efficiently reduce water contaminants to minimum levels.

LiChrosolv®

Solvents for analytical chromatography

Modern analytical HPLC often uses gradient methods, which require higher solvent quality compared to isocratic methods. For this reason, we provide many LiChrosolv® solvents in both isocratic and gradient quality.

LiChrosolv® high purity solvents are available in an extensive product range: volumes of 1 liter, 2.5 liters and 4 liters are available in glass bottles, 5 liters in aluminium bottles and 10 liters, 30 liters and 185 liters in returnable stainless steel barrels. Higher volume vessels (e.g. 1000 L container) are available on request. Packaging details and safety accessories are described in our new product information catalog "Accuracy – you can count on".

For information on safe and contamination-free solvent withdrawal from bottles and barrels, please refer to the section "Solvent Management System".

Benefits

- **Minimal baseline noise** – accurate results, no risk of misinterpretation
- **Low level of ionic background, reduced metal adduct formation** – high analyte signal intensities
- **Optimized packaging material** – avoidance of interaction between solvent and packaging
- **Special S40 adapters for direct instrument connection available** – contamination free solvents handling and maximum protection of staff and environment



LiChrosolv® Acetonitrile hypergrade for LC-MS suitability in 1 and 2.5 L specially treated amber glass bottles.

► **Superspher®**
Silica carrier for highly efficient separations
page 308

► **LiChrosorb®**
Irregular shaped silica sorbent
page 342

Accessories for particulate HPLC columns:

► **LiChroCART®** cartridge
Different lengths, different internal diameter
page 373

Ordering information – LiChrosolv® A-C

Product	Ordering No.	Content / Packaging	Purity (GC) min. [%]	Evap. residue max. [mg/L]	Water max. [%]	Acidity max. [meq/g]	Alkalinity max. [meq/g]	UV-transm. at [nm]
Acetone	1.00020.1000	1 L GL	99.8	2	0.05	0.0002	0.0002	335 (50 %), 340 (80 %), 350 (98 %)
	1.00020.2500	2.5 L GL						
	1.00020.4000	4 L GL						
	1.00020.5000	5 L AL						
	1.00020.9010	10 L ST						
	1.00020.9030	30 L ST						
Acetonitrile hypergrade, LC-MS suitability ¹⁾	1.00029.1000	1 L GL*	99.9	1	0.01	0.0001	0.0002	191 (25 %), 195 (85 %), 200 (96 %), 215 (98 %), 230 (99 %)
	1.00029.2500	2.5 L GL*						
	1.00029.9010	10 L ST						
	1.00029.9030	30 L ST						
Acetonitrile gradient grade, suitable for UPLC UHPLC, Reag. Ph Eur ²⁾ , ACS ³⁾	1.00030.1000	1 L GL	99.9	2	0.02	0.0002	0.0002	193 (60 %), 195 (80 %), 230 (98 %)
	1.00030.2500	2.5 L GL						
	1.00030.4000	4 L GL						
	1.00030.5000	5 L AL						
	1.00030.9010	10 L ST						
	1.00030.9030	30 L ST						
Acetonitrile isocratic grade	1.14291.1000	1 L GL	99.8	4	0.05	0.0005	0.0002	195 (70 %), 200 (90 %), 240 (98 %)
	1.14291.2500	2.5 L GL						
	1.14291.4000	4 L GL						
	1.14291.5000	5 L AL						
	1.14291.9010	10 L ST						
	1.14291.9030	30 L ST						
1-Butanol	1.01988.1000	1 L GL	99.8	2	0.05	0.0002	0.0002	230 (75 %), 240 (85 %), 310 (99 %)
	1.01988.2500	2.5 L GL						
tert-Butyl methyl ether	1.01845.1000	1 L GL	99.8	2	0.02	0.0002	0.0002	240 (60 %), 255 (85 %), 280 (98 %)
	1.01845.2500	2.5 L GL						
	1.01845.9010	10 L ST						
	1.01845.9030	30 L ST						
	1.01845.9185	185 L ST						
1-Chlorobutane	1.01692.1000	1 L GL	99.8	2	0.01	0.0002	0.0002	227 (60 %), 232 (80 %), 250 (98 %)
Chloroform stabilized with 2-methyl-2-butene and methanol	1.02444.1000	1 L GL	99.8	5	0.01	0.0002	0.0002	255 (70 %), 260 (85 %), 300 (98 %)
	1.02444.2500	2.5 L GL						
	1.02444.4000	4 L GL						
	1.02444.9010	10 L ST						

All solvents are filtered through 0.2 µm. | GL = glass bottle | AL = aluminium bottle | ST = stainless steel returnable barrel | * specially treated amber glass |

1) New extended specification | 2) Conforms to Acetonitrile for chromatography and Acetonitrile R1 acc. to Reag. Ph Eur | 3) Conforms to the requirements of ACS liquid chromatography suitability

Ordering information – LiChrosolv® C-L

Product	Ordering No.	Content / Packaging	Purity (GC) min. [%]	Evap. residue max. [mg/L]	Water max. [%]	Acidity max. [meq/g]	Alkalinity max. [meq/g]	UV-transm. at [nm]
Cyclohexane	1.02827.1000	1 L GL	99.9	2	0.01	0.0002	0.0002	230 (75 %), 240 (90 %), 260 (99 %)
	1.02827.2500	2.5 L GL						
1,2-Dichloroethane	1.13713.1000	1 L GL	99.8	2	0.02	0.0002	0.0002	240 (85 %), 245 (90 %), 270 (99 %)
Dichloromethane stabilized	1.06044.1000	1 L GL	99.9	5	0.01	0.0002	0.0002	240 (70 %), 245 (90 %), 260 (99 %)
	1.06044.2500	2.5 L GL						
	1.06044.4000	4 L GL						
	1.06044.9010	10 L ST						
	1.06044.9030	30 L ST						
1,4-Dioxane	1.03132.1000	1 L GL	99.8	2	0.02	0.0002	0.0002	245 (50 %), 270 (80 %), 300 (98 %)
	1.03132.2500	2.5 L GL						
Ethanol gradient grade, suitable for UPLC UHPLC	1.11727.1000	1 L GL	99.9	2	0.1	0.0002	0.0002	225 (60 %), 240 (85 %), 260 (98 %)
	1.11727.2500	2.5 L GL						
	1.11727.4000	4 L GL						
	1.11727.9030	10 L ST						
Ethyl acetate	1.11727.9185	185 L ST						
	1.00868.1000	1 L GL	99.8	2	0.05	0.0002	0.0002	260 (50 %), 265 (80 %), 270 (98 %)
	1.00868.2500	2.5 L GL						
	1.00868.4000	4 L GL						
1.00868.9010	10 L ST							
n-Heptane	1.04390.1000	1 L GL	99.3	2	0.005	0.0002	0.0002	210 (50 %), 220 (80 %), 245 (98 %)
	1.04390.2500	2.5 L GL						
	1.04390.9010	10 L ST						
	1.04390.9030	30 L ST						
	1.04390.9185	185 L ST						
n-Hexane	1.04391.1000	1 L GL	98.0	1	0.01	0.0002	0.0002	210 (50 %), 220 (85 %), 245 (98 %)
	1.04391.2500	2.5 L GL						
	1.04391.4000	4 L GL						
	1.04391.5000	5 L AL						
	1.04391.9010	10 L ST						
	1.04391.9030	30 L ST						
	1.04391.9185	185 L ST						
Isohexane (C ₆ H ₁₄ Isomere)	1.04335.2500	2.5 L GL	99.0	2	0.005	0.0002	0.0002	210 (60 %), 220 (80 %), 245 (98 %)
Isooctane	1.04717.1000	1 L GL	99.0	2	0.01	0.0005	0.0002	210 (50 %), 220 (80 %), 245 (98 %)
	1.04717.2500	2.5 L GL						

All solvents are filtered through 0.2 µm. | GL = glass bottle | AL = aluminium bottle | ST = stainless steel returnable barrel

Ordering information – LiChrosolv® M-Z

Product	Ordering No.	Content / Packaging	Purity (GC) min. [%]	Evap. residue max. [mg/L]	Water max. [%]	Acidity max. [meq/g]	Alkalinity max. [meq/g]	UV-transm. at [nm]
NEW Methanol hypergrade, suitable for LC-MS ¹⁾	1.06035.1000	1 L GL*	99.9	1	0.01	0.0002	0.0002	210 (35 %), 220 (60 %), 230 (75 %), 260 (98 %)
	1.06035.2500*	2.5 L GL*						
Methanol gradient grade, suitable for UPLC UHPLC, Reag. Ph Eur ²⁾ , ACS ³⁾	1.06007.1000	1 L GL	99.9	2	0.02	0.0005	0.0002	210 (20 %), 220 (60 %), 230 (75 %), 235 (83 %), 250 (95 %), 260 (98 %)
	1.06007.2500	2.5 L GL						
	1.06007.4000	4 L GL						
	1.06007.5000	5 L AL						
	1.06007.9010	10 L ST						
	1.06007.9030	30 L ST						
Methanol isocratic grade	1.06018.1000	1 L GL	99.8	3	0.03	0.0005	0.0002	225 (50 %), 240 (80 %), 265 (98 %)
	1.06018.2500	2.5 L GL						
	1.06018.4000	4 L GL						
	1.06018.5000	5 L AL						
	1.06018.9010	10 L ST						
	1.06018.9030	30 L ST						
1-Propanol	1.01024.1000	1 L GL	99.8	2	0.02	0.0005	0.0002	230 (70 %), 240 (80 %), 270 (98 %)
	1.01024.2500	2.5 L GL						
	1.01024.4000	4 L GL						
2-Propanol gradient grade, suitable for UPLC UHPLC	1.01040.1000	1 L GL	99.9	2	0.05	0.0005	0.0002	220 (80 %), 230 (90 %), 250 (98 %)
	1.01040.2500	2.5 L GL						
	1.01040.4000	4 L GL						
	1.01040.5000	5 L AL						
	1.01040.9010	10 L ST						
	1.01040.9030	30 L ST						
Tetrahydrofuran not stabilized	1.08101.1000	1 L GL	99.9	1	0.02	0.0005	0.0002	218 (30 %), 230 (35 %), 250 (65 %), 280 (95 %)
	1.08101.2500	2.5 L GL						
	1.08101.4000	4 L GL						
	1.08101.9010	10 L ST						
	1.08101.9030	30 L ST						
Toluene	1.08327.1000	1 L GL	99.9	2	0.05	0.0005	0.0002	300 (70 %), 310 (80 %), 350 (98 %)
	1.08327.2500	2.5 L GL						
	1.08327.4000	4 L GL						
NEW Water gradient grade, suitable for LC-MS and UPLC UHPLC ¹⁾	1.15333.1000	1 L GL	-	5	-	-	-	-
	1.15333.2500	2.5 L GL						
	1.15333.4000	4 L GL						
	1.15333.9010	10 L ST						
	1.15333.9030	30 L ST						

All solvents are filtered through 0.2 µm. | GL = glass bottle | AL = aluminium bottle | ST = stainless steel returnable barrel | * specially treated amber glass |

1) New extended specification | 2) Conforms to Methanol R1 and R2 acc. to Reag. Ph Eur | 3) Conforms to the requirements of ACS liquid chromatography suitability

Specifications of LiChrosolv® gradient grade products for UPLC and UHPLC

Product	Cat. No.	Evaporation residue [max. mg/L]	Gradient at nm [max. mAU]			Fluorescence ¹ at nm [max. ppb]	
			210	235	254	254	365
Acetonitrile	100030	2	1.0	–	0.5	1.0	0.5
Ethanol	111727	2	–	5.0	2.0	–	–
Methanol	106007	2	–	2.0	1.0	1.0	0.5
2-Propanol	101040	2	–	1.0	1.0	–	–
Water	115333	5	5.0	–	0.5	1.0	0.5

¹ = calculated as Quinine in 0.05 mol/l H₂SO₄

Batch chromatogram (gradient profile) of LiChrosolv® Acetonitrile gradient grade [100030]

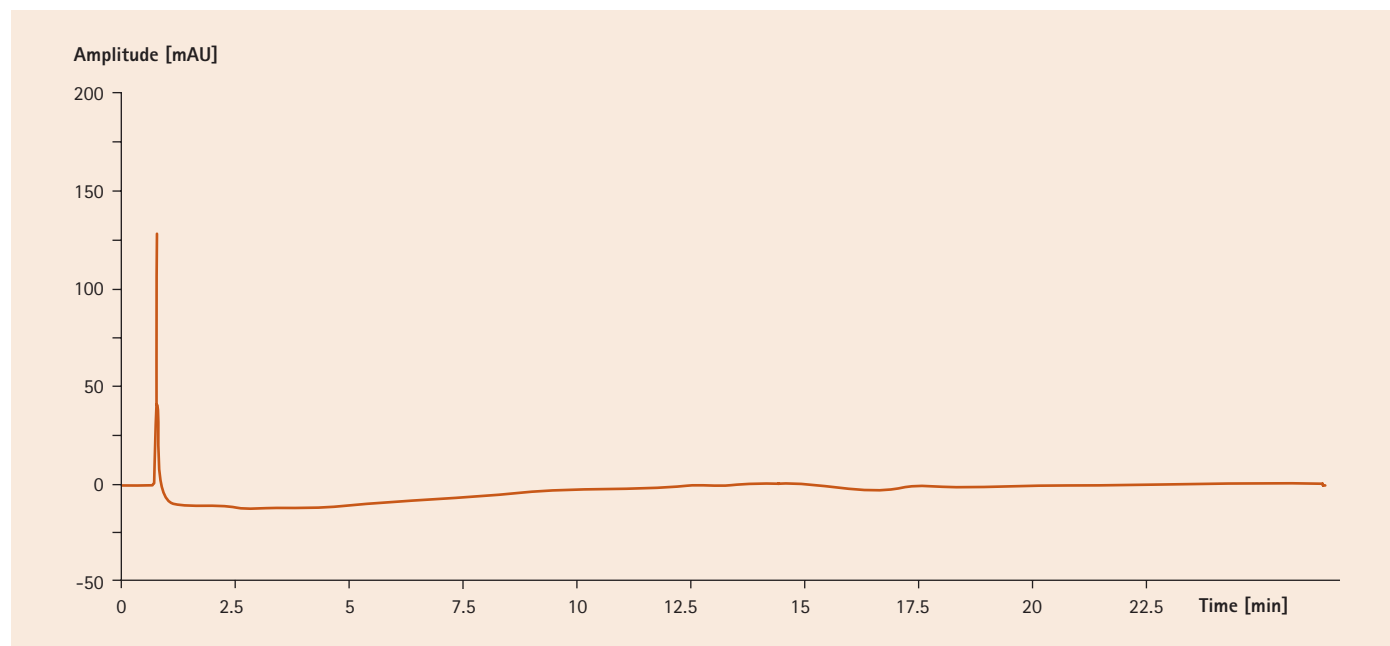

Mobile phase quality and contamination

The figures display the influence of LiChrosolv® acetonitrile quality on the background noise intensity in mass spectra. Merck Millipore solvents labelled "hypergrade for LC-MS LiChrosolv®" are dedicated to the use with MS systems and deliver minimized contaminant peaks, ion suppression, adduct formation and background noise and therefore maximize sensitivity. Gradient grade solvent quality labelled "gradient grade for liquid chromatography LiChrosolv®" is suitable for LC-UV gradient runs, while isocratic grade solvents are optimized for isocratic separations.

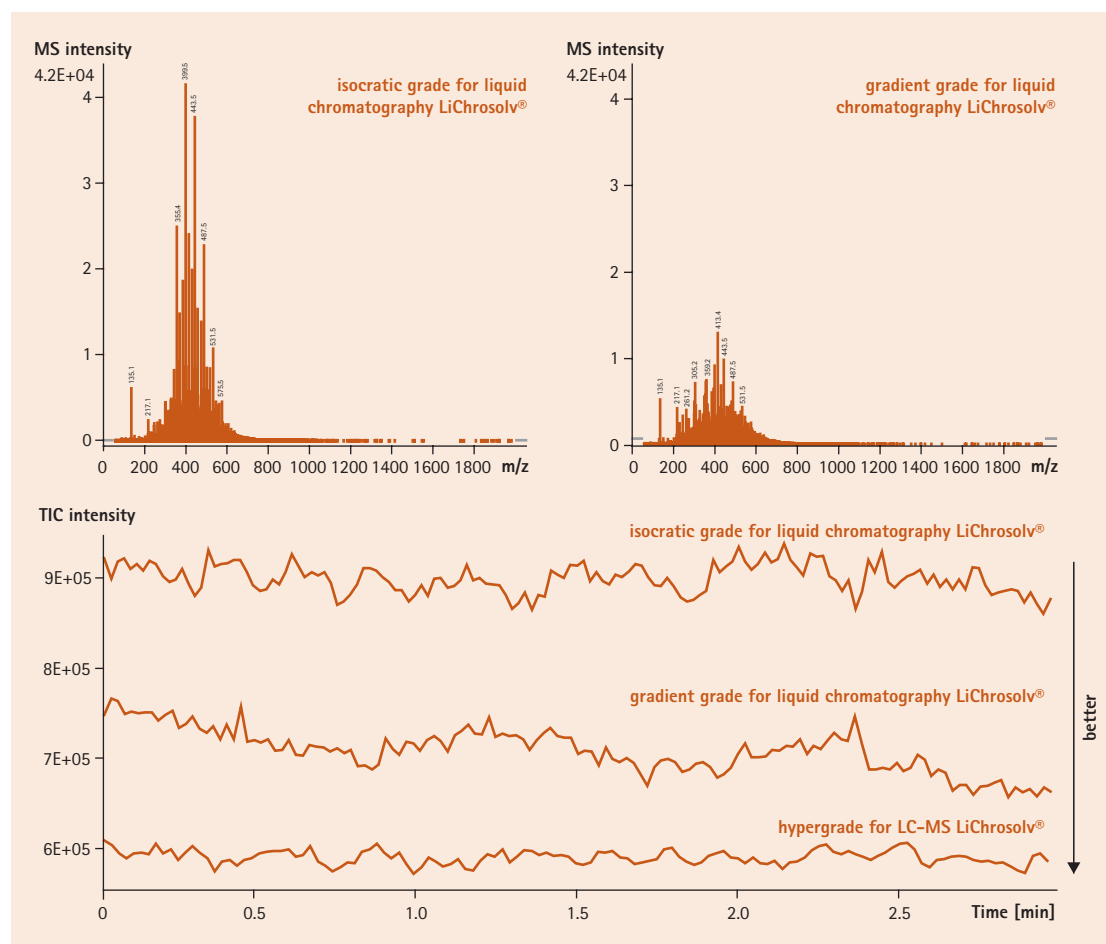

MS spectra of the analysis of two different ACN qualities (top) and combined TICs of the analysis of three different acetonitrile qualities (bottom). All solvents were directly injected into the MS source via a syringe pump during three minutes.

LiChrosolv® hypergrade

A new standard in HPLC solvents

Solvents for LC-MS and trace analysis with UV and fluorescence detection; 0.2 µm stainless steel filtered – perfect for use in UPLC® and UHPLC

The determination of polycyclic aromatic hydrocarbons (PAHs) in environmental samples is one of the more complex problems to be solved by HPLC. LiChrosolv® hypergrade solvents enable analysis in the low ppb trace range and can be used for both the isocratic separation of 6 PAHs according to the German DIN method and the gradient separation of 16 PAHs according to the methods EPA 610 (analysis of drinking water) and EPA 550 + benzo(e) pyrene + perylene (analysis of waste water). Particularly when using wavelength switching with fluorescence detection, reliable results are highly dependent on the degree of purity of the solvents used. The LiChrosolv® hypergrade grade provides the highest degree of application reliability in HPLC gradient methods with subsequent UV or fluorescence detection.

Acetonitrile LiChrosolv® hypergrade is manufactured using particularly precise performance processes and is tested using highly sensitive analytical methods. By using the method of total fluorimetry in quality assurance, we are able to specify emission intensities in the range from 250 to 700 nm at excitation wavelength between 240 and 600 nm to be smaller than those produced by the following standard test solutions: a) quinine (1 ng/mL in 0.05 mol/L H₂SO₄) and b) PAH (1:100000 in acetonitrile; NIST SRM 1647b). The optimized validation of the UV-VIS measuring technique enables us to describe practically ideal transmittance values. LC-MS is another analytical technique placing strong demands on solvent quality. LC-MS combines the advantages of a chromatographic separation with mass detection: low detection limits and analysis of molecular structures e.g. characterization of metabolites. LiChrosolv® hypergrade solvents ensure very high UV-transmittance, excellent baseline stability in gradient elution and also very low total ionic current (TIC) in LC-MS. Thanks to low level of ionic background and ion suppression, this quality ensures high ionization efficiency in all ionization methods (ESI/APCI positive and negative mode). A new standard for HPLC solvent quality has been set. LiChrosolv® hypergrade solvents are the best choice for LC-MS applications.

Specifications of LiChrosolv® hypergrade solvents

Product	Purity [%]	Evap. residue max. [mg/L]	Water max. [%]	Gradient at nm [max. mAU]				UV-transmission at nm
				210	220	235	254	
Acetonitrile	99.9	1	0.01	1.0	–	–	0.5	191 nm (25 %) 195 nm (85 %) 200 nm (96 %) 215 nm (98 %) 230 nm (99 %)
Methanol	99.9	1	0.01		2.0 ¹⁾	1.0 ¹⁾		210 nm (35 %) 220 nm (60 %) 230 nm (75 %) 260 nm (98 %)
Suitability for LC-MS (detected by ion trap-MS)				Mode: ESI 200 µl pos/APCI 200 µl pos				≤2 ppb
Intensity of single mass peak based on reserpine standard				Mode: ESI 200 µl neg/APCI 200 µl neg				≤20 ppb
				Al (Aluminium) ¹⁾				≤10 ppb
				Ca (Calcium) ¹⁾				≤10 ppb
				Fe (Iron) ¹⁾				≤10 ppb
				Mg (Magnesium) ¹⁾				≤10 ppb
				Na (Sodium)		for Acetonitrile		≤50 ppb
						for Methanol		≤100 ppb
				K (Potassium) ¹⁾				≤5 ppb
				Every other signal metal (ICP-MS) ¹⁾				≤5 ppb

1) New extended specification

► Customized packings
Always the right column
page 366

Accessories for particulate
HPLC columns:

► LiChroCART® cartridge
Different lengths, different
internal diameter
page 373

Specifications of LiChrosolv® water for chromatography (LC-MS)

Colony count		≤25 CFU/g
Spec. conductance at 25°C [at time of manufacturing]		≤1 µS/cm
TOC (at time of manufacturing) ¹⁾		≤30 ppb
Evaporation residue max.		5 mg/L
Suitability for LC-MS (detected by ion trap-MS) Intensity of single mass peak based on reserpine standard	Mode: ESI 200 µl pos/APCI 200 µl pos	≤1 ppb
	Mode: ESI 200 µl neg/APCI 200 µl neg	≤20 ppb
	Al (Aluminium) ¹⁾	≤10 ppb
	Ca (Calcium) ¹⁾	≤100 ppb
	Fe (Iron) ¹⁾	≤5 ppb
	Mg (Magnesium) ¹⁾	≤20 ppb
	Na (Sodium) ¹⁾	≤200 ppb
	K (Potassium) ¹⁾	≤10 ppb
	Every other signal metal (ICP-MS) ¹⁾	≤5 ppb
Anions (Ion chromatography)	Chloride ¹⁾	≤10 ppb
	Sulfate ¹⁾	≤10 ppb
	Nitrate ¹⁾	≤10 ppb
	Phosphate ¹⁾	≤10 ppb

1) New extended specification

Ordering information – LiChrosolv® hypergrade

Product	Ordering No.	Content / Packaging
Acetonitrile	1.00029.1000	1 L GL*
	1.00029.2500	2.5 L GL*
	1.00029.9010	10 L ST
	1.00029.9030	30 L ST
Methanol	1.06035.1000	1 L GL*
	1.06035.2500	2.5 L GL*

GL = glass bottle | ST = stainless steel returnable barrel | * specially treated amber glass

Ordering information – LiChrosolv® water for chromatography (LC-MS)

Product	Ordering No.	Content / Packaging
Water	1.15333.1000	1 L GL*
	1.15333.2500	2.5 L GL*
	1.15333.4000	4 L GL*
	1.15333.9010	10 L ST
	1.15333.9030	30 L ST

GL = glass bottle | ST = stainless steel returnable barrel | * specially treated amber glass

Ordering information – LiChrosolv® ready-to-use blends

Product	Ordering No.	Content / Packaging	Assay TFA [%]	ACN [%]	H ₂ O [%]
NEW Acetonitrile + 0.05 % Acetic acid (v/v) hypergrade, LC-MS suitability	1.59006.2500	2.5 L GL			
	1.59006.4000	4 L GL			
NEW Acetonitrile + 0.05 % Formic acid (v/v) hypergrade, LC-MS suitability	1.59003.2500	2.5 L GL			
	1.59003.4000	4 L GL			
Acetonitrile + 0.05 % TFA (v/v) hypergrade, LC-MS suitability	4.80672.2500	2.5 L GL	0.045 – 0.055		
NEW Acetonitrile + 0.1 % Acetic acid (v/v) hypergrade, LC-MS suitability	1.59004.2500	2.5 L GL			
	1.59004.4000	4 L GL			
NEW Acetonitrile + 0.1 % Formic acid (v/v) hypergrade, LC-MS suitability	1.59002.1000	1 L GL			
	1.59002.2500	2.5 L GL			
	1.59002.4000	4 L GL			
Acetonitrile + 0.1 % TFA (v/v) hypergrade, LC-MS suitability	4.80448.2500	2.5 L GL	0.095 – 0.105		
	4.80448.4000	4 L GL			
	4.80448.9030	30 L ST			
Acetonitrile + Water 60:40 (v/v)	4.80853.4000	4 L GL		59.0 – 61.0	39.0 – 41.0
Acetonitrile + Water 80:20 (v/v)	4.80159.2500	2.5 L GL			
Methanol + Water 30:70 (v/v)	4.80508.9030	30 L ST			
NEW Water + 0.05 % Acetic acid (v/v) hypergrade, LC-MS suitability	1.59008.2500	2.5 L GL			
	1.59008.4000	4 L GL			
Water + 0.05 % TFA (v/v) hypergrade, LC-MS suitability	4.80170.2500	2.5 L GL	0.045 – 0.055		
	4.80170.4000	4 L GL			
NEW Water + 0.1 % Acetic acid (v/v) hypergrade, LC-MS suitability	1.59007.2500	2.5 L GL			
	1.59007.4000	4 L GL			
NEW Water + 0.1 % Formic acid (v/v) hypergrade, LC-MS suitability	1.59013.4000	4 L GL			
	4.80112.2500	2.5 L GL	0.095 – 0.105		
	4.80112.4000	4 L GL			
Water + 0.1 % TFA (v/v) hypergrade, LC-MS suitability	4.80112.9030	30 L ST			

GL = glass bottle | ST = stainless steel returnable barrel | TFA = Trifluoroacetic acid

Separation examples with LiChrosolv® hypergrade

16 PAH acc. to EPA 610/550 + benzo(e)pyrene + perylene by fluorescence detection

Column	LiChroCART® 250-4 LiChrospher® PAH, 5 µm		
Mobile phase	A: Acetonitrile hypergrade LiChrosolv® B: Water LiChrosolv®		
Gradient	0-3 min 60 % A 3-15 min 60 % A – 100 % A 15-50 min 100 % A		
Flow rate	1.0 mL/min		
Detection	Programmed fluorescence detection		
	Peak No.	Ex nm	Em nm
	1, 3, 4	280	330
	5	246	370
	6	250	486
	7	280	450
	8	270	390
	9, 10	265	380
	11 – 15	290	430
	16, 17	290	410
	18	300	500
Temperature	20°C		

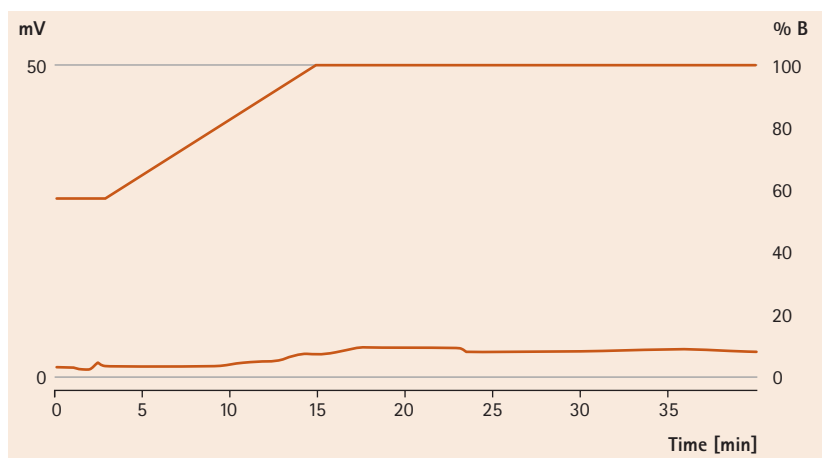

Blank value of Acetonitrile LiChrosolv® hypergrade in PAH determination according to EPA 610

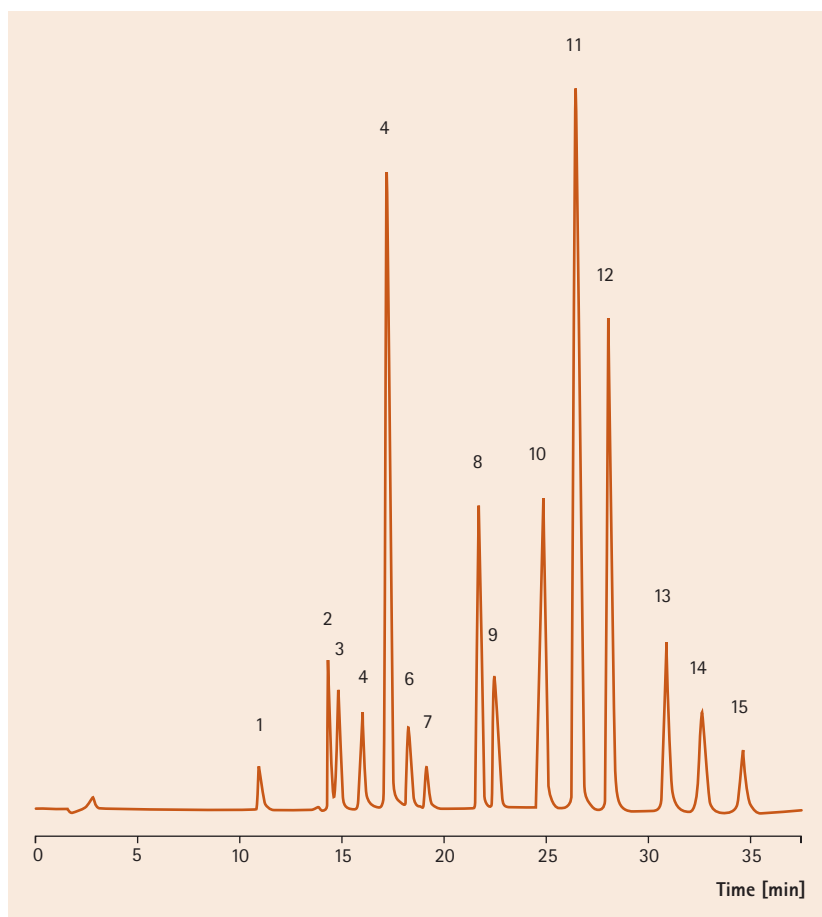

Application: Determination of 16 PAH acc. to EPA 610/550 with programmed fluorescence detection

In order to facilitate scale-up from analytical to preparative scale, Prepsolv® HPLC solvents are manufactured for the special requirements of preparative chromatography. These are characterized by an extremely low evaporation residue (<1 mg/L) and a low water content. Preparative chromatography installations using significant quantities of high quality solvents have to ensure that the solvents are delivered and used in the right way to ensure optimum results.

Prepsolv® solvents for large-scale application are supplied in returnable stainless steel barrels, which are inert to the chemical contents, strong for repeated transport and are provided complete with two types of opening for versatility of connection. The extensive range of withdrawal systems ensure that the solvents can always be safely and easily used without any risk of contamination. Standard sizes are 30 liters, 185 liters and 1000 liters. If desired Merck Millipore will supply tailor-made volumes to fit the need of the individual customer.

Specifications of Prepsolv® solvents

Product	Purity (GC) min. [%]	Evap. residue max. [mg/L]	Water max. [%]	Acidity max. [meq/g]	Alkalinity max. [meq/g]	UV-transmission at nm	
						50 %	98 %
Acetonitrile	99.8	1	0.05	0.0005	0.0002	220	240
Methanol	99.8	1	0.05	0.0002	0.0002	225	265
2-Propanol	99.8	1	0.05	0.0002	0.0002	220	260
Ethyl acetate	99.8	1	0.05	0.0002	0.0002	270	300
n-Hexane	95.0	1	0.01	0.0002	0.0002	220	250

Ordering information of Prepsolv®

Product	Ordering No.	Contents	Packaging
Acetonitrile	1.13358.2500	2.5 L	glass bottle
	1.13358.9030	30 L	stainless steel returnable barrel
	1.13358.9185	185 L	stainless steel returnable barrel
	1.13358.9910*	1000 L	stainless steel 1000 L container
Ethyl acetate	1.13353.9030	30 L	stainless steel returnable barrel
n-Hexane	1.04394.9030	30 L	stainless steel returnable barrel
Methanol	1.13351.2500	2.5 L	glass bottle
	1.13351.9030	30 L	stainless steel returnable barrel
	1.13351.9185	185 L	stainless steel returnable barrel
	1.13351.9910*	1000 L	stainless steel 1000 L container
2-Propanol	1.13350.2500	2.5 L	glass bottle
	1.13350.9910*	1000 L	stainless steel 1000 L container

* customized

Solvent Management System

Options for safe solvent handling

Merck Millipore invests heavily in innovative solvent handling technology and product development, focussing on customer requirements and offering a wide range of products and accessories. Our primary goal is to help ensure user safety and the reliability of chromatographic results in the laboratory.

For many years, Merck Millipore has worked closely with customers to develop solvent withdrawal systems that are tailor-made according to packaging types.

Today, our broad range of withdrawal systems and containers is unrivalled in the industry. As a result, customers are assured that whatever the application, Merck Millipore can supply an integrated solution with the right container and the right withdrawal system with matched components for optimal results.

Benefits

- Safe and contamination-free solvent handling, minimizing health and environmental risks
- Easy handling due to ergonomic design
- Optimization of chromatographic reproducibility and accuracy of results
- Direct connections to instruments, central storage and supply
- Customized solvent supply solutions are available
- Cost saving by reducing waste and time efforts



Carry solvent bottles safely

A primary aim of Merck Millipore is to focus on customer's safety. Based on this, Merck Millipore has developed a broad range of safety accessories according to official laboratory regulations, including "Working Safely in Laboratories – Basic Principles and Guidelines" (BGI 850-0e / GUV-I 850-0e).

Handling of solvents in breakable glass bottles has to be treated with particular caution. Merck Millipore provides a special safety carrier for glass bottles with the following properties:

- If the carrier is dropped, the glass bottle is specially protected against breakage, thanks to the high compression strength inlay
- The user is protected against contact with harmful glass splinters and solvents vapors by the leak-proof cover (special feature compared to the bottle baskets or open carriers from other suppliers)
- Even heavy bottles can be easily carried, thanks to the broad carrier handle
- Only special solvent-compatible materials are used in manufacture
- The inlay is specially shaped for the Merck Millipore 2.5 or 4 liter bottles and is also suitable for 1 liter glass bottles

Ordering information – Safety carrier

Product	Ordering No.
Safety carrier for (up to 2.5 L) Merck Millipore glass bottles	9.20078.0001
Safety carrier for (up to 4 L) Merck Millipore glass bottles	1.40140.0001



Benefits

Maximum safety in case of accident:

- no risk of cuts due to glass splinters
- no spillage of hazardous chemicals
- no health risk – no contact with solvents and vapors

High convenience due to broad carrier handle.

Direct connection of solvent-bottles to instruments

Direct connection of solvent bottles to instruments prevents both solvent vapor contaminating the laboratory and solvents themselves being contaminated from the environment.

The Merck Millipore HPLC adapter is specially designed to connect Merck Millipore HPLC solvents in bottles with S40 thread. It is made completely from high quality solvent-resistant PTFE and PE. The adapter ensures that the bottle is completely sealed and the solvents protected against contamination e.g. by dust. The filter technology prevents harmful emissions.

Benefits

- **Maximum protection of users and environment from harmful emissions, thanks to integrated air vent and air filter**
- **Reliable analytical results and cost efficiency, thanks to contamination-free solvent handling in a "closed system"**
- **Minimum downtime, thanks to fixed capillaries, thus also avoiding air absorption by the solvent**
- **Easy exchange of bottles due to free rotation (360°) of the HPLC adapter inlay**



HPLC adapter for solvent supply

The HPLC adapter for solvent supply [Ord. No. 1.03830.0001] is equipped with an air valve that opens when the HPLC pump is working and allows filtered air to flow into the bottle. As soon as the pump stops, the membrane closes immediately, so that no harmful solvent vapor can exhaust. We recommend replacing the filter every 6 months [Ord. No. 1.03832.0001].



HPLC adapter for waste solvent

The HPLC adapter for waste solvents [Ord. No. 1.03831.0001] also keeps the system completely sealed. The overpressure, due to solvent entering the bottle, is released through an exhaust air filter. This filter contains special activated charcoal granules that prevent any harmful evaporation entering the lab. The exhaust air filter should also be exchanged regularly, depending on the application but not later than every 3 months [Ord. No. 1.03833.0001].

Ordering information – Direct connection of solvent-bottles to instruments

Product	Ordering No.
HPLC bottle adapter with 3 tube connections 3.2 mm i.d., solvents supply by Merck Millipore-bottles	1.03830.0001
HPLC bottle adapter S40 with 3 tube connections and 1 connection for exhaust air filter, solvents disposal	1.03831.0001
Air valve for HPLC bottle adapter S40	1.03832.0001
Exhaust air filter for HPLC bottle adapter S40, disposal	1.03833.0001
Fittings for capillaries with 3.2 mm o.d., for HPLC bottle adapter S40 (pack of 10)	1.03834.0001
PTFE-ferrule for capillaries with 3.2 mm o.d., for HPLC bottle adapter S40 (pack of 10)	1.03835.0001
Blanking plug for capillary connections with 3.2 mm i.d., for HPLC bottle adapter S40 (pack of 10)	1.03836.0001

Process automation by level sensor technology

Level sensors for bottles

Alarm display
[Ord. No. 9.67100.2004]

HPLC-instrument

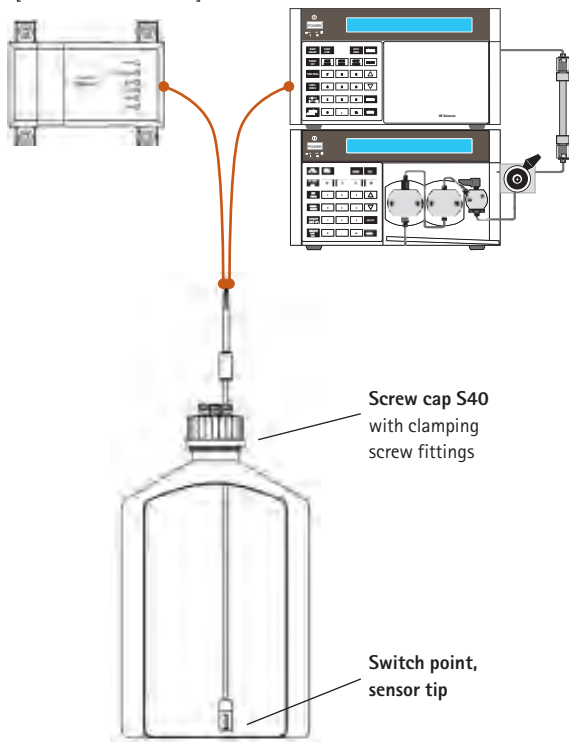

Bottle level sensor for solvent supply
[Ord. No. 9.67100.2001]

Alarm display
[Ord. No. 9.67100.2004]

HPLC-instrument

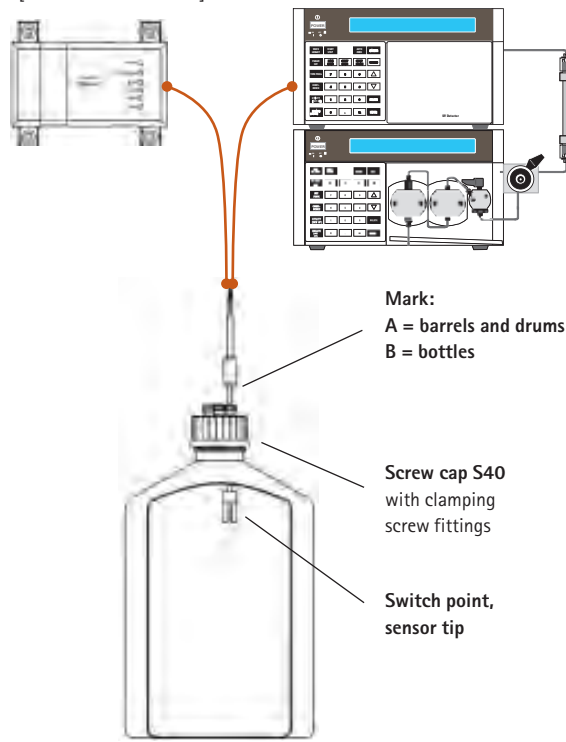

Bottle level sensor for solvent disposal
[Ord. No. 9.67100.2002]

As the pioneer in lab scale level sensing Merck Millipore provides now a safe and convenient solution for process automation in laboratories. Primary for aluminium bottles but also for all other Merck Millipore solvent bottles with S40 thread the sensor is pre-assembled in a screw cap with 3 connection positions to connect e.g. HPLC tubes of 3 mm directly to the bottle. The S40-screw cap is screwed onto the top of the bottle. With a clamping screw the sensor can be adjusted to several bottle sizes or also to the desired level.

- Connecting the sensor to an alarm display for optical and acoustic signalling purposes at the workplace with a built-in acknowledgement function.
- Connecting the bottle sensor signal directly to an HPLC-instrument it stops the HPLC-run automatically to ensure a consistent supply of mobile phase and thus avoiding any reconditioning of the column. For disposal side the sensor prevents from overfilling and from the occurrence of harmful situations.



Direct withdrawal

Using specially developed withdrawal systems and safety accessories, HPLC solvents can be safely and easily withdrawn from stainless steel barrels without risk of contamination.



Withdrawal system with manual pressurization

- Suitable for 10 liter and 30 liter returnable stainless steel barrels
- Safe manual pressurization
- Includes 2 exchangeable dip-tubes, clamp for outlet tube, ball valve, pump ball with rapid action connector and 3-way stopcock

Ordering information –

Withdrawal system for manual pressure build-up in barrels

Product	Ordering No.
Withdrawal system for solvents with manual pressure build-up for 10 L and 30 L stainless steel barrels with 2" opening	1.01123.0001
Antistatic device for earthing metal containers	1.07070.0001
Opening key	1.08803.0001

Withdrawal system with inert gas pressurization

- Suitable for all returnable stainless steel barrels
- Safe pressurization with inert gas (max. pressure 0.2 bar)
- Includes threaded adapter, spiral gas-feed tube, stainless steel coated PTFE-tube and self-closing filling nozzle
- Dip tube must be selected and ordered additionally according to the barrel size



Ordering information –

Withdrawal system for inert gas pressurizing in barrels

Product	Ordering No.
Withdrawal system for stainless steel barrels and drums with threaded adapter, gas feeding tube and filling nozzle with flexible line (necessary in addition: dip tube suit the particular type of container)	1.06710.0001
Dip tube for 10 L stainless steel barrel for withdrawal systems with 2" threaded adapter	9.67100.1040
Dip tube for 30 L stainless steel barrel for withdrawal systems with 2" threaded adapter	9.67100.1041
Dip tube for 185 L stainless steel barrel for withdrawal systems with 2" threaded adapter	9.67100.1185
Antistatic device for earthing metal containers	1.07070.0001
Opening key	1.08803.0001
Pressure reducer with integrated overpressure relief	9.67100.9100

Safety cabinet storage

Using special installations our customers reach maximum safety standards in solvents handling. One important option is to store solvents barrels inside a safety cabinet.

A customized installation with stainless steel tubing directly from the safety cabinet to the fume hood avoids having any open solvent barrel in the laboratory during solvent withdrawal. One flexible filling nozzle placed inside the fume hood can be safely operated, while the solvent barrel itself is stored inside the safety cabinet. No hazardous solvent vapours enter the laboratory, thus ensuring maximum safety for users and environment! Please ask us for your individual installation!



Direct connection to instruments

Another option is to connect solvent barrels directly from the safety cabinet to the HPLC instrument, thereby offering maximum user safety and environment protection. Inert gas back-pressure can be applied to the barrel. Further process security can be provided by using the solvent level sensor technology. These customized installations are available on request – please contact your Merck Millipore supplier to discuss your individual requirements.

HPLC adaptor for direct instrument connection



Merck Millipore has developed a special "S40-to-G2" adaptor 1.01111.0001 to connect solvents in barrels (10 or 30 liters) directly to HPLC instruments with the HPLC bottle connector 1.03830.0001 or 1.03831.0001 (see page 31).

Central storage

Customized central storage installations are always an option to meet the individual needs of our solvents customers. One option is the central storage of solvent barrels inside a safety room from which solvents are supplied to various laboratories.

Please talk to your Merck Millipore contact to find out your individual installation for your maximum safety.

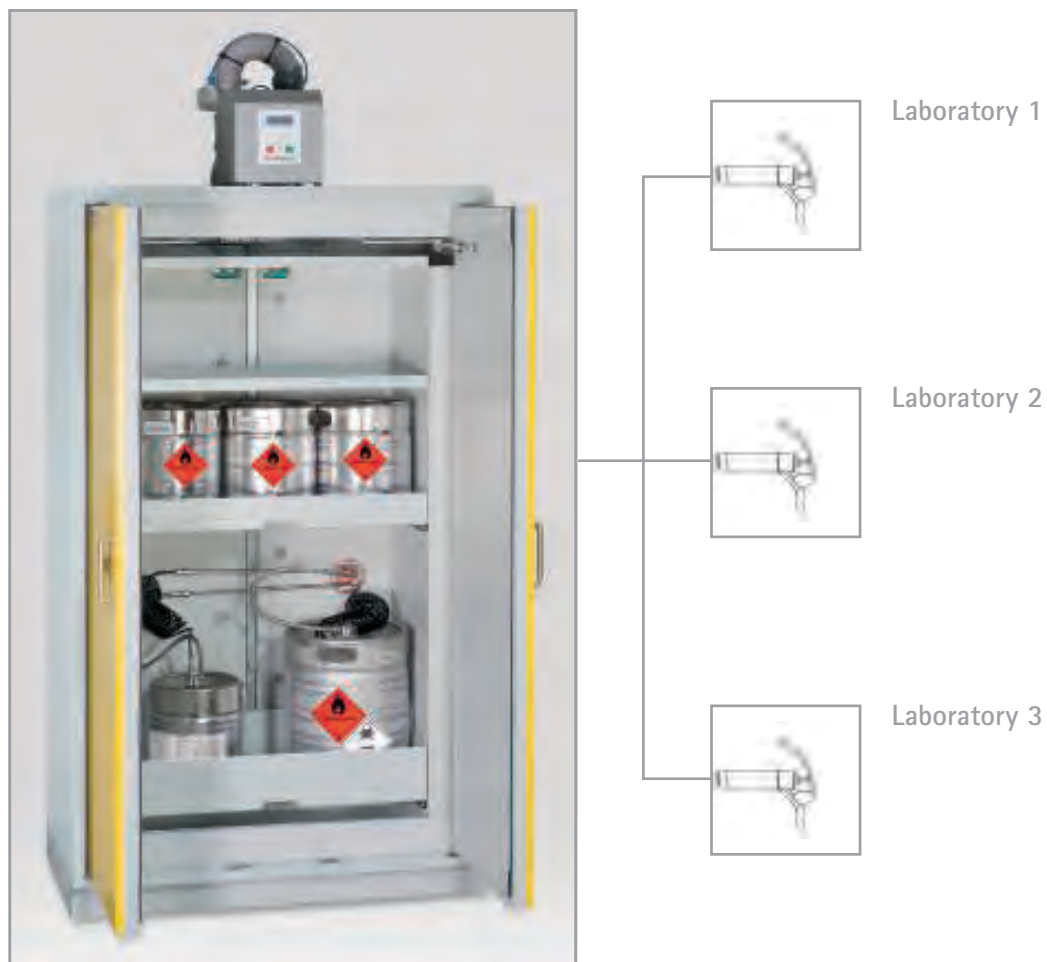

Central supply from one safety cabinet to several laboratories / fume hoods.

Process automation by level sensor technology

Level sensors for barrels and drums

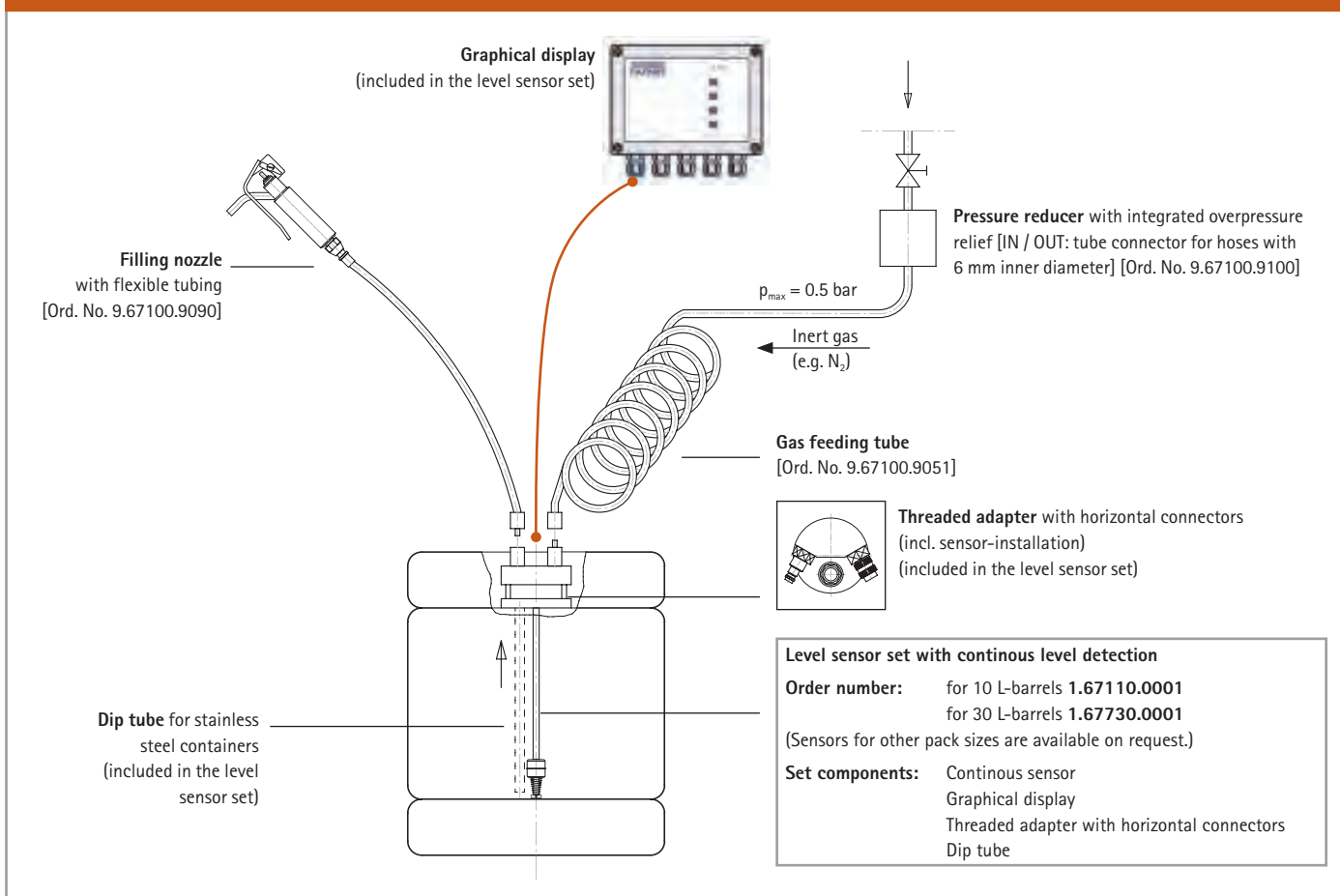

Maximum safety and reliability for your daily work

Continuous level sensor technology with ATEX approval provides maximum safety and reliability for your daily work. The graphical display shows always the exact solvent level inside the container. With adjustable alarm points an individual management, measurement and control of solvents supply and disposal is now available and automatized, e.g. visible control alarms or automatically control of e.g. HPLC-instruments.

The new Merck Millipore sensor set adds the easy aspect to this complex functionality: Pre-assembled for each pack size and convenient to install. By using the filling nozzle and the gas feeding tube the direct withdrawal can immediately start. For customized installations please contact your local supplier to get direct and individual support.



Lab Water Purification

Production of ultrapure water suitable for HPLC

The production of ultrapure water from potable tap involves a combination of different purification technologies to efficiently reduce contaminants to minimum levels. Water purification can be divided in two major steps: a pretreatment step, during which 95 to 99 % of the contaminants originally present in water are removed, and a so-called polishing step, where the remaining contaminants are removed from the water to deliver ultrapure water.

Schematic of water purification chain that delivers ultrapure water suitable for HPLC use

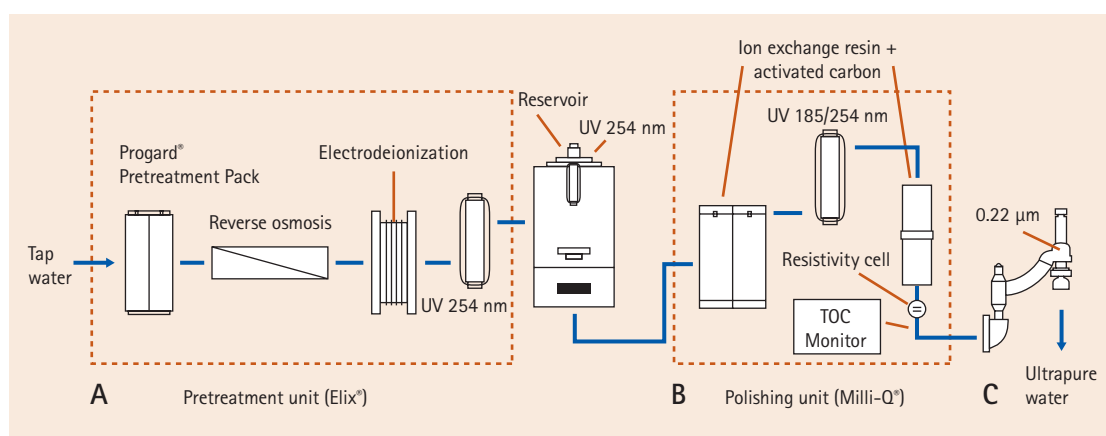

A = Elix® system

B + C = Milli-Q® Advantage A10® system

A + B + C = Milli-Q® Integral system



Benefits of Merck Millipore ultrapure water purification systems

- Range of systems with daily production volumes adapted to your needs: from 1 to 300 L/day
- Ease of pure and ultrapure water dispense, with adjustable flow rate and automatic volume dispense
- Quality exceeding the most stringent norms demand, meeting the requirements of HPLC and UHPLC
- On line Resistivity and TOC monitoring for quality check at the delivery moment
- Full Validation support available to meet cGMP and GLP demands easily
- Low running cost and water waste thanks to proprietary technologies
- Built-in Millitrack® software for immediate and easy access to data
- Flexible installation: on the bench, wall mounted or bench integrated to save laboratory space

► Contact information:
h2o@merckgroup.com

► Analytical HPLC
page 140

► Preparative HPLC
page 400

1 Pretreatment step – pure water purification step

The pure water production step removes the bulk of the contaminants originally present in water to produce water with quality superior to double distilled water. It involves three major technologies: **A.** reverse osmosis, **B.** electrodeionization, and **C.** irradiation with germicidal UV.

A. Reverse osmosis [RO]

Reverse osmosis constitutes an excellent first purification step because it has the ability to remove a fair percentage of the major classes of contaminants present in potable tap water. RO will typically remove more than 97 % of the ions, more than 99 % of organics with molecular weight above 200 Dalton and more than 99 % of the colloids, particulates and bacteria. The RO membrane being sensitive to particulates, chlorine and CaCO₃ deposits, an adequate protection is provided by the Progard® cartridge located upstream of the RO membrane.

B. Electrodeionization [EDI]

The RO purification step is followed by the Elix® module, an electrodeionization [EDI] patented device combining electrodes, selective anionic and cationic permeable membranes, and ion-exchange resins. The ion-exchange resin beads in the EDI module are permanently regenerated by a weak electric current, enabling its operation for several years without any maintenance. The Elix® module is able to remove from the RO permeate most of the remaining inorganic and organic ions.

The combination of RO and EDI is a very powerful pretreatment. It provides Type 2 water on a consistent and reliable basis, with water resistivity typically >10 MΩ.cm and TOC <30 ppb (measured in-line).

C. Germicidal UV

A low pressure mercury lamp, emitting light at 254 nm wavelength, placed at the Elix® module outlet, inactivates micro-organisms and prevent bacterial growth and contamination in the pure water produced, just before storage in the reservoir. An optional programmable 254 nm UV lamp in the reservoir maintains low bacterial contamination in the stored pure water and prevents biofilm development.

Polishing step – ultrapure water production step

2

Pure water momentarily stored in an adequately designed reservoir can be used directly for the glassware washing process, or further purified for critical chromatography applications. Polishing steps typically combine three purification technologies: **A.** ion-exchange resins, **B.** activated carbon, and **C.** UV photo-oxidation, often followed by the use of a final filter at the point of water delivery, i.e. point-of-use.

A. Ion exchange resins

Ion-exchange resins are small (<1.2 mm) polystyrene based porous beads with ion-exchange binding sites covalently bound on the surface and inside the beads. Merck Millipore Jetpore® ion-exchange resins are characterized by high-binding capacity, fast ion exchange kinetics to reach high resistivity and low TOC release. The purpose of ion-exchange resins is to remove ions from the water, producing water with an 18.2 MΩ.cm resistivity.

B. Synthetic activated carbon

The synthetic activated carbon is made of porous beads with a large developed surface (>1000 m²/g) and binds organic molecules on the walls of the pores by Van der Waals forces, π - π or hydrophobic interactions.

C. UV photo-oxidation

A dual-wavelength UV lamp (185 and 254 nm) oxidizes organics dissolved in water, so that they become electrically charged, and are afterwards removed by ion-exchange resins. This technology allows the organics to be decreased to a TOC level below 5 ppb.

The combination of the three polishing technologies described above, ion exchange resins, activated carbon, and UV photo-oxidation, yields water with high resistivity (18.2 MΩ.cm) and low TOC level (<5 ppb).

Point-of-use cartridges

3

Finally, a point-of-use [POU] cartridge is placed at the end of the water purification chain, with two major purposes:

1. removing the contaminants most critical for the experimentation right before water is delivered and used, and
2. preventing retro-contamination of the purification chain from air-borne sources. The final purification cartridge is selected according to the requirements of the instruments or applications used in the laboratory.

Two options are offered for POU cartridges that could be used to produce ultrapure water that is suitable for HPLC, LC-MS, and UHPLC: **A.** 0.22 µm filter and **B.** C18-based cartridge.

A. 0.22 µm screen membrane filter

The 0.22 µm final screen filter retains particles larger than 0.22 µm and bacteria. Merck Millipore membrane filters such as the Millipak® filter have been validated for sterilizing filtration and are delivered with a certificate of quality. This 0.22 µm filter is widely used for the production of water for chromatography applications.

B. C18-based cartridge

In rare cases where small contaminant peaks are still present and are a concern, a cartridge packed with C18 particles can be used (LC-Pak®).

Elix[®] Advantage system

Tap to pure water



Product	Ordering No.
Elix [®] Advantage (3 L/hour), water purification kit, pre-equipped for E-POD [®] unit	ZRXV003WW
Elix [®] Advantage (5 L/hour), water purification kit, pre-equipped for E-POD [®] unit	ZRXV005WW
Elix [®] Advantage (10 L/hour), water purification kit, pre-equipped for E-POD [®] unit	ZRXV010WW
Elix [®] Advantage (15 L/hour), water purification kit, pre-equipped for E-POD [®] unit	ZRXV015WW
E-POD [®] water delivery unit dispenser	ZRXSP0D01
E-POD [®] wall mounting bracket	WMBQP0D01
POD protection in silicone crystal	PODCOVER1
Footswitch for E-POD [®] dispenser	ZMQSFTS01
Water sensor	ZFWATDET4
30-Liter polyethylene pure water storage reservoir	TANKPE030
60-Liter polyethylene pure water storage reservoir	TANKPE060
100-Liter polyethylene pure water storage reservoir	TANKPE100
200-Liter storage and distribution system 200	ZFRE00200
350-Liter storage and distribution system 350	ZFRE00350
Automatic sanitization module for PE tank	TANKASMIN
Wall mounting bracket	WMBSMT002
Lab close kit	LABCLOSE1
E-Gard upgrade kit	ZRXSUPEG1
Clinical upgrade kit	ZRXSUPCL1
UV upgrade kit	ZRXSUPUV1

► Analytical HPLC
page 140

► Preparative HPLC
page 400

Milli-Q® Advantage A10® system

Pure to ultrapure water

Ordering information – Milli-Q® Advantage A10® system

Product	Ordering No.
Milli-Q® Advantage A10® ultrapure water production unit with built-in resistivity and TOC meter, delivered with UV lamps in place	Z00Q0V0WW
Q-POD® ultrapure water delivery unit	ZMQSP0D01
Footswitch for Q-POD® (1/pk)	ZMQSFTS01
Cabinet wall mounting bracket	WMBQP0D01
Water sensor	ZFWATDET4
Q-Gard® T1 pre-treatment pack	QGARDT1X1
Quantum® TEX polishing cartridge	QTUM0TEX1
Millipak® Express 40 0.22 µm final filter	MPGP04001
LC-Pak® reverse phase polisher	LCPAK0001



- ▶ Analytical HPLC
page 140
- ▶ Preparative HPLC
page 400

Milli-Q® Integral system

Tap to pure & ultrapure water



Ordering information – Milli-Q® Integral system

Product	Ordering No.
Milli-Q® Integral 3 pure (3 L/hour) and ultrapure water production unit with built-in resistivity and TOC meter	ZRXQ003WW
Milli-Q® Integral 5 pure (5 L/hour) and ultrapure water production unit with built-in resistivity and TOC meter	ZRXQ005WW
Milli-Q® Integral 10 pure (10 L/hour) and ultrapure water production unit with built-in resistivity and TOC meter	ZRXQ010WW
Milli-Q® Integral 15 pure (15 L/hour) and ultrapure water production unit with built-in resistivity and TOC meter	ZRXQ015WW
PE reservoir designed for optimum storage of pure water (30 L)	TANKPE030
PE reservoir designed for optimum storage of pure water (60 L)	TANKPE060
PE reservoir designed for optimum storage of pure water (100 L)	TANKPE100
Q-POD® ultrapure water delivery unit	ZMQSP0D01
E-POD® pure water delivery unit	ZRXSP0D01
Footswitch for Q-POD® and E-POD® (1/pk)	ZMQSFTS01
Cabinet wall mounting bracket	WMBSMT002
Q-POD® or E-POD® wall mounting bracket	WMBQP0D01
Water sensor	ZFWATDET4
ASM (automatic sanitization module) for prevention of biofilm development inside the 30/60/100 L PE reservoir	TANKASMIN
Progard® S2 pre-treatment pack	PROG0T0S2
Quantum® TEX polishing cartridge	QTUM0TEX1
Millipak® Express 40 0.22 µm final filter	MPGP04001
LC-Pak® reverse phase polisher	LCPAK0001

► Analytical HPLC
page 140

► Preparative HPLC
page 400

LiChropur[®] reagents for analytical HPLC

Ion pair reagents – what are they?

These are strongly hydrophobic ionic compounds, which form neutral ion pairs with oppositely charged sample molecules. In this way, the simultaneous separation of charged and non-charged molecules is possible. LiChropur[®] reagents are manufactured to ensure high UV-transmittance even at low detection wavelengths.

What concentrations are recommended?

In practice, a concentration of 5×10^{-3} mol/L has proved suitable for most applications using short-chain ion pair reagents and 5×10^{-4} mol/L for long-chain ion pair reagents.

How can buffers be prepared?

Instructions for preparing buffer solutions with LiChropur[®] ion pair reagents are included in the product packaging (these instructions may be modified as required by the specific chromatographic method).

Which columns and eluents can be used with these reagents?

They can be used basically with all stationary phases; the eluent should contain at least 10 % water as otherwise there is a danger of precipitation (especially if acetonitrile is the organic component).

When using long-chain ion pair reagents such as cetyltrimethylammonium hydrogen sulfate or the sodium salt of dodecanesulfonic acid, the column used for the separation should be reserved for this exclusive purpose as irreversible adsorption can take place on the stationary phase leading to changes in separation behaviour.

Ordering information – Ion pair reagents for analytical HPLC LiChropur[®]

Product	Ordering No.	Package	Quantity
1-Butanesulfonic acid sodium salt	1.18303.0025	Glass	25 g
1-Pentanesulfonic acid sodium salt	1.18304.0025	Glass	25 g
1-Hexanesulfonic acid sodium salt	1.18305.0025	Glass	25 g
1-Heptanesulfonic acid sodium salt	1.18306.0025	Glass	25 g
1-Octanesulfonic acid sodium salt	1.18307.0025	Glass	25 g
1-Dodecanesulfonic acid sodium salt	1.18308.0025	Glass	25 g
1-Dodecylhydrogensulfate sodium salt	1.18309.0025	Glass	25 g
Tetramethylammonium hydrogen sulfate	1.18310.0025	Glass	25 g
Tetrabutylammonium hydrogen sulfate	1.18312.0025	Glass	25 g
Cetyltrimethylammonium hydrogen sulfate	1.18313.0025	Glass	25 g

Ordering information – Buffer salts for HPLC LiChropur[®]

Product	Ordering No.	Package	Quantity
di-Potassium hydrogen phosphate trihydrate	1.19754.0250	Glass	250 g
di-Sodium hydrogen phosphate dihydrate	1.19753.0250	Glass	250 g



02

Sample Preparation



www.merckmillipore.com/sample-preparation

If you're looking for fresh ways to optimize samples prior to analysis, you've come to the right place. Our innovative, high-quality sample preparation products support a variety of applications in pharmaceuticals, food and beverage production, governmental and academic research, and many more. Environmental sample preparation is another important field where our products excel, for example in water analysis.

02

Contents

Sample Preparation page 48

EXtrelut® NT working principle page 50
Liquid-liquid extraction in its most effective form

EXtrelut® NT1, EXtrelut® NT3 and EXtrelut® NT20 page 51

EXtrelut® NT refill packs and bulk materials page 52

EXtrelut® NT accessories page 53

Important EXtrelut® NT extraction parameters page 54

LiChrolut® page 56

LiChrolut® selection guide page 57

LiChrolut® page 58
Solid-phase extraction (SPE) with LiChrolut® – the reliable and rapid route to successful sample preparation

LiChrolut® EN page 60
Highest capacity for solid-phase extraction

LiChrolut® extraction unit and drying attachment page 64

LiChrolut® operating principle page 65

LiChrospher® ADS	page 66
LiChrospher® ADS For direct on-line sample preparation of untreated bio-fluids	page 68
LiChrospher® ADS working principle	page 70
Ion exchangers and working principle	page 74
Application guide	page 75
Ion exchangers	page 76
Millex® Syringe Filters Filter with confidence	page 80
Millex® Syringe Filters Sample preparation for chromatography	page 81
Membrane Filters Mobile phase preparation for HPLC/UHPLC	page 84
Millex® Syringe Filters Sample preparation for HPLC/UHPLC	page 85
Millex® Syringe Filters Automation-compatible filter	page 88
Samplicity® Filtration System Break free from routine sample filtration	page 90
Samplicity® Filtration System Now you can truly do more with less.	page 92

Sample Preparation

Introduction

Thanks to the development of high performance analytical instruments, highly sensitive detectors and advances in the compilation and collation of measurement data, numerous samples can now be analyzed. However, comprehensive control of the most important parameters is necessary to ensure product quality, prevent damage and maintain the quality of columns.

In order to utilize the possibilities offered by chromatographic analysis, samples must be optimally prepared. This is often the most critical step of the analysis, as well as the most time-consuming. Selective and specific sample preparation ensures rational, economical and meaningful analysis.

Advantages of sample preparation:

- Removal of interfering sample components to avoid blocking of HPLC and GC columns
- Selective enrichment of analytes
- Increased concentration of analytes by a factor of 100 to 5,000

Merck Millipore's broad portfolio of sample preparation products can be first classified into off- and on-line methods.

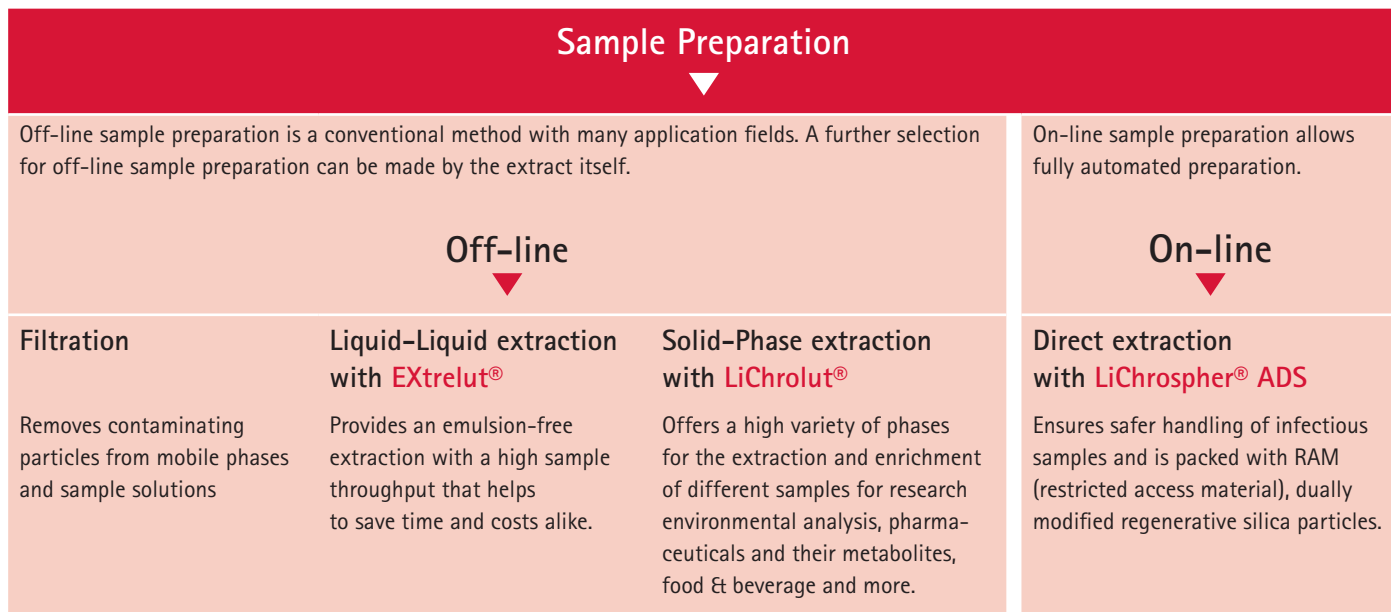

Apart from products for purely mechanical sample preparation procedures, e.g. filtration, we developed the **EXtrelut®** sorbents and columns specially for sample preparation of aqueous matrices; thus we introduced the efficient method of liquid-liquid extraction. With the **LiChrolut®** sorbents and extraction columns for solid-phase extraction, a further efficient alternative to classical extraction using a separating funnel is available. **LiChrospher® ADS** represents the third line of products for sample preparation, namely LC-integrated sample preparation, which can help to reduce the needed time for sample preparation dramatically.

An essential component of high quality separation and purification processes, **Millex® Syringe Filters** can be found in virtually every laboratory. The **Samplivity® Filtration System** is designed to filter up to 8 samples directly into standard HPLC vials.



EXtrelut[®] NT working principle

Liquid-liquid extraction in its most effective form

Classical extraction using a separation funnel is often associated with certain disadvantages: Formation of emulsion, poor phase separation, high solvent consumption, low degree of automation and high personnel costs. EXtrelut[®] NT simplifies liquid-liquid extraction by replacing separation funnels. Using a single step is more efficient, saves solvent, as well as material and time in contrast to classical funnel separation.

Benefits of EXtrelut[®] NT

- Saves solvent
- Easy-to-use
- Highly efficient

With its easy-to-use working principle a higher recovery and cleaner extraction can be achieved. The aqueous sample is simply applied to the EXtrelut[®] NT sorbent. It distributes itself in the form of a thin film over the chemically inert matrix and thus acts as a stationary phase.

Subsequently, elution takes place using organic solvents that are non miscible with water, solvents like e.g. diethyl ether, ethyl acetate or halogenated hydrocarbons. All the lipophilic substances are extracted from the aqueous into the organic phase. During this process the aqueous phase remains on the stationary phase. The eluate is free from emulsions and can be evaporated for further analysis.

Specifications of EXtrelut[®] NT

Characteristics	Specially processed, wide-pore kieselguhr with a high pore volume Chemically inert Naturally occurring product		
Capacity limit with aqueous sample	EXtrelut [®] NT1	1 mL	without any breakthrough
	EXtrelut [®] NT3	3 mL	
	EXtrelut [®] NT20	20 mL	
pH range	pH 1-10		
Uniform batch-to-batch quality			

Please review also our important extraction parameters – page 54.

The working principle of EXtrelut[®] NT

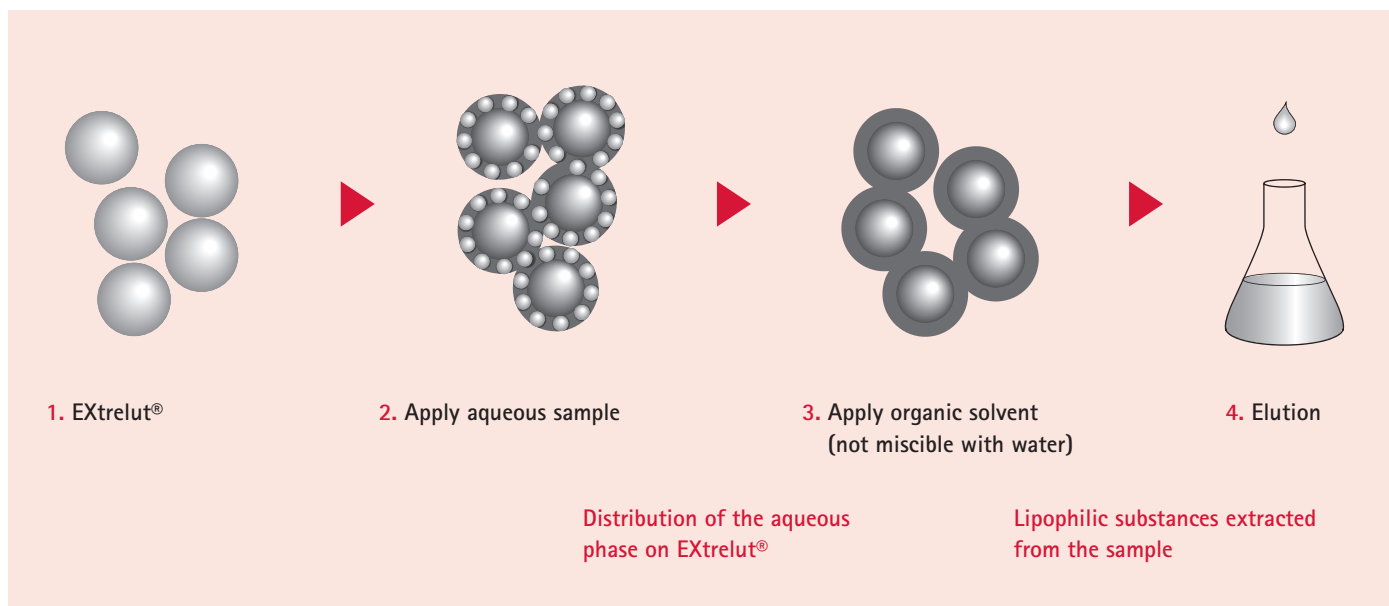

EXtrelut[®] NT1, EXtrelut[®] NT3 and EXtrelut[®] NT20

The capacity of EXtrelut[®] NT pre-packed columns for aqueous samples are specified by the designation

EXtrelut [®] NT1	EXtrelut [®] NT3	EXtrelut [®] NT20
can take up a maximum of 1 mL of aqueous sample	can take up a maximum of 3 mL of aqueous sample	can take a maximum of 20 mL of aqueous sample

Significantly smaller samples must be appropriately diluted. If larger volumes are applied, the columns are overloaded; water breaks through into the solvent. Elution is carried out with 2–3 times the sample volume. The liquid may simply be allowed to run through the column. The column outlet cannula regulates the solvent flow appropriately.

Ordering information – EXtrelut[®] NT pre-packed columns

Product	Ordering No.	Contents of one package
EXtrelut [®] NT1 glass columns for 0.1 to 1 mL sample solution	1.15094.0001	100 columns
EXtrelut [®] NT3 glass columns for 1 to 3 mL sample solution	1.15095.0001	50 columns
EXtrelut [®] NT20 polyethylene columns including special outlet cannulae for up to 20 mL sample solution	1.15096.0001	25 columns

These products are not intended for use as in-vitro diagnostics in terms of European Directive 98/79/EC. They are for research purposes only, for investigating in-vitro samples derived from the human body without any medical objective.

EXtrelut[®] NT refill packs and bulk materials

Ordering information – EXtrelut[®] NT packing material

Product	Ordering No.	Contents of one package
EXtrelut [®] NT bulk packing for preparing large-volume columns	1.15092.1000	1 kg
EXtrelut [®] NT refill packs for refilling 50 EXtrelut [®] NT20 columns (incl. replacement filters)	1.15093.0001	50 bags

These products are not intended for use as in-vitro diagnostics in terms of European Directive 98/79/EC. They are for research purposes only, for investigating in-vitro samples derived from the human body without any medical objective.



*EXtrelut[®] NT – liquid-liquid extraction
in its most effective form*



EXtrelut[®] NT accessories



EXtrelut[®] NT collection tube for EXtrelut[®] NT1 and EXtrelut[®] NT3 glass columns

Ordering information – EXtrelut[®] NT accessories

Product	Ordering No.	Contents of one package
EXtrelut [®] NT accessories cannulae 0.60/30 with Luer tip for EXtrelut [®] NT1 and EXtrelut [®] NT3	1.15373.0001	100 pieces
EXtrelut [®] NT collection tubes with tapered bottom and screw cap (normal capacity 15 mL) for EXtrelut [®] NT1 and EXtrelut [®] NT3	1.15622.0001	30 pieces
Replacement filter for EXtrelut [®] NT1 (10 mm Ø)	1.14236.0001	100 pieces
Replacement filter for EXtrelut [®] NT3 (15 mm Ø)	1.14237.0001	100 pieces
Replacement filter for EXtrelut [®] NT20 (24 mm Ø)	1.14567.0001	50 pieces

Important EXtrelut® NT extraction parameters

Important EXtrelut® NT extraction parameters

EXtrelut NT® extraction columns	Outlet cannulae	Maximum sample volume ¹⁾ [mL]	Waiting period ²⁾ (before elution) [min]	Recommended elution volume ³⁾ [mL]
EXtrelut® NT1	0.60 x 30 mm	1	5 – 10	6
EXtrelut® NT3	0.60 x 30 mm	3	5 – 10	15
EXtrelut® NT20	0.70 x 30 mm	20	10 – 15	40

1. In order to prevent that water breaks through the sample, don't overload the column.
2. Shorter waiting times can affect the recoveries adversely.
3. The recommended sample volumes must be adhered to. Solutions of smaller volumes must be diluted to give indicated volumes.

Application example of EXtrelut® NT

EXtrelut® NT has been used for quite some time within research, for the sample preparation of urine, whole blood, plasma, serum, gastric juice, liquor, amniotic fluid, faeces, animal and plant tissue. Other applications are in the areas of environmental and residue analysis, e.g. the analysis of industrial, domestic and waste water. The fractionated elution of acidic and basic substances (e.g. drugs and their metabolites) from body fluids is also possible.

Determination of antiepileptic drugs (AEDs) in serum

500 µL serum
500 µL phosphate buffer*

▼ Apply in sequence onto the column

EXtrelut® NT1

▼ Wait 8 minutes

1 mL dichloromethane /
2-propanol (9+1)

▼ Wait 10 minutes then elute with

6 mL dichloromethane /
2-propanol (9+1)

▼ Evaporate to dryness under nitrogen stream

Redissolve residue in 1 mL of methanol

▼

Inject 10 µL into HPLC column

* 17.6 g NaH₂PO₄, 4.5 g Na₂HPO₄, 2 H₂O, 1.5 g NaN₃, dissolve in 1 L water (pH 6.0–6.1)

HPLC separation of AEDs after sample preparation with EXTrelut® NT1

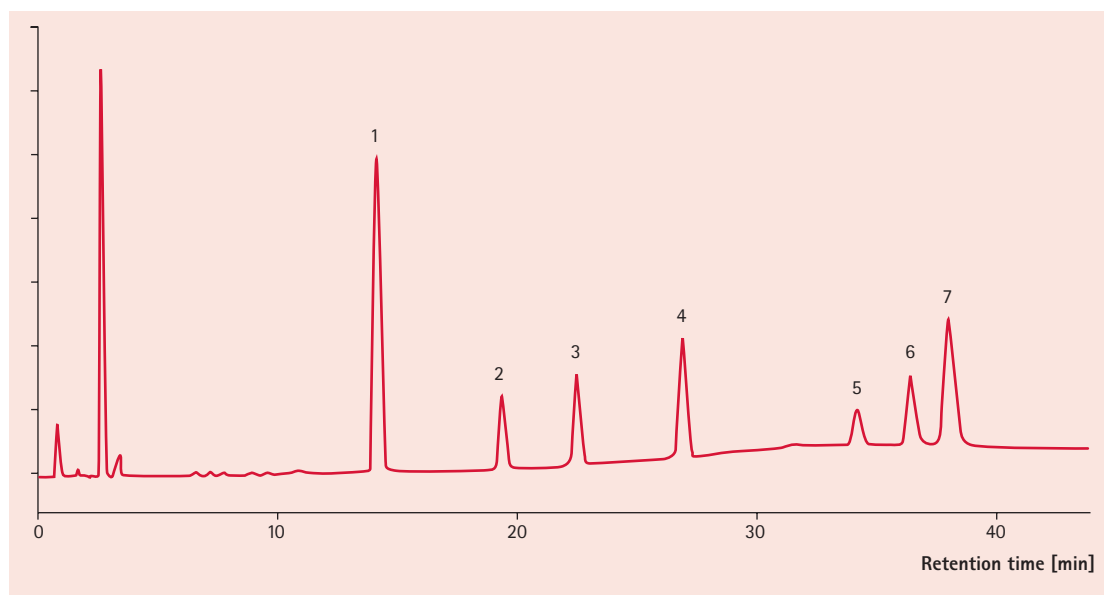

HPLC conditions

HPLC	LaChrom® system		
Column	LiChrospher® RP-select B (5 µm) LiChroCART® 250-4		
Mobile phase	A: Water LiChrosolv® Acetonitrile LiChrosolv® (1+1) B: Water LiChrosolv®		
Gradient	Time [min]	% A	% B
	0	10	90
	30	60	40
	44	60	40
	44.1	100	0
	50	100	0
	51	10	90
	75	10	90
Flow	1 mL/min		
Temperature	30°C		
Detection	UV 205 nm		

Recoveries [mean values N = 3]

1	Ethosuximide*	14.1 min	84 ± 7 %
2	Primidone	19.4 min	100 ± 2 %
3	a-Methyl-a-propylsuccinimide	22.5 min	Internal standard
4	Phenobarbital	26.9 min	96 ± 2 %
5	Hexobarbital	34.2 min	99 ± 2 %
6	Carbamazepine	36.4 min	97 ± 1 %
7	Phenytoin	38.0 min	100 ± 1 %

* ethosuximide is volatile on evaporation

Solid-phase extraction (SPE) with LiChrolut® – the reliable and rapid route to successful sample preparation

The primary goal of solid-phase extraction with LiChrolut® is the selective extraction of the components of interest from a complex sample or much larger sample volume prior to actual analysis (e.g. HPLC, GC, TLC). As solid-phase extraction works on the principle of liquid chromatography, this is achieved by using strong but reversible interactions between the analyte and surface of the stationary phase. Typical interactions are e.g. hydrophobic (Van-der-Waals forces), polar (hydrogen bonding, dipole-dipole forces) or ion exchange interactions. Interaction between stationary phase and matrix should not occur.

It is thus meaningful to carry out appropriate sample pretreatment as this emphasizes the differences in chemical properties between the substance to be analyzed and matrix components so that these are then achieved by altering the pH or the ionic strength of the sample solution. Under these conditions, the analyte is enriched as a narrow zone on the stationary phase. Subsequent to a washing step, which serves to remove possible adsorbed sample components, the actual selective elution of the analytes takes place.

Benefits in working with LiChrolut®

- Saves time and solvent
- Higher recoveries without the formation of emulsion.
- High precision of analytical results by use of disposable cartridges.
- Optimized, validated and certified manufacturing with the possibilities for automating the entire process.

Specifications of LiChrolut®

Characteristics	High porosity synthetic silica gel particles
Particle size	40-63 µm
Pore size	60 Å
Specific surface area	~ 600 m ² /g
Stability	pH 2-8
Wide spectra of chemically modified phases	Si 60 high purity, NH ₂ , CN, RP-18e, RP-18, SCX (Strong Cation Exchanger), TSC (Tox Screening Cation)

Specifications of Florisil®

Characteristics	Magnesia-loaded silica gel
Particle size	150-250 µm

► LiChrolut® EN
Highest capacity for
solid-phase extraction
page 60

LiChrolut[®] selection guide

For optimal choice of the extraction method, extensive knowledge of the analyte and sufficient information regarding structure, solubility, polarity and lipophilic properties (distribution coefficients) are necessary. In order to achieve best results you find below our selection guide. It contains information about the typical applications for each LiChrolut[®] product. If you do not find what you are looking for, please review our Analytical Application Finder under www.merckmillipore.com/aaf or simply contact us.

Application	LiChrolut [®] extraction column	Typical sample matrix	Typical sample substances	Typical elution solvent
Non-polar extraction	RP-18 RP-18e (endcapped) CN	Aqueous buffer solution	Aromatic ring systems, compounds with alkyl chains, aromatic ring systems	Acetonitrile, methanol, ethyl acetate
Polar extraction	Si CN	Hexane, oils, chlorinated hydrocarbons	Hydroxyl groups, amines, compounds with hetero atoms (S,N,O)	Methanol, 2-propanol
Cation exchange extraction	SCX (strong)	Methanolic/aqueous buffer with low ionic strength; 2 pH units under pK value of the sample substance	Cations: amines, pyrimidines	Aqueous buffer of high ionic strength (0.1 mol/L); 2 pH units over pK value of the sample substance
Mixed mode extraction	TSC	Body fluids*	Cationic and neutral analytes	Chloroform-acetone, NH ₃ -ethyl-acetate or NH ₃ -methanol
Non-polar extraction on a polymer phase	EN	Drinking, ground and surface water	Polar contaminants: pesticides, phenols, explosives, anilines	Ethyl acetate, methanol, acetonitrile:methanol (1:1)
Non-polar extraction on a polymer phase	EN	Body fluids*	Pharmaceuticals	Acetonitrile, methanol
Medium polar extraction of environmental pollutants	Florisil [®]	Waste/ground/drinking water, soil samples	Herbicides, pesticides, PCBs, PCPs, dioxins, phenols, nitro compounds, HCHs	n-Hexane, dichloromethane

* These products are not intended for use as in-vitro diagnostics in terms of European Directive 98/79/EC. They are for research purposes only, for investigating in-vitro samples derived from the human body without any medical objective.

LiChrolut®

Solid-phase extraction (SPE) with LiChrolut® –
the reliable and rapid route to successful sample preparation

Ordering information – LiChrolut®

Product	Ordering No.	Filling amount	Tube size	Contents of one package
LiChrolut® CN (40-63 µm)	1.19698.0001	200 mg	3 mL PP	50 pieces
LiChrolut® EN (40-120 µm)	1.19693.0001	200 mg	3 mL glass	30 pieces
LiChrolut® EN (40-120 µm)	1.19870.0001	200 mg	3 mL PP	30 pieces
LiChrolut® EN (40-120 µm)	1.19691.0001	500 mg	6 mL PP	30 pieces
LiChrolut® EN / RP-18 (top)	1.19912.0001	100 / 200 mg	6 mL PP	30 pieces
LiChrolut® EN (40-120µm)	1.19941.0001	200 mg	6 mL PP	30 pieces
Florisil® (150-250 µm)	1.19127.0001	1,000 mg	6 mL PP	30 pieces
LiChrolut® RP-18 (40-63 µm)	1.19855.0001	100 mg	1 mL PP	100 pieces
LiChrolut® RP-18 (40-63 µm)	1.02014.0001	200 mg	3 mL PP	50 pieces
LiChrolut® RP-18 (40-63 µm)	1.02023.0001	500 mg	3 mL PP	50 pieces
LiChrolut® RP-18 (40-63 µm)	1.19687.0001	500 mg	6 mL PP	30 pieces
LiChrolut® RP-18 (40-63 µm)	1.02122.0001	1,000 mg	6 mL PP	30 pieces
LiChrolut® RP-18 (40-63 µm)	1.19686.0001	2,000 mg	6 mL PP	30 pieces
LiChrolut® RP-18e (40-63 µm)	1.19847.0001	200 mg	3 mL PP	50 pieces
LiChrolut® RP-18e (40-63 µm)	1.19849.0001	500 mg	3 mL PP	50 pieces
LiChrolut® SCX (40-63 µm)	1.02016.0001	200 mg	3 mL PP	50 pieces
LiChrolut® SCX (40-63 µm)	1.02022.0001	500 mg	3 mL PP	50 pieces
LiChrolut® Si (40-63 µm)	1.02021.0001	200 mg	3 mL PP	50 pieces
LiChrolut® Si (40-63 µm)	1.02024.0001	500 mg	3 mL PP	50 pieces
LiChrolut® TSC (40-63 µm)	1.19767.0001	300 mg	3 mL PP	50 pieces

These products are not intended for use as in-vitro diagnostics in terms of European Directive 98/79/EC. They are for research purposes only, for investigating in-vitro samples derived from the human body without medical objective.

Application example: Chlorophylls & Xanthenes in Alga – separation of pigments

The removal of interfering sample compounds to avoid blocking of HPLC and GC columns is a advantage of sample preparation.

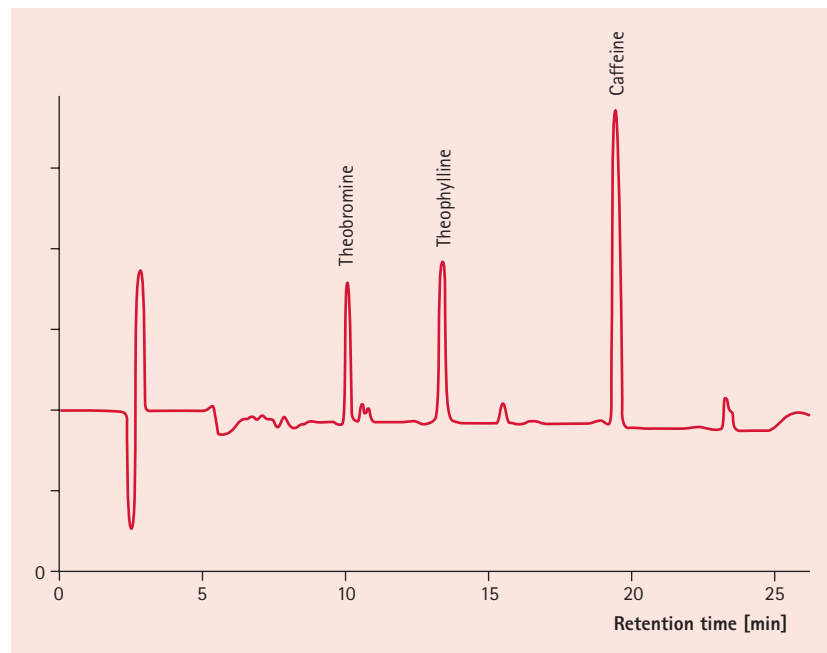

Sample preparation

Extraction column	LiChrolut® RP-18 (500 mg, 3 mL)
Preparation of algal extracts	Filtration of a defined volume of algal suspension (e.g. 50 mL in the case of Pavlova lutheri) by using a Whatman GF/C glass fibre filter (Æ 2.5 or 4.7 cm). Reject the filtrate. Extract the filter for 24 h with 5 mL of A
Solvents	A: Acetone B: Acetone / Water (1/1) C: Water
Conditioning	One column volume A; Three column volume B; Do not allow column to dry out!
Sample injection	Inject 2 mL of sample (50 % Acetone) onto the conditioned extraction column by using weak vacuum
Cleaning step	One column volume C
Elution	Elute once with 1.5 mL A; subsequently filter sample into a vial through a 0.2 µm membrane filter

Chromatographic conditions

Column	LiChrospher® 100 RP-18 endcapped (5 µm) LiChroCART® 250-4			
Precolumn	LiChrospher® 100 RP-18 endcapped (5 µm) LiChroCART® 4-4			
Mobile phase	A: Methanol / Ammonium acetate, 0.5 mol/L, pH = 7.2 (80/20, v/v) B: Acetonitrile / Water (90/10, v/v) C: Ethyl acetate			
Gradient	Time [min]	% A	% B	% C
	0	100	0	0
	2	0	100	0
	2.6	0	90	10
	13.6	0	65	35
	16	0	50	50
	18.5	0	25	75
	23	0	25	75
	26	0	30	70
	30	0	50	50
	35	0	100	45
	45	100	0	0
	60	100	0	0
Flow rate	1 mL/min			
Temperature	Ambient temperature			
Detection	UV 436 nm			
Inject. volume	20 µL			

LiChrolut® EN

Highest capacity for solid-phase extraction

LiChrolut® EN was especially developed for application in environmental analysis where highly contaminated samples occur and very polar organic compounds have to be analyzed. In comparison to LiChrolut® RP-18, LiChrolut® EN has a tenfold higher capacity. Thus, only 200 mg of sorbent is sufficient for reproducible extractions and high recovery rates.

Benefits in working with LiChrolut® EN

- Use of common organic solvents, buffer solutions, acids and bases over the entire pH-range.
- Saving of solvent, as little solvent is required for conditioning and elution of the cartridge bed.
- Time saving, as less adsorbent requires less time for conditioning and drying.
- Improved analysis, as the reduced quantity of solvent required for elution leads to a lower degree of contamination and to an increase in detection sensitivity.

Specifications of LiChrolut® EN

Sorbent type	Ethyl vinyl benzene divinyl benzene polymer (orange)
Particle shape	Irregular
Particle size distribution	40 – 120 µm
Specific surface	1,200 m ² /g (according to BET)
Pore volume	0.75 mL/g
Stability	pH 1 – 13
Capacity	500 mg Caffeine/g sorbent (model substance for polar analytes) 500 mg Diisodecylphthalate DIDP/g sorbent (model substance for nonpolar analytes)

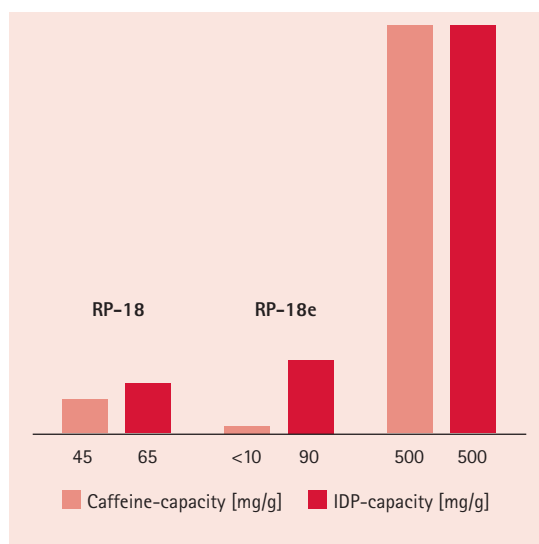

Capacity of LiChrolut® EN

Ensured capacity of LiChrolut® EN in comparison to LiChrolut® RP phases. The increase of sorbent capacity **(by a factor of at least 10)** in comparison to commonly used C-18 sorbent means that only 200 mg of LiChrolut® EN are necessary for the complete enrichment of different contaminants from water.

Ordering information – LiChrolut® EN columns

Product	Ordering No.	Filling amount	Tube size	Contents of one package
LiChrolut® EN (40-120 µm)	1.19693.0001	200 mg	3 mL glass	30 pieces
LiChrolut® EN (40-120 µm)	1.19870.0001	200 mg	3 mL PP	30 pieces
LiChrolut® EN (40-120 µm)	1.19941.0001	200 mg	6 mL PP	30 pieces
LiChrolut® EN (40-120 µm)	1.19691.0001	500 mg	6 mL PP	30 pieces
LiChrolut® EN (40-120 µm) / LiChrolut® RP-18 (40-63 µm) [top]	1.19912.0001	100 mg / 200 mg	6 mL PP	30 pieces

These products are not intended for use as in-vitro diagnostics in terms of European Directive 98/79/EC. They are for research purposes only, for investigating in-vitro samples derived from the human body without any medical objective.

Ordering information – LiChrolut® EN columns

Product	Ordering No.	Contents of one package
LiChrolut® EN for environmental analysis	1.19853.0020	20 g

Application of LiChrolut® EN – Sample preparation of drinking water samples

Anilines pH 9 with NaOH	Explosives pH 5.5 – 6.0	Solid phase extraction LiChrolut® EN 200 mg, 3 mL	Pesticides pH 5.5 – 6.0	Phenols pH 2 with 25 % HCl
3 mL ethyl acetate 3 mL methanol 3 mL water	3 mL methanol 3 mL water	conditioning	3 mL methanol 3 mL water	3 mL ethyl acetate 9 mL water, pH 2
1000 mL sample within 2 h	1000 mL sample within 2 h	sample application	1000 mL sample within 2 h	1000 mL sample within 2 h
1 mL water 1 min with nitrogen	not required not required	wash dry	1 mL water 10 min with nitrogen	1 mL water, pH 2 5 min with nitrogen
2 x 1.5 mL methanol/ acetonitrile/acetone (50/50/1)	2 x 1.5 mL acetonitrile/ methanol (50/50)	elution	2 x 3 mL methanol/ ethyl acetate (50/50)	3 x 0.3 mL ethyl acetate

Typical applications LiChrolut® EN

General remark	Mixed polarity copolymer perfectly suited for: <ul style="list-style-type: none"> • Mixed polar analytes (sorbent provides both polar and non-polar interaction sites) • Trace analysis (extremely high surface area of 1200-1400 m²/g) • Extreme pH conditions (sorbent stability from pH 1-13)
Typical analytes	Environmental pollutants: Fungicides, herbicides, phenols, pesticides, parabens and hydrocarbons Food & beverage: Dyes, essential oils, organic acids, fat/water soluble vitamins, steroids, phthalate esters, surfactants, theophylline. Pharma: Antibiotics, barbiturates, benzodiazepines, caffeine, drugs and their metabolites
Typical matrix	Polar, aqueous buffer, serum, plasma, urine, beverages, environmental samples (waste/drinking water, soil)
Typical eluent	Organic solvent, alcohols, acetonitrile, hexane, methylene chloride, ethyl acetate

Pesticide recovery rates of samples of tap water [N = 10]
containing the 33-multicomponent standard [c = 200 ng/L per pesticide]

Pesticide 1. – 17.	Recovery rate ± rsd [%]	Time [min]	Pesticide 18. – 33.	Recovery rate ± rsd [%]	Time [min]
1. Desisopropylatrazine	100 ± 2.7	6.5	18. Metobromuron	99 ± 3.2	38.6
2. Metamitron	98 ± 1.4	9.2	19. Metazachlor	108 ± 5.6	40
3. Chloridazon	96 ± 1.8	10.1	20. Methoprotryne	99 ± 3.8	40.9
4. Desethylatrazine	101 ± 2.6	10.6	21. Dimefuron	100 ± 1.7	41.6
5. Crimidine	86 ± 3.2	18.9	22. Sebutylazine	99 ± 1.7	42.3
6. Carbetamide	87 ± 3.8	19.7	23. Propazine	102 ± 1.9	42.9
7. Bromacil	103 ± 3.4	21.2	24. Terbutylazine	98 ± 1.5	46
8. Simazine	99 ± 1.7	23.7	25. Linuron	97 ± 1.9	47.1
9. Cyanazine	100 ± 1.9	24.3	26. Chloroxuron	101 ± 1.1	49.4
10. Desethylterbutylazine	95 ± 2.2	26.1	27. Prometryne	95 ± 2.3	51.7
11. Karbutilate	82 ± 4.7	27.3	28. Chlorpropham	101 ± 2.8	52.4
12. Methabenzthiazuron	94 ± 2.4	32.5	29. Terbutryne	96 ± 1.6	53.9
13. Chlortoluron	100 ± 2.5	33.1	30. Metolachlor	102 ± 1.5	55.1
14. Atrazine	100 ± 3.8	33.7	31. Pencycuron	91 ± 2.5	66.3
15. Monolinuron	98 ± 1.8	35.7	32. Bifenox	102 ± 4.1	68.3
16. Isoproturon	101 ± 3.8	36.3	33. Pendimethalin	98 ± 5.0	77.2
17. Diuron	102 ± 5.0	37.1			

Application example: Pesticides in drinking water

The primary goal of solid-phase extraction with LiChrolut® is the selective extraction of the components of interest from a much larger sample volume prior to the actual analysis. LiChrolut® EN was especially developed for applications in environmental analysis.

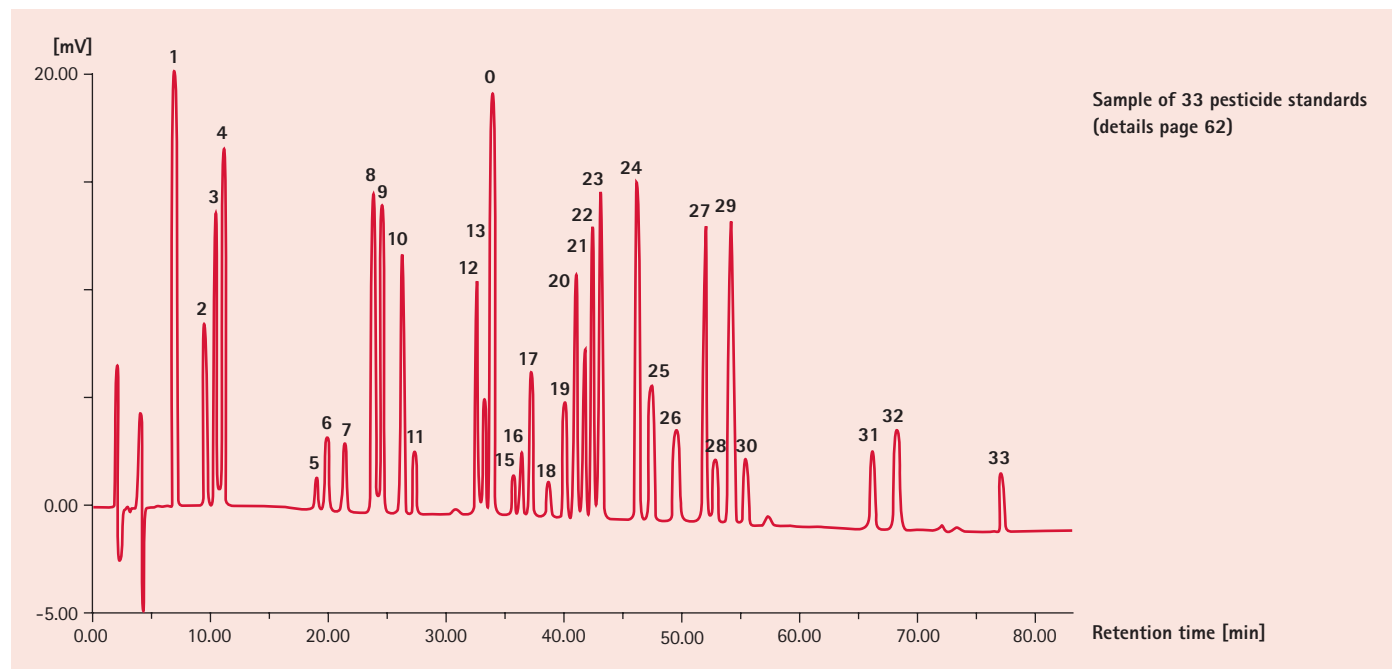

Chromatographic conditions

Column	Superspher® 100 RP-18 (4 µm) LiChroCART® 250-4	
Precolumn	LiChrospher® 100 RP-18 (5 µm) LiChroCART® 4-4	
Mobile phase	A: Acetonitrile B: Ammonium acetate 1 mmol/L	
Gradient	0-10 min	25 % A
	10-70 min	25-70 % A
	70-90 min	70-90 % A
	90-100 min	90 % A
	100-101 min	90-25 % A
	101-121 min	25 % A
Flow rate	0.7 mL/min	
Temperature	28°C	
Detection	DAD UV detection (200-320 nm); Spectral bandwidth 4 nm	
Inj. volume	100 µL	

Sample preparation

Extraction column	LiChrolut® EN (3 mL, 200 mg)
Solvents	A: Methanol B: Ethyl acetate C: Water D: Acetonitrile
Sample preparation	Filter if necessary
Conditioning	One column volume A; one column volume C; Do not allow to dry out
Sample injection	Inject 1 L water sample on to the extraction column, using the LiChrolut® extraction unit, which is connected to the sample with PTFE hose and steel capillary. It is injected on to the column under weak vacuum
Drying	By means of nitrogen (10 min, 2-3 bar) combining the drying unit with the extraction unit
Elution step	Elute twice with 3 mL A/B (1/1, v/v) collect in a 10 mL volumetric flask, strip solvent by using N ₂ . Redissolve residue by adding 250 µL D and bring to start conditions of the HPLC by adding 750 µL C. Subsequently filter sample into 1.5 mL sample vials through a 0.2 µm membrane filter

LiChrolut[®] extraction unit and drying attachment

All the individual steps associated with solid-phase extraction can be carried out using the LiChrolut[®] extraction unit rapidly and reliably. This transparent and vacuum-suitable unit made of glass can be used to prepare up to 12 samples simultaneously.

Your benefits

- Control of the vacuum via a manometer located at the front.
- Individual and easy setting of the various flow rates using valves.
- Glass vessel, lid and standard accessories consist of inert and easily cleaned materials.
- Standard accessories enable various sized collection vessels from volumetric flasks to autosampler vials to be used.



Ordering information – LiChrolut[®] extraction unit and drying attachment

Product	Ordering No.	Contents of one package
LiChrolut [®] extraction unit, complete	1.19851.0001	1 lid with 12 standard valves and seal, 1 glass chamber with gauge and vacuum valve, 12 standard stainless steel cannules, 1 collecting rack (base plate with 3 support rods, center plate, top plate with 10 mm boring and 12 clamps), 1 rack for volumetric flasks, 1 rack for test tubes 16 mm, 1 rack for autosampler vials
LiChrolut [®] drying attachment, complete	1.19852.0001	1 piece
Disposable fluoroplastic liners	1.19874.0001	100 pieces
Large volume capillaries	1.19902.0001	6 pieces stainless steel, electro-polished 2.0 o.d. x 1,5 i.d. x 300 mm lg
PTFE adapter Adapter (PTFE) Luer inlet for solvent reservoir, suitable for LiChrolut [®] columns of various sizes	1.02206.0001	10 pieces for 119828 and 119878 and all 1 and 3 mL PP SPE columns
Frits (PTFE) for 3 mL glass columns, porosity 10 µm	1.19891.0001	100 pieces

LiChrolut[®] operating principle

Four steps are necessary for solid-phase extraction

These should be optimized in order to obtain maximum recovery.

1. Conditioning the sorbent

In the case of chemically modified silica gels, solvation with an organic solvent (acetonitrile or methanol) is necessary prior to the actual conditioning i.e. the preparation of the sorbent for the sample milieu with water or buffer solution (in order to be accessible for the analyte). This is a pre-requisite for reproducible sorption of the analyte. Excess organic solvent is removed using water or a buffer solution.

2. Application of the sample

The sample solution is forced by vacuum or pressure through the conditioned extraction cartridge. In this process the substance to be analyzed concentrates itself as a narrow zone on the sorbent. In the ideal case no matrix components will be adsorbed and run through the extraction cartridge to waste.

3. Washing

Other interfering matrix components are removed from the surface of the stationary phase with a small volume of water or buffer. A water buffer mixture containing a small quantity of methanol can also be used.

4. Elution of adsorbed analytes

In this final step of solid-phase extraction, the substance to be analyzed is desorbed with a suitable solvent and eluted as a narrow zone. Subsequent to concentration or dilution of the eluate, analysis can follow immediately. The solvent should be so selected that the reaction between analyte and sorbent is weakened and a distribution of the analyte throughout the eluent takes place. Thus, for optimal choice of the solvent, extensive knowledge of the analyte and sufficient information regarding structure, solubility, polarity and lipophilic properties (distribution coefficients) are necessary.

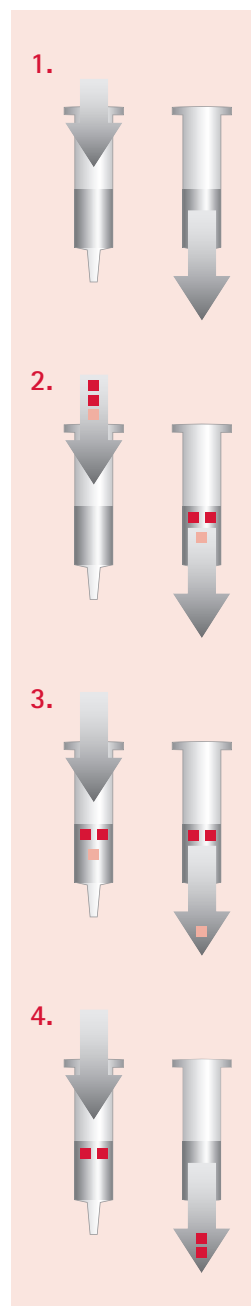

- Interfering matrix components
- Substance to be determined

► **LiChrolut[®] selection guide** providing more details on this general principle and more specific information for non-polar, polar and ionic compounds.
page 57

LiChrospher® ADS

LiChrospher® ADS allows the direct extraction and enrichment of hydrophobic, low molecular weight analytes from untreated samples such as haemolysed blood, plasma, serum, milk, salivary fluid, fermentation broth, supernatants of cell cultures and tissue as well as food homogenates.

LiChrospher® ADS sorbents belong to the family of restricted access materials (RAM) with two chemically different surfaces, a hydrophilic external surface and a hydrophobic inner surface. Extraction and fractionation is based on the simultaneous performance of two chromatographic processes: reversed phase/ion-pair chromatography and size exclusion chromatography.

Specifications of LiChrospher® ADS

Sorbent characteristic	Spherical silica gel particles with two chemical different surface modifications	
Surface modifications	1. Exterior surface 2. Interior surface (surface of pores)	DIOL modification C-4, C-8, or C-18 modification
ADS	Alkyl-DIOL-Silica	
Particle size	25 µm	
Pore diameter	60 Å (6 nm)	
Stability	pH 2-7.5	

Analysis with LiChrospher® ADS

The task	<ul style="list-style-type: none">• HPLC analysis of low molecular weight compounds (e.g. drugs, metabolites) in biological samples such as blood, plasma, serum, milk, fermentation broth, supernatants of cell culture or tissue homogenates.• Remove macromolecular compounds (e.g. proteins) prior to HPLC-analysis, as they are irreversibly bound or precipitated.
This leads to	<ul style="list-style-type: none">• Irreversible increase in back-pressure• Loss of capacity• Drop in selectivity• Serious damage of HPLC column
The solution	<p>LiChrospher® ADS</p> <ul style="list-style-type: none">• Especially designed as precolumn packing(s) for coupled-column LC-analysis• Outer particle surface is non-adsorptive towards matrix components due to its electroneutral and hydrophilic modification• Inner pore surface is accessible only for low molecular compounds (MW <15000 Dalton) and retention (extraction, enrichment) is due to classical (conventional) RP-partitioning• Extraction and enrichment can be optimized by using either C-18, C-8 or C-4 modified LiChrospher® ADS

Benefits in working with LiChrospher® ADS compared to conventional "off-line" sample preparation

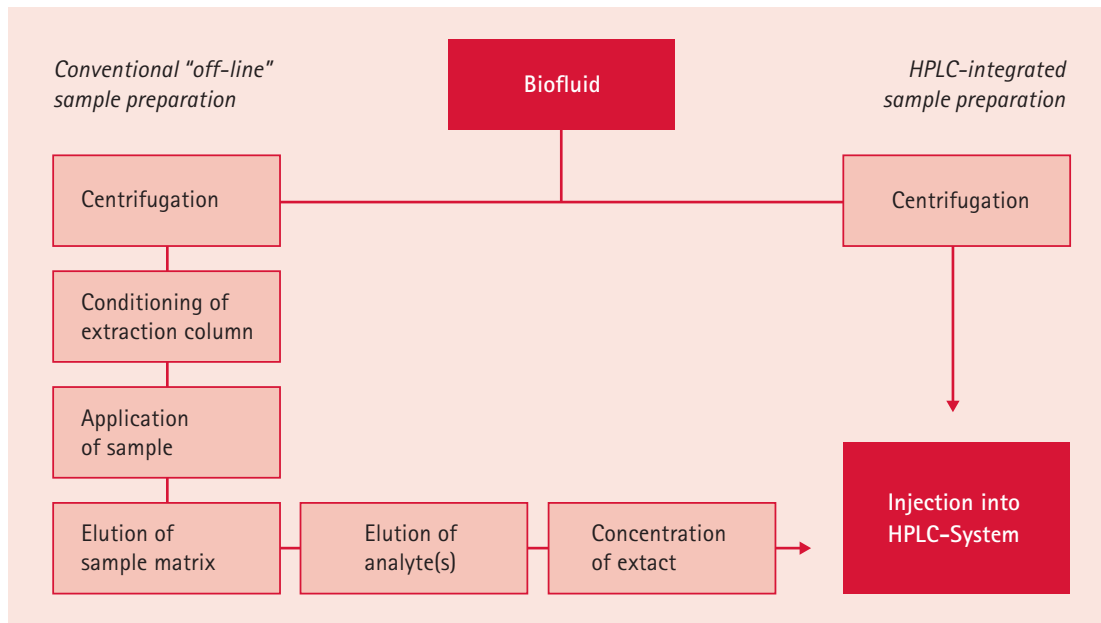

Benefits of LiChrospher® ADS at a glance

- Saves money and time: The high amount of analysis cycles, the direct injection of untreated biological fluids, and the fully automated system, extends column lifetime as well as saving time significantly
- Improved precision, accuracy, and sensitivity
- Quantitative elimination of protein matrix
- On-column enrichment of analytes



*LiChrospher® ADS
for direct on-line sample preparation*

LiChrospher® ADS

For direct on-line sample preparation of untreated bio-fluids

Ordering information – LiChrospher® RP-4 ADS

Product	Ordering No.	Particle size	Dimension length	Dimension i.d.	Contents of one package
LiChrospher® RP-4 ADS	1.50380.0001	25 µm	25 mm	2 mm	1 piece
LiChrospher® RP-4 ADS	1.50381.0001	25 µm	25 mm	2 mm	3 pieces
LiChrospher® RP-4 ADS	1.50208.0001	25 µm	25 mm	4 mm	3 pieces
LiChrospher® RP-4 ADS cartridge set	1.50206.0001	25 µm	25 mm	4 mm	1 LiChroCART® 25-4 LiChrospher® RP-4 ADS 1 manu-CART® holder 25-4

These products are not intended for use as in-vitro diagnostics in terms of European Directive 98/79/EC. They are for research purposes only, for investigating in-vitro samples derived from the human body without any medical objective.

Ordering information – LiChrospher® RP-8 ADS

Product	Ordering No.	Particle size	Dimension length	Dimension i.d.	Contents of one package
LiChrospher® RP-8 ADS	1.50382.0001	25 µm	25 mm	2 mm	1 piece
LiChrospher® RP-8 ADS	1.50209.0001	25 µm	25 mm	4 mm	3 pieces
LiChrospher® RP-8 ADS cartridge set	1.50207.0001	25 µm	25 mm	4 mm	1 LiChroCART® 25-4 LiChrospher® RP-8 ADS 1 manu-CART® holder 25-4

These products are not intended for use as in-vitro diagnostics in terms of European Directive 98/79/EC. They are for research purposes only, for investigating in-vitro samples derived from the human body without any medical objective.

Ordering information – LiChrospher® RP-18 ADS

Product	Ordering No.	Particle size	Dimension length	Dimension i.d.	Contents of one package
LiChrospher® RP-18 ADS	1.50385.0001	25 µm	25 mm	2 mm	1 piece
LiChrospher® RP-18 ADS	1.50386.0001	25 µm	25 mm	2 mm	3 pieces
LiChrospher® RP-18 ADS	1.50947.0001	25 µm	25 mm	4 mm	3 pieces
LiChrospher® RP-18 ADS cartridge set	1.50187.0001	25 µm	25 mm	4 mm	1 LiChroCART® 25-4 LiChrospher® RP-18 ADS 1 manu-CART® holder 25-4

These products are not intended for use as in-vitro diagnostics in terms of European Directive 98/79/EC. They are for research purposes only, for investigating in-vitro samples derived from the human body without any medical objective.

Ordering information – LiChrospher® ADS cartridge kit and accessories

Product	Ordering No.	Particle size	Dimension length	Dimension i.d.	Contents of one package
LiChrospher® ADS cartridge kit	1.50210.0001	25 µm	25 mm	4 mm	1 LiChroCART® 25-4 LiChrospher® RP-4 ADS 1 LiChroCART® 25-4 LiChrospher® RP-8 ADS 1 LiChroCART® 25-4 LiChrospher® RP-18 ADS 1 manu-CART® holder 25-4
LiChrospher® ADS In-line filter (replacement pack)	1.51192.0001	25 µm	-	-	5 pieces
In-line filter holder	1.51193.0001	25 µm	-	-	1 piece
Filter insert In-line	1.51194.0001	2 µm	-	-	10 pieces

These products are not intended for use as in-vitro diagnostics in terms of European Directive 98/79/EC. They are for research purposes only, for investigating in-vitro samples derive from the human body without any medical objective.

Ordering information – LiChrospher® ADS bulk sorbents

Product	Ordering No.	Particle size	Filling amount	Packaging
LiChrospher® RP-4 ADS	1.50349.0010	25 µm	10 g	Plastic bottle

These products are not intended for use as in-vitro diagnostics in terms of European Directive 98/79/EC. They are for research purposes only, for investigating in-vitro samples derived from the human body without any medical objective.

LiChrospher® ADS working principle

Prior to its first use the LiChrospher® ADS precolumn has to be conditioned as follows:

15 mL	2-propanol
15 mL	methanol
15 mL	water

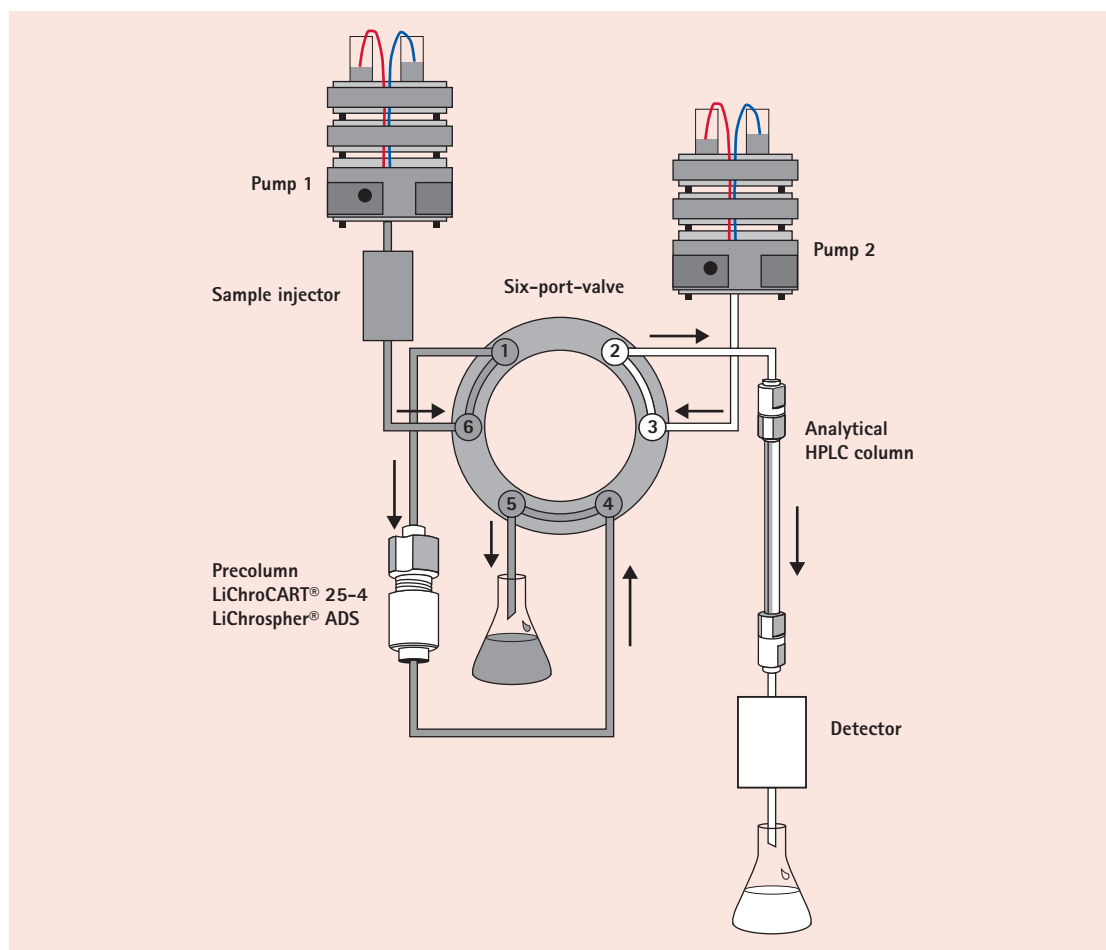

1. Sample injection and fractionation

The sample is injected directly onto the precolumn. In an ideal situation the precolumn packing only retains, i.e. extracts and enriches the analyte(s) while all other sample components (unwanted matrix) are discharged to waste with the eluent delivered by pump 1.

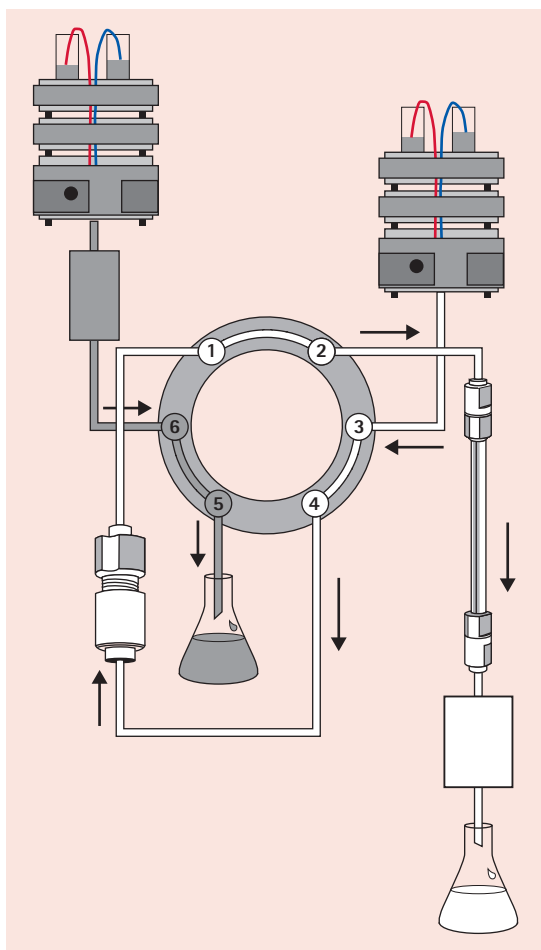

2. Transfer of the analytes

Transfer of the analytes to the analytical column. A conventional, manually or electrically driven six-port valve is used to couple the precolumn and an analytical column in series. An eluent delivered by pump 2 flushes the precolumn under reversal of the flow direction (back-flush peak compression). The stronger elution power of this eluent causes the analyte(s) to be desorbed from the precolumn and to be transferred on top of the analytical column.

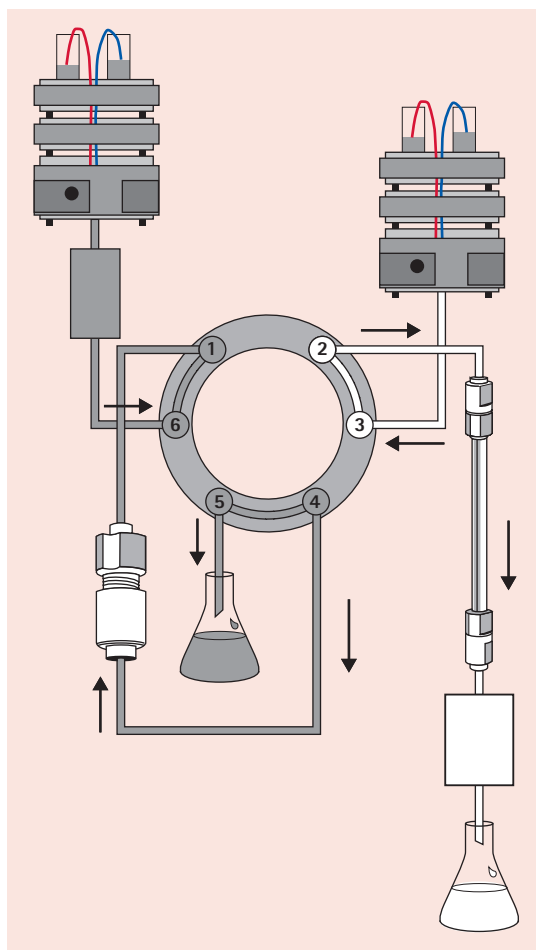

3. HPLC-Separation

After switching back into the original valve position the analytes are separated in a conventional manner. While separation and detection take place, the precolumn is re-equilibrated with the initial eluent to be ready for the next sample injection.

LiChrospher® ADS working principle

Choose the right column

The inner surface of the porous particles exclusively is covered with a hydrophobic dispersion phase (C4, C8, C18 alkyl chains). These adsorption centers are freely accessible for low molecular analytes. Owing to the classical reversed-phase chromatographic properties of LiChrospher® RP ADS these sorbents also can be used for ion-pair chromatography. This means that also charged compounds can be enriched and extracted by adding an appropriate ion-pair reagent (e.g. octanesulfonic acid) to the mobile phase.

Three types of LiChrospher® ADS precolumns are available showing different hydrophobicity, retention, and extraction properties for non-polar sample compounds

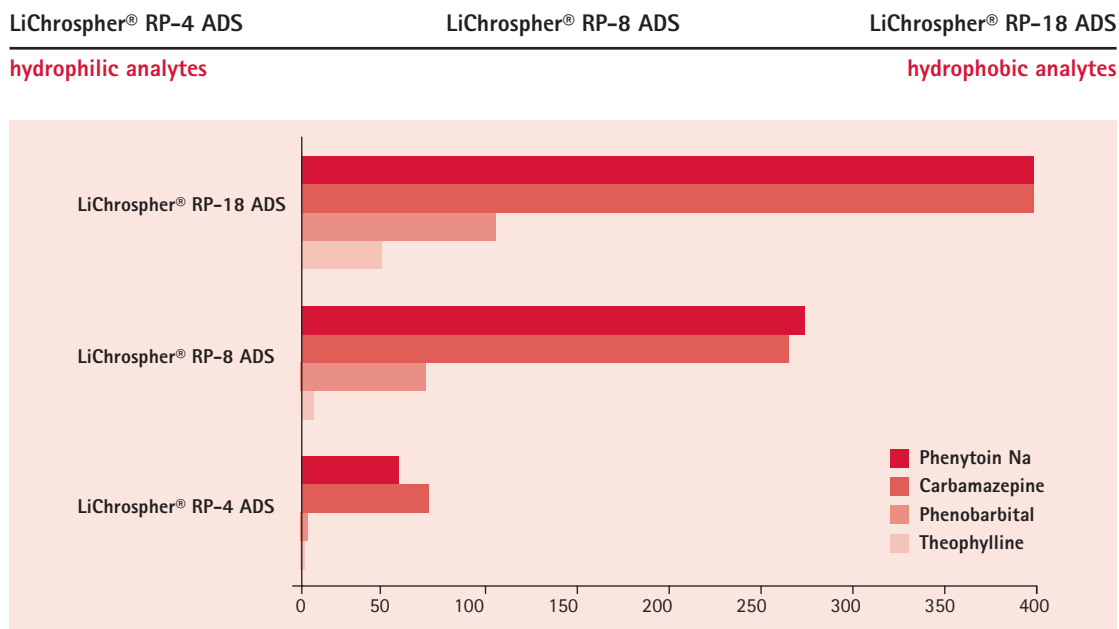

The selection of a LiChrospher® RP ADS precolumn with a low hydrophobicity has a further advantage with respect to the transfer step. E.g. if the sample cleanup is performed using a LiChrospher® RP-8 ADS precolumn and the analyte separation is achieved using a RP-18 column, then it is possible to lower the amount of organic modifier so that the transferred analyte fraction is enriched at the top of the analytical column.

LiChrospher® ADS instrumental set-up

The LiChroCART® 25-4 LiChrospher® ADS precolumn is connected via a 6-port switching valve to a conventional analytical column. The 6-port valve used for column switching has – in contrast to a sample injection valve – no direct sample or syringe inlet but an additional connection between connecting positions 4 – 5 or 5 – 6 subject to a 60 degree rotation. The valve can be operated manually, pneumatically or electrically.

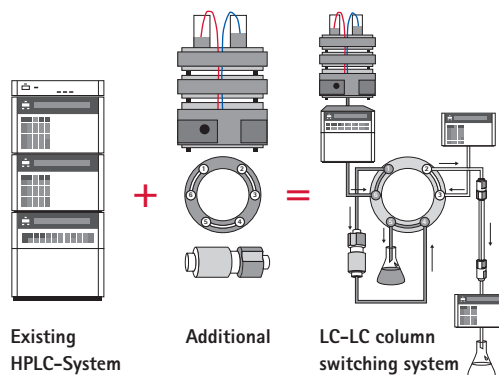

Applications of LiChrospher® ADS

Epirubicin in liver tumor

Precolumn	LiChrospher® RP-4 ADS, 20 x 4 mm i.d.
Analytical column	LiChrospher® 60 RP-select B, 250 x 4 mm i.d.
Flow rate	1 mL/min
Loading	95 % water, 5 % methanol 10 min
Transfer	30 % acetonitrile, 70 % water (0.1 % TEA, pH 2.0 with TCA) 5 min
Separation	30 % acetonitrile, 70 % water (0.1 % TEA, pH 2.0 with TCA) 10 min
Detection	Fluorescence Ex 445 nm, Em 560 nm
Sample	50 µl
1. Standard: 4'-Epirubicin-HCl	31 ng/mL
2. Supernatant of liver homogenate (protein)	207 mg/mL
3. Supernatant of liver tumor homogenate (protein) after tumor chemoembolization with Lipiodol/4'-Epirubicin-emulsion	1.34 mg/mL

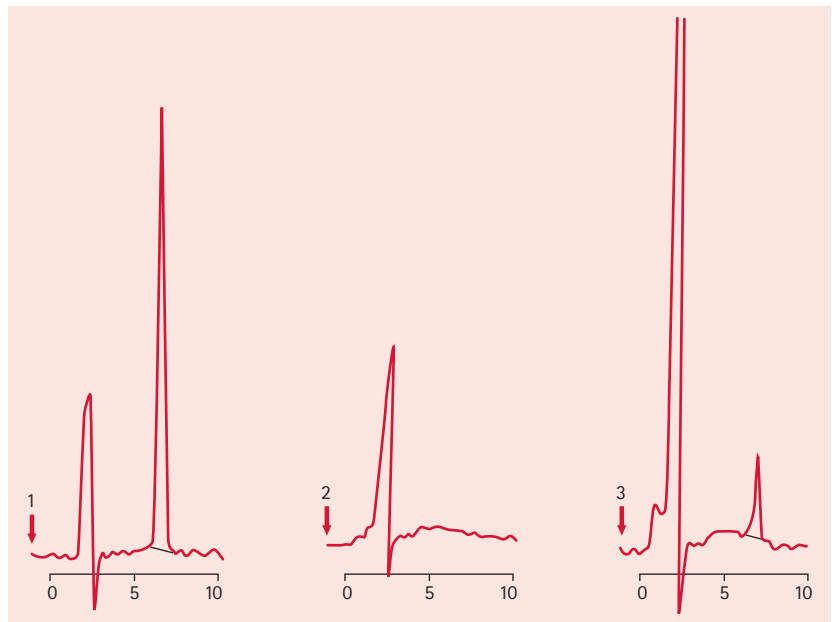

HPLC / Integrated BioDetection of biomarkers in biological samples

On-line coupling of Bioassays to HPLC

Precolumn	LiChrospher® RP-4 ADS, 10 x 2.1 mm i.d.
Analytical column	Chromasil C4, 100 x 2.1 mm i.d.
Mobile phase	Acetonitrile / 20 mM phosphate buffer pH 7.4 (30:70)
Flow rate	0.2 mL/min
Injection volume	500 µl
Label	Biodipy-LTE4
Antibody	Monoclonal anti-LTD4
Reagent flow	0.4 mL/min for both antibody and label
Detection	Fluorescence Ex 544 nm, Em 572 nm
Sample	Sulfidpeptide leukotrienes

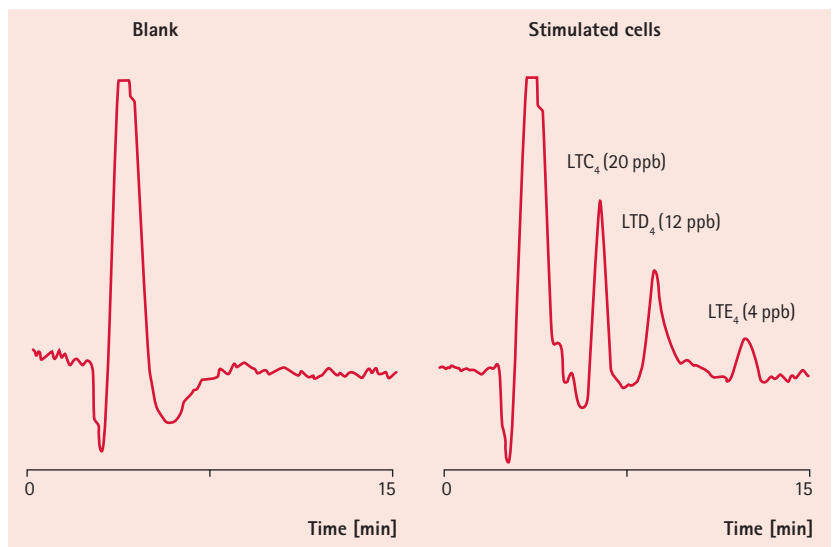

Ion exchangers and working principles

Ion exchangers

All natural and artificial substances which are capable of exchanging bounded ions for an equivalent amount of other ions from a surrounding solution are called ion exchangers.

In general, ion-exchangers consist of a cross-linked polymer matrix with a uniform distribution of fixed ionic sites throughout the resin structure. These must be balanced by a similar number of ions of the opposite charge, the counter ions, to maintain electrical neutrality. Cation exchangers therefore exchange and enrich only cations, anion exchangers only anions. In contrast adsorber resins have a non-ionic, but depending on the structure a somewhat polar character and don't adsorb stoichiometrically both: anions, cations, as well as uncharged compounds.

In essence, four types of ion exchanger can be distinguished:

- Gel ion exchangers
- Macroporous ion exchangers
- Fluid ion exchangers
- Adsorber resins

Ion exchangers have many different applications and therefore find many usages. The most commonly used application methods are the batch process and the column method.

Possible applications are:

- Trace enrichment by using chelating ion exchangers
- Determination of total salt content of solutions and water by H⁺ exchange
- Removal of interfering cations or anions
- Chromatographic separation
- Digestion of insoluble compounds
- Application as a catalyst

The two most commonly used working principles: batch and column method

Batch method

When the batch method is used the solution is shaken together with the according ion exchanger until the balance between the different ions is reached.

This method has many advantages when reactions have to be performed in closed systems where adding further ion exchange material is not possible due to technical reasons. This method also finds its usage whenever a catalytically effect is desired.

Column method

Within the technique as well as within the analytic often a different effect is desired. Usually a complete exchange of ions is needed at best possible utilization of reagent. For this purpose the column method is convenient. Within this method a wished treated solution runs through a column which is packed with the needed exchange material. Washing the packed exchange material within the column in between the steps is essential to remove a surplus of reagent solution within.

Working cycle of the exchangers for the column method:

- Exchange of ions
- Washing of the packing
- Regeneration or elution

The exchange of ions itself can be carried out differently, always according to the existing problem and the specifically needed application.

Application guide

Ion exchanger	Typical application
Strong acid cation exchanger	<ul style="list-style-type: none">• Water treatment• Separation of noble earths• Separation of amino acids• Used in the analysis and food industry
Weak acid cation exchanger	<ul style="list-style-type: none">• Purification and production of antibiotics, vitamins and alkaloids• Purification of enzymes
Strong basic anion exchanger	<ul style="list-style-type: none">• Water treatment• Acidimetric determination of aqueous salt solutions• Purification of complex isolation and determination of alkalis• Determination of pectin in fruit juices• Removal of interfering anions• Catalysis• Deionization of water• Purification of formaldehyde• Separation of amino acids
Weak basic anion exchanger	<ul style="list-style-type: none">• Separation from strong acids• Adsorption of basic dyes in an alkaline medium• Deionization of process solutions• Deacidification of non-aqueous solutions• Desalination of water
Mixed-bed ion exchangers	<ul style="list-style-type: none">• Demineralization of water
Adsorber resins	<ul style="list-style-type: none">• Separation of surface-active agents such as detergents, emulsifiers and dispersants• Removal of phenol• Isolation of vitamins and antibiotics

Please be aware that this is only a selection of typical application areas. In order to distinguish the ion exchanger needed for your specific application, please also visit our internet under www.merckmillipore.com/chromatography where you find more information.

Ion exchangers

The following pages show general information about ion exchangers available at Merck Millipore. If you are interested in additional information please visit www.merckmillipore.com/ionexchangers

Strongly acid cation exchangers

The bond strength of equivalent ions increases with decreasing diameter of the hydrated ion.

This leads to following selectivity series:

$\text{Li}^+ < \text{H}^+ < \text{Na}^+ < \text{NH}_4^+ < \text{K}^+ < \text{Rb}^+ < \text{Cs}^+ < \text{Ag}^+$

$\text{Be}^{2+} < \text{Mg}^{2+} < \text{Ca}^{2+} < \text{Sr}^{2+} < \text{Ba}^{2+}$

$\text{Hg}^{2+} < \text{Be}^{2+} < \text{Mn}^{2+} < \text{Mg}^{2+} = \text{Zn}^{2+} < \text{Co}^{2+} < \text{Cd}^{2+} < \text{Cu}^{2+} < \text{Ni}^{2+} < \text{Ca}^{2+} < \text{Pb}^{2+}$

$\text{Cr}^{3+} < \text{Ce}^{3+} < \text{La}^{3+}$

Specifications of strongly acid cation exchangers

Max. working temperature	120°C		
pH range	0-14		
Regenerant	HCl	H ₂ SO ₄	NaCl
Concentration in water [%]	5-10	2-4	8-10

Ordering information – Strongly acid cation exchangers

Product	Ordering No.	Form	Size	Exchange capacity [mval/mL]
Ionexchanger I	1.04765.0500	H ⁺	500 g	>1.7
Ionexchanger I	1.04765.5000	H ⁺	5 kg	>1.7
Amberlite® IR-120	1.15131.0500	H ⁺	500 mL	>1.7
Amberlite® IR-120	1.15131.5000	H ⁺	5 L	>1.7
Amberlite® IR-120	1.15966.0500	Na ⁺	500 mL	>1.9
Amberlyst® 15	1.15635.0500	H ⁺	500 mL	>1.75
Dowex® 50 WX 8	1.05221.0250	H ⁺	250 g	>1.7
Dowex® 50 WX 4	1.05238.0250	H ⁺	250 g	>1.1
Dowex® Monosphere 650C (H)	1.00586.0500	H ⁺	500 g	>2.0

Weak acid cation exchangers

The most important feature weak acid cation exchangers show is the very high selectivity in relation to H⁺ ions. Also they have a relatively high affinity for alkaline earth metal ions.

General: Na⁺ < Mg²⁺ < Ca²⁺ < H⁺
At pH level 7: Mg²⁺ < Ca²⁺ < Ni²⁺ < Co²⁺ < Cu²⁺

Specifications of weak acid cation exchangers

Max. working temperature	120°C	
pH range	4-14	
Regenerant	HCl	H ₂ SO ₄
Concentration in water [%]	2-3	0.5-1

Ordering information – Weak acid cation exchangers

Product	Ordering No.	Form	Size	Exchange capacity [mval/mL]
Ionexchanger IV	1.04835.0500	H ⁺	500 g	>3.2
Ionexchanger IV	1.04835.5000	H ⁺	5 kg	>3.2

Strong basic anion exchangers

An example for the binding strength of strong basic anion exchangers for Type I is as followed:

$F^- < OH^- < \text{Acetate} < H_2PO_4^- < HCO_3^- < Cl^- < NO_2^- < HSO_3^- < CN^- < Br^- < NO_3^- < HSO_4^- < I^- < SO_4^{2-}$
 Acetate <Formate <Tartrate <Citrate

For strong basic anion exchanger of Type II occurs a slight shift in accordance with the following selectivity series:

$F^- < OH^- < \text{Acetate} < IO_3^- < H_2PO_4^- < HCO_3^- < OH^- < BrO_3^- < Cl^- < CN^- = NO_2^- < Br^- = CF_3COO^- < CCl_3COO^- < SCN^- < HSO_4^- < I^- < ClO_4^-$

Specifications of strong basic anion exchangers

pH range	0-14	
Regenerant	NaCl	NaOH
Concentration in water [%]	8-10	2-4

Ordering information – Strong basic anion exchangers

Product	Ordering No.	Form	Size	Exchange capacity [mval/mL]
Ionexchanger III	1.04767.0500	OH ⁻	500 g	>0.9
Ionexchanger III	1.04767.5000	OH ⁻	5 kg	>0.9
Amberlite® IRA-402	1.12463.0500	Cl ⁻	500 mL	>0.9
Amberlite® IRA-410	1.15262.0500	Cl ⁻	500 mL	>1.35
Amberjet® 4200 CL	1.05245.0500	Cl ⁻	500 mL	>1.3
Dowex® 1-X8	1.05242.0250	Cl ⁻	250 mL	>1.2

Weak basic anion exchangers

The binding strength order of weak basic anion exchangers is as following:

$F^- < Cl^- < Br^- < I^- < \text{Acetate} < MoO_4^{2-} < PO_4^{3-} < AsO_4^{3-} < NO_3^- < \text{Tartrate} < \text{Citrate} < CrO_4^{2-} < SO_4^{2-} < OH^-$

Ordering information – Weak acid cation exchangers

Product	Ordering No.	Form	Size	Exchange capacity [mval/mL]
Amberlite® IRA-67	1.15959.0500	OH ⁻	500 g	>1.5
Ion exchanger II	1.04768.0500	OH ⁻	500 mL	>0.6
Ion exchanger II	1.04768.5000	OH ⁻	5 L	>0.6

Mixed bed exchangers

This mixed bed exchangers are mixtures of strong acid cation exchangers and strongly basic anion exchanger. They are mainly used in the demineralization of water, working within a pH value of 0-14.

Ordering information – Mixed bed exchangers

Product	Ordering No.	Form	Size	Anion exchange capacity [mval/mL]	Cation exchange capacity [mval/mL]
Ionexchanger V	1.04836.0500	H ⁺ / OH ⁻	500 g	>0.4	>0.5
Ionexchanger V	1.04836.5000	H ⁺ / OH ⁻	5 kg	>0.4	>0.5
Amberlite® MB-3	1.15127.0500	H ⁺ / OH ⁻	500 mL	>0.6	>0.5
Amberlite® MB-3	1.15127.5000	H ⁺ / OH ⁻	5 L	>0.6	>0.5
Amberlite® IRN-150	1.15965.0500	H ⁺ / OH ⁻	500 mL	>0.6	>0.7
Amberlite® MB-6113	1.15165.0500	H ⁺ / OH ⁻	500 g	>0.6	>0.5

Adsorber resin

The adsorbent resins are synthetic, mechanically stable, insoluble polystyrene divinyl-benzene polymerical, which are characterized by a macroreticular structure and a non-ionic character. In comparison to ion exchangers they show no shrinking or swelling.

Ordering information – Adsorber resin

Product	Ordering No.	Size
Amberlite® XAD-4	1.15256.0500	500 mL

Millex® Syringe Filters

Filter with confidence

Merck Millipore has a long history of enabling efficient sample preparation within the life science, environmental monitoring, clinical and industrial quality control markets. We constantly strive to advance sample preparation methods and help scientists meet the demands of lower detection limits and increased sample throughput.

An essential component of high quality separation and purification processes, Millex® Syringe Filters can be found in virtually every laboratory. The unsurpassed quality and consistency of results they provide has led to the creation of many sample preparation methods specifying Millex® filters. Global availability allows these methods to be easily transferred to any laboratory, anywhere in the world.



33 mm Millex® filters have polypropylene housings with a male Luer slip outlet.

13 mm Millex® filters have high density polyethylene or polypropylene housings and a male Luer slip outlet or MLS outlet with extension tube.

Millex[®] Syringe Filters

Sample preparation for chromatography

Applications

- High performance liquid chromatography (HPLC)
- Ultra high performance liquid chromatography (UHPLC)
- Ion chromatography (IC)
- Gas chromatography (GC)
- Dissolution testing
- General particulate removal

Membranes

- **LCR (hydrophilic PTFE):** Aqueous or mild organic solutions; low binding and extractables
- **Durapore[®] (PVDF):** Aqueous or mild organic solutions; low binding and extractables
- **Nylon:** Aqueous or organic solutions
- **Millipore Express[®] (PES):** Fast flow and low protein binding
- **Fluoropore[™] (hydrophobic PTFE):** Organic solvents

Housings

- High density polyethylene or polypropylene



Choosing the appropriate Millex[®] filter size

Process volume	Millex [®] filter diameter
<1 mL	4 mm
1 – 10 mL	13 mm
10 – 100 mL	25 mm
10 – 100 mL	33 mm

Low extractables

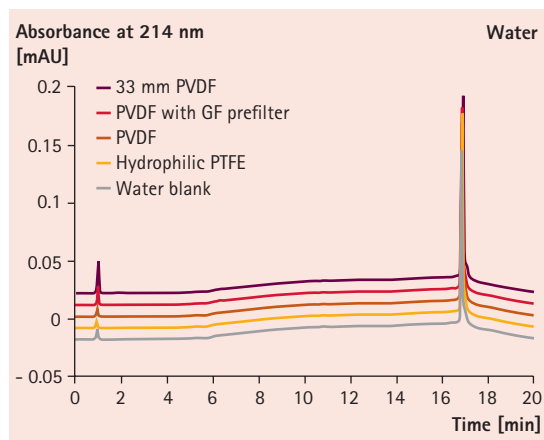

Low water extractables indicate that Millex[®] filters are ideal for dissolution studies and other aqueous-based sample prep protocols.

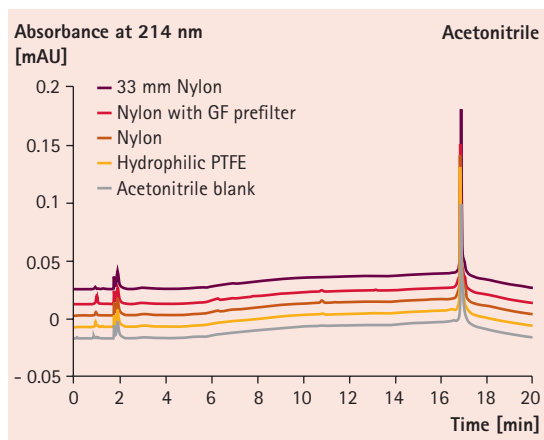

Low extractables are also observed with organic solvents.

► For further information please have a look at our website: www.merckmillipore.com/filtration

Millex® Syringe Filters | Sample preparation for chromatography

Ordering information – Millex® Syringe Filters, 4 mm diameter

Product	Ordering No.	Content / Packaging	Outlet connection	Pore size	Type	Process volume	Hold-up volume [after air purge]
Millex® LCR (Hydrophilic PTFE) Membrane	SLLGR04NL	100	Male stepped	0.20 µm	LG	1 mL	<10 µL
	SLLHR04NL	100	Male stepped	0.45 µm	LH	1 mL	<10 µL
	SLLHR04NK	1000					
Durapore® (PVDF) Membrane	SLGVR04NL	100	Male stepped	0.22 µm	GV	1 mL	<10 µL
	SLGVR04NK	1000					
	SLHVR04NL	100	Male stepped	0.45 µm	HV	1 mL	<10 µL
	SLHVR04NK	1000					
Fluoropore™ (Hydrophobic PTFE) Membrane	SLFGR04NL	100	Male stepped	0.20 µm	FG	1 mL	<10 µL
	SLFHR04NL	100	Male stepped	0.45 µm	FH	1 mL	<10 µL

Ordering information – Millex® Syringe Filters, 13 mm diameter

Product	Ordering No.	Content / Packaging	Outlet connection	Pore size	Type	Process volume	Hold-up volume [after air purge]
Millex® LCR (Hydrophilic PTFE) Membrane	SLLGH13NL	100	Male Luer slip	0.20 µm	LG	10 mL	<25 µL
	SLLGH13NK	1000					
	SLCR013NL	100	Male Luer slip	0.45 µm	LCR	10 mL	<25 µL
	SLCR013NK	1000					
	SLCRT13NL	100	Tube outlet				
Durapore® (PVDF) Membrane	SLGVX13NL	100	Male Luer slip	0.22 µm	GV	10 mL	<25 µL
	SLGVX13NK	1000					
	SLGVX13TL	100	Tube outlet				
	SLHVX13NL	100	Male Luer slip	0.45 µm	HV	10 mL	<25 µL
	SLHVX13NK	1000					
	SLHVX13TL	100	Tube outlet				
Nylon Membrane	SLGNX13NL	100	Male Luer slip	0.20 µm	GN	10 mL	<25 µL
	SLGNX13NK	1000					
	SLGNX13TL	100	Tube outlet				
	SLHNX13NL	100	Male Luer slip	0.45 µm	HN	10 mL	<25 µL
	SLHNX13NK	1000					
	SLHNX13TL	100	Tube outlet				
IC Millex® Filters (Hydrophilic PTFE) Membrane	SLLGC13NL	100	Male Luer slip	0.20 µm	IC Millex®-LG	10 mL	<10 µL
	SLLHC13NL	100	Male Luer slip	0.45 µm	IC Millex®-LH	10 mL	<10 µL
Fluoropore™ (Hydrophobic PTFE) Membrane	SLFGX13NL	100	Male Luer slip	0.20 µm	FG	10 mL	<25 µL
	SLFGX13NK	1000					
	SLFGX13TL	100	Tube outlet				
	SLFHX13NL	100	Male Luer slip	0.45 µm	FH	10 mL	<25 µL
	SLFHX13NK	1000					
	SLFHX13TL	100	Tube outlet				

Millex® Syringe Filters | Sample preparation for chromatography

Ordering information – Millex® Syringe Filters, 25 mm diameter

Product	Ordering No.	Content / Packaging	Outlet connection	Pore size	Type	Process volume	Hold-up volume [after air purge]
Millex® LCR (Hydrophilic PTFE) Membrane	SLLGH25NS	50	Male Luer slip	0.20 µm	LCR	100 mL	<100 µL
	SLLGH25NB	250					
	SLLGH25NK	1000					
	SLCR025NS	50	Male Luer slip	0.45 µm	LCR	100 mL	<100 µL
	SLCR025NB	250					
	SLCR025NK	1000					
IC Millex® Filters (Hydrophilic PTFE) Membrane	SLLGC25NS	50	Male Luer slip	0.20 µm	IC Millex®-LG	100 mL	<100 µL
	SLLHC25NS	50	Male Luer slip	0.45 µm	IC Millex®-LH	100 mL	<100 µL
Fluoropore™ (Hydrophobic PTFE) Membrane	SLFG025NS	50	Male Luer slip	0.20 µm	FG	100 mL	<100 µL
	SLFG025NB	250					
	SLFG025NK	1000					
	SLFH025NS	50	Male Luer slip	0.45 µm	FH	100 mL	<100 µL
	SLFH025NB	250					
	SLFH025NK	1000					
	SLLS025NS	50	Male Luer slip	5.0 µm	LS	100 mL	<100 µL

Ordering information – Millex® Syringe Filters, 33 mm diameter

Product	Ordering No.	Content / Packaging	Outlet connection	Pore size	Type	Process volume	Hold-up volume [after air purge]
Durapore® (PVDF) Membrane	SLGV033NS	50	Male Luer slip	0.22 µm	GV	100 µL	≤80 µL
	SLGV033NB	250					
	SLGV033NK	1000					
	SLHV033NS	50	Male Luer slip	0.45 µm	HV	100 µL	≤80 µL
	SLHV033NB	250					
	SLHV033NK	1000					
Nylon Membrane	SLGN033NS	50	Male Luer slip	0.20 µm	GN	100 mL	≤80 µL
	SLGN033NB	250					
	SLGN033NK	1000					
	SLHN033NS	50	Male Luer slip	0.45 µm	HN	100 µL	≤80 µL
	SLHN033NB	250					
	SLHN033NK	1000					
Millipore Express® (PES) Membrane	SLGP033NS	50	Male Luer slip	0.22 µm	GP	200 mL	≤80 µL
	SLGP033NB	250					
	SLGP033NK	1000					
	SLHP033NS	50	Male Luer slip	0.45 µm	HP	100 µL	≤80 µL
	SLHP033NB	250					
	SLHP033NK	1000					

Membrane Filters

Mobile phase preparation for HPLC/UHPLC

Filtration tools for preparing HPLC/UHPLC buffers and mobile phases

Membrane filtration removes contaminating particles from solvents and mobile phases, increasing column life, minimizing back-pressure, and preventing system failure. That's why most HPLC/UHPLC instrument manufacturers recommend filtration of mobile phases using either 0.45 or 0.20 μm filters.

Membranes that display the highest particle retention tend to be the most effective at minimizing back-pressure. Polypropylene membranes exhibit poor particle retention, and therefore filtering UHPLC mobile phases through polypropylene is the least effective for reducing back-pressure buildup. In contrast, filtering the mobile phase through PTFE membranes, which show excellent particle retention, enable the UHPLC system to run without significant back-pressure buildup.

Ordering information – Disc filters



Product	Ordering No.	Pore size	Filter diameter
Durapore® PVDF Membrane Filter	GVWP04700	0.2 μm	47 mm
Durapore® PVDF Membrane Filter	GVWP09050	0.2 μm	90 mm
Durapore® PVDF Membrane Filter	HVWP04700	0.45 μm	47 mm
Durapore® PVDF Membrane Filter	HVWP09050	0.45 μm	90 mm
LCR PTFE Membrane Filter	FHLC04700	0.45 μm	47 mm
Nylon Membrane Filter	GNWP04700	0.2 μm	47 mm
Nylon Membrane Filter	HNWP04700	0.45 μm	47 mm
Omnipore® PTFE Membrane Filter	JGWP04700	0.2 μm	47 mm
Omnipore® PTFE Membrane Filter	JGWP09025	0.2 μm	90 mm

Ordering information – Filter holders and pumps



Product	Ordering No.	Filter diameter
All glass filter holder with 250 mL funnel	XX1504700	47 mm
Glass filter holder with stainless steel screen, with 1 L funnel	XX1009020	90 mm
Filter forceps, blunt-tipped, sterilizable	XX6200006P	
Chemical Duty Vacuum Pump, 115 V	WP6111560	
Chemical Duty Vacuum Pump, 220 V	WP6122050	

Millex[®] Syringe Filters

Sample preparation for HPLC/UHPLC

Sample preparation prior to analysis helps to bring a sample to a format that is compatible with the analytical technique, reduces sample complexity, removes interfering impurities from matrix and thereby concentrates the analyte prior to analysis. A typical sample for HPLC/UHPLC needs to be particle-free and completely soluble in the solvent compatible with the chromatography system.

Reduce signal-to-noise ratios and maintain clean baselines by filtering samples with Millex[®] syringe filters, Millex Smplicity[®] Filters, or MultiScreen[®] Filter Plates, depending on your throughput needs. With their broad chemical compatibility, low holdup volumes, and consistent quality, Millex[®] filters are ideal for preparing samples for HPLC/UHPLC analysis.



Filtration through 0.2 μm hydrophilic PTFE Millex[®] filters prevents back-pressure buildup on a UHPLC system.

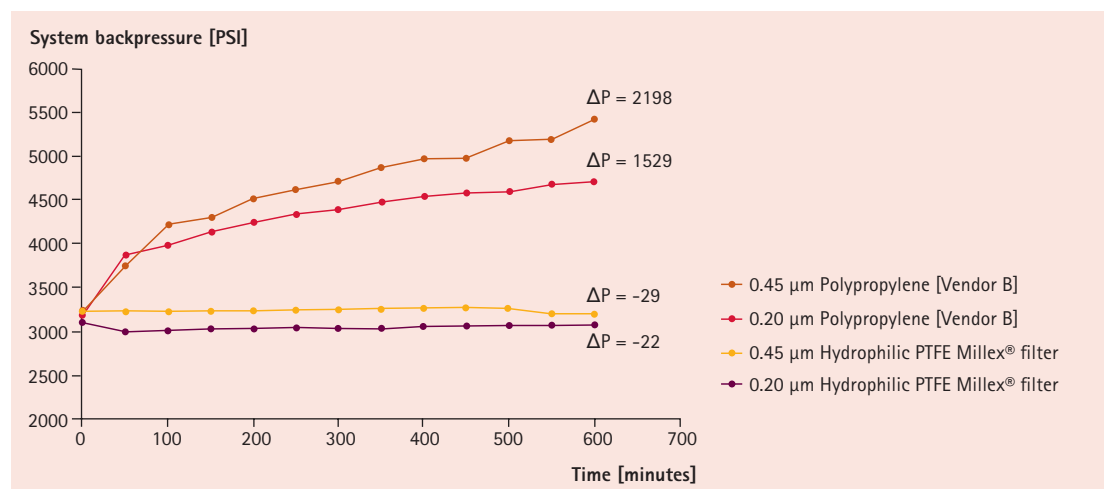

Water and acetonitrile were passed through polypropylene or PTFE syringe filters (as indicated in legend), then used 1:1 (v/v) to prepare the mobile phase for UHPLC. The system was run at 0.25 mL/min for 600 min with back-pressure recorded every 50 min. DP represents total change in back-pressure after 600 min.

► For further information please have a look at our website: www.merckmillipore.com/filtration

Merck Millipore filters for preparing HPLC/UHPLC samples

Reduce signal-to-noise ratios and maintain clean baselines by filtering samples with Millex® syringe filter units. With their broad chemical compatibility, low holdup volumes, and consistent quality, Millex® filters are ideal for preparing samples for HPLC/UHPLC analysis.



Low analyte binding Millex® filters

Millex® filters with PTFE membrane consistently provide greater than 90 % drug recovery in the first mL of filtrate, indicating low drug binding to PTFE.

Samples filtered through PTFE and nylon membrane syringe filters

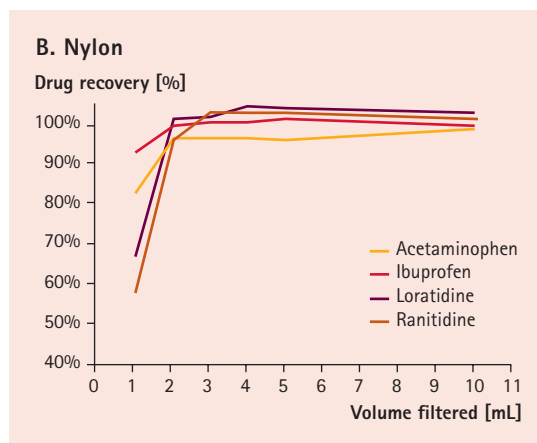
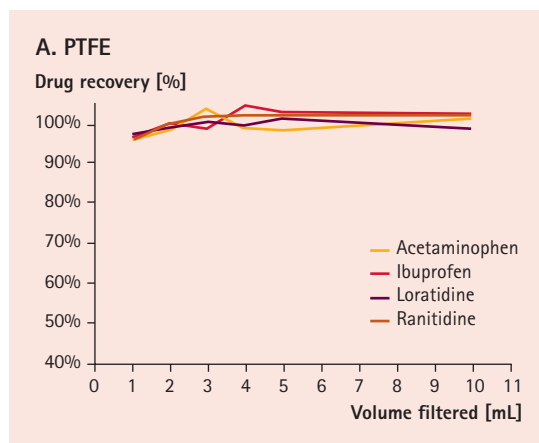

In drug dissolution tests, four different commercially available drug tablets (Acetaminophen, Ibuprofen, Loratidine, and Ranitidine) were dissolved in dissolution media. At the end of the dissolution period, samples were filtered through PTFE (A) and nylon (B) membrane syringe filters. Fractions were analyzed by UV spectroscopy.

Millex® filter units feature low extractables

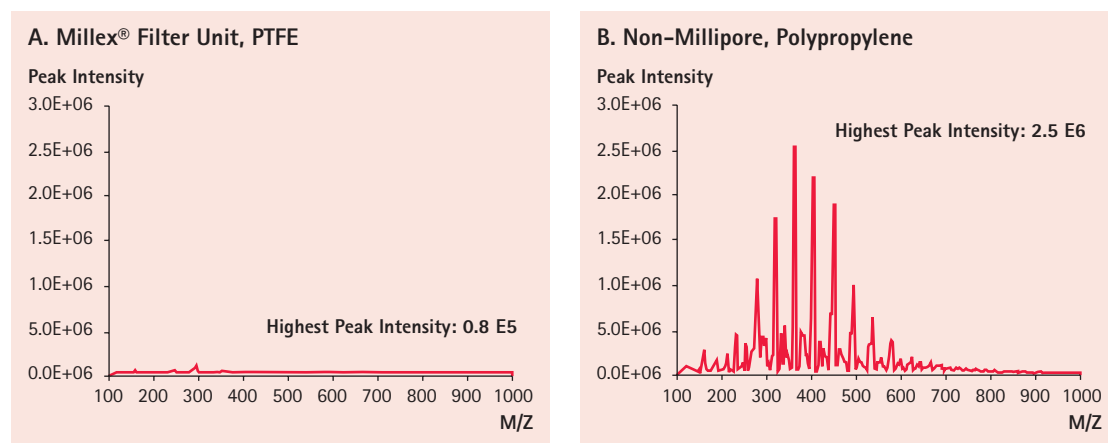

Mass spectrometry detects few extractable impurities from Millex® syringe filter (A) containing 0.45 µm pore hydrophilic PTFE membrane. In contrast, a syringe filter containing 0.45 µm pore polypropylene membrane (non-Merck Millipore, B) shows significant leaching of impurities.

Ordering information –

Non-sterile Millex® syringe filters with hydrophilic PTFE membrane

Lowest level of extractables and excellent solvent resistance

Product	Ordering No.	Pore size	Filter diameter	Content / Packaging *
Millex®-LG Syringe Filter	SLLGR04NL	0.2 µm	4 mm	100
Millex®-LG Syringe Filter	SLLGH13NK	0.2 µm	13 mm	1000
Millex®-LG Syringe Filter	SLLGH25NK	0.2 µm	25 mm	1000
Millex®-LH Syringe Filter	SLLHR04NL	0.45 µm	4 mm	100
Millex®-LCR Syringe Filter	SLCR013NK	0.45 µm	13 mm	1000
Millex®-LCR Syringe Filter	SLCR025NK	0.45 µm	25 mm	1000



* Additional pack sizes available

Ordering information – Non-sterile Millex® syringe filters with Durapore® membrane

Low protein binding

Product	Ordering No.	Pore size	Filter diameter	Content / Packaging *
Millex®-GV Syringe Filter	SLGVR04NL	0.2 µm	4 mm	100
Millex®-GV Syringe Filter	SLGVX13NK	0.2 µm	13 mm	1000
Millex®-GV Syringe Filter	SLGV033NK	0.2 µm	25 mm	1000
Millex®-HV Syringe Filter	SLHVR04NL	0.45 µm	4 mm	100
Millex®-HV Syringe Filter	SLHVX13NK	0.45 µm	13 mm	1000
Millex®-HV Syringe Filter	SLHV033NK	0.45 µm	25 mm	1000

* Additional pack sizes available

Millex[®] Syringe Filters

Automation-compatible filters

Automation-compatible filter benefits

- Engineered specifically for robotic systems, automation-compatible 25 mm Millex[®] Syringe Filters deliver trouble-free operation in automated filter changing stations
- Domed housing ensures reliable delivery of filters
- Pressure resistant housing resists bursting
- Luer-Lok[®] connection optimized for precise alignment and fit
- Available in either bulk or delivery tubes for use with automated filter changing system, including Caliper, Varian and Sotax workstations

Applications

- Dissolution testing
- HPLC sample preparation

Membranes

- **Glass Fiber:** Clarifying aqueous or organic solutions with high particulate levels
- **Millex[®] LCR (hydrophilic PTFE)*:** Clarifying aqueous or organic solutions
- **Durapore[®] (PVDF)*:** Clarifying aqueous and mild organic solutions; ultra-low protein binding
- **Nylon*:** Clarifying aqueous or organic solutions
- **Multi-layer prefilter configuration:** Clarification of high particulate and viscous solutions

* Also available with glass fiber prefilter for clarifying solutions with high particulate levels.

Housings

- Low-extractable, high-density polyethylene



Rigid domed housing design

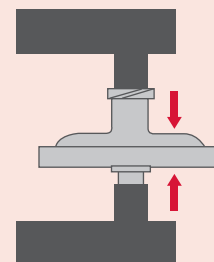

A rigid domed housing design helps prevent back-pressure, which can cause a workstation shut-down.

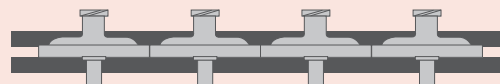
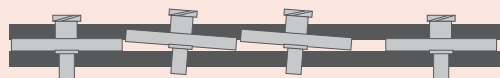

The domed housing of automation-compatible 25 mm Millex[®] Syringe Filters enables smooth, reliable delivery by eliminating shingling between filters in the transport rack.

Advantage:

Our **automation-compatible syringe filters** feature a rigid domed housing design that prevents back-pressure buildup and also prevents shingling between filters, inside automated workstations.

► For further information please have a look at our website: www.merckmillipore.com/filtration

Millex® Syringe Filters | Automation-compatible filter

Ordering information – Millex® Syringe Filters, 25 mm diameter | Automation-compatible filter

Product	Ordering No.	Content / Packaging	Pore size	Type	Process volume [max]
Glass Fiber Filter	SLPBDZ5NZ	200 (8 x 25)	1.0 µm	PB	100 mL
	SLPBDZ5NK	1000			
Millex® LCR (Hydrophilic PTFE) Membrane	SLLGDZ5NZ	200 (8 x 25)	0.20 µm	LG	100 mL
	SLLGDZ5NK	1000			
	SLCRDZ5NZ	200 (8 x 25)	0.45 µm	LCR	100 mL
	SLCRDZ5NK	1000			
Millex® LCR (Hydrophilic PTFE) Membrane with 1.0 µm Glass Fiber Prefilter	SLCRBZ5NZ	200 (8 x 25)	0.45 µm / 1.0 µm	LCR / PB	100 mL
	SLCRBZ5NK	1000			
Durapore® (PVDF) Membrane	SLHVDZ5NZ	200 (8 x 25)	0.45 µm	HV	100 mL
	SLHVDZ5NK	1000			
Durapore® (PVDF) Membrane with 1.0 µm Glass Fiber Prefilter	SLHVBZ5NZ	200 (8 x 25)	0.45 µm / 1.0 µm	HV / PB	100 mL
	SLHVBZ5NK	1000			
Nylon Membrane	SLHNDZ5NZ	200 (8 x 25)	0.45 µm	HN	100 mL
	SLHNDZ5NK	1000			
	SLGNDZ5NZ	200 (8 x 25)	0.20 µm	GN	100 mL
	SLGNDZ5NK	1000			
Nylon Membrane with 1.0 µm Glass Fiber Pre-filter	SLHNBZ5NZ	200 (8 x 25)	0.45 µm / 1.0 µm	HN / PB	100 mL
	SLHNBZ5NK	1000			

Standard (1000 packs) for individual use or 200 pack tubes for use on robotic systems.



Samplicity® Filtration System

Break free from routine sample filtration



The Samplicity® system is the ideal sample filtration tool for most chromatographers

The first vacuum-driven system with the designed in flexibility to filter 1 to 8 samples directly into standard HPLC sample vials, the Samplicity® Filtration System has the potential to break the sample prep bottleneck. Just attach a vacuum pump, load your samples, and flip the lever. Recover your particulate-free samples in seconds. Built upon decades of our membrane filtration expertise, the system's Millex Samplicity® Filters have a unique funnel shape for easy pipette loading and are provided in strips of four for faster loading. The filter strips are perforated for use with fewer samples.

Over 60 % of chromatographers process 10–100 samples a day

Most chromatographers (65 %, according to a recent Merck Millipore survey) process 10–100 samples a day into vials. For them, single-sample syringe filters and robotics and plate-based filtration systems are equally impractical. The Samplicity® Filtration System eliminates the tedium of syringe filtration and the space requirements and expense of robotics.

The Samplicity® Filtration System is ideal for medium throughput users in diverse fields, including:

- Drug dissolution testing – mandatory evaluation of the dissolution rate of solid dosage forms in the digestive tract
- Food safety – testing foods and beverages for unknown and known toxins, including glycol, melamine, and cyanobacteria
- Cosmetics – separation and detection of cosmetic ingredients and formulations
- Biofuels – analysis and extraction of lipids from algae and other biomass
- Pharmacokinetic/pharmacodynamic (PK/PD) testing – quantification of interactions of drugs with the body with respect to time

Low throughput

[1–10 samples/day]



Medium throughput

[10–100 samples/day]



High throughput

[>96 samples/day]



Filtration of viscous / particle-laden samples using the Samplicity® Filtration System

Samples of foods, beverages, pharmaceutical and other consumer products are frequently tested for safety and quality using chromatographic or other analytical separation techniques. Syringe filtration has proved to be an efficient means by which these samples can be clarified and made ready for downstream analyses. However, for hard-to-filter samples (samples containing particulate materials as well as samples that are viscous), syringe filtration is not easy and the particle load can easily clog the syringe filter. Food and beverage samples such as juices, honey, soups, salad dressing and ketchup can be very difficult to filter prior to analysis. Other hard-to-filter samples include many pharmaceutical suspensions, shampoos, conditioners, creams and other household products.

In contrast, the vacuum-driven Samplicity® filtration system filters even highly viscous samples in seconds, with minimal manual force. The Samplicity® filtration system also delivers high recovery because of the low hold-up volume of its Millex Samplicity® filters, making the system ideal for preparing samples for liquid chromatography.

A. Pharmaceutical samples

Filtration time [sec]

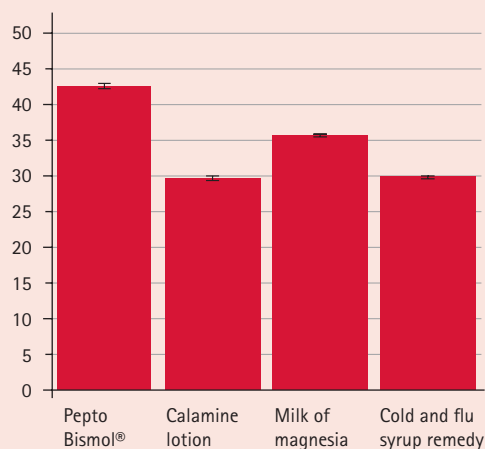

Pharmaceutical samples	Concentration	Viscosity (cP)
Pepto Bismol®	2 %	2.30
Calamine lotion	2 %	298.30
Milk of magnesia	100 %	10088.00
Cold and flu syrup remedy	5 %	2.20

B. Food/beverage samples

Filtration time [sec]

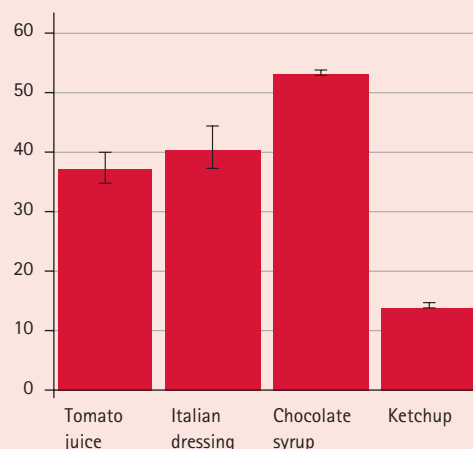

Food/beverage samples	Concentration	Viscosity (cP)
Tomato juice	100 %	18600.00
Italian dressing	25 %	12.07
Chocolate syrup	25 %	24.73
Ketchup	25 %	252.33

Efficient filtration of hard-to-filter samples. Hydrophilic PTFE Millex Samplicity® filters (0.45 µm) efficiently processed hard-to-filter pharmaceutical samples (A) and food/beverage samples (B) in seconds. Filtration times were the average of 4 replicates and error bars represent standard deviation.

Samplicity® Filtration System

Now you can truly do more with less.

Combine the Samplicity® Filtration System with state-of-the-art separation technologies.

The Samplicity® system provides higher yields with low hold-up volume, fast processing, and ease of use. And in addition to ergonomic benefits, the system creates less waste than syringe filtration and eliminates the need to segregate syringe waste. Together with Merck Millipore's mobile phases, solvent filtration systems, columns, and water purification systems, the Samplicity® Filtration System is the key to staying on the cutting edge of chromatographic separation.



Ordering information – Samplicity® systems and accessories

Product	Ordering No.	Content / Packaging	Color
Samplicity® Filtration System	SAMPSYSBL	1	bold blue
Samplicity® Filtration System Vial Trays	SAMVIALTR	2	
Samplicity® Filtration System Waste Trays	SAMWASTTR	5	
Samplicity® Filtration System Tube Set Assembly	SAMTUBING	1	
Samplicity® Filtration System Replacement Lid	SAMSYSLID	1	



Ordering information – Millex Samplicity® Filters

Product	Ordering No.	Content / Packaging	Pore size	Type
Millex Samplicity® Filters	SAMPLG001	96	0.20 µm	Hydrophilic PTFE
Millex Samplicity® Filters	SAMPLG004	384	0.20 µm	Hydrophilic PTFE
Millex Samplicity® Filters	SAMPLCR01	96	0.45 µm	Hydrophilic PTFE
Millex Samplicity® Filters	SAMPLCR04	384	0.45 µm	Hydrophilic PTFE
Millex Samplicity® Filters	SAMPHV001	96	0.45 µm	Hydrophilic PVDF
Millex Samplicity® Filters	SAMPHV004	384	0.45 µm	Hydrophilic PVDF



Ordering information – Required accessories for Samplicity® Filtration System

Product	Ordering No.	Volt [V]	Hertz [Hz]
Chemical Duty Pump	WP6111560	115 V	60 Hz
Chemical Duty Pump	WP6122050	220 V	50 Hz
Chemical Duty Pump	WP6110060	100 V	50–60 Hz





03

Thin Layer Chromatography



www.merckmillipore.com/thin-layer-chromatography

Even for those whose work is often out in the field to get samples, Merck Millipore's Thin Layer Chromatography (TLC) range is the ultimate analysis companion. Quick, convenient, and simple to handle, our TLC plates are suitable for a broad spectrum of applications, and ideal for screening purposes.

03

Contents

Thin Layer Chromatography	page 97
Classical silica TLC plates (TLC) For versatile and reliable routine analysis of a broad range of substances	page 98
Aluminium oxide TLC plates For basic and neutral compounds using different pH conditions	page 101
Kieselguhr and mixed layer plates For specific applications	page 102
High performance silica plates (HPTLC) For fast analysis of complex samples for manual or instrumental use	page 103
LiChrospher® HPTLC For fast analysis of complex samples for manual or instrumental use	page 106
RP-modified silica plates (TLC and HPTLC) Free choice of solvent system for special separations and as pilot method for HPLC	page 108
CN-, Diol- and NH ₂ -modified plates (TLC and HPTLC) For special separation problems	page 111
Cellulose TLC and HPTLC For analysis of polar substances	page 113
PEI (Polyethylenimine) Cellulose For specific separations by ion-exchange chromatography	page 115
Concentrating zone plates (TLC, HPTLC, PLC) Quick and easy sample application even of large volumes of diluted samples	page 116
ProteoChrom® HPTLC plates For peptide analysis	page 119
TLC silica gel 60G plates Highly robust plates with gypsum as binder, fully compliant with international pharmacopeia	page 122
Multiformat plates (TLC and HPTLC) Multiple sizes in one single glass plate	page 124
GLP plates (TLC and HPTLC) With individual laser coding for GLP applications	page 125
TLC and HPTLC MS-grade plates for mass spectrometry	page 126
Preparative layer plates (PLC) For enrichment of target analytes in mg quantities and sample clean-up	page 132
Bulk sorbents for preparation of TLC plates Standardized sorbents for reliable results	page 133
Accessories	page 135
Technical appendix	page 136

Thin Layer Chromatography

Fast separation of a broad range of substances

Thin Layer Chromatography (TLC) is a simple, fast and highly versatile separation tool for both qualitative and quantitative analyses. The field of application covers virtually all classes of substances including pesticides, steroids, alkaloids, lipids, nucleotides, glycosides, carbohydrates, fatty acids and many others.

Advantages of TLC:

- Economical separation method without the need for sophisticated instruments
- No cumbersome sample preparation step needed because plates are disposable
- Sample components are stored on the plate, allowing the analysis to be repeated several times
- Multiple samples (up to 72) can be run simultaneously under identical conditions
- Easy 2-dimensional separation by using two distinct mobile phases in different directions

Apart from the manual method of classical TLC, the technique can also be automated as in instrumental high-performance Thin Layer Chromatography (HPTLC). Furthermore, it can be easily extended to preparative scale for PLC.

Unique quality from the pioneer in Thin Layer Chromatography

As a pioneer in TLC, Merck Millipore introduced the first pre-coated plates on the market. And we continue to develop innovative products to meet the requirements of today's demanding applications.

Merck Millipore offers reliable TLC plates in a wide range of chemistries, sizes and backings to suit a variety of applications. They combine robustness with the highest surface homogeneity for unsurpassed separation. Our HPTLC plates provide even greater sensitivity and standardization. Merck Millipore quality is renowned and proven by countless TLC applications in chromatographic studies.

Classical silica TLC plates (TLC)

For versatile and reliable routine analysis of a broad range of substances

Silica gel is the most universal adsorbent used in TLC because it covers almost every type of separation by suitable choice of the mobile phase.

Merck Millipore classical silica TLC plates are based on proven Merck Millipore silica gel 60 with a pore diameter of 60 Å, a pore volume of 0.8 mL/g and a specific surface of 520 m²/g (BET). The unique polymeric binder results in a very adherent and hard surface that will not crack or blister and even allows writing with a pencil on the surface without risk of damaging the layer. The smooth and dense plate surface guarantees sharp bands for maximum separation efficiency with lowest background noise, e.g. when performing scanning densitometry.

Classical silica TLC plates have either a layer thickness of 250 µm (glass plates) or 200 µm (aluminium, plastic plates) and a mean particle size of 10 – 12 µm. They are available glass, aluminium or plastic backed in a broad range of different sizes to suit many application needs. The flexible backed aluminium or plastic plates can easily be cut with scissors to match individual separation requirements.



The flexible backed aluminium or plastic plates can easily cut with scissors to individual sizes

Specifications of classical TLC plates

Mean particle size	10 – 12 µm
Particle size distribution	5 – 20 µm
Layer thickness	250 µm, glass 200 µm, aluminium, plastic
Typical plate height	30 µm
Typical migration distance	10 – 15 cm
Typical separation time	20 – 200 min
Number of samples per plate	10

► **RP-modified silica plates (TLC and HPTLC)** Free choice of solvent system for special separations and as pilot method for HPLC
page 108

► **CN-, Diol- and NH₂-modified plates (TLC and HPTLC)** For special separation problems
page 111

► **Concentrating zone plates (TLC, HPTLC and PLC)** Quick and easy sample application even of large volumes of diluted samples
page 116

For UV detection of colorless substances, plates with two kinds of fluorescent indicator are available: green fluorescing F₂₅₄ (manganese activated zinc silicate) or blue fluorescing F_{254s} (magnesium tungstate). In addition, F_{254s} is highly stable in acidic solvent systems. Both indicators fluoresce in UV light at an excitation wavelength of 254 nm. Samples which absorb short-wave UV at 254 nm are detected due to fluorescence quenching.

Specially developed high-fluorescence LuxPlates® contain a higher content of fluorescent indicator for further improved identification of separate zones. In addition, the higher amount of binder results in an even more robust and abrasion-resistant surface.

Ordering information – TLC silica gel 60, glass backed

Product	Ordering No.	Format [cm]	Contents of one package
Silica gel 60 F ₂₅₄	1.05715.0001	20 x 20	25 plates
	1.05714.0001	5 x 20	100 plates
	1.05729.0001	10 x 20	50 plates
Silica gel 60	1.05721.0001	20 x 20	25 plates
	1.05626.0001	10 x 20	50 plates
	1.05724.0001	5 x 20	100 plates
	1.15326.0001	2.5 x 7.5	100 plates
Silica gel 60 F ₂₅₄	1.05808.0001	5 x 20	25 plates
	1.05719.0001	5 x 10	200 plates
	1.05789.0001	5 x 10	25 plates
	1.15327.0001	2.5 x 7.5	100 plates
	1.15341.0001	2.5 x 7.5	500 plates
Silica gel 60 WF _{254s}	1.16485.0001	20 x 20	25 plates
LuxPlate® silica gel 60 F ₂₅₄	1.05805.0001	20 x 20	25 plates
	1.05804.0001	10 x 20	50 plates
	1.05802.0001	5 x 10	25 plates
	1.05801.0001	2.5 x 7.5	100 plates

Layer thickness: 250 µm | W: Water resistant | F₂₅₄: Green fluorescent indicator | F_{254s}: Blue fluorescent indicator

Ordering information – TLC silica gel 60, aluminium backed

Product	Ordering No.	Format [cm]	Contents of one package
Silica gel 60	1.05553.0001	20 x 20	25 sheets
	1.16835.0001	5 x 10	50 sheets
Silica gel 60 W	1.16487.0001	20 x 20	25 sheets
Silica gel 60 F ₂₅₄	1.05554.0001	20 x 20	25 sheets
	1.05570.0001	10 x 20	25 sheets
	1.16834.0001	5 x 10	50 sheets
	1.05549.0001	5 x 7.5	20 sheets
	1.05562.0001	500 x 20	1 roll
Silica gel 60 WF _{254s}	1.16484.0001	20 x 20	25 sheets

Layer thickness: 200 µm | W: Water resistant | F₂₅₄: Green fluorescent indicator | F_{254s}: Blue fluorescent indicator

Classical silica TLC plates (TLC)

Ordering information – TLC silica gel 60, plastic backed

Product	Ordering No.	Format [cm]	Contents of one package
Silica gel 60	1.05748.0001	20 x 20	25 sheets
Silica gel 60 F ₂₅₄	1.05735.0001	20 x 20	25 sheets
	1.05750.0001	4 x 8	50 sheets
	1.05749.0001	500 x 20	1 roll

Layer thickness: 200 µm | F₂₅₄: Green fluorescent indicator

Applications of classical silica TLC

Unmodified silica gel covers more than 80 % of Thin Layer Chromatography applications for both adsorption- and partition Thin Layer Chromatography. It allows separation of a large range of different substances such as aflatoxins, alkaloids, anabolics, benzodiazepines, carbohydrates, fatty acids, glycosides, lipids, mycotoxins, nucleotides, peptides, pesticides, steroids, sulfonamides, surfactants, tetracyclines and many others making it suitable for:

- In-process control of drugs
- Purity checking of synthesis steps
- Identity testing of pharmaceutical compounds



Merck Millipore TLC plates deliver highly reproducible sharp bands over the whole plate as demonstrated by the parallel separation of a lipophilic dye mixture on a silica gel 60 classical TLC plate

Analysis of a sulfonamide mixture on TLC silica gel 60

Sample	1. Sulfadiazine 2. Sulfamerazine 3. Sulfisoxalozole 4. Sulfapyridine 5. Sulfanilamide (all 0.1 %)
Sample volume	0.75 µL
Mobile phase	Ethyl acetate / methanol / ammonia solution 25 % (60/20/2 (v/v/v))
Detection	UV 254 nm (TLC/HPTLC Scanner 2/CAMAG)

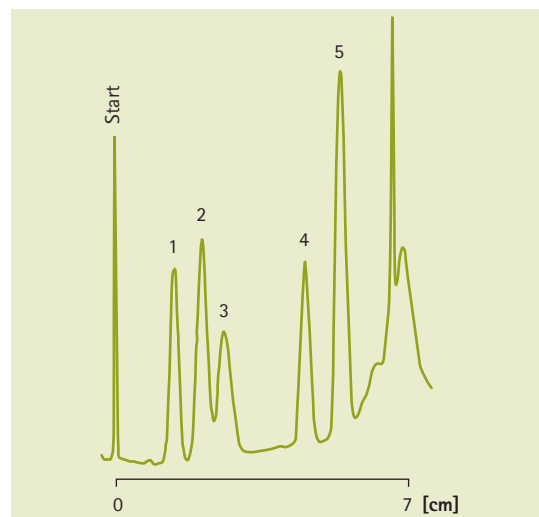

Analysis of a sulfonamide mixture on a TLC silica gel 60 reveals clear separation of five different antibacterial drugs.

Aluminium oxide TLC plates

For basic and neutral compounds using different pH conditions

Merck Millipore TLC aluminium oxide plates utilize neutral or basic aluminium oxide of 60 Å or 150 Å pore size with or without fluorescence indicator to suit different application needs. Aluminium oxide plates provide distinct separation features with regard to the pH range used: Under aqueous conditions basic compounds can be best separated on basic aluminium oxide plates, while neutral compounds are best separated on neutral plates.

Ordering information – TLC aluminium oxide 60

Product	Ordering No.	Format [cm]	Layer thickness	Backing	Contents of one package
Aluminium oxide 60 F ₂₅₄ basic	1.05713.0001	20 x 20	250 µm	glass	25 plates
Aluminium oxide 60 F ₂₅₄ basic	1.05731.0001	5 x 20	250 µm	glass	100 plates
Aluminium oxide 60 F ₂₅₄ neutral	1.05550.0001	20 x 20	200 µm	aluminium	25 sheets
Aluminium oxide 60 F ₂₅₄ neutral	1.05581.0001	20 x 20	200 µm	plastic	25 sheets

F₂₅₄: Green fluorescent indicator

Ordering information – TLC aluminium oxide 150

Product	Ordering No.	Format [cm]	Layer thickness	Backing	Contents of one package
Aluminium oxide 150 F ₂₅₄ neutral	1.05551.0001	20 x 20	200 µm	aluminium	25 sheets

F₂₅₄: Green fluorescent indicator



Kieselguhr and mixed layer plates

For specific applications

Kieselguhr is a natural diatomaceous earth that can be used for the separation of polar or moderately polar substances. Merck Millipore's mixed layer plates utilize a combination of classical silica gel 60 and kieselguhr to provide good separation properties for certain special applications such as separation of inorganic ions, herbicides and some steroids.

Ordering information – TLC plates, kieselguhr, silica gel/kieselguhr

Product	Ordering No.	Format [cm]	Layer thickness	Contents of one package
TLC glass plates Kieselguhr F ₂₅₄	1.05738.0001	20 x 20	0.2 mm	25 plates
TLC aluminium plates Kieselguhr F ₂₅₄	1.05568.0001	20 x 20	0.2 mm	25 sheets
TLC aluminium plates silica gel 60/Kieselguhr F ₂₅₄	1.05567.0001	20 x 20	0.2 mm	25 sheets

F₂₅₄: Green fluorescent indicator



High performance silica plates (HPTLC)

For fast analysis of complex samples for manual or instrumental use

Merck Millipore HPTLC silica plates offer higher speed and higher sensitivity than classical TLC and are therefore optimally suited for sophisticated separations.

Using instrumental equipment HPTLC plates makes for modern, quantitative Thin Layer Chromatography. HPTLC plates utilize an optimized silica 60 sorbent with a particle size of only 5-6 μm . The smaller particles give a smoother surface and a higher separation power than conventional TLC plates. Band diffusion is reduced, giving rise to very compact sample bands or zones. These features and the thinner layer (<200 μm) ultimately result in highly increased sensitivity and faster analysis. HPTLC silica plates are available either glass or aluminium backed in a variety of different formats to suit various separation needs. Just as in the classical range, two kinds of fluorescent indicators are used: the green fluorescing F_{254} and the blue fluorescing acid-stable F_{254s} . Both indicators fluoresce in UV light at an excitation wavelength of 254 nm.

Specifications of HPTLC versus classical TLC plates

	HPTLC	TLC
Mean particle size	5-6 μm	10 – 12 μm
Particle size distribution	4 – 8 μm	5 – 20 μm
Layer thickness	200 μm (100 μm)	250 μm (200 μm)
Typical plate height	12 μm	30 μm
Typical migration distance	3 – 6 cm	10 – 15 cm
Typical separation time	3 – 20 min	20 – 200 min
Number of samples per plate	<36 (72)	<10
Sample volume	0.1 – 0.5 μl	1 – 5 μl
Detection limits absorption	100 – 500 μg	1 – 5 ng
Detection limits fluorescence	5 – 10 μg	50 – 100 μg

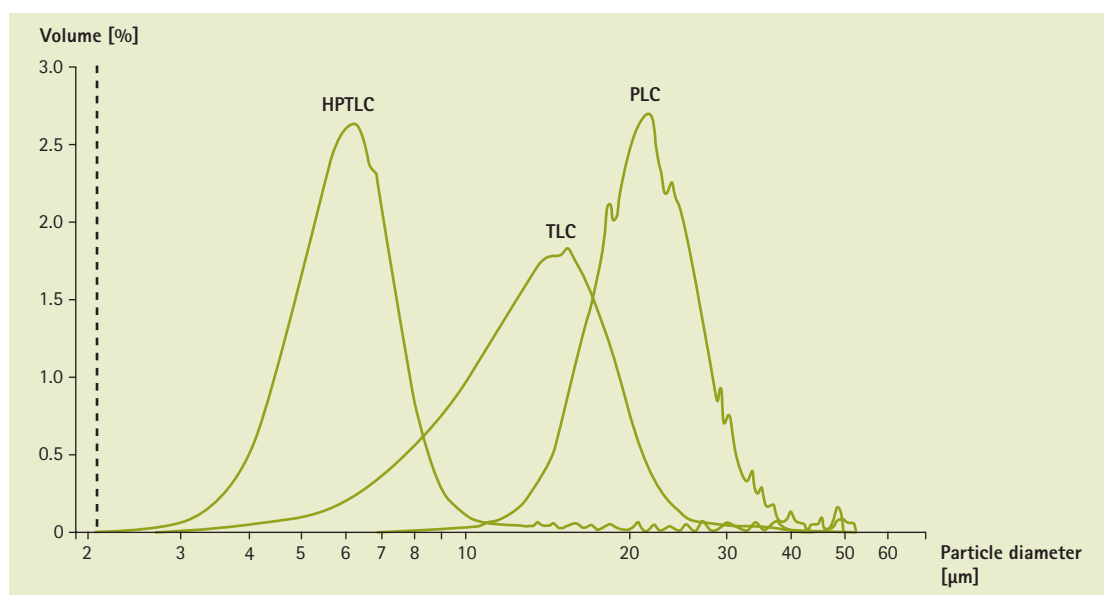

Comparison of the particle size distribution of TLC, HPTLC and PLC

- ▶ **RP-modified silica plates (TLC and HPTLC)** Separations and as pilot method for HPLC **page 108**
- ▶ **CN-, Diol- and NH₂-modified plates (TLC and HPTLC)** For special separation problems **page 111**
- ▶ **Concentrating zone plates (TLC, HPTLC, PLC)** Quick and easy sample application even of large volumes of diluted samples **page 116**
- ▶ **ProteoChrom® HPTLC plates** For peptide analysis **page 119**

High-performance silica plates (HPTLC)

HPTLC plates AMD with an extra thin layer of only 100 µm have been specifically developed for even more demanding applications such as automated multiple development (AMD). It combines the repeated development of the plate in the same direction and reproducible gradient elution. AMD development provides extremely narrow bands, allowing the complete resolution of up to 40 components over a distance of 60 mm.

HPTLC Premium Purity plates are designed for high performance, completely contamination-free separations especially in demanding pharmacopeial applications.

- Highly pure, exhibiting minimal background even with medium-polar solvent systems
- Identical separation performance to the related HPTLC plate product
- Especially suited for pharmacopeial applications

HPTLC Premium Purity plates are based on the HPTLC Silica gel 60 F₂₅₄ plate but in addition are carefully wrapped in dedicated plastic coated aluminium foil. The special packing prevents any deposition of plasticizers such as phthalates from the wrapping material that could appear as unknown extra zones when using medium-polar solvent systems such as toluene / ethyl acetate (95/5) and which can be stained by derivatization reagents.

Ordering information – HPTLC silica gel 60, glass backed

Product	Ordering No.	Format [cm]	Contents of one package
HPTLC silica gel 60	1.05641.0001	20 x 10	50 plates
	1.05631.0001	10 x 10	25 plates
	1.05633.0001	10 x 10	100 plates
HPTLC silica gel 60 F ₂₅₄	1.05642.0001	20 x 10	50 plates
	1.05628.0001	10 x 10	25 plates
	1.05629.0001	10 x 10	100 plates
	1.05616.0001	5 x 10	25 plates
HPTLC silica gel 60 F _{254s}	1.15696.0001	20 x 10	25 plates
HPTLC silica gel 60 WR F _{254s}	1.15552.0001	20 x 10	25 plates
HPTLC silica gel 60 AMD extra thin layer *	1.11764.0001	20 x 10	25 plates
HPTLC silica gel 60 AMD WR F _{254s} extra thin layer *	1.12363.0001	20 x 10	25 plates
HPTLC silica gel 60 / Premium Purity Plate	1.05648.0001	20 x 10	50 plates
HPTLC silica gel 60 Prescored	1.05644.0001	5 x 5	100 plates

Layer thickness: 200 µm / * 100 µm | W: Water resistant | F₂₅₄: Green fluorescent indicator | F_{254s}: Blue fluorescent indicator

Ordering information – HPTLC silica gel 60, aluminium backed

Product	Ordering No.	Format [cm]	Contents of one package
HPTLC silica gel 60	1.05547.0001	20 x 20	25 sheets
HPTLC silica gel 60 F ₂₅₄	1.05548.0001	20 x 20	25 sheets
	1.05556.0001	5 x 7.5	20 sheets

Layer thickness: 200 µm | F₂₅₄: Green fluorescent indicator

Application of high performance silica plates (HPTLC)

HPTLC plates are ideal for highly demanding, quantitative analysis such as:

- Identity testing in analysis of herbal medicines & medicinal plants
- Highly sophisticated, quantitative separations such as quality control of drugs using instrumental equipment
- Quality or purity testing of complex samples in pharmaceutical QC
- Trace analysis in food

A. Classical TLC silica gel 60 plate

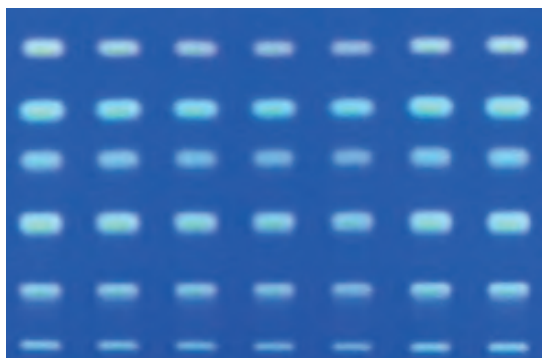

B. HPTLC silica gel 60 plate



Comparison of the separation of dansyl amino acids under identical conditions. The comparison clearly demonstrates that the HPTLC plate delivers sharper zones with shorter migration distances and faster analysis times. In addition the HPTLC plate allows the separation of twice the number of samples simultaneously.

Comparison of classical TLC versus HPTLC plates

	(A) TLC	(B) HPTLC
Sample	1. N-alpha-dansyl-L-asparagine 2. alpha-dansyl-L-arginine 3. Dansyl-L-cysteic acid 4. N-Dansyl-L-serine 5. Dansyl-glycine 6. N-N-Didansyl-L-tyrosine	
Mobile phase	Ethyl acetate/methanol/propionic acid (22/10/3)	
Detection	UV 366	
Sample volume	4 µm	0.3 µm
Migration distance	10 cm	5 cm
Analysis time	42 min	13 min 45 sec

In order to fully exploit the potential of HPTLC plates to deliver reliable and reproducible quantitation, appropriate instrumentation for sample application and data evaluation is essential. Please refer to the comprehensive CAMAG product range under www.camag.com.

LiChrospher® HPTLC

For fast analysis of complex samples for manual or instrumental use

Unique HPTLC LiChrospher® plates are the only Thin Layer Chromatography products based on spherical silica particles. They offer the ultimate in Thin Layer Chromatography performance and speed enabling high throughput analysis of complex samples.

- Further 20 % reduced running times
- Highly compact zones
- Lower detection limits

HPTLC LiChrospher® plates are based on LiChrospher®, Merck Millipore's proven spherical shaped silica 60 with a small particle size of 7 µm and narrow particle size distribution as normally used in HPLC. LiChrospher® has a broad selectivity, very similar to the respective HPTLC plate; however plate height, separation numbers and velocity constants are even further improved.

A. LiChrospher® HPTLC plate

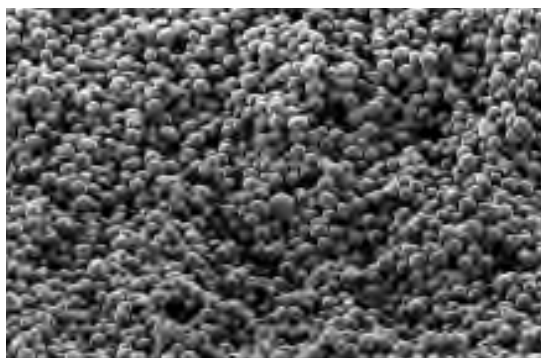

B. HPTLC silica plate



Scanning electron microscope pictures of the cross section of (A) a LiChrospher® HPTLC plate and (B) a HPTLC silica plate

Analysis times on a HPTLC LiChrospher® compared with a normal HPTLC plate

Eluent	Migration distance	LiChrospher® silica gel 60 F _{254s}	HPTLC silica gel 60 F ₂₅₄
Toluene	4 cm	4 min	5 min, 45 sec
Ethyl acetate / toluene (95-5)	5 cm	6 min	7 min, 50 sec
Methyl ethyl ketone / 1-propanol / water / acetic acid (40+40+20+5)	5 cm	20 min	26 min, 30 sec
n-Hexane / toluene / acetone (70+20+10)	7 cm	13 min	19 min

F₂₅₄: Green fluorescent indicator | F_{254s}: Blue fluorescent indicator

Ordering information – HPTLC LiChrospher® silica gel 60

Product	Ordering No.	Format [cm]	Backing	Contents of one package
HPTLC LiChrospher® silica gel 60 F _{254s}	1.15445.0001	20 x 10	glass	25 plates
HPTLC LiChrospher® silica gel 60 F _{254s}	1.05586.0001	20 x 20	aluminium	25 sheets
HPTLC LiChrospher® silica gel 60 AMD WR F _{254s} extra thin *	1.05647.0001	20 x 10	glass	25 plates

Layer thickness: 200 µm / * 100 µm | F_{254s}: Blue fluorescent indicator

Ordering information – HPTLC LiChrospher® RP-modified silica gel 60

Product	Ordering No.	Format [cm]	Backing	Contents of one package
HPTLC LiChrospher® silica gel 60 RP-18 WF _{254s}	1.05646.0001	20 x 10	glass	25 plates

Layer thickness: 200 µm | F_{254s}: Green fluorescent indicator

Applications of LiChrospher® HPTLC

LiChrospher® HPTLC plates are suitable for a broad range of applications but especially for the analysis of highly complex low concentration samples, e.g. **analysis of pesticides mixtures** or **assaying of pharmaceutical compounds**.

A. HPTLC LiChrospher® Si 60 plate

B. Conventional HPTLC Si 60 plate

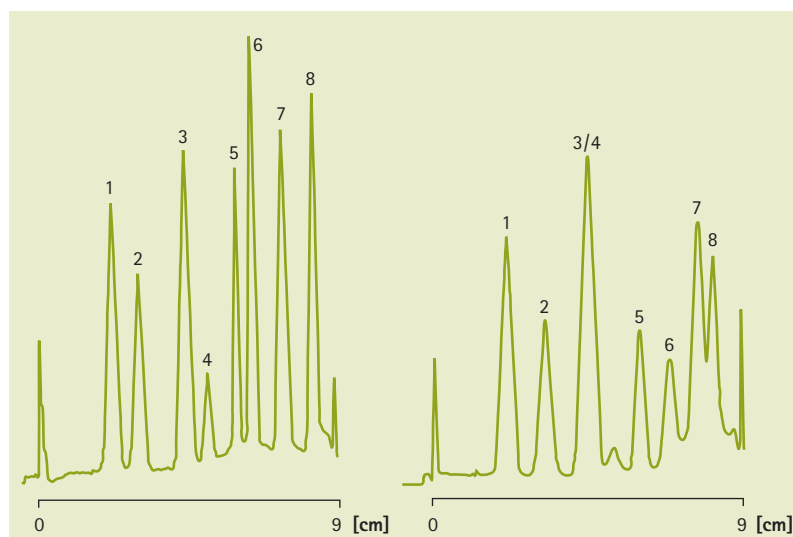

Pesticide separation

Sample	1. Hexazinone 2. Metoxuron 3. Monuron 4. Aldicarb 5. Azinphos-methyl 6. Prometryn 7. Pyridate 8. Trifluralin
Sample volume	50 mL
Mobile phase	Petroleum benzene 40-60°C / acetone 70/80
Detection	UV 254 nm

Pesticide separation on (A) HPTLC LiChrospher® and on a conventional (B) HPTLC plate demonstrating that using LiChrospher® plates allows the separation of more substances.

RP-modified silica plates (TLC and HPTLC)

Free choice of solvent system for special separations & HPLC pilot method

RP-modified silica layers are well suited for many separation problems that cannot be sufficiently solved by unmodified silica.

- Separation of extremely non-polar and highly polar substances using aqueous solvent systems
- Analysis of certain polar substances amenable to ion-pair chromatography, while neutral substances remain constant
- Less dependence on atmospheric humidity

In contrast to unmodified silica, RP phases do not exhibit catalytic activity and are therefore the plates of choice for unstable substances that might tend towards oxidative degradation. Furthermore, RP-modified silica plates provide ready correlation with HPLC columns and allow TLC to be used for method development and as a pilot method for HPLC.

Merck Millipore RP plates RP-2, RP-8 and RP-18 are based on silica gel 60 modified with aliphatic hydrocarbons of increasing hydrocarbon chain length resulting in increased hydrophobicity.

The hydrocarbon chain length in combination with the degree of modification strongly affects retention: Retention of the sample and migration times increases with the higher degree of modification and with growing hydrocarbon chain in the order RP-2, RP-8, RP-18 using the same solvent composition, while RF values decrease. Additionally, with rising water content in the solvent system, retention will increase.

The RP-2 sorbent exhibits higher polarity and high affinity with aqueous solutions tolerating up to 80 % water while the longer carbon chains RP-8 and R-18 can be run with up to 60 % and 40 % water, respectively, in the solvent system.

The special **HPTLC RP-18 W** with a defined lower degree of surface modification can be wetted and developed even with pure water.

The **RP-18 silica plates with concentrating zone** are especially suited for the high-resolution separation of polycyclic aromatic hydrocarbons (PAH).

Ordering information – TLC RP-modified silica gel 60, glass backed

Product	Ordering No.	Format [cm]	Contents of one package
Silica gel 60 RP-2 (silanized)	1.05746.0001	20 x 20	25 plates
Silica gel 60 RP-2 F ₂₅₄ (silanized)	1.05747.0001	20 x 20	25 plates
Silica gel 60 RP-8 F _{254s}	1.15388.0001	20 x 20	25 plates
	1.15424.0001	10 x 20	50 plates
	1.15684.0001	5 x 10	25 plates
Silica gel 60 RP-18 F _{254s}	1.15389.0001	20 x 20	25 plates
	1.15423.0001	10 x 20	50 plates
	1.15683.0001	5 x 20	50 plates
	1.15685.0001	5 x 10	25 plates

F₂₅₄: Green fluorescent indicator | F_{254s}: Blue fluorescent indicator

Ordering information – TLC RP-modified silica gel 60, aluminium backed

Product	Ordering No.	Format [cm]	Contents of one package
Silica gel 60 RP-18 F _{254s}	1.05559.0001	20 x 20	20 sheets
	1.05560.0001	5 x 7.5	20 sheets

F_{254s}: Blue fluorescent indicator

► **Classical silica TLC plates (TLC)** For versatile and reliable routine analysis of a broad range of substances
page 98

► **High performance silica plates (HPTLC)** For fast analysis of complex samples for manual or instrumental use
page 103

► **Concentrating zone plates (TLC, HPTLC, PLC)** Quick and easy sample application even of large volumes of diluted samples
page 116

Ordering information – HPTLC RP-modified silica gel 60, glass backed

Product	Ordering No.	Format [cm]	Contents of one package
HPTLC silica gel 60 RP-2 F _{254s}	1.13726.0001	10 x 10	25 plates
HPTLC silica gel 60 RP-8 F _{254s}	1.13725.0001	10 x 10	25 plates
HPTLC silica gel 60 RP-18	1.05914.0001	20 x 10	25 plates
HPTLC silica gel 60 RP-18 W	1.14296.0001	20 x 10	25 plates
HPTLC silica gel 60 RP-18 F _{254s}	1.13724.0001	10 x 10	25 plates
HPTLC silica gel 60 RP-18 F ₂₅₄	1.16225.0001	10 x 20	50 plates
HPTLC silica gel 60 RP-18 W	1.13124.0001	10 x 10	25 plates

F₂₅₄: Green fluorescent indicator | F_{254s}: Blue fluorescent indicator | Layer thickness: 200 µm | W: Fully wettable with water (can be used even with 100 % water in solvent system)

Separation of gallic acid and esters on HPTLC silica RP-18 WF₂₅₄

Sample	1. Dodecyl gallate 2. Butyl gallate 3. Ethyl gallate 4. Methyl gallate 5. Gallic acid
Sample volume	200 nl
Mobile phase	1 N acetic acid / methanol (70+30)
Migration distance	5 cm
Detection	UV 265 nm (TLC/HPTLC Scanner, Camag)



RP-modified silica plates are especially suited for the analysis of basic or acids substances as demonstrated by the good separation of gallic acid and its esters on HPTLC silica RP-18 WF₂₅₄.

RP-modified silica plates (TLC and HPTLC)

Application of RP-modified silica plates

RP-plates significantly broaden TLC applications and can be used for separation of amides, antibiotics, fatty acids:

A. HPTLC silica gel 60 RP-2

B. HPTLC silica gel 60 RP-8

C. HPTLC silica gel 60 RP-18

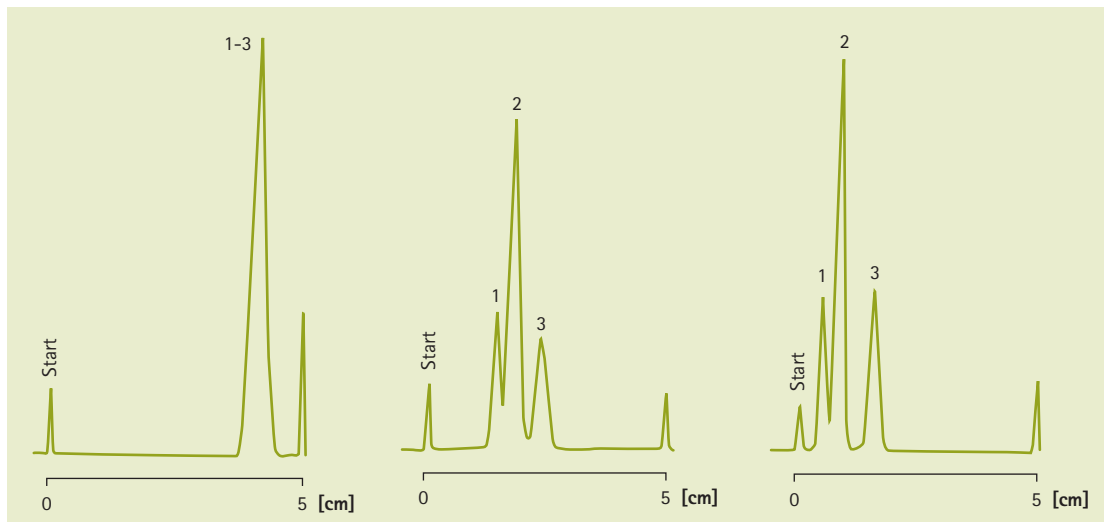

Influence of the hydrocarbon chain length on retention: Retention increases with growing hydrocarbon chain.

Comparison of RP-modified silica plates

Sample	1. Indeno-(1,2,3-c,d)pyrene	0.05 %
	2. 3,4-Benzfluoranthene	0.05 %
	3. Fluoranthene	0.05 %
Sample volume	100 nl	
Mobile phase	Acetonitrile – water (90+10)	
Migration distance	5 cm	
Detection	UV 366 nm (TLC/HPTLC Scanner, Camag)	
Chamber	Normal chamber without saturation	

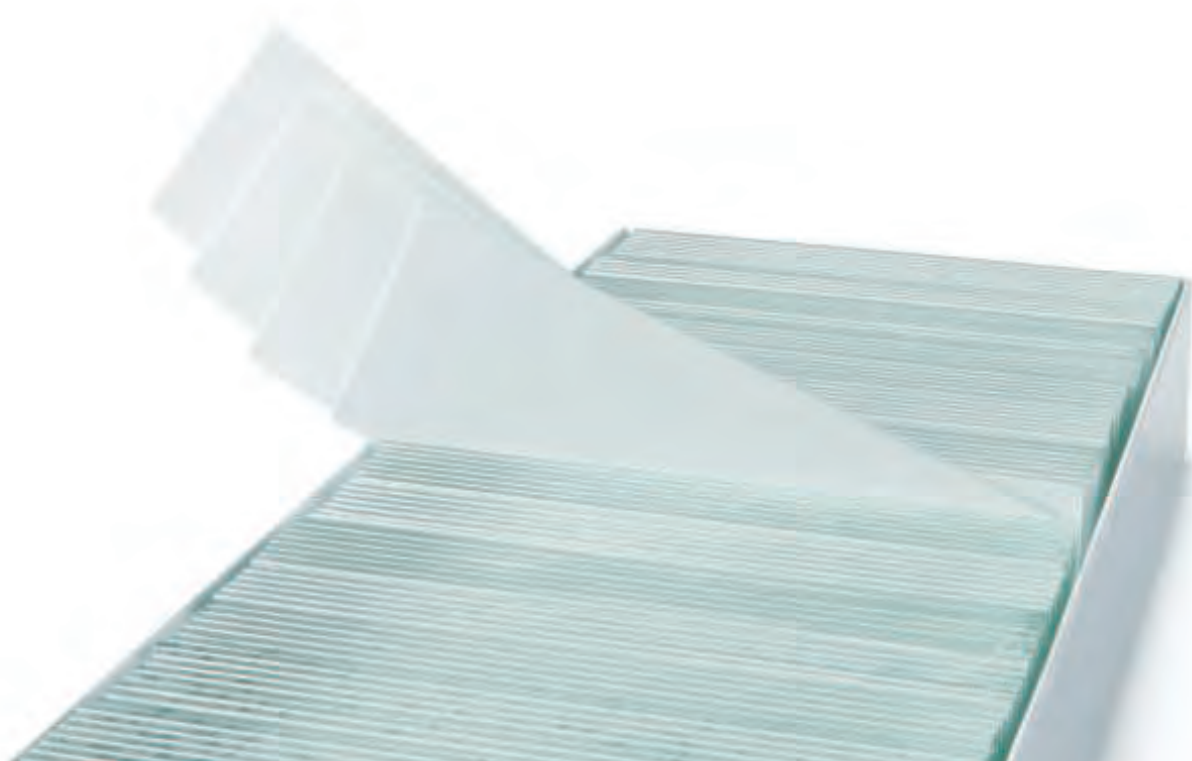

CN-, Diol- and NH₂-modified plates (TLC and HPTLC)

For special separation problems

CN-, Diol- and NH₂-modified silica sorbents are less polar than the classical silica phases and therefore well suited for separation of hydrophilic or charged substances.

The CN-modified plate is based on a silica gel 60 modified with a cyanopropyl group while the diol-modified plate utilizes a silica surface modified by a vicinal diol alkyl ether. These moderately polar plates with their intermediate properties fill a gap in the range of the silica plates allowing use in both normal phase and reversed phase systems. Due to their special features, all kinds of solvent systems can be used.

Especially the dual personality of the silica-CN plate allows unique two-dimensional separations to be achieved by using the normal phase mechanism in the first direction followed by the reversed phase mechanism in the second direction.

The amino-modified silica NH₂ plates provide weak basic ion exchange characteristics. These unique features enable the separation of charged compounds such as nucleotides, purines, pyrimidines, phenols and sulfonic acids using simple eluent mixtures. In addition, NH₂ modified silica plates allow for reagent-free detection of certain chemical substances by thermochemical fluorescence activation.

Because most substance separated on these modified plates are colorless, our modified plates contain the blue fluorescing, acid stable UV indicator F_{254s}. Samples which absorb short-wave UV at 254 nm are detected due to fluorescence quenching.

Ordering information – TLC modified silica gel 60, aluminium backed

Product	Ordering No.	Format [cm]	Contents of one package
Silica gel 60 NH ₂ F _{254s}	1.05533.0001	20 x 20	20 sheets

F_{254s}: Blue fluorescent indicator

Ordering information – TLC modified silica gel 60, glass backed

Product	Ordering No.	Format [cm]	Contents of one package
HPTLC silica gel 60 CN F _{254s}	1.16464.0001	10 x 10	25 plates
HPTLC silica gel 60 Diol F _{254s}	1.12668.0001	10 x 10	25 plates
HPTLC silica gel 60 Diol F _{254s}	1.05636.0001	20 x 10	25 plates
HPTLC silica gel 60 NH ₂	1.12572.0001	20 x 10	25 plates
HPTLC silica gel 60 NH ₂ F _{254s}	1.13192.0001	20 x 10	25 plates
HPTLC silica gel 60 NH ₂ F _{254s}	1.15647.0001	10 x 10	25 plates

Layer thickness: 200 µm | F_{254s}: Blue fluorescent indicator

► **Classical silica TLC plates (TLC)** For versatile and reliable routine analysis of a broad range of substances
page 98

► **High performance silica plates (HPTLC)** For fast analysis of complex samples for manual or instrumental use
page 103

Applications of CN-, Diol- and NH₂-modified silica

CN-, Diol- and NH₂-modified plates provide additional selectivities for a wide range of applications including:

- CN-silica: benzodiazepine derivatives, pesticides, plasticizers, tetracyclines, antibiotics, gallic acid esters and others.
- Diol-silica: glycosides, anabolic steroids, aromatic amines and particularly dihydroxybenzoic acids.
- NH₂-silica: charged compounds, such as nucleotides, phenols and sulfones.

Separation of oligo-nucleotides

Sample	1. ApUpG	0.1 %
	2. ApApU	0.1 %
	3. ApApC	0.1 %
	4. ApApA	0.1 %
Sample volume	300 nl	
Mobile phase	Ethanol-water (60/40 v/v) plus 0.2 mM lithium chloride	
Migration distance	7 cm	
Detection	UV 254 nm (TLC/HPTLC Scanner 2)	



Separation of oligo-nucleotides on a HPTLC NH₂-modified silica gel 60 plate

Cellulose TLC and HPTLC

For analysis of polar substances

Cellulose is an organic sorbent that is particularly suitable for the separation of hydrophilic substances by partition chromatography. Merck Millipore's cellulose plates include classical TLC or HPTLC plates for demanding high-performance separations. Classical TLC cellulose layers are based on a microcrystalline cellulose for standard separations, while the HPTLC cellulose layers utilize high-purity rod-shaped microcrystalline cellulose resulting in highly reduced diffusion of analytes for critical high-performance separations.

Cellulose plates are available with or without fluorescent indicator. The fluorescent indicator used is a special fluorescent pigment that is stimulated to intense blue fluorescent remission under long-wave UV light of 366 nm and under short-wave UV light of 254 nm.

These products are not intended for use as in-vitro diagnostics in terms of European Directive 98/79/EC. They are for research purposes only, for investigating in-vitro samples derived from the human body without any medical objective.

Ordering information – TLC cellulose, glass backed

Product	Ordering No.	Format [cm]	Contents of one package
Cellulose	1.05716.0001	20 x 20	25 plates
	1.05730.0001	10 x 20	50 plates
	1.05632.0001	10 x 10	100 plates
Cellulose F	1.05718.0001	20 x 20	25 plates
	1.05728.0001	10 x 20	50 plates

F: Fluorescence indicator with excitation wavelength 254/366 nm

Ordering information – TLC cellulose, aluminium backed

Product	Ordering No.	Format [cm]	Contents of one package
Cellulose	1.05552.0001	20 x 20	25 sheets
	1.05563.0001	500 x 20	1 roll
Cellulose F	1.05574.0001	20 x 20	25 sheets

Layer thickness: 100 µm | F: Fluorescence indicator with excitation wavelength 254/366 nm

Ordering information – TLC cellulose, plastic backed

Product	Ordering No.	Format [cm]	Contents of one package
Cellulose	1.05577.0001	20 x 20	25 sheets
Cellulose F	1.05565.0001	20 x 20	25 sheets

Layer thickness: 100 µm | F: Fluorescence indicator with excitation wavelength 254/366 nm

Ordering information – HPTLC cellulose, glass backed

Product	Ordering No.	Format [cm]	Contents of one package
HPTLC cellulose	1.05786.0001	20 x 10	50 plates
	1.05787.0001	10 x 10	25 plates
HPTLC cellulose F	1.15036.0001	20 x 10	50 plates
	1.15035.0001	10 x 10	25 plates

F: Fluorescence indicator with excitation wavelength 254/366 nm

Ordering information – HPTLC cellulose, aluminium backed

Product	Ordering No.	Format [cm]	Contents of one package
HPTLC cellulose	1.16092.0001	20 x 20	25 sheets

Layer thickness: 100 µm

Application of cellulose TLC and HPTLC

Typical applications of cellulose include the analysis of amino acids, carbohydrates, phosphates, nucleic acids and nucleic acids derivatives.

- Detection of abnormal increases of amino acids in clinical laboratories
- 2-dimensional separations such as amino acid "fingerprints"
- Metabolic studies

Separation of oligo-nucleotides

Sample	1. $(\text{NaPO}_3)_3$ 2. $\text{Na}_5\text{P}_3\text{O}_{10}$ 3. $\text{Na}_4\text{P}_2\text{O}_7$ 4. Na_2HPO_4
Sample volume	250 nl
Mobile phase	dioxane sol. 160 g TCA, 8 mL 25 % ammonia in 1 L water; 70/30
Migration distance	7 cm
Detection	586 nm (TLC/HPTLC Scanner, Camag)

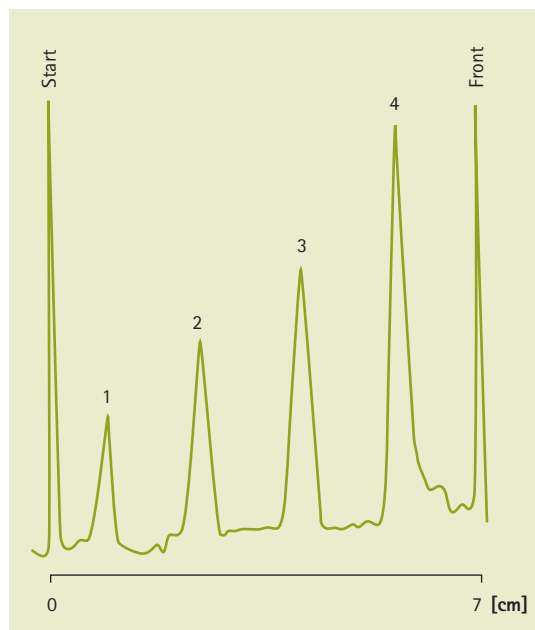

HPTLC cellulose is highly suited to separate polar compounds as demonstrated by the separation of phosphates

PEI (Polyethylenimine) Cellulose

For specific separations by ion-exchange chromatography

PEI Cellulose is polyethylenimine modified cellulose, which acts as a strongly basic anion exchanger. Due to these special characteristics, it is mainly useful to analyze substances with exchange-active groups such as amino acids, peptides and nucleotides or nucleosides.

Ordering information – PEI cellulose TLC, glass & plastic backed

Product	Ordering No.	Format [cm]	Backing	Contents of one package
PEI Cellulose F	1.05725.0001	20 x 20	glass	25 plates
PEI Cellulose F	1.05579.0001	20 x 20	plastic	25 sheets

Layer thickness: 100 µm | PEI cellulose plates should be stored at 0–4°C to reduce deterioration.

Application of PEI (Polyethylenimine) Cellulose

PEI cellulose has specific uses such as the analysis of nucleotides, nucleoside and nucleobases, vanadyl mandelic acid and sugar phosphates.

These products are not intended for use as in-vitro diagnostics in terms of European Directive 98/79/EC. They are for research purposes only, for investigating in-vitro samples derived from the human body without any medical objective.



Analysis of sugar phosphates with PEI cellulose

Concentrating zone plates (TLC, HPTLC, PLC)

Quick and easy sample application even of large volumes of diluted samples

Concentrating zone plates allow easy application of large volumes of diluted samples offering:

- Highly facilitated sample loading
- Better resolution due to uniformly sharp bands
- Includes a purification, sample preparation step

Merck Millipore's concentrating zone plates are based on different adsorption properties of two silica sorbents: a large-pore concentrating sorbent where the samples are applied, and a selective separation layer for the separation. Independent of shape, size or position of the spots, the sample always concentrates within minutes as a narrow band at the interface of the two adsorbents where the separation starts (see figure on page 118).

In addition, the concentrating zone can serve as a clean-up step for complex matrices, e.g. oils, cosmetics. Analytical TLC and HPTLC concentration zone plates provide concentrating areas of 2.5 cm while the concentrating zone of preparative plates (PLC) is 4 cm in width.

The special **HPTLC RP-18 modified silica concentrating zone plate** is optimized for the high-resolution separation of polycyclic aromatic hydrocarbons (PAH) according to DIN 38409-H13. Polycyclic aromatic hydrocarbons (PAH) are derived from organic material by pyrolysis or incomplete combustion. The main sources are the exhaust fumes of private and industrial furnaces, car exhaust and tobacco smoke. Since some PAH are carcinogenic, their determination is of great importance and maximum limits have been set, for example, for drinking water.

Ordering information – TLC concentrating zone plates

Product	Ordering No.	Format [cm]	Backing	Contents of one package
Silica gel 60 concentrating zone 2.5 x 20 cm	1.11845.0001	20 x 20	glass	25 plates
Silica gel 60 concentrating zone 2.5 x 10 cm	1.11844.0001	10 x 20	glass	50 plates
Silica gel 60 concentrating zone 2.5 x 20 cm *	1.05582.0001	20 x 20	aluminium	25 sheets
Silica gel 60 F ₂₅₄ concentrating zone 2.5 x 20 cm	1.11798.0001	20 x 20	glass	25 plates
Silica gel 60 F ₂₅₄ concentrating zone 2.5 x 10 cm	1.11846.0001	10 x 20	glass	50 plates
Silica gel 60 F ₂₅₄ concentrating zone 2.5 x 20 cm *	1.05583.0001	20 x 20	aluminium	25 sheets

Layer thickness: 250 µm / * 200 µm | F₂₅₄: Green fluorescent indicator

► **Classical silica TLC plates (TLC)** For versatile and reliable routine analysis of a broad range of substances
page 98

► **High performance silica plates (HPTLC)** For fast analysis of complex samples for manual or instrumental use
page 103

► **Preparative layer plates (PLC)** For enrichment of target analytes in mg quantities and sample clean-up
page 132

Concentrating zone plates (TLC, HPTLC, PLC)

Ordering information – HPTLC concentrating zone plates

Product	Ordering No.	Format [cm]	Backing	Contents of one package
HPTLC Silica gel 60 concentrating zone 2.5 x 20 cm	1.13749.0001	20 x 10	glass	50 plates
HPTLC Silica gel 60 concentrating zone 2.5 x 10 cm	1.13748.0001	10 x 10	glass	25 plates
HPTLC Silica gel 60 F ₂₅₄ concentrating zone 2.5 x 20 cm	1.13728.0001	20 x 10	glass	50 plates
HPTLC Silica gel 60 F ₂₅₄ concentrating zone 2.5 x 10 cm	1.13727.0001	10 x 10	glass	25 plates
HPTLC Silica gel 60 F ₂₅₄ concentrating zone 2.5 x 5 cm	1.13187.0001	5 x 10	glass	25 plates
HPTLC Silica gel 60 RP-18 F _{254s} concentrating zone 2.5 x 20 cm	1.15498.0001	20 x 10	glass	25 plates
HPTLC Silica gel 60 plate RP-18 concentrating zone 2.5 x 20 cm for PAH detection	1.15037.0001	20 x 10	glass	25 plates

Layer thickness: 200 µm | F₂₅₄: Green fluorescent indicator | F_{254s}: Blue fluorescent indicator

Ordering information – PLC concentrating zone plates, glass backed

Product	Ordering No.	Format [cm]	Layer thickness	Contents of one package
Silica gel 60 F ₂₅₄ concentrating zone 4 x 20 cm	1.13794.0001	20 x 20	0.5 mm	20 plates
	1.13792.0001	20 x 20	1 mm	15 plates
	1.13793.0001	20 x 20	2 mm	12 plates

F₂₅₄: Green fluorescent indicator

Concentrating zone plates (TLC, HPTLC, PLC)

Application

Concentrating zone plates highly facilitate manual sample application, of large or dilute samples.

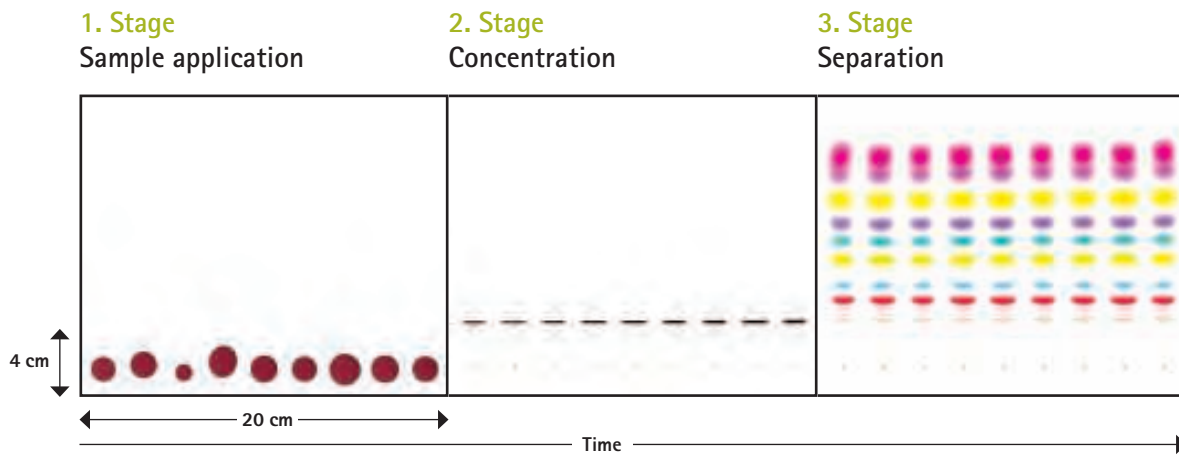

Stages of the development of a PLC concentrating zone plate silica gel 60. Separation of lipophilic dyes with toluene as mobile phase.

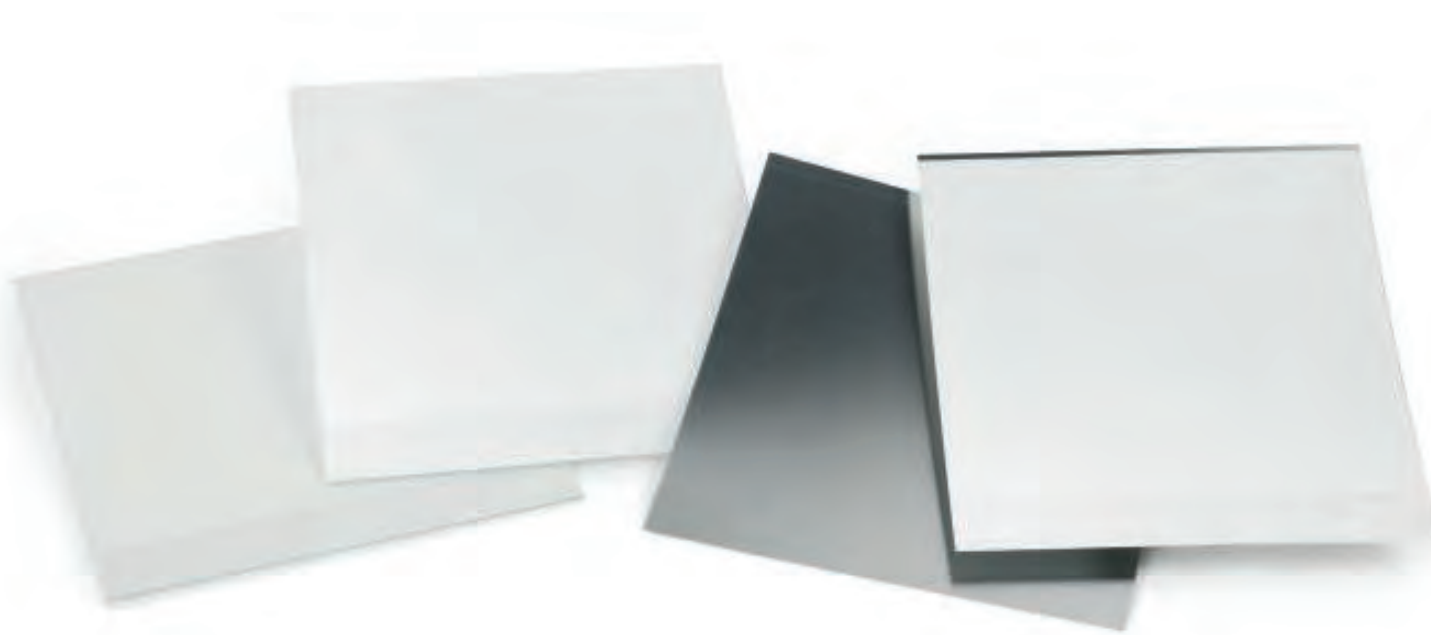

ProteoChrom® HPTLC plates

For peptide analysis

The new ProteoChrom® plates have been optimized for highly efficient separations especially for analysis of peptides and protein digests.

- Highly reproducible: optimized separation & staining procedures
- Convenient, easy-to-follow detailed protocols included
- Sensitive: extra thin layers of 100 µm
- Highly stable in water, ideal for use with aqueous solvent systems

ProteoChrom® HPTLC Silica gel 60 F₂₅₄ plates utilizes an extra thin layer of high-performance Merck Millipore silica gel providing highly efficient separation characteristics for 1-D analysis of peptides and protein digests. Due to the special binder composition, the plates are highly stable in water. Up to 20 peptides can be resolved and as little as 1-2 ng per band can be visualized.

ProteoChrom® HPTLC Cellulose sheets utilize an extra thin layer of optimized microcrystalline cellulose. Specially developed protocols for development and staining enable straightforward 2-D analysis in only 4 hours.

Each ProteoChrom® package includes an insert sheet with detailed instructions for solvent systems, running conditions and staining solution, enabling straightforward experiments without time-consuming optimization work.

The new ProteoChrom® plates open a new application field for Thin Layer Chromatography.

Ordering information – HPTLC LiChrospher® RP-modified silica gel 60

Product	Ordering No.	Format [cm]	Backing	Contents of one package
ProteoChrom® HPTLC silica gel 60 F _{254s}	1.05650.0001	20 x 10	glass	25 plates
ProteoChrom® HPTLC Cellulose	1.05651.0001	10 x 20	aluminium	25 sheets

F_{254s}: Blue fluorescent indicator

2-dimensional HPTLC of single protein digests

A. Fluorescamine staining



B. Staining with ninhydrin

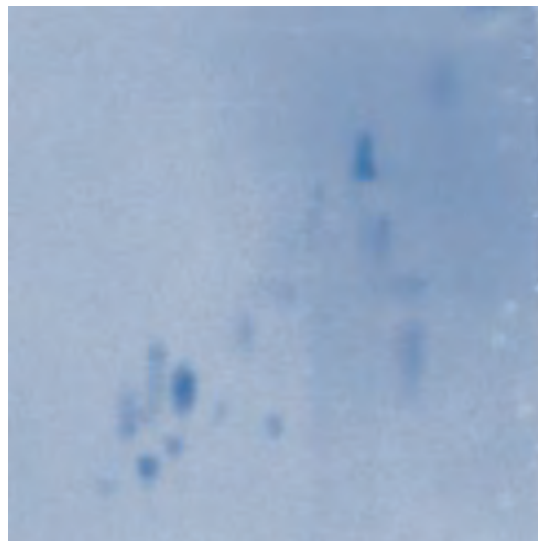

Cytochrome C tryptic digests were 2-D separated on ProteoChrom® HPTLC Cellulose sheet followed by either (A) fluorescamine staining, or (B) staining with ninhydrin.

Cytochrome C tryptic digests 2-D separated on ProteoChrom® HPTLC Cellulose sheet

Sample volume	5 µL
Concentration	2 mg/mL
Application system	Automatic TLC Sampler 4 (CAMAG)
Mobile phases	1st dimension: 2-butanol/pyridine/acetic acid/water (30/20/6/24), 1D 2nd dimension: 2-butanol/pyridine/ammonia (25 %) / water (39/34/10/26), 2D
Migration distance	5 cm
Migration time	1st dimension: 44 min 2nd dimension: 50 min
Staining	A: Fluorescamine B: Ninhydrin

1-dimensional separation of single protein digests

A. Fluorescamine staining

B. Staining with ninhydrin

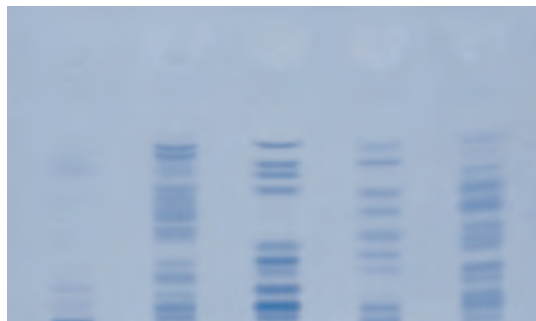
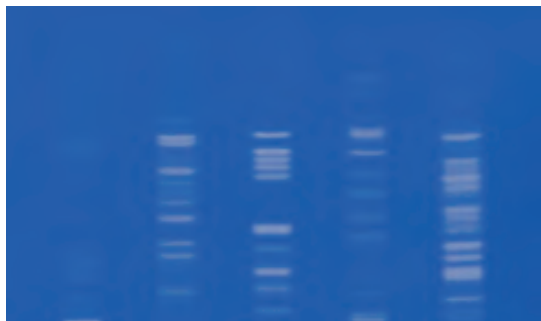

Tryptic digests of various proteins were separated on a ProteoChrom® HPTLC Silica gel 60 F_{254s} plate followed by either (A) fluorescamine staining, or (B) staining with ninhydrin.

Tryptic digests of various proteins separated on ProteoChrom® HPTLC Silica gel 60 F_{254s} plate

Sample volume	A: 1.5 µL B: 4 µL
Concentration	2 mg/mL
Application system	Automatic TLC Sampler 4 (CAMAG)
Mobile phases	2-butanol/pyridine/ammonia (25 %) / water (39/34/10/26)
Migration distance	5 cm
Migration time	45 min
Staining	A: Fluorescamine B: Ninhydrin

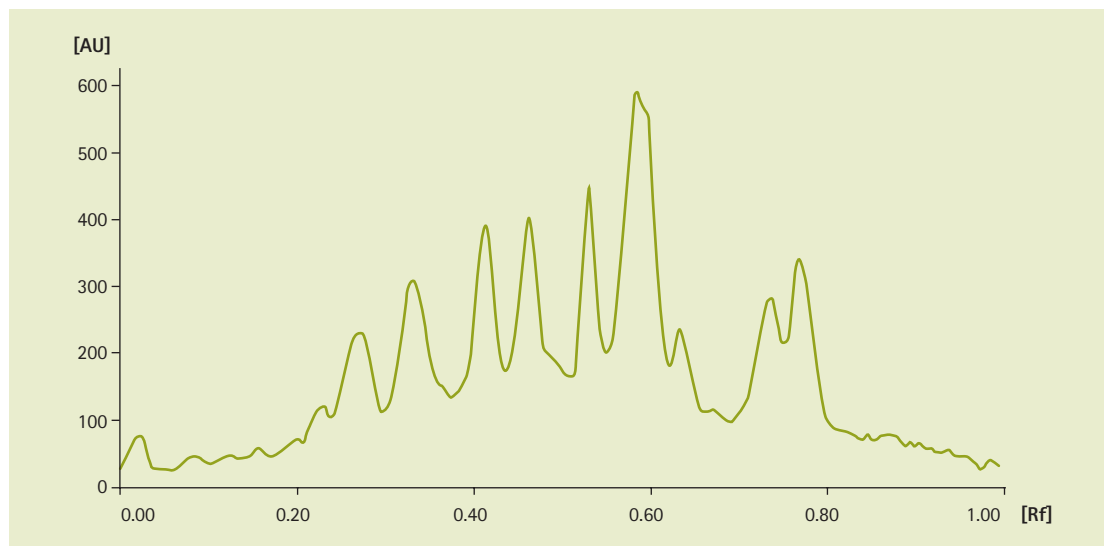

Densitogram of a tryptic digest of b-Casein. A tryptic digest of b-Casein was separated on a ProteoChrom® HPTLC Silica gel 60 F_{254s} plate followed by fluorescamine staining and scanned with a CAMAG TLC Scanner III in fluorescence mode at UV 366.

TLC silica gel 60G plates

Highly robust plates with gypsum as binder, fully compliant with international pharmacopeia

Traditionally, TLC monographs in pharmacopeia refer to products using silica G, containing gypsum as binder, or silica H with no foreign binder. There are about 200 monograph methods in the European Pharmacopeia (Ph Eur) referring to these plates. The United States Pharmacopeia (USP) does not distinguish between TLC plates with gypsum or organic binder, thus Merck Millipore standard plates can always be used.

Fully compliant with international pharmacopeia

These new TLC silica gel 60G plates are recommended for customers in QA/QC labs using older Ph Eur monograph methods, which require TLC plates with gypsum binder, and who do not wish to switch to classical Merck Millipore TLC plates with organic binders.

Merck Millipore's classical TLC plates fulfill the performance test requirements of Ph Eur for G plates with gypsum, even though they use modern organic binders. Today, many customers routinely use these classical TLC plates in place of gypsum plates, and indeed several monographs have been updated to officially confirm this change.

Ph Eur performance test for TLC/HPTLC plates

In addition to the standard Merck Millipore QC test, the new TLC silica gel 60G plates are tested using the TLC performance test described by Ph Eur.

Description: Chromatographic separation. Apply to the plate an appropriate volume (10 μm for a normal TLC plate and 1 μL to 2 μL for a fine particle size plate) of TLC performance test solution R (Reagent 1116600). Develop over a path length two-thirds of the plate height, using a mixture of 20 volumes of methanol R and 80 volumes of toluene R. The plate is not satisfactory, unless the chromatogram shows four clearly separated spots, the spot of bromocresol green with an R_f value less than 0.15, the spot of methyl orange with an R_f value in the range of 0.1 to 0.25, the spot of methyl red with an R_f value in the range of 0.35 to 0.55 and the spot of Sudan red G with an R_f value in the range of 0.75 to 0.98.



The chromatogram shows four clearly separated spots under Ph Eur test conditions and fulfils Ph Eur requirements (see R_f values).

Ph Eur performance test on Merck Millipore TLC silica gel 60G plate

Parameter	Specification [h R_f values*]	Typical value
Separation	4 clearly separated spots	passed
Bromocresol green	<15	5
Methyl orange	10 – 25	10
Methyl red	35 – 55	38
Sudan red G	75 – 98	82

* $hR_f = R_f \times 100$

Ordering information – TLC silica gel 60G, glass backed

Product	Ordering No.	Format [cm]	Backing	Contents of one package
TLC silica gel 60G F ₂₅₄	1.00390.0001	20 x 20	glass	25 plates
TLC Silica gel 60G	1.00384.0001	20 x 20	glass	25 plates

Both new plates have similar separation performance to our classical TLC plates; the only difference is that gypsum is used as binder.

Applications

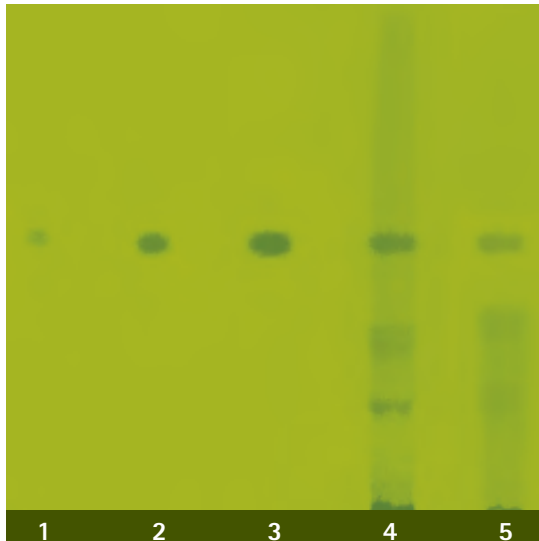

A.*Silica Gel 60G F₂₅₄ (chromaticity of the picture was modified)

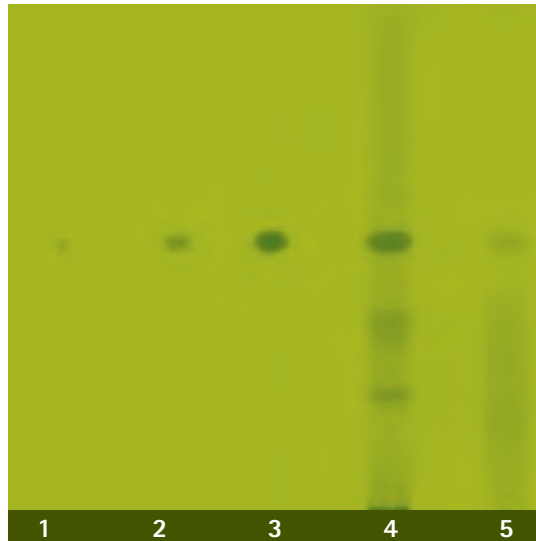

B.*Silica Gel 60 F₂₅₄ (chromaticity of the picture was modified)

Samples	Track	Application volume
	1: Caffeine	0.5 µL (0.1 mg/mL)
	2: Caffeine	1.0 µL (0.1 mg/mL)
	3: Caffeine	2.0 µL (0.1 mg/mL)
	4: Coffee	2.0 µL
	5: Coca-Cola	2.0 µL
Sample application	Capillaries 0.5 µL, 1 µL and 2 µL	
Stationary phase	A. TLC plates silica gel 60 G F ₂₅₄ [Ord. No. 1.00390.0001] B. TLC plates silica gel 60 F ₂₅₄ [Ord. No. 1.05715.0001]	
Chromatography	In the normal flat bottom chamber 20 x 20 cm with Isopropanol / n-Heptane / water 7:3:1	
Migration distance	100 mm	
Migration time	145 min	
Documentation	UV 254 nm	

Multiformat plates (TLC and HPTLC)

Multiple sizes in one single glass plate

Merck Millipore multiformat glass plates are pre-scored for easy snapping with the fingers to smaller sizes.

- Easy snapping with the fingers
- Up to 7 formats in one plate

Multiformat plates utilize the same proven silica coating as the corresponding TLC or HPTLC plate delivering chromatograms that are identical to those on normal non-scored plates.

The number of possible plates depends on the scoring, for example: For a 20 x 20 cm plate scored in segments of 5 x 10 cm, up to seven different formats are possible: 20 cm x 20 cm, 15 cm x 20 cm, 10 cm x 20 cm, 5 cm x 20 cm, 10 cm x 15 cm, 10 cm x 10 cm, 5 cm x 10 cm

Ordering information – Multiformat plates

Product	Ordering No.	Scored [cm]	Number of plates possible	Contents of one package
Multiformat silica gel 60 F ₂₅₄ ex 20 x 20	1.05620.0001	5 x 10	200	25 plates
Multiformat silica gel 60 F ₂₅₄ ex 20 x 20	1.05608.0001	5 x 20	80	20 plates
HPTLC Multiformat silica gel 60 F ₂₅₄ ex 10 x 10	1.05635.0001	5 x 5	100	25 plates
HPTLC Multiformat silica gel 60 ex 10 x 10	1.05644.0001	5 x 5	400	100 plates

F₂₅₄: Green fluorescent indicator

Application of multiformat plates



Note: To prevent the glass backing from uncontrolled and irregular breaking avoid putting plates directly on hot metal plates, drying cabinets or plate heaters after development or staining. When heat drying is necessary, use distance holders of low thermal conductivity between glass and hot metal plate i.e. glass rods or similar.

► **Classical silica TLC plates (TLC)** For versatile and reliable routine analysis of a broad range of substances
page 98

► **High performance silica plates (HPTLC)** For fast analysis of complex samples for manual or instrumental use
page 103

► **Preparative layer plates (PLC)** For enrichment of target analytes in mg quantities and sample clean-up
page 132

GLP plates (TLC and HPTLC)

With individual laser coding for GLP applications

Laser coded GLP plates have been specifically developed for working according to GLP.

The plates carry item, batch and individual plate number on the top of every single plate enabling for convenient back tracing of article, batch, and individual plate number. Every plate can easily be documented and archived.

Based on the same proven Merck Millipore silica as TLC or HPTLC, GLP plates provide the same unsurpassed separation performance as the corresponding TLC or HPTLC plates. GLP coded plates are available as TLC or HPTLC grade in various formats, without or with fluorescence indicator F_{254} that is stimulated to green emission at 254 nm.

Ordering information – GLP plates, glass backed

Product	Ordering No.	Format [cm]	Contents of one package
TLC GLP silica gel 60 F_{254} ¹⁾	1.05566.0001	20 x 20	25 plates
	1.05702.0001	10 x 20	25 plates
HPTLC GLP silica gel 60 F_{254}	1.05564.0001	10 x 10	25 plates
HPTLC GLP silica gel 60	1.13326.0001	10 x 20	25 plates
HPTLC GLP silica gel 60 F_{254}	1.05613.0001	10 x 20	25 plates

1) Layer thickness: 250 μm | F_{254} : Green fluorescent indicator

Laser coded GLP plates



GLP-Plate with additional information

TLC and HPTLC MS-grade plates for mass spectrometry

In 1969, Prof. R.E. Kaiser reported the coupling of thin-layer chromatography with mass spectrometry (MS) for the first time. TLC spots were heated and desorbed into a gas stream in front of the source of a mass spectrometer. Later H.J. Issaq demonstrated the use of multi-dimensional TLC coupled to MS, where separated zones were eluted from the TLC plate with methanol and introduced into the MS using the Eluchrom interface (CAMAG special products). Since then, many TLC-MS publications have been made, in particular in the last 3-4 years as interest has strongly grown. Today, coupling TLC plates to mass spectrometry is a new field of high interest, which will contribute strongly to the progress of planar chromatography, today and in the future.

Key benefits of TLC-MS are:

- Mass spectra are obtained quickly by direct sample access on the TLC plate at room temperature – high quality spectra are obtained with low background signal.
- Targeted recording of mass spectra on zones or lines of interest is performed after the TLC chromatogram has been developed, thus providing high efficiency.
- One particular advantage of TLC-MS and HPTLC-MS is the flexibility in choosing mobile phases for a separation. By contrast, with standard LC-MS coupling using HPLC, some mobile phases cannot be used (e.g. inorganic buffers).

High efficiency / high resolution

- The selectivity of MS-grade plates is the same as Merck Millipore standard TLC and HPTLC plates
- The detection limit of HPTLC-MS-grade plates is in the lower nanogram range

Price of new products

- Reasonably compared to our standard TLC/HPTLC products

Separation performance

- The separation performance of the new products is equivalent to the standard TLC/HPTLC plates, so that the method with standard TLC plates can be directly transferred to MS-grade plates.

Cleanness

- The important difference between MS-grade plates and standard Merck Millipore plates is that the new MS-grade products are much cleaner (more sensitive, reduced background signals).

Compatible with different TLC-MS techniques

- Elution-based techniques
- Desorption-based techniques



TLC and HPTLC MS-grade plates for mass spectrometry

The techniques for coupling TLC with mass spectrometry can be divided into (a) elution-based and (b) desorption-based techniques. Both approaches are offline, and both are performed after the separation is finished and the plate is dried. The sample transfer to the MS is fast and typically takes less than one minute.

A) With elution-based techniques, the analyte on the silica plate is dissolved in a solvent and transferred to the mass spectrometer in the liquid phase (see CAMAG interface).

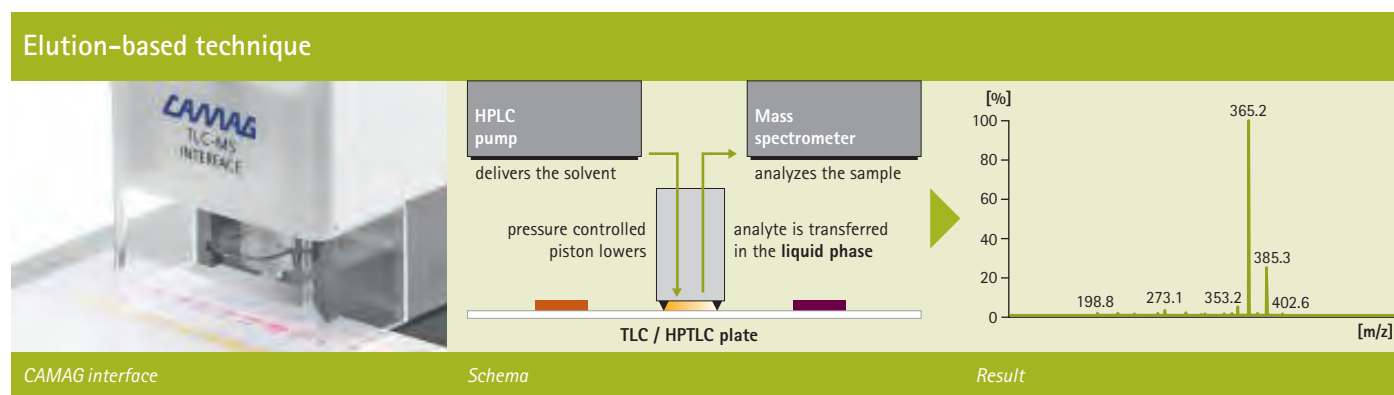

B) With desorption-based techniques, the analyte is vaporized from the silica and transferred to the MS in the gas phase. Vaporization techniques include gas beam, ion bombardment and MALDI (matrix assisted laser desorption / ionization) or DART (direct analysis in real time).

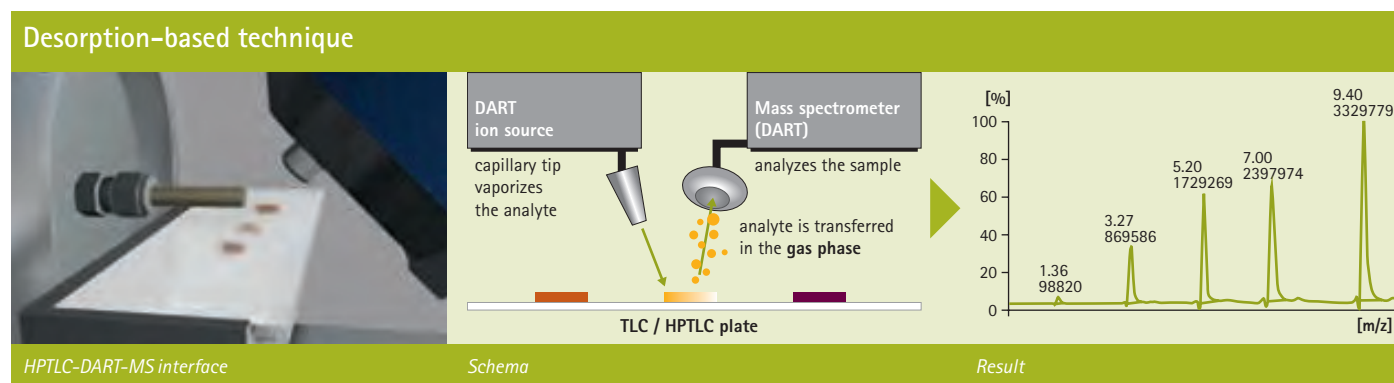

TLC and HPTLC MS-grade plates for mass spectrometry

Comparison of HPTLC MS-grade glass plates with Merck Millipore standard HPTLC glass plates under same chromatographic conditions

The following experimental results demonstrate the enhanced sensitivity of TLC-MS-grade plates:

MS background signal measurement using a standard HPTLC silica gel 60 F₂₅₄ glass plate [Ord. No. 1.05642.0001] with mobile phase acetonitrile/water (95/5).

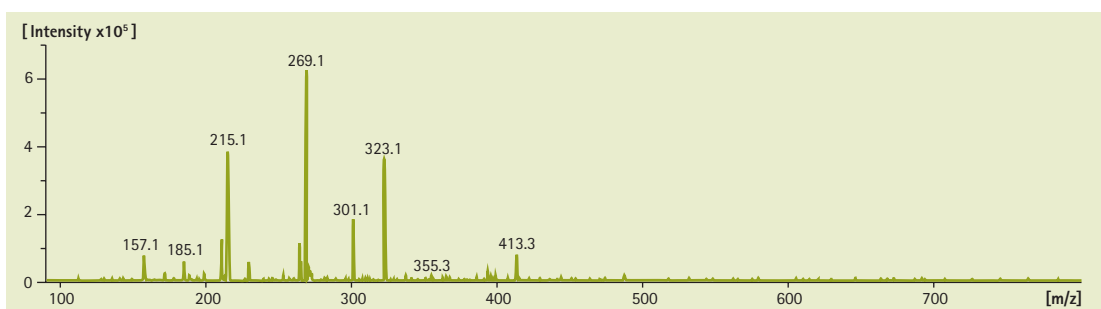

MS background signal measurement using an **MS-grade** HPTLC silica gel 60 F₂₅₄ glass plate [Ord. No. 1.00934.0001] with mobile phase acetonitrile/water (95/5).

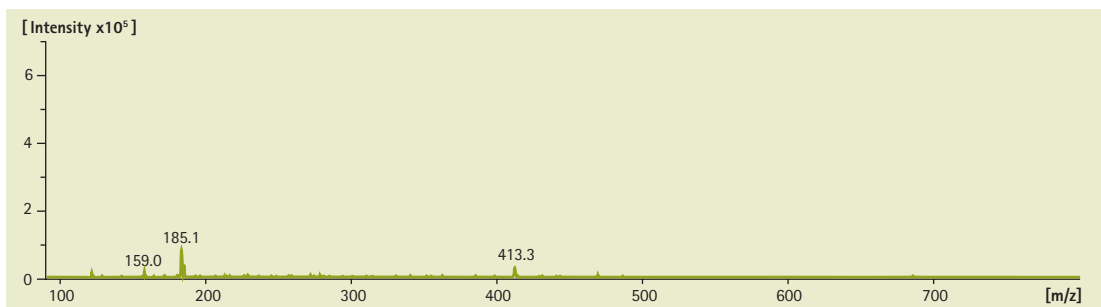

This clearly demonstrates that MS-grade plates have very low background signal compared to standard HPTLC plates.

Trace measurement of caffeine [sample: 20 ng caffeine (MH⁺) 195.1] on a HPTLC silica gel 60 F₂₅₄ **MS-grade** glass plate [Ord. No. 1.00934.0001] with mobile phase acetonitrile/water (95/5) + 0.1 % formic acid

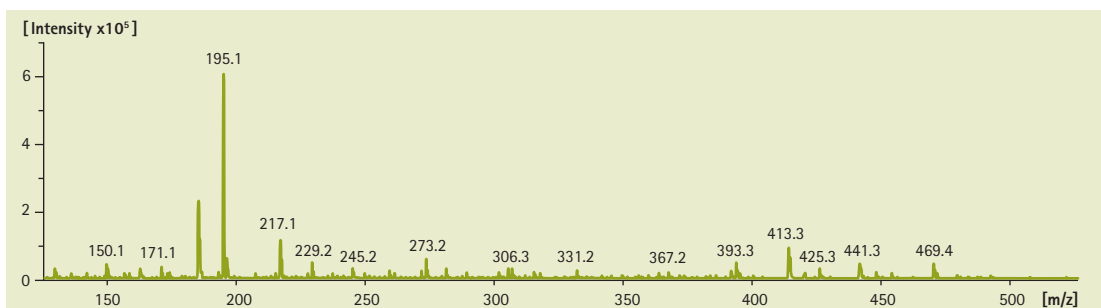

ESI-MS mass spectrum of caffeine, measured from a 20 nanogram TLC spot

TLC and HPTLC MS-grade plates for mass spectrometry

Ordering information – TLC and HPTLC MS-grade plates for mass spectrometry

Product	Ordering No.	Format [cm]	Backing	Contents of one package
TLC silica gel 60 F ₂₅₄ MS-grade	1.00933.0001	20 x 20	glass	25 plates
HPTLC silica gel 60 F ₂₅₄ MS-grade	1.00934.0001	20 x 10	glass	25 plates
HPTLC silica gel 60 RP18 F _{254s} MS-grade	1.51161.0001	20 x 10	glass	25 plates
HPTLC silica gel 60 F ₂₅₄ MS-grade for MALDI*	1.51160.0001	5 x 7.5	aluminium	20 sheets

* only aluminium plates are suitable for MALDI



TLC and HPTLC MS-grade plates for mass spectrometry

Applications

A) Determination of UV-Filter in sun cream on HPTLC Silica gel 60 RP-18 F_{254s} MS-grade plates

Chromatographic conditions

Plate	HPTLC Silica gel 60 RP-18 F _{254s} MS-grade 20 x 10 cm [Ord. No. 1.51161.0001]
Mobile Phase	Methanol [Cat. No. 106018] / Acetonitril [Cat. No. 100030] (v/v: 9:1)
Migration distance	Migration distance 6 cm (migration time 15 min)
Chamber	Normal chamber without chamber saturation
Detection	UV 254 nm
Mass spectrometry	Identification by coupling the TLC- MS Interface (CAMAG) with the Advion expression CMS mass spectrometer (+)-ESI mode.
Eluent	Acetonitrile / Water 95:5 + 0.1 % TFA.
Sample preparation	1 g sun cream was stirred in 10 mL 2-Propanol 15 minutes. Application by spraying 8 mm bands with CAMAG ATS4.

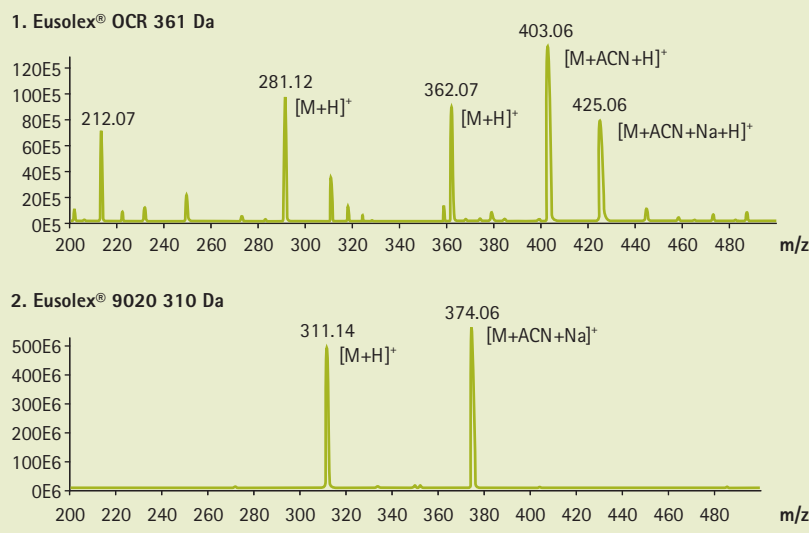
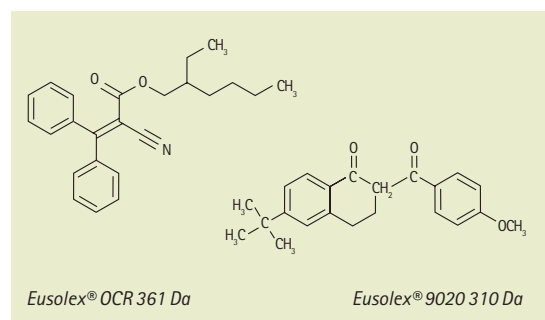

Chromatographic data

Track No.	Compounds	Concentration [mg/mL]	Solvent	Application volume [μL]	hRf
1, 2, 3	Eusolex® OCR	1.0	Ethanol	1.0 / 2.0 / 3.0	66
4, 5, 6	Eusolex® 9020	1.0	Ethanol	1.0 / 2.0 / 3.0	51
7, 8, 9	Sun cream A	-	2-Propanol	1.0 / 2.0 / 3.0	51, 66
10, 11, 12	Sun cream B	-	2-Propanol	1.0 / 2.0 / 3.0	51, 66

B) Separation and identification of Peptides on HPTLC Silica gel 60 F₂₅₄ MS-grade plates for MALDI

Chromatographic conditions

Plate	HPTLC Silica gel 60 F ₂₅₄ MS-grade for MALDI 5 x 7.5 cm aluminium foils [Ord. No. 1.51160.0001]
Mobile Phase	2-Butanol [Cat. No. 109630] / Pyridine [Cat. No. 109728] / Ammonia (25 %) [Cat. No. 105432] (v/v): Water 39:20:10:31
Migration distance	Migration distance 5 cm (migration time 51 min)
Chamber	Normal chamber without chamber saturation
Derivatization	Fluorescamin
Detection	UV 366 nm
Mass spectrometry	Matrix application was performed by dip coating protocol with DHB [Cat. No. 841745] and Di-Ammonium Phosphate in Acetonitrile [Cat. No. 100029] / Water + 0.1 % TFA [Cat. No. 108262] (v/v 90:10) TLC-MALDI-Imaging using MALDI-TOF MS (Ultraflexxtreme) from Bruker at 1000Hz
Sample preparation	Bruker Peptide Calibration Standard I in 125 µL Acetonitrile / Water + 0.1 % TFA 1:2, 10 µL injection Application by spraying 6 mm bands with CAMAG ATS4

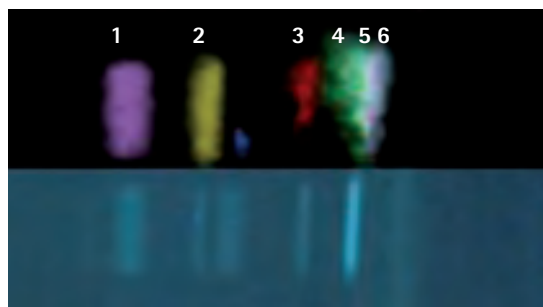
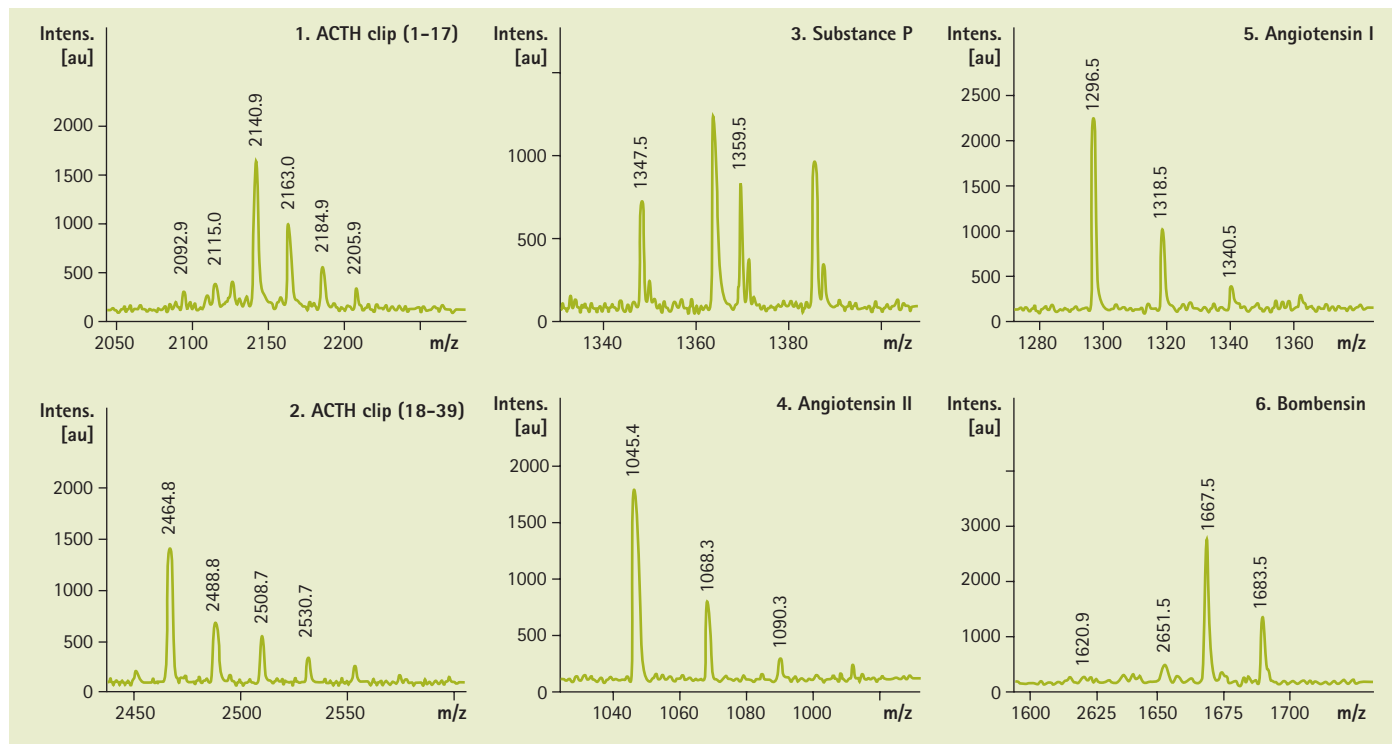

Summary

The separation efficiency and selectivity of both new MS-grade plates is equivalent to the standard TLC/HPTLC plates; the only difference is that the new products are much cleaner and have fewer impurities in the silica gel 60 matrix than the standard plates. This allows trace analysis with mass spectrometry detection in the nanogram range (see figure "ESI-MS mass spectrum of caffeine" page 128).

Preparative layer plates (PLC)

For enrichment of target analytes in mg quantities and sample clean-up

Preparative Thin Layer Plates (PLC) allow the separation of mg up to gram samples using up to 2 mm thick layers. PLC plates are based on the same proven Merck Millipore silica binder technology as analytical TLC plates. Merck Millipore's preparative plates are available with layers of silica gel, RP-18-modified silica or aluminium oxide in several layer thicknesses, ranging from 0.5 mm to 2 mm with or without fluorescent indicator.

In PLC, samples are typically applied as a band across the whole width of the plate and substances are visualised almost exclusively by UV detection. The substance can be isolated by extraction after the spot has been scraped from the layer. Just as in analytical TLC, PLC plates with concentration zone highly facilitate sample application.

PLC plates are highly suitable for a variety of preparative applications including: Cleaning and enrichment of synthetic reaction mixtures, natural products, plant extracts and biotechnological products.

Ordering information – PLC silica gel 60, glass backed

Product	Ordering No.	Format [cm]	Layer thickness	Contents of one package
PLC silica gel 60	1.13894.0001	20 x 20	0.5 mm	20 plates
	1.05745.0001	20 x 20	2 mm	12 plates
PLC silica gel 60 F ₂₅₄	1.05744.0001	20 x 20	0.5 mm	20 plates
	1.13895.0001	20 x 20	1 mm	15 plates
	1.05717.0001	20 x 20	2 mm	12 plates
PLC silica gel 60 F ₂₅₄ + F ₃₆₆	1.05637.0001	20 x 20	2 mm	12 plates

F₂₅₄: Green fluorescent indicator

Ordering information – PLC RP-modified silica gel 60, glass backed

Product	Ordering No.	Format [cm]	Layer thickness	Contents of one package
PLC silica gel 60 RP-18 F _{254s}	1.05434.0001	20 x 20	1 mm	15 plates

F_{254s}: Blue fluorescent indicator

Ordering information – PLC aluminium oxide 60, glass backed

Product	Ordering No.	Format [cm]	Layer thickness	Contents of one package
PLC aluminium oxide 60 F ₂₅₄	1.05788.0001	20 x 20	1.5 mm	12 plates

F₂₅₄: Green fluorescent indicator

Ordering information – PLC aluminium oxide 150, glass backed

Product	Ordering No.	Format [cm]	Layer thickness	Contents of one package
PLC aluminium oxides 150 F ₂₅₄	1.05726.0001	20 x 20	1.5 mm	12 plates

F₂₅₄: Green fluorescent indicator

Bulk sorbents for preparation of TLC plates

Standardized sorbents for reliable results

Silica gel 60 sorbent is the most versatile and successful material used in Thin Layer Chromatography. Different grades of silica gel 60 sorbents with a particle size of 5-40 µm are offered: silica with gypsum as binder, silica without any foreign binder, and silica gel with fluorescence indicator to suit a broad range of TLC and PLC needs. In addition, high quality aluminium oxide, cellulose microcrystalline and kieselguhr are offered.

Self-coating of layers is time consuming and requires experimental experience for high quality results. For classical TLC, particularly for quantitative work we highly recommend the use of pre-coated plates.

Ordering information – Silica gel 60 for TLC and PLC plates (particle size 5 – 40 µm)

Product	Ordering No.	Package	Contents of one package	Method
Silica gel 60 G	1.07731.1000	Plastic	1 kg	Classical TLC
	1.07731.5000	Tin	5 kg	
	1.07731.9025	Tin	25 kg	
Silica gel 60 G F ₂₅₄	1.07730.1000	Plastic	1 kg	Classical TLC
	1.07730.5000	Tin	5 kg	
	1.07730.9025	Tin	25 kg	
Silica gel 60 G F ₂₅₄ *	1.11678.1000	Plastic	1 kg	TLC
Silica gel 60 H	1.07736.1000	Plastic	1 kg	TLC
	1.07736.2500	Tin	2.5 kg	
	1.07736.9025	Tin	25 kg	
Silica gel 60 H *	1.11695.1000	Plastic	1 kg	TLC
Silica gel 60 H F ₂₅₄	1.07739.1000	Plastic	1 kg	TLC
	1.07739.2500	Tin	2.5 kg	
	1.07739.9025	Tin	25 kg	
Silica gel 60 H F ₂₅₄ + F ₃₆₆	1.07741.1000	Plastic	1 kg	TLC
Silica gel 60 P F ₂₅₄	1.07747.1000	Plastic	1 kg	PLC
	1.07747.2500	Tin	2.5 kg	
	1.07747.9025	Tin	25 kg	
Silica gel 60 P F ₂₅₄ + F ₃₆₆	1.07748.1000	Plastic	1 kg	PLC
	1.07748.2500	Tin	2.5 kg	
Silica gel 60 P F ₂₅₄ with gypsum	1.07749.1000	Plastic	1 kg	PLC
	1.07749.2500	Tin	2.5 kg	
	1.07749.9025	Tin	25 kg	

* Mean particle size 15 µm | F₂₅₄: Green fluorescent indicator | H: Without foreign binder | G: With gypsum | P: For preparative work

Bulk sorbents for preparation of TLC plates

Ordering information – Aluminium oxides for TLC and PLC (particle size 5 – 40 µm)

Product	Ordering No.	pH of 10 % aqueous suspension	Package	Contents of one package	Method
Aluminium oxide 60 G neutral	1.01090.2500	7.5	Plastic	2.5 kg	TLC
	1.01090.9025	7.5	Plastic	25 kg	TLC
Aluminium oxide 60 G F ₂₅₄ neutral	1.01092.0500	7.5	Plastic	500 g	TLC

F₂₅₄: Green fluorescent indicator

Ordering information – Other sorbents for TLC

Product	Ordering No.	Particle size	Package	Contents of one package
Cellulose microcrystalline	1.02330.0500	<20 µm	Plastic	500 g



Accessories

TLC Sprayer Accessories

Even and very finely dispersed spray solution is a prerequisite for optimal staining of TLC plates to visualize colorless substances. The Merck Millipore TLC sprayer allows spraying derivatization reagents homogeneously onto the developed chromatograms to detect colorless substances. It is equipped with two different spray heads of 0.8 mm and 1.25 mm optimized for low- and for high-viscosity solutions respectively. The electro-pneumatically operated sprayer uses compressed air driven by accumulator power and inductive charging.

Our ready-to-use spray solutions come in special 100 mL packages that can be screwed directly to the sprayer, eliminating cumbersome pouring of the solutions.

Spray solution

The three most common spray solutions used in TLC are offered as ready-to-use solutions optimally packaged to fit directly onto the sprayer.

UV lamp

Two UV lamps powered by five 1.5 V baby cells (UM2) are intended for the quick detection of substances under short- or long-wavelength UV light.

Ordering information – Accessories and auxiliaries

Product	Ordering No.	Contents of one package
Micro capillaries 2.0 µl	1.10290.0001	50 capillaries
UV lamp 254 nm	1.12537.0001	1 unit
UV lamp 366 nm	1.13203.0001	1 unit
TLC sprayer with two spray heads	1.08540.0001	1 unit
Spray heads for TLC sprayer	1.08541.0001	6 pieces: 5 x 0.8 mm bore / 1 x 1.25 mm bore
Glass bottles 50 mL	1.10647.0001	10 bottles
Glass bottles 100 mL	1.10646.0001	10 bottles

Ordering information – Ready-to-use spray solutions

Product	Ordering No.	Solvent	Package	Contents of one package
Dragendorff-Reagent	1.02035.0100	Acetic acid/ethyl acetate/water	glass	100 mL
Molybdato-phosphoric acid	1.00480.0100	2-propanol	glass	100 mL
Ninhydrin	1.06705.0100	2-propanol	glass	100 mL

Technical appendix

TLC performance is essentially determined by the stationary phase (e.g. silica, cellulose, ...) and the mobile phase. Optimal chromatograms can be obtained by variation of these parameters.

Selection of separation conditions

The triangle scheme according to Stahl provides a basic tool for the selection of separation conditions for adsorption (A) and for partition chromatography (B): rotating one selected parameter at the applicable position automatically defines the other parameters.

Scheme for determination of suitable chromatographic separation conditions

Adsorption

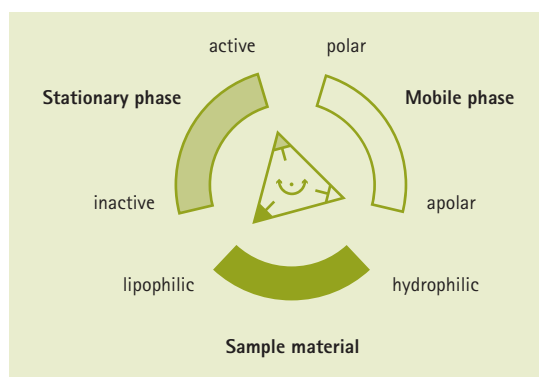

Partition

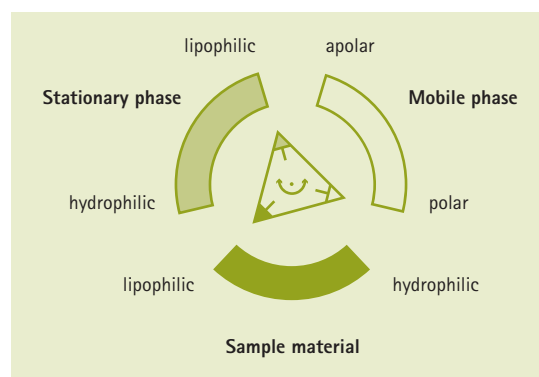

The eluotropic series of solvents, where the solvents are listed in order of increasing elution power, is helpful for choosing a suitable mobile phase for a particular separation problem. The following table lists an eluotropic series for silica gel as stationary phase (eluotropic series for silica gel acc. to Halpaap).

Sample application

Samples can be applied as spots or narrow bands. In both cases their size and width will influence the separation. As a general rule, samples should be applied as narrow as possible. Manual application is achieved with capillaries or a pipette. For large samples volumes, concentrating zone plates will highly facilitate sample application. For quantitative work, semi-automated or automated sample application is recommended for reliable, reproducible results.

Influencing parameters

Solvent	Polarity index acc. to Synder	Dielectric constant DK [20 resp. 25°C]	Molar mass [g/mol]	Boiling point [°C]	Vapor pressure [20°C/mbar]	MAK value 1994* [mL/m ³ = ppm]
n-Heptane	-	1.9	100.21	98.4	48	500
n-Hexane	0.0	1.9	86.18	68.9	160	50
Cyclohexane	0.0	2.0	84.16	80.7	104	300
Isooctane	0.4	1.9	114.23	99.2	51	500
1,1,2-Trichlorotrifluoroethane	-	2.4	187.38	47.7	368	500
Carbon Tetrachloride	1.7	2.2	153.82	76.5	120	10
Toluene	2.3	2.4	92.14	110.6	29	100
tert-Butyl methyl ether	2.9	-	88.15	55.2	417	-
Chloroform	4.4	4.8	119.38	61.7	210	10
Dichloroethane	3.7	10.6	98.97	83.4	87	5
Dichloromethane	3.4	9.1	84.93	40.0	453	100
1-Butanol	3.9	17.8	74.12	117.2	6.7	100
Acetonitrile	6.2	37.5	41.05	81.6	97	40
2-Propanol	4.3	18.3	60.10	82.4	43	400
Ethyl acetate	4.3	6.0	88.10	77.1	97	400
Acetone	5.4	20.7	58.08	56.2	233	1000
Ethanol	5.2	24.3	46.07	78.5	59	1000
1,4-Dioxane	4.8	2.2	88.11	101.0	41	50
Tetrahydrofuran	4.2	7.4	72.11	66.0	200	200
Methanol	6.6	32.6	32.04	65.0	128	200
Water	9.0	80.2	18.01	100.0	23	-

* BIA-Report 1/94

Other parameters influencing performance

TLC is usually carried out in an open separation system and a variety of further factors influence the quality of the result.

Main factors are:

- Sample application
- Relative humidity
- Layer reproducibility
- Impurities of the solvent

Humidity

TLC plates, especially the widely used unmodified silica sorbent, adsorb water. Changes in relative humidity can effect a number of important factors e.g. Rf values, selectivity, solvent front migration and the position of multiple fronts. The relative humidity of the atmosphere is therefore critical for reproducible work. If constant humidity can not be assured, we suggest pre-conditioning the plates for 30 min over saturated salt solutions or sulfuric acid solutions of defined concentration. Relative humidity above selected salt solutions is given in Table.

TLC plates

Saturated salt solution containing a large quantity of undissolved salt	Relative humidity above solution [20°C / %]
di-Sodium hydrogenphosphate $\text{Na}_2\text{HPO}_4 \cdot 12 \text{H}_2\text{O}$	95
Sodium carbonate $\text{Na}_2\text{CO}_3 \cdot 10 \text{H}_2\text{O}$	92
Zinc sulfate $\text{ZnSO}_4 \cdot 7 \text{H}_2\text{O}$	90
Potassium chloride KCl	86
Ammonium sulfate $(\text{NH}_4)_2\text{SO}_4$	80
Sodium chloride NaCl	76
Sodium chlorate NaClO_3	75
Sodium nitrite NaNO_2	65
Ammonium nitrate NH_4NO_3	63
Calcium nitrate $\text{Ca}(\text{NO}_3)_2 \cdot 4 \text{H}_2\text{O}$	55
Sodium dichromate $\text{Na}_2\text{Cr}_2\text{O}_7 \cdot 2 \text{H}_2\text{O}$	52
Potassium carbonate K_2CO_3	45
Zinc nitrate $\text{Zn}(\text{NO}_3)_2 \cdot 6 \text{H}_2\text{O}$	42
Chromium trioxide CrO_3	35
Calcium chloride $\text{CaCl}_2 \cdot 6 \text{H}_2\text{O}$	32
Potassium acetate $\text{K}(\text{OOCCH}_3)$	20
Lithium chloride $\text{LiCl} \cdot \text{H}_2\text{O}$	15

Thin Layer Chromatography and Pharmacopeias (Ph Eur, BP, USP, DAB)

Traditionally some TLC monographs in a pharmacopeia refer to TLC products using silica G containing gypsum as binder or silica H without any foreign binder.

Pre-coated plates without binder or with gypsum have a very fragile surface and cannot be packed and transported without distortion of the layer. Therefore G and H plates are not generally available commercially; G-plates are now available from Merck Millipore. Please ask your local Merck Millipore representative for further information.

Merck Millipore plates contain an organic binder that was especially chosen to cause as few chromatographic deviations as possible in comparison to sorbents containing G or H.

There is no restriction by Ph Eur on the use of pre-coated plates containing other organic binders than G or H, presuming the chromatographic results are comparable to the results obtained with "G" or "H" plates. The latter has to be confirmed individually.

Thin Layer Chromatography Publications

The following publications, available in German only, feature Ph Eur monographs for pre-coated TLC plates:

P. Pachaly: "DC-Atlas – Dünnschicht-Chromatographie in der Apotheke", Wissenschaftliche Verlagsgesellschaft Stuttgart 1999, ISBN 3-8047-1623-7. Includes many documented Ph Eur monographs for Merck Millipore TLC plates.

Jürgen Wolf: Mikro-DC, PZ-Schriftenreihe, "Vorschriften auf Basis des Ph Eur, DAB und DAC". Govi-Verlag, Eschborn 1999, ISBN 3-7741-0736-X. This book features a broad range of Ph Eur monographs for Merck Millipore TLC aluminium sheets Si 60.





04

Analytical HPLC



www.merckmillipore.com/analytical-hplc

There's no room for error here. Quality control in the production of pharmaceuticals, chemicals, or food and beverages isn't a plus – it's a must. That's why Merck Millipore offers a comprehensive range of state-of-the-art analytical HPLC solutions, and dedicated application support to help you carefully analyze your products, and protect your customers.

04

Contents

Analytical HPLC	page 146
Method development & optimization	page 148
Pharmacopeial requirements	page 174
Column selection guide	page 188
Chromolith® Speed and performance based on revolutionary monolithic silica technology	page 200
Chromolith® CapRod® Monolithic capillary	page 201
Chromolith® HPLC columns Speed and performance in monolithic form	page 206
Chromolith® RP-18 endcapped Chromolith® RP-18 endcapped columns are the fastest C18 columns in the world.	page 214
Chromolith® RP-8 endcapped	page 230
Chromolith® Phenyl	page 232
Chromolith® CN	page 234
Chromolith® DIOL	page 236
Chromolith® Si	page 238
Chromolith® NH ₂	page 240
Chromolith® guard cartridges and cartridge kits	page 243
Chromolith® column coupler	page 248

Chromolith® SemiPrep Perfect scale-up from analytical to preparative LC	page 250
Chromolith® Prep Chromolith® – increase in speed, efficiency and productivity	page 254
Purospher® The all-round high performance solution for complex HPLC separations	page 262
Purospher® STAR RP-18 endcapped The versatility you need!	page 269
Purospher® STAR RP-8 endcapped Ideal for less hydrophobic compounds	page 283
Purospher® STAR Phenyl Enhanced selectivity for aromatic compounds	page 286
Purospher® STAR Si (Silica) and NH₂ (Amino-phase)	page 289
Purospher® STAR UHPLC columns for ultra fast HPLC Where speed meets performance	page 292
Purospher® STAR columns for LC-MS applications	page 299
Purospher® RP-18 endcapped Excellent peak symmetry with either basic or strongly acidic compounds	page 302
Purospher® RP-18 Polar endcapped column material	page 304
Purospher® RP-18 HC High resolution separation of explosives and related compounds	page 306
Superspher® Silica carrier for highly efficient separations	page 308
Superspher® For highly efficient HPLC of complex mixtures where high peak capacity is required	page 309



04

LiChrospher® Silica carrier for constant top-rate results	page 312
LiChrospher® 100 RP-18 and RP-18 endcapped	page 314
LiChrospher® WP 300 RP-18 High-resolution separations of peptides and tRNA molecules	page 320
LiChrospher® PAH Indispensable in PAH trace analysis	page 322
LiChrospher® 100 RP-8 and RP-8 endcapped For reproducible reversed phase separation	page 325
LiChrospher® 60 RP-select B Excellent separations even with basic compounds	page 329
LiChrospher® 100 CN Excellent for complex samples with polar and hydrophobic characteristics	page 334
LiChrospher® 100 NH ₂ A versatile sorbent for both reversed phase and normal phase chromatography	page 336
LiChrospher® 100 DIOL Excellent for complex samples with polar and hydrophobic characteristics and for exclusion chromatography	page 338
LiChrospher® Si 60 and Si 100	page 340
LiChrosorb® Irregular shaped silica sorbent	page 342
LiChrosorb® A successful packing material from the start	page 343
Aluspher® Alkaline stable HPLC separations	page 345
Aluspher® RP-select B A stable reversed phase stationary phase optimized for applications up to pH 12	page 346

SeQuant® HILIC ZIC®-HILIC, ZIC®-cHILIC and ZIC®-pHILIC are the ideal columns for all classes of polar hydrophilic compounds	page 348
SeQuant® ZIC®-HILIC High-performance columns for hydrophilic compounds	page 354
SeQuant® ZIC®-cHILIC Complementary selectivity for polar hydrophilic compounds	page 359
SeQuant® ZIC®-pHILIC Polymeric columns with extended pH stability for demanding separations of hydrophilic compounds	page 362
Chiral stationary phases Always the proper column for enantiomer analysis	page 363
ChiraDex® Specially for the separation of enantiomers	page 364
Customized packings	page 366
Customized packings Always the right column	page 367
Accessories	page 370
manu-CART® cartridge holder for LiChroCART® cartridges Accessories for particulate HPLC columns	page 370
LiChroCART® cartridge Accessories for particulate HPLC columns	page 373
Hibar® column Accessories for particulate HPLC columns	page 375
LiChroTest® Standard samples for HPLC system qualification	page 378
Column care and use	page 380
Trouble-Shooting	page 388

Analytical HPLC Introduction

Analytical HPLC is routinely used in industry and academia for separation, quantitation and identification of chemical or biological compounds.

Merck Millipore has invested decades into product innovation to ensure the most reliable and reproducible HPLC separations, even for the most challenging analyses. As a result, we offer a comprehensive range of high-quality HPLC columns for use in research, development and quality control, as well as in environmental, clinical and biochemical analyses.

Thanks to their unique, patented, monolithic silica technology, our **Chromolith®** columns allow you to perform ultra-fast and robust separations using standard HPLC systems. For all polar and hydrophilic compounds, the proprietary zwitterionic **SeQuant® ZIC®-HILIC** technology provides straightforward HPLC separations with high flexibility in the selection of separation conditions. The optimally balanced selectivity of **Purospher®** makes it the perfect choice for reversed phase HPLC and UHPLC method development in a wide variety of labs. Merck Millipore's well-established HPLC column brands, **LiChrosorb®**, **LiChrospher®** and **Superspher®**, continue to provide excellent results. In addition, we have developed specialty columns for the separation of chiral compounds, an important application in the pharmaceutical industry.



Analytical HPLC at a glance

Method development & optimization	page 148
Pharmacopeial requirements	page 174
Column selection guide	page 188
Chromolith® Speed and performance based on revolutionary monolithic silica technology	page 200
Purospher® The all-round high performance solution for complex HPLC separations	page 262
Superspher® Silica carrier for highly efficient separations	page 308
LiChrospher® Silica carrier for constant top-rate results	page 312
LiChrosorb® Irregular shaped silica sorbent	page 342
Aluspher® Alkaline stable HPLC separations	page 345
SeQuant® ZIC®-HILIC and ZIC®-pHILIC The ideal columns for all classes of polar and hydrophilic compounds	page 348
Chiral stationary phases Always the proper column for enantiomer analysis	page 363
Customized packings	page 366
Accessories	page 370
Column care and use	page 380
Trouble-Shooting	page 388

Method development & optimization

The overall process is influenced by the nature of the analytes and generally follows the following steps:

- 1 | Selection of the HPLC method and system
- 2 | Establish sample prep procedure
- 3 | Select the detector
- 4 | Selection of initial conditions
- 5 | Mobile phase selection
- 6 | Selectivity optimization
- 7 | System optimization
- 8 | Method validation
- 9 | Scaling of HPLC methods

1 Selection of the HPLC method and system

Method development is not difficult when a literature reference can be found to same or similar needs. Methods are published in pharmacopeia, in column manufacturer application databases and as published scientific studies. This can provide good guidance for the planned work, but what happens when references to the compounds of interest do not exist?

Different approaches are possible, and trial and error is the least successful way forward. A chromatographer normally has access to a wide variety of equipment, columns, mobile phase compositions and operational parameters which make high performance liquid chromatography (HPLC) method development seem complex. In this chapter direction will be given to make your method development intuitive and successful, with emphasis on column selection.

Method goals

Method development is to define needs, set goals, and make experimental plans, then to carry out the practical work and finally validate and put the new method into routine work. For these reasons, method development should be started at the desk, and not in the laboratory. A number of questions should be addressed and answered.

- Is the primary goal quantitative or qualitative analysis?
- If quantitative analysis is requested what levels of accuracy and precision are required?
- Are standards available?
- Do we need to perform detection of one or many analytes?
- Is it necessary to resolve all sample components?
- How many different sample matrices is the method designed for?
- How many samples will be analyzed at one time?
- If qualitative analysis is requested it is important to define whether the method will be used for characterization of unknown sample components or isolation/purification of analytes

These initial questions will direct the chromatographers to define the method goal, and to find out requirements of the new method.

Do you really need high resolution (in separation and detection), short analysis time, maximum sensitivity, long column lifetime, a column with wide pH stability or will the method be used at neutral pH and under non-aggressive conditions. True optimization of a method is a balance between selectivity, speed and efficiency, in order to produce resolution that fits the purpose of the application. Ideally, the development should result in a robust method that gives the laboratory a low overall price-per-injection and ultimately a cost-efficient assay.

Common mistakes in analytical method development

- Inadequate formulation of method goals
- Insufficient knowledge of chemistry
- Use of the first reversed phase HPLC column available
- Use of wrong instrument set-up
- Trial and error with different columns, mobile phases

These mistakes often results in laborious, time consuming projects that lead to methods which fail to meet the needs of the laboratory.

Getting started

After defining the goal of the method development, specific information of the sample and the analytes should be sought. Different sources are available: e.g. scientific journals, chemical databases like www.pubmed.org (small molecules) ExPASy Proteomics Server <http://expasy.org> (large biomolecules) and reference books. Listed below are some of the most common parameters.

- Nature of the sample
- Number of compounds/analytes present
- Chemical structure (functionality)
- Molecular weight of the compounds
- pKa values
- log P and/or log D values (hydrophilicity/hydrophobicity)
- Concentration
- Sample matrix
- Sample solubility

Depending on the method requirements, some steps will not be necessary. For example, if a satisfactory separation is found initially, steps 6 and 7 may be omitted. The extent to which method validation (step 8) is investigated and pursued will depend on the final use of the analysis; for example, a method required for quality control will require more validation than one developed for a one-off analysis.

Method development & optimization

- 1 | Selection of the HPLC method and system
- 2 | Establish sample prep procedure
- 3 | Select the detector
- 4 | Selection of initial conditions
- 5 | Mobile phase selection
- 6 | Selectivity optimization
- 7 | System optimization
- 8 | Method validation
- 9 | Scaling of HPLC methods

2 Establish sample prep procedure

Consideration must be given to sample preparation. Does the sample require dissolution, filtration, preconcentration or clean up? Is it possible or needed to use solid phase or liquid-liquid extraction procedures, column switching or any other automated on-line techniques? In the following sections, emphasis will be focussed to reversed phase method development. Guidance will be given also to the other modes of liquid chromatography, for which more information can be found at www.merckmillipore.com/chromatography.

Finally, remember to keep it simple, and think of factors that are likely to be significant in achieving the desired resolution.

What to do and where to start?

Think about the sample as being the central part during all steps, as illustrated in figure, since HPLC method development should aim at separating analytes from a defined matrix, and at allowing detection with sufficient sensitivity in a rugged and easy way for the analyst.

What to do and where to start?

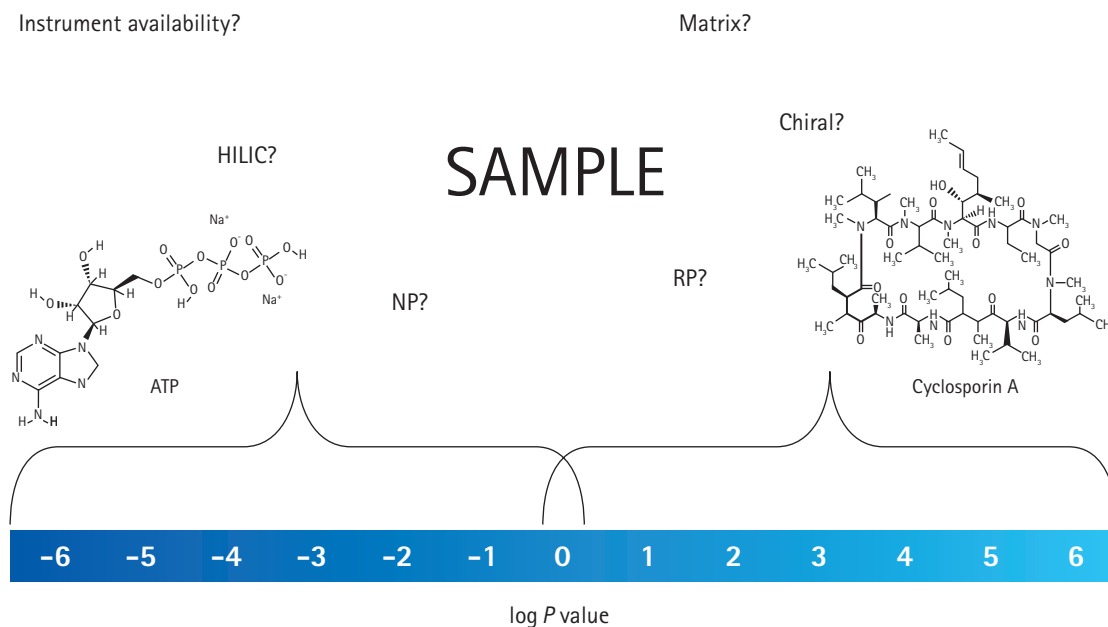

More useful and detailed information can be found in the column selection guide on page 188.

Select the detector

3

To select the most appropriate detection mode, four important parameters should be taken into consideration; chemical nature of the analytes, potential interferences, limit of detection (LOD) and limit of quantitation (LOQ) required, linearity range, availability and/or cost of detector. Below are some of the most common detection techniques for liquid chromatography presented. Fluorescence, electrochemical or mass detectors should be used for trace analysis. For preparative HPLC, refractive index is preferred because it can handle high concentrations without overloading the detector.

Ultraviolet/Visible absorbance (UV/Vis)

UV detectors are most commonly used. It is a robust, inexpensive and versatile detection technique since most compounds absorb light, especially at low UV wavelengths. It is possible to use a Diode Array Detector (DAD) and allow monitoring at multiple wavelengths simultaneously. The downside is that a UV detector is not analyte specific and requires that the analyte absorb more light than sample matrix at the set wavelength. Choose a detection wavelength that maximizes sensitivity and specificity, but keep in mind that the mobile phase solvents and buffer components may cause slight shifts in UVmax from reference values. Therefore it is advisable to check the analyte absorbance in the mobile phase. Mobile phase solvents and buffer components also have UV cut-off, and make sure to work well above these levels. Otherwise there are likely to be problems with reduced sensitivity and increased system noise (unstable and drifting baseline noise). UV wavelengths below 200 nm should be avoided because detector noise increases in this region. Higher wavelengths give greater selectivity.

Refractive index (RI)

Refractive index is also a common detection technique, and measures the difference in the refractive index of a sample cell versus a reference cell. It is also a non-selective detection technique, being concentration dependent and where the sensitivity is typically 100-1000 times lower than a UV/Vis detector. The benefit over a UV detector is the possibility to quantify analytes with no chromophores in the molecular backbone. The drawback is the sensitivity and the fact that RI detectors can only be used in isocratic mode. It is possible to use with gradients but requires special modifications which makes it less user friendly.

Fluorescence (FL)

Fluorescence detection is very specific and measures only compounds that fluoresce, hence a requirement of this technique. The operation is similar to a UV/Vis detector but where the detector flow cell is used as the sensor through which excitation light passes axially. A photocell is located at the side of the cell to receive radially emitted light. The cell wall is made of special glass to prevent the excitation light or other stray light from reaching the photo cell. When a solute that fluoresces in the excitation light flows through the cell, the molecule excites and fluorescent light passes through the walls of the cell onto the photo cell. The excitation light may be light of any wavelength selected from the light source using a monochromator. Another monochromator may also be used to selectively analyze the fluorescent light and, thus a fluorescent spectrum can be produced for excitation light of any specific wavelength and an excitation spectrum produced for fluorescent light of any specific wavelength. To improve specificity of an LC analysis, a fluorescent derivatization reagent can be added (either pre-column or post-column) to form a fluorescent derivative of the substance of interest. This derivative may then be selectively detected from other solutes which, (if they do not fluoresce) need not be resolved from each other by the separation column. Fluorescence detection is up to 1000 times more sensitive than UV/Vis, and also concentration sensitive.

Method development & optimization

Select the detector

Evaporative light scattering (ELS or ELSD)

ELSD is also a non-selective detection technique, but where the detector is mass sensitive and not concentration dependent. It is an ideal technique for high molecular weight compounds, sugars and less volatile acids. The detector measures the light scattering and where the amount of scattering is related to the molecular mass of the analyte, i.e. the more mass the more scattering will be seen measured. In the detector there are three processes; nebulization of the mobile phase (1), evaporation of the mobile phase (2) and light scattering by analyte particles. In contrast to RI, it works well in gradient mode. Keep in mind that mobile phase solvents should be volatile for best performance.

Electrochemical (EC)

An electrochemical detector requires that the analytes can be oxidized or reduced by an electrical current. The detector output is an electron flow generated by a reaction that takes place at the surface of electrodes. If this reaction is complete (exhausting all the analyte) the current becomes zero and the generated total charge is proportional to total mass of material that has been reacted. This process is called coulometric detection. If the mobile phase is continuously flowing past the electrodes, the reacting analyte is continuously replaced in the detector. As long as the analyte is present between the electrodes, a current will be maintained, albeit varying in magnitude, and is called amperometric detection. An electrochemical detector requires three electrodes, the working electrode (where oxidation or reduction takes place), the auxiliary electrode and the reference electrode (compensates for changes in the background conductivity of the mobile phase). Electrochemical detection is more sensitive than fluorescence detection, very sensitive but commonly not as selective as fluorescence and generally not compatible with gradient elution.

Mass spectrometer (MS)

Mass spectrometry is today regarded as an established routine detection technique. MS detectors can be coupled to various separation techniques such as liquid chromatography (LC), thin layer chromatography (TLC), or gas chromatography (GC) where the hyphenation with LC is by far the most frequent setup. In contrast to more simple detectors, i.e. UV, RI, FL etc, MS generates data about molecular masses and detailed structural parameters and thereby offers the possibility to discriminate between co-eluting peaks in selected ion monitoring mode. The latter reduces the requirement for chromatographic retention and resolution before detection, yet it is always better to have retained and completely resolved peaks to prevent ion suppression or ion enhancement effects.

Mass analyzers can be quadrupole, magnetic sector, time-of-flight, ion trap or ion cyclotron resonance type. A quadrupole mass analyser consists of four parallel rods that have fixed DC and alternating RF potentials applied to them. The HPLC system handles dissolved analytes under ambient pressure (760 Torr) and delivers the sample to the MS, where the detection of the gaseous, ionized samples is performed under high vacuum conditions (10⁻⁵–10⁻⁶ Torr). The transfer of the analyte solution from the LC to the MS is accomplished via an interface. The interface stepwise converts the sample to an aerosol, ionizes it and removes the solvent. Ions are then focussed and passed along the middle of the quadrupoles. Their movement will depend on the electric fields so that only ions of a particular mass to charge ratio (m/z) will have a stable path to the detector. The RF is varied to bring ions of different m/z into focus on the detector and thus build up a mass spectrum. Depending on the physical properties and the molecular mass of the molecules different types of interfaces are used, where they vary among each other in how they ionize the molecules and the pressure applied during this process. At present all the common ionization techniques operate under ambient pressure; i.e. electrospray ionization (ESI), atmospheric pressure chemical ionization (APCI), matrix assisted laser desorption/ionization (MALDI) and the less prominent atmospheric pressure photo ionization (APPI). ESI and APCI are by far the most widely used in LC-MS hyphenation. The more esoteric techniques, electron ionization (EI) and chemical ionization (CI) work under high vacuum conditions with the advantage of being suitable for GC-MS hyphenation. Quadrupole mass spectrometers commonly have two configurations when used with liquid-chromatography, either as a simple single quadrupole system or placed in tandem. The latter principle, the triple quadrupole mass spectrometer, enables ion fragmentation studies (tandem mass spectrometry or MS/MS) to be performed.

Electrospray Ionization (ESI)

In ESI mode liquid solutions of charged or polar substances, delivered with a HPLC system, are sprayed utilizing a metal capillary ("spray needle") and a nebulizer gas (nitrogen) in the MS. Resulting droplets are dried (desolvatization) and volatilized isolated analyte ions are transferred to the detector. Thermal stress is very low hence the analyte molecules do not decompose. ESI is almost unlimited regarding molecule size and suitable for medium to strong polar molecules, e.g., amines, carboxylic acids, heteroaromatics, and sulfonic acids. ESI is applied when fragmentations are unwanted and molecular masses of biomolecules have to be determined. ESI-MS is well suited for hyphenation with LC, and as long as flow rates do not exceed maximum 1–2 mL/min attainable sensitivity is very high, however more common is flow rates between 1–500 $\mu\text{L}/\text{min}$. In liquid solution molecules are either already ionized or becomes protonated or deprotonated by additives in the sample solution and the mobile phase. To achieve best sensitivity, mobile phases used should be set at a pH where analytes are ionized, and a rule of thumb is to use neutral to basic pH (7–9) for acids whereas more acidic pH (3–4) is advisable for basic compounds. If the analytes of interest have multiple pKa values and may change their ionization state, other pH values may be more beneficial both in terms of ionization of the analyte and behavior in the column. Thus depending on the choice of solvent and additives either positive and/or negative ESI mode can be used. Typically, positive mode is applied in combination with more basic molecules, while acid compounds are analyzed in negative mode. 0.1 % formic acid is commonly added to the mobile phase in positive ESI mode to provide a low pH (≈ 3) to protonate the analytes(s). Acidic analytes will be neutralized under such conditions wherefore negative ESI mode is preferred and higher mobile phase pH is recommended. Volatile buffers like ammonium acetate or ammonium formate are used in the pH range 4.5–7 to deprotonate the analyte(s), and for high pH it possible to use either ammonium carbonate or ammonium hydroxide (aqueous ammonia). For both negative and positive ESI it is a prerequisite that all solvents and additives are volatile in order to avoid contamination of the mass spectrometer and that the total mobile phase ionic strength is adequate (generally 2–25 mM) to prevent unnecessary down-time for cleaning of detector. Strong acids like hydrochloric acid or nitric acid are unsuitable for two reasons: They form ion pairs with analyte molecules (analyte signal suppression) and display strong oxidizing properties. Trifluoroacetic acid (TFA) is a special case: It is widely used as an ion pairing reagent to improve the liquid chromatographic separation of peptides or proteins. On the other hand, TFA can cause strong ion suppression in mass spectrometry (mainly in negative ESI mode) and also contaminates the LC-MS system. Unfortunately both a quantitative estimation of these effects as well as general recommendations is not possible, as their strength strongly depend on the MS system used. Triethylamine as an alternative additive behaves in a similar manner. If the use of TFA is unavoidable, a weak acid (such as propanoic acid) or isopropanol can be added to the eluent to decrease a signal suppression effect.

Buffers do not only adjust the pH of the eluent and lead to ionization of a target molecule; they can also form adducts with the analyte. Adducts $[\text{M}+\text{buffer}]$, e.g. with ammonium, alkali, halogens, formate or acetate, will lead to the detection of an additional peak in the MS spectrum; even a complete suppression of the analyte signal is possible when the vapor pressure of the resulting adduct (mainly alkali) is decreased significantly. As a reason of this and in order to keep the ESI source clean, volatile buffers are recommended. Non-volatile salts like phosphates, borates, sulfates or citrates will precipitate in the MS source, block it and cause tedious cleaning procedures!

Method development & optimization

Select the detector

Atmospheric pressure chemical ionization (APCI)

This technique is complementary to ESI and also useful for LC-MS hyphenation. It does not require a mobile phase with conducting properties wherefore acetone or acetic acid esters can be used as solvents and thus allows for a coupling of APCI with normal phase chromatography. In APCI mode, the analyte solution is vaporized prior to the ionization. Subsequently solvent molecules (aqueous-organic, e.g. methanol, propanol, acetonitrile, acetone etc., combined with 2-20 mM of a volatile organic buffer such as formic or acetic acid, ammonium acetate, ammonium formate or triethylamine) become ionized with a corona needle where their charge is then transferred to the analyte molecules via proton transfer or abstraction. APCI is suitable for the analysis of less polar, weakly ionizable substances with small or medium molecular weight (analytes without acidic or basic functional groups, e.g. hydrocarbons, alcohols, aldehydes, ketones, esters) and therefore complementary to ESI, as long as the sample is thermally stable and vaporizable.

Fragmentations are generally observed with APCI. Highest sensitivity is achieved with acetonitrile, methanol or water as solvents, and where the degree of analyte ionization can be optimized via eluent pH. As for ESI flow rates up to maximum 1-2 mL/min can be tolerated.

There are other less commonly used detection techniques possible to combine with liquid chromatography, such as chemiluminescence nitrogen (CLND), radio detectors, charged aerosol (CAD), inductive coupled plasma (ICP), NMR, but these are not dealt with here.

Selection of initial conditions – mode of separation, column and mobile phase

4

When selecting the most suitable mode of separation, it is dependent on sample solubility and how the analytes of interest differ from other compounds or matrix in the sample. In reversed phase (RP) mode the mobile phase is polar and the stationary phase is less polar. The major distinction between analytes is their hydrophobicity where samples should be soluble in water or a polar organic solvent. In normal phase (NP), the mobile phase is non-polar while the stationary phase is more polar. This is the same for hydrophilic interaction liquid chromatography (HILIC). In normal phase, the major distinction between analytes is NOT their hydrophobicity, and where the samples should be soluble in a hydrophobic solvent like hexane and the mobile phase is a weak to moderate solvent for the sample.

In HILIC mode, the mobile phases are the same as for reversed phase, but with the opposite elution strength. The major distinction between analytes is their hydrophilicity and the sample should be soluble in a polar organic solvent or organic solvent – water mixtures. For polar and hydrophilic compounds the traditional approach utilized reversed phase ion-pairing and was used for analytes which were ionic or potentially ionic. In this situation the mobile phase contains a buffer, an ion-pair reagent and a polar organic solvent. Typical ion-pair reagents are; alkyl sulfonates (heptane sulfonic acid, octane sulfonic acid) and used for bases; and where quaternary amines (tetrabutylammonium chloride) are used for acids. Today, reversed phase ion-pairing methods can easily be replaced with HILIC with the benefit of having more robust and sensitive methods without the need of using ion-pairing reagent.

Choose the right HPLC column

Chromatographic resolution is mainly affected by the selectivity (α), as can be seen in the figure below. Changing the mobile phase composition or the stationary phase, is the most powerful way of optimizing selectivity whereas the particle size, pore size, length of the column, temperature, mobile phase strength have much less effect. Therefore, if satisfactorily results are not met, or no retention is achieved, it is better to change to another selectivity using a different column type and/or a different mobile phase.

Resolution is mainly controlled by selectivity

Resolution (R_s or R) can be expressed in terms of three parameters (k , α , and N) which are directly related to experimental conditions.

k is the average retention factor for the two bands,
 N is the column plate number and
 α is the separation factor (or selectivity factor).

The parameters k and α is determined by the experimental conditions (composition of the mobile phase; stationary phase chemistry and temperature), and where N is affected by column length, particle size and pore size.

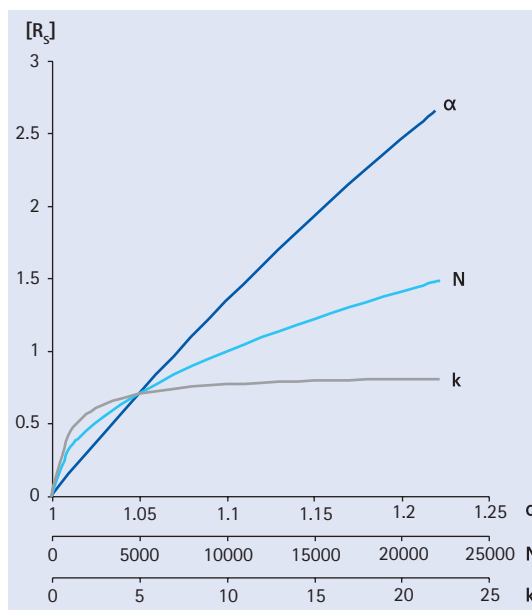

Method development & optimization

Selection of initial conditions

Stationary phase selection

After setting the method goals and careful investigation of the analyte structures (hydrophobicity/hydrophilicity; functional groups and potential detection possibilities), select a few bonded phases fitted for its purpose along with a viable detector. The initial column selection is very important and the chromatographer should be advised not to use the first reversed phase HPLC column available. Reversed phase liquid chromatography is indeed a workhorse in most laboratories, and a particulate RP-18 column is often the first choice for many chromatographers, but many methods are unfortunately developed not utilising best or most appropriate selectivity. If the sample is mainly of hydrophobic character, having positive log *P* values and mainly having hydrophobic functional groups, a reversed phase column is advisable. Select a C18 or C8 bonded phase for good retention and resolution. If the sample molecules have aromatic backbones and where C18 or C8 columns are unable to resolve all components, then change to a phenyl column where, in addition to hydrophobicity, π - π interactions between the stationary phase and sample molecules provide a different selectivity. It is, however, important to use alcohols as the mobile phase organic modifier while working with phenyl columns. Acetonitrile or any solvent with double or triple bonds (π - π bonds) in the backbone will diminish the interaction and make the phenyl column interact only with hydrophobicity. If the method is intended for bioanalysis, analysis of dirty samples in general, or where proper sample preparation is unwanted/not possible, a monolithic reversed phase column (e.g. Chromolith®) is a superior choice over a particulate column. Chromolith® RP-18e is a better choice over Purospher® STAR RP-18e for such purposes as it has very good matrix tolerability and long column lifetime.

If samples are clean or and/or good sample preparation will be included in the final method, and very high peak capacity is needed, a particulate column with small particles and small pores may be more useful. Choose also columns known to have long lifetime at operating mobile phase pH. Choose bonded phases based on high purity, low acidity silica for best peak shape. If the sample is consisting of polar and hydrophilic analytes an orthogonal selectivity to reversed phase should be selected. If chiral resolution is defined in the method goal, a suitable chiral column should be chosen etc. Use analyte specific structure information (chemical structure, log *P* values etc) to choose a proper stationary phase. If acidic or basic analytes are present in the sample; reversed phase ion suppression (for weak acids or bases), reversed phase ion-pairing (for strong acids or bases) or HILIC should be used. For low/medium polarity analytes, normal phase HPLC or HILIC are viable techniques, while HILIC, and particularly ZIC®-HILIC is the most suitable separation technique for polar and hydrophilic compounds.

Polarity scale of analyte functional groups

Polarity	Functional group	Hybridization	Intermolecular forces
Low	Methylene	s	London
	Phenyl	s / p	London
	Halide	s	London, Dipole-Dipole
	Ether	s	London, Dipole-Dipole, H-bonding
	Nitro	s / p	London, Dipole-Dipole, H-bonding
	Ester	s / p	London, Dipole-Dipole, H-bonding
	Aldehyde	s / p	London, Dipole-Dipole, H-bonding
	Ketone	s / p	London, Dipole-Dipole, H-bonding
	Amino	s / p	London, Dipole-Dipole, H-bonding, Acid-base chemistry
	Hydroxyl	s	London, Dipole-Dipole, H-bonding
High	Carboxylic acid	s / p	London, Dipole-Dipole, H-bonding, Acid-base chemistry

Choosing the right column format

Use the column selection guide to find the best column configuration for minimum analysis time with high efficiency and resolution, and match up method goals to make sure that the chosen format has the ability to produce resolution that fits the purpose of the application, e.g. choose right column length, column inner diameter, particle size and pore size. If you need high mass loadability, a larger column (both in length and diameter) is recommended as it can accommodate more mass. If you work with traditional detectors like UV, RI, FL etc 4.6 or 3.0 mm i.d. columns are suitable but for MS generally a 2 mm or smaller i.d. column is recommended. If you have sufficient resolution, it is also possible to speed up the separation by increasing the flow rate or shorten the column length. Silica-based materials are physically strong and will not shrink or swell, being compatible with a broad range of polar and non-polar solvents, and therefore often the initial choice. Most silica based columns are stable from pH 2–7.5, and historically, polymeric packing materials provided better column stability under pH extremes. A polymer-based packing material, like ZIC®-pHILIC, is compressible and may shrink or swell with certain solvents. Therefore care must be taken if a polymeric column is used, and the upper back-pressure limit is lower than corresponding silica based stationary phases. Newer high-purity silica based phases, like Purospher® STAR, are stable at pH 1.5–10.5, with the surface functional groups bound to the base silica particle at multiple attachment points via polymeric modification.

Particle size

Smaller particle sizes provide higher separation efficiency and higher chromatographic resolution than larger particle sizes. However, larger particle sizes offer faster flow rates at lower column back-pressure, and are less prone to clogging, and for these reasons are more tolerant to matrix effects. Typical particle sizes range from 3–20 µm, but new 2 µm particle sizes are available to maximize resolution on short Purospher® STAR columns. A 5 µm particle size represents the best compromise between efficiency and back-pressure for most non-high throughput applications.

Pore size

Choose a pore large enough to completely enclose your target molecule. If your molecule is larger than the pore, size exclusion effects will be seen and it will be difficult or impossible to retain. In general, packing materials with a smaller pore size have higher surface areas and higher capacities than packing materials with larger pore sizes. A larger surface area typically indicates a greater number of pores, and therefore a higher overall capacity. Smaller surface areas equilibrate faster, which is important for gradient elution analyses. Larger pores are better for interaction with large compounds, such as proteins.

Carbon load

For silica-based reversed-phase packing materials, carbon load indicates the amount of functional bonded phase attached to the base material. Phases with lower carbon loads are more weakly hydrophobic, which may significantly reduce retention times over phases with higher carbon loads. However, a higher carbon load will give higher capacity and often greater resolution, especially for compounds of similar hydrophobicity. Carbon load is not a relevant parameter for columns used in normal phase or HILIC mode.

Endcapping

Silica-based reversed-phase packing materials have free silanol groups that will interact with polar compounds. Endcapping the bonded phase minimizes these secondary interactions. Choose endcapped phases if you do not want interactions with polar compounds. Choose non-endcapped phases if you want enhanced polar selectivity, for stronger retention of polar organic compounds.

Method development & optimization

- 1 | Selection of the HPLC method and system
- 2 | Establish sample prep procedure
- 3 | Select the detector
- 4 | Selection of initial conditions
- 5 | Mobile phase selection**
- 6 | Selectivity optimization
- 7 | System optimization
- 8 | Method validation
- 9 | Scaling of HPLC methods

5 Mobile phase selection – solvents and buffers

In a previous chapter, insight has been given to mobile phase recommendations, solvent properties and buffer components. Herein, a summary of starting conditions are presented along with a discussion about the difference among isocratic and gradient elution. The mobile phase solvent strength is a measure of its ability to elute analytes of the column. It is generally controlled by the concentration of the solvent with the highest strength; for example, in reverse phase HPLC with aqueous mobile phases, the strong solvent would be the organic modifier; in normal phase and HILIC, it would be the most polar one. Worth pointing out is that cyano-bonded phases are easier to work with than plain silica for normal phase separations. The aim is to find the correct concentration of the strong solvent. With many samples, there will be a range of solvent strengths that can be used within the aforesaid capacity limits. Other factors (such as pH) may also affect the overall retention of analytes.

Isocratic elution

In partition chromatography, the mobile phase should be a moderate to weak solvent for the samples to achieve peak focusing and not to compromise the actual separation. A good rule of thumb is to achieve a capacity factor (retention factor, k) of 2 to 5 for an isocratic method. In both RP and HILIC mode, the preferred organic solvent is acetonitrile for several reasons; favourable UV transmittance, low viscosity, and being easy to volatilize (important for MS, ELSD and corona discharge, CAD, detectors). Methanol is a reasonable alternative, hence it may be worth changing the organic solvent if resolution is not achieved and adjust the percentage organic solvent in the mobile phase to accomplish maximum resolution and retention. Methanol and other alcohols are also preferred choice as the mobile phase organic modifier while working with phenyl columns. Acetonitrile or any solvent with double or triple bonds in the backbone will diminish the π - π interaction and make the phenyl column interact only with hydrophobicity.

In reversed phase mode, the initial mobile phase pH should be selected with two considerations. Low pH that protonates column silanol groups and reduce their chromatographic activity is generally preferred, especially with non-encapped columns. Mobile phases having pH 1 to 3 with 20-50 mM buffer (Potassium Dihydrogen Phosphate, TFA or formic acid in water) is advisable depending on detection mode, and to increase temperature to reduce analysis time. Mobile phase solvents should be water miscible, have low viscosity, low UV cut-off, being non-reactive, and for these reasons acetonitrile, methanol and tetrahydrofuran (THF) are used with RP columns. Not all RP methods are suitable under acidic conditions, and other pH intervals may provide different selectivity. At mid pH, dipotassium hydrogen phosphate or ammonium acetate (not a true buffer, but rather a pH adjustable salt) are viable alternatives depending on detection mode. At high pH, dipotassium hydrogen phosphate and ammonium carbonate can be used as buffers to maintain pH above 8. Keep in mind that working at high pH, only columns with wider pH tolerability should be used, and for this purpose Purospher® STAR is an excellent choice. Inorganic buffers are not recommended with MS, ELSD and CAD detectors. They are not volatile and may precipitate, and this is also the case when high percentages of solvent are used in the mobile phase (>70 %).

Gradient elution

Often it is not possible to elute all analytes with a single mobile phase (isocratic) in the desired k' (2–5) range. It is therefore advisable to use gradient elution where the mobile phase strength, and sometime also pH and ionic strength, changes over time. Effectively this means that early in the gradient the mobile phase elution strength is low, and where the elution strength is increasing with time according to a defined program that maximises the number of peaks that can be resolved with a given resolution. This results in of the constant peak width observed in gradient elution, compared to isocratic elution where the peak width increases in proportion to retention time. Gradient elution is used to solve the general elution problem for samples containing mixtures of analytes with a wide range of polarities. Gradient elution will also give greater sensitivity, particularly for analytes with longer retention times, because of the more constant peak width (for a given peak area, peak height is inversely proportional to peak width). Common practice in method development is to run a broad gradient first to decide whether to use isocratic or gradient elution.

If $\Delta t/tG \geq 0.25$ use **gradient elution** If $\Delta t/tG \leq 0.25$ use **isocratic elution**

Where Δt is difference in the retention time between the first peak and last peak in the chromatogram, tG is the gradient time; the time over which the solvent composition is changed. For most samples (unless they are extremely complex), short columns (10–15 cm) are recommended to reduce method development time. Such columns afford shorter retention and equilibration times. A flow rate of 1–1.5 mL/min should be used initially.

Gradient method development

Good laboratory practice is to not allow gradients going from 100 % aqueous to 100 % organic. For method ruggedness reasons (to get better mixing, to prevent precipitation of salt and to provide more robust gradient profiles) it is advisable to keep minimum 5 % of each phase in both mobile phase bottles. In practice for a reversed phase method, this means mobile phase A contains 5 % organic solvent and 95 % aqueous, while mobile phase B contains 95 % organic solvent and 5 % aqueous.

It is advisable to initially run a wide scouting gradient (0 – 100 % B) over 40–60 minutes. From this run decide whether isocratic or gradient elution is best for the application. If gradient mode is a more appropriate alternative, eliminate sections of the gradient and try to compress the analyte peaks in space as much as possible prior to the first and last eluting peak. To further improve the gradient profile and to shorten overall cycle times (including re-equilibration) try to reduce the gradient and total run time. Keep in mind that a segmented gradient can be an effective tool to improve the separation. Seldom is a linear gradient the best solution. If there is a need to improve the separation of two closely eluting peaks; change the solvent strength by varying the fraction of each solvent (gradient shape and steepness); change column temperature; change the mobile phase pH (in small units); use different mobile phase solvents and/or buffer components; and/or use a different selectivity by changing the stationary phase.

Method development & optimization

- 1 | Selection of the HPLC method and system
- 2 | Establish sample prep procedure
- 3 | Select the detector
- 4 | Selection of initial conditions
- 5 | Mobile phase selection
- 6 | Selectivity optimization**
- 7 | System optimization
- 8 | Method validation
- 9 | Scaling of HPLC methods

6 Selectivity optimization

In HILIC mode, gradient elution is accomplished by increasing the polarity of the mobile phase, by decreasing the concentration of organic solvent, i.e. in the "opposite" direction compared to RPLC separations. With charged HILIC stationary phases, like ZIC®-HILIC there is also a possibility of increasing the salt or buffer concentration during a gradient to disrupt electrostatic interactions with the solute. After a gradient run the column has to be equilibrated with the starting concentration of the mobile phase before the next sample can be injected. It must be emphasized that HILIC stationary phases are less tolerant to fast gradients and short equilibrium times compared to RPLC phases. This is because the water in the aqueous layer within the stationary phase originates from the eluent and therefore is depending on its composition.

It is also worth mentioning that the column back-pressure will increase during the gradient. Failure to properly equilibrate columns will cause drifting retention times and poor reproducibility. In some cases, however, it is possible to reach a dynamic equilibrium with stable retention times if fast gradients are run repeatedly for a longer period of time, but this situation can be tricky to obtain and reproduce.

The direct disadvantages with gradient elution are the need of a more complex HPLC system, and the separation column requires re-equilibration after every analysis which makes injection-to-injection lengthier than for an isocratic method. It is not compatible with all detectors (i.e. RI and EC), more variables to control for reproducibility and system dwell volume (gradient delay volume) becomes important especially in scaling a separation or whenever transferring a method between instruments and/or laboratories. Therefore be aware that delay volumes will vary from instrument to instrument. In certain applications, flow-gradients can be a better and simpler approach than solvent gradient elution for shortening analysis time, and compressing eluting peaks. If the column provides low back-pressure, as with Chromolith® columns or when working with HILIC columns, it is possible to change the flow rate during analysis, linearly or stepwise. Less complicated HPLC system is required, and the re-equilibration is much quicker, normally 30–60 seconds is enough between injections.

System optimization

7

To find the desired balance between resolution and analysis time after satisfactory selectivity has been achieved, parameters such as column dimension, particle size and flow rate should be optimized. With a truly scalable stationary phase, these parameters may be changed without affecting capacity factors or selectivity. With the introduction of smaller particle sizes and narrower column inner diameters, also optimization of the complete HPLC instrumentation is needed, and sometimes it is necessary to replace the whole system. An example of a successful complete system optimization is shown for Pantoprazole sodium (Pantoloc, Protium, Pantecta and Protonix; a proton pump inhibitor drug that inhibits gastric acid secretion).

The chemical structure of Pantoprazole sodium

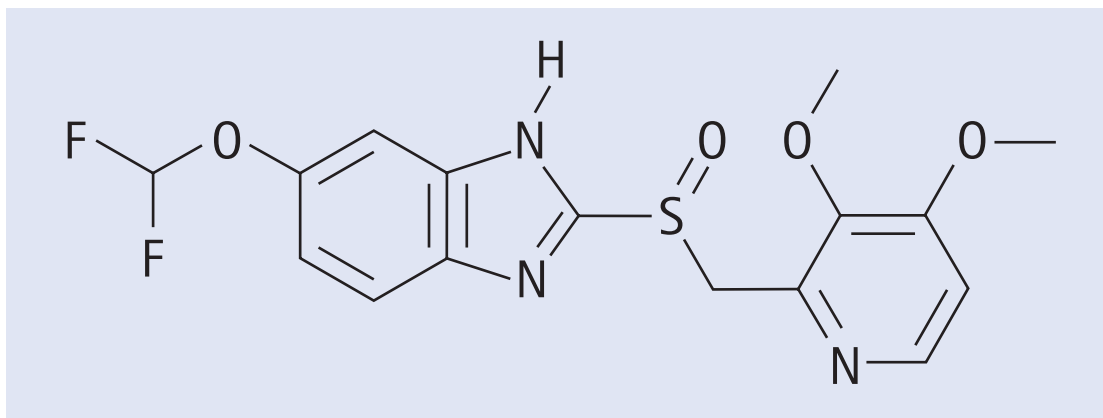

The original method was developed on a Purospher® STAR RP-18 endcapped 150 x 4.6 mm column with 5 µm particles with a total cycle time of 50 minutes. By changing to a Purospher® STAR RP-18 endcapped 50 x 2.1 mm column with 2 µm particles, lowering the flow-rate, and altering the gradient profile, it was possible to reduce the total analysis time from 50 to 5 minutes, maintaining sample peak profile (with improved resolution), at low back-pressure and high separation efficiency.

Method development & optimization

System optimization

Chromatogram showing the purity profile of Pantoprazole sodium on a Purospher® STAR RP-18 endcapped 150 x 4.6 mm column with 5 µm particles

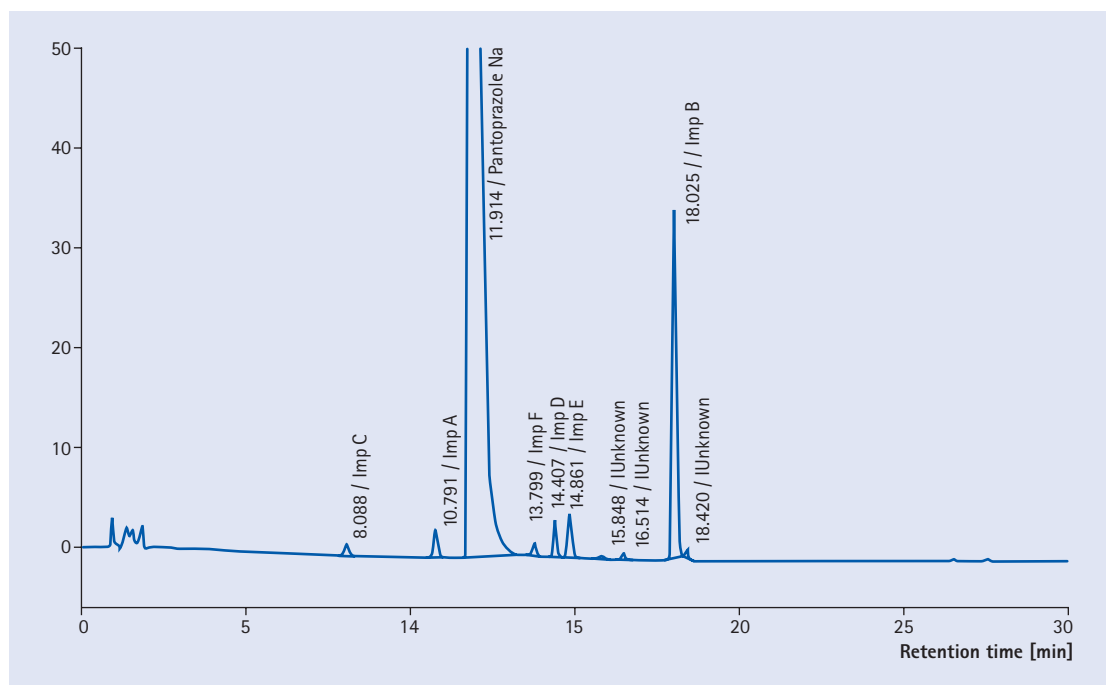

Column	Purospher® STAR RP-18 endcapped 150 x 4.6 mm, 5 µm
Mobile phase	A: 1.74 gram dipotassium hydrogen phosphate in 1000 mL water, adjusted pH to 7.0 with dilute phosphoric acid (330 gm/L) B: Acetonitrile
Gradient	initial composition 80 % A and 20 % B linear increase to 20 % A and 80 % B in 40 min followed by a 10 min re-equilibrium at initial composition
Flow rate	1 mL/min
Detection	UV 290 nm
Column temperature	40°C
Injection volume	20 µL
Sample	460 ppm in 1:1 mixture of ACN and 0.001 N NaOH

Chromatogram showing the purity profile of Pantoprazole sodium on a Purospher® STAR RP-18 endcapped 50 x 2.1 mm column with 2 µm particles

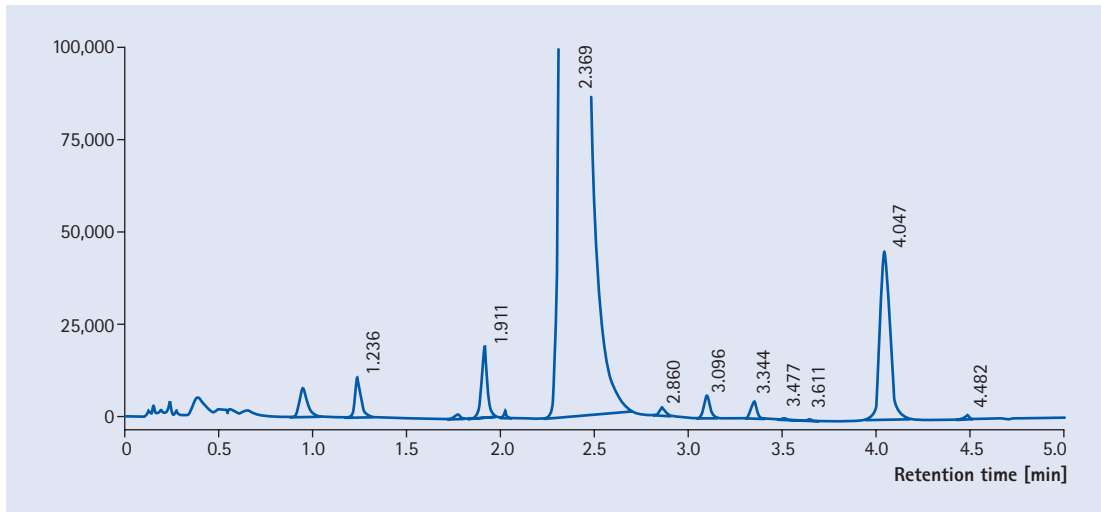

Column	Purospher® STAR RP-18 endcapped 50 x 2.1 mm, 2 µm
Mobile phase	A: 1.74 gram dipotassium hydrogen phosphate in 1000 mL water, adjusted pH to 7.0 with dilute phosphoric acid (330 gm/L) B: Acetonitrile
Gradient	initial composition 80 % A and 20 % B linear increase to 28 % B in 1.5 min followed by an increase from 28 to 40 % B between 1.5 and 4.0 min finally a re-equilibrium at initial composition for 1 min
Flow rate	0.6 mL/min
Detection	UV 290 nm
Column temperature	40°C
Injection volume	7 µL
Sample	460 ppm in 1:1 mixture of ACN and 0.001 N NaOH

Method development & optimization

- 1 | Selection of the HPLC method and system
- 2 | Establish sample prep procedure
- 3 | Select the detector
- 4 | Selection of initial conditions
- 5 | Mobile phase selection
- 6 | Selectivity optimization
- 7 | System optimization
- 8 | Method validation**
- 9 | Scaling of HPLC methods

8 Method validation

Proper validation of an analytical method is important to ensure that it will provide similar results, today-tomorrow-next week-next year, i.e. over a long period of time, in different laboratories independent of the analyst. Not only because of requirements from regulatory authorities, but rather to ensure good manufacturing practice (GMP) and good laboratory practice (GLP). It is especially important for pharmaceutical analysis when assurance of the continuing efficacy and safety of each batch manufactured relies solely on the determination of quality. Guidelines for the validation of analytical methods can be found at the International Council on Harmonization (ICH). The US Food and Drug Administration (FDA) and US Pharmacopeia (USP) both refer to ICH guidelines.

Keep in mind that analytical method validation should be isolated from the initial selection and development, which actually are only the first steps in establishing a routine analytical method. Validation means testing of the method to find out allowed variability for each method parameter. Routine quality control methods should guarantee that the analytical results of raw materials, excipients, intermediates, bulk products or finished products are viable.

In this section the most widely applied validation characteristics are explained; accuracy, precision (repeatability and reproducibility/intermediate precision), specificity, limit of detection, limit of quantitation, linearity, robustness and stability of analytical solutions.

Accuracy

An analytical method is accurate if it gives the right numerical value for the analyte (either mass or concentration) and can be described as the degree of closeness of measurements of a quantity to its actual value. A method almost never gives the exact same results for replicate analyses, which means that the result is presented as the mean or average. A pragmatic way to express accuracy is to present it in terms of the standard error, which is the difference between the observed and the expected concentrations of the analyte. To determine accuracy, a common practice is to analyze a known amount of standard material under different conditions in a formulation, bulk material or intermediate product to ensure that nothing interferes with the method.

Precision

Precision, this is also referred to as reproducibility or repeatability, defines how reproducible the acquired results are and gives you assurance in the attained data. Repeatability is the measure of how easy it is for an analyst in a given laboratory to attain the same result for the same batch of samples (normally by injecting the same samples repeatedly at different concentration levels) using the same method and using the same equipment and reagents. Reproducibility or intermediate precision measures the variations within or between days, analysts and equipment. High precision quantitative results should be expected, but depending if it is a pharmaceutical assay or a bio-analytical method, different acceptance criteria govern. In pharmaceutical quality control there are much more stringent method requirements and less variation amongst samples compared to analysis of patient plasma- or serum samples. For any assay, the relative standard deviation (RSD) or coefficient of variation (CV) is used as indication of the imprecision of the method. From a practical perspective, six to ten replicate injections will give you a good idea of the precision of the method. An analytical method can be accurate but not precise, precise but not accurate, neither, or both.

Specificity

Specificity is an important parameter to test in a validation program as it verifies the ability of the method to accurately measure the analyte response in the presence of all potential sample components. The analyte response from a solution containing only the analyte is compared with test samples containing the analyte and all potential sample components (placebo, synthesis intermediates, excipients, degradation products and impurities). For pharmaceuticals, stress conditions such as heat, light, acid, base and oxidant are typical. For formulated products, heat, light and humidity are commonly used to stress the samples. The analyte peak is evaluated in all test samples for peak purity and resolution from the nearest eluting peak.

Limits of detection and quantitation

The limit of detection (LOD) is defined as the least amount of an analyte in a sample that can be detected, and commonly expressed as the concentration level that is able to provide a signal-to-noise ratio of three ($S/N=3$). Limit of quantitation (LOQ) is defined as the lowest analyte concentration level that can be quantified with good precision and accuracy, and providing a signal-to-noise ratio of ten ($S/N=10$). LOD and LOQ can also be determined based on the standard deviation of the response and the slope of the calibration curve.

Linearity

The linearity of an analytical method is the capability to generate results that are directly proportional to the concentration of analyte in the sample. It is commonly illustrated as the interval between the upper and lower analyte concentration levels that may be determined with precision and accuracy. Linearity data is often calculated using the calibration curve correlation coefficient and the y-intercept. The relative standard deviation (RSD), intercept and slope of the calibration curve should also be calculated.

Robustness

The method robustness is a measure on how well an analytical method remains unaffected by small variations in the experimental conditions, but also how reliable the method is during normal use. Important parameters to monitor are changes in the mobile phase composition; mobile phase pH; changes in the gradient profile; changes in the buffer concentration; column temperature; and injection volume.

Analytical solution stability

Analytical solution stability can be divided into different sections; recovery; dilution; internal standard addition, etc. If an extraction process is used (either liquid-liquid or solid phase extraction) it must provide proper analyte recovery. A method with low analyte recovery and/or where the analyte is degraded during the sample preparation is not tolerable for routine quality control. Internal or external standards (reference substances) should be prepared in such way that they maintain their potency, and produce same response over time. Samples and standards should be tested for stability to verify stability over a normal analysis cycle. A rule of thumb is that the sample solutions, standard solutions and HPLC mobile phase should be stable for minimum 24 hours under defined storage conditions.

Further reading

www.merckmillipore.com/chromatography

Method development & optimization

- 1 | Selection of the HPLC method and system
- 2 | Establish sample prep procedure
- 3 | Select the detector
- 4 | Selection of initial conditions
- 5 | Mobile phase selection
- 6 | Selectivity optimization
- 7 | System optimization
- 8 | Method validation
- 9 | Scaling of HPLC methods

9 Scaling of HPLC methods

Scaling from HPLC to UHPLC

A transfer of HPLC methods to UHPLC requires scaling down from bigger inner diameter columns (e.g. 4.6 mm i.d.) to smaller inner diameter columns (e.g. ~2.1 mm i.d.) and from long columns (e.g. 150 mm length) to short columns (e.g. 50 mm length) in addition to the reduction of particle sizes (from e.g. 5 μm to 2 μm).

To ensure equivalent chromatographic separation, it is also necessary to scale the flow rate, injection volume and the gradient parameters.

Adjusting the column length

The first step is to determine the appropriate column length in order to maintain the same separation. Keeping the same column length while decreasing the particle size will increase the number of theoretical plates as well as backpressures. Therefore, when decreasing particle size, column length can be shortened without losing resolution.

$$\text{Column length } L_2 = L_1 \times dp_2 / dp_1$$

L_1 – HPLC column length
 L_2 – UHPLC column length
 dp_1 – HPLC particle size
 dp_2 – UHPLC particle size

Scaling the flow rate

Decreasing the internal diameter of the column (e.g. from 4.6 mm to 2.1 mm) requires recalculating column flow rate in order to maintain linear velocity. Linear velocity is defined as the distance which mobile phase travels over time (cm/min), whereas flow rate is the volume of mobile phase that travels over time (mL/min). To maintain the same linear velocity through a column with a smaller internal diameter, the flow rate must be decreased proportionally to the column internal diameter according to the equation below.

$$\text{Flow rate } f_2 = f_1 \times (d_2)^2 / (d_1)^2$$

f_1 – HPLC flow rate
 f_2 – UHPLC flow rate (mL/min)
 d_1 – HPLC column ID
 d_2 – UHPLC column ID (mm)

Scaling the injection volume

Decreasing the column internal diameter and length, decreases the overall column volume and sample capacity. Therefore, we must alter the injection volume. Please note that since overall column volume has decreased, it is more important to match the sample solvent to the starting mobile phase composition. Mismatched sample solvents can cause irreproducible retention times, efficiencies, and even changes in selectivity. If using a larger injection volume than calculated, check for peak abnormalities and irreproducibility that could result from phase overload.

$$\text{Inject. volume } V_2 = V_1 \times (d_2^2 / d_1^2) \times (L_2 / L_1)$$

V_1 – HPLC Injection volume
 V_2 – UHPLC Injection volume
 d_1 – HPLC column ID
 d_2 – UHPLC column ID (mm)
 L_1 – HPLC column length
 L_2 – UHPLC column length

Adjusting gradient time

When an analytical method is scaled down, the time program of the gradient also needs to be scaled down to keep the gradient volume the same.

$$\text{Time: } t_2 = t_1 \times (f_1 / f_2) \times (d_2^2 / d_1^2) \times (L_2 / L_1)$$

t_1 – HPLC time
 t_2 – UHPLC time
 f_1 – HPLC flow rate
 f_2 – UHPLC flow rate (mL/min)
 L_1 – HPLC column length
 L_2 – UHPLC column length

Method development & optimization

Scaling of HPLC methods

Scaling a HPLC method

from Purospher® STAR 5 µm column dimension 150-4.6 mm
to Purospher® STAR 2 µm column dimension 50-2.1 mm

Separation of a mixture of 5 hormones was scaled from HPLC to UHPLC conditions. All calculations were following the equations on the previous page.

Flow rate $f_2 = 1.3 \times 2.12 / 4.62 = 0.27 \text{ mL/min}$

Time $t_2 = 15 \times (0.5 / 0.105) \times (2.1^2 / 4.6^2) \times (50 / 150) = 5 \text{ min}$

Inject. volume $V^2 = 10 \times (2.12 / 4.62) \times (50 / 150) = 0.7 \text{ µL}$

Alkylphenone standard

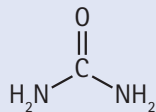

1. Urea

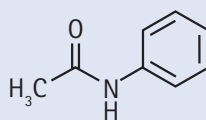

2. Acetanilide

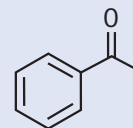

3. Acetophenone

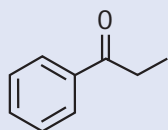

4. Propiophenone

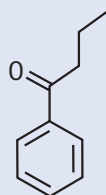

5. Butyrophenone

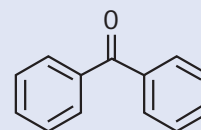

6. Benzophenone

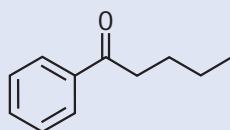

7. Valerophenone

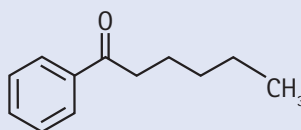

8. Hexanophenone

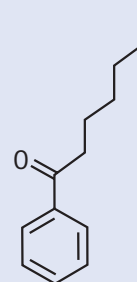

9. Heptanophenone

Purospher® STAR RP-18 endcapped, 5 µm

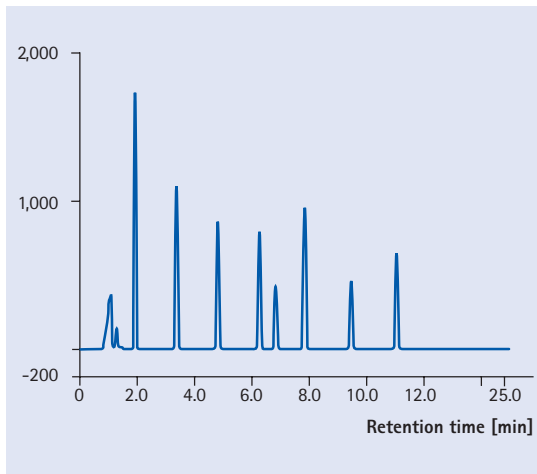

Column	Purospher® STAR RP-18e (5 µm) LiChroCART® 150-4.6 mm		
Mobile phase	A: Milli Q Water B: Acetonitrile		
Gradient	Time [min]	% A	% B
	0.0	55	45
	15.0	55	45
Flow rate	1.3		
Detection	UV 247 nm		
Temperature	40°C		
Equilibration	7.5 min		
Injection volume	10 µL		
Sample	Alkylphenone standard		
	1. Urea		
	2. Acetanilide		
	3. Acetophenone		
	4. Propiophenone		
	5. Butyropfenone		
	6. Benzophenone		
	7. Valerophenone		
	8. Hexanophenone		
	9. Heptanophenone		

Purospher® STAR RP-18 endcapped, 2 µm

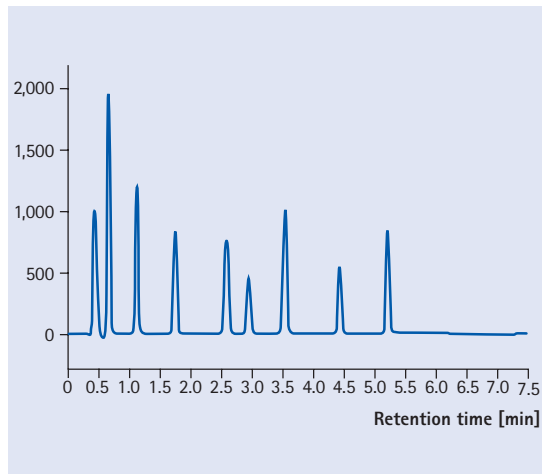

Column	Purospher® STAR RP-18e (2 µm) Hibar® HR 50-2.1 mm		
Mobile phase	A: Milli Q Water B: Acetonitrile		
Gradient	Time [min]	% A	% B
	0.0	55	45
	5.0	55	45
Flow rate	0.27		
Detection	UV 247 nm		
Temperature	40°C		
Equilibration	2.5 min		
Injection volume	0.7 µL		
Sample	Alkylphenone standard		
	1. Urea		
	2. Acetanilide		
	3. Acetophenone		
	4. Propiophenone		
	5. Butyropfenone		
	6. Benzophenone		
	7. Valerophenone		
	8. Hexanophenone		
	9. Heptanophenone		

Method development & optimization

Scaling of HPLC methods

Speed up a scaled method

After the method is scaled to a smaller column dimension, the next step is to increase speed by flow rate. The gradient was adjusted according to the equation:

$$\text{Time} \quad t_2 = t_1 \times f_1 / f_2$$

$$\text{Time} \quad t_2 = 5 \times (0.27 / 1.08) = 1.25 \text{ min}$$

Purospher® STAR RP-18 endcapped, 2 µm

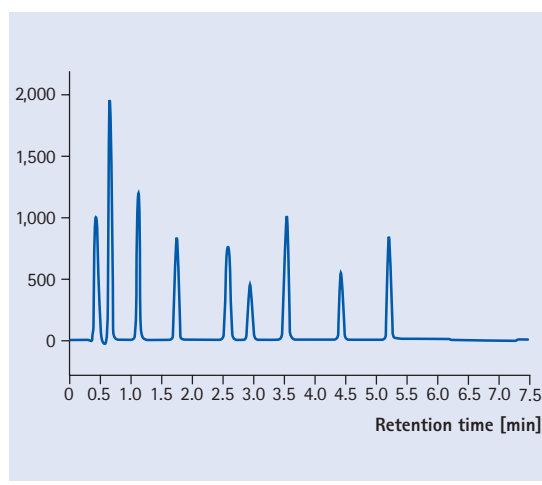

Column	Purospher® STAR RP-18e (2 µm) Hibar® HR 50-2.1 mm		
Mobile phase	A: Milli Q Water B: Acetonitrile		
Gradient	Time [min]	% A	% B
	0.0	55	45
	5.0	55	45
Flow rate	0.27		
Detection	UV 247 nm		
Temperature	40°C		
Equilibration	2.5 min		
Injection volume	0.7 µL		
Sample	Alkylphenone standard		

Purospher® STAR RP-18 endcapped, 2 µm

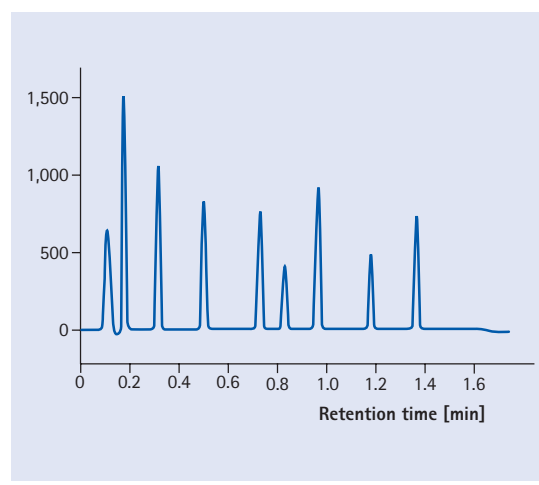

Column	Purospher® STAR RP-18e (2 µm) Hibar® HR 50-2.1 mm		
Mobile phase	A: Milli Q Water B: Acetonitrile		
Gradient	Time [min]	% A	% B
	0.0	55	45
	1.25	55	45
Flow rate	1.08		
Detection	UV 247 nm		
Temperature	40°C		
Equilibration	0.625 min		
Injection volume	0.7 µL		
Sample	Alkylphenone standard		

Scaling from HPLC to UHPLC can speed up the separation up to 10 times and save solvent by up to 90 % at the same time. The separation of 9 alkylphenones shown in the example was achieved in 22.5 minutes using a 150-4.6 mm Purospher® STAR 5 µm column at 1.3 mL/min flow rate (29.5 mL per run). The method was scaled to a column dimension of 50-2.1 mm using a 2 µm material of the same sorbent. The new UHPLC method total run time is 2.15 minutes including re-equilibration of the gradient at a flow rate of 1.08 mL/min (2.03 mL per run).

Ramipril and Related Substances – from HPLC to UHPLC

The benefit of scaling from HPLC to UHPLC is illustrated with the USP36 –NF31 monograph method for ramipril related compounds, where the liquid chromatograph should be equipped with 210 nm detector and a 250 x 4.0 mm column that contains 3 µm packing L1 (RP-18) and is maintained at a temperature of 65°C.

Within the scope of allowed monograph method changes, and only to perform partial revalidation, this method can be changed by:

- Reduction of particle size to maximum 1.5 µm (50 %)
- Shortening the column to a length of 75 mm (70 %)
- Reduction of inner diameter if linear velocity is kept constant
- Reduction of injection volume as long as limit of detection (LOD) and linearity is OK.

Using the same mobile phases and gradient program as per monograph, this method was first finalized on a 250x4.6 mm Purospher® STAR RP-18 endcapped column with 5 µm packing, page 20, and thereafter scaled to a 100x2.1 mm Purospher® STAR RP-18 endcapped column with 2µm packing, see page 21. The UHPLC application is an allowed monograph modification per USP guidelines but the application using the larger HPLC column is not allowed. It is possible to reduce particle size, by maximum 50 %, but no increase.

Performance criteria

Chromatograph the Resolution solution, and record the peak responses as directed for Procedure: the resolution, R, between ramipril related compound A and ramipril is not less than 3.0. Similarly chromatograph the Test solution, and record the peak responses as directed for procedure: the retention time for ramipril is between 16 and 19 minutes; and the tailing factor for the ramipril peak is between 0.8 and 2.0. Chromatograph the Standard solution, and record the peak responses as directed for Procedure: the relative standard deviation for replicate injections is not more than 5.0 %. [The relative retention times are about 0.8 for ramipril related compound A, 1.0 for ramipril, 1.3 for ramipril related compound B, 1.5 for ramipril related compound C, and 1.6 for ramipril related compound D.]

NOTE: no Ramipril related compound C and D were available at time of developing this application. Thus reason why it is not marked as an USP method, despite it follow the monograph experimental conditions.

Method development & optimization

Scaling of HPLC methods

Ramipril and Related Substances – Purospher® STAR RP-18 endcapped (HPLC)

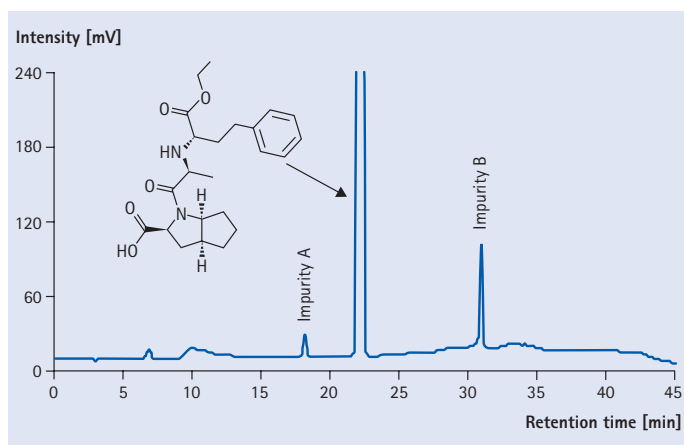

Column	Purospher® STAR RP-18 endcapped (5 µm) Hibar® RT 250 x 4.6 mm		
Mobile phase	A: Dissolve 2.0 g of sodium perchlorate in a mixture of 800 mL of Milli-Q water and 0.5 ml of triethyl-amine. Adjust pH to 3.6 with phosphoric acid. Add 200 mL and acetonitrile and mix. B: Dissolve 2.0 g of sodium perchlorate in a mixture of 300 mL of Milli-Q water and 0.5 ml of triethyl-amine. Adjust pH to 2.6 with phosphoric acid. Add 700 mL acetonitrile and mix.		
Gradient	Time [min]	% A	% B
	0.0	90	10
	6.0	90	10
	7.0	75	25
	20.0	65	35
	30.0	25	75
	40.0	25	75
	45.0	90	10
	55.0	90	10
Flow rate	1.0 mL/min		
Detection	UV 210 nm		
Cell	10 µL		
Temperature	65°C		
Diluent	Solution A		
Injection volume	10 µL		
Pressure drop	61 to 74 Bar (884 to 1073 psi)		
Sample	Dissolve 25 mg of sample in diluent and dilute to 25 ml with same solvent.		

Chromatographic Data			
Compound	RT [min]	RRT	Asymmetry
1. Ramipril RS A	18.2	0.82	1.0
2. Ramipril	22.2	1.00	1.0
3. Ramipril RS B	30.9	1.39	1.0

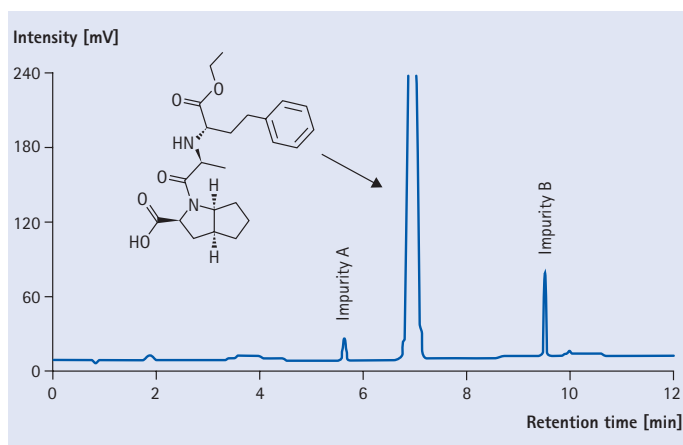

Column	Purospher® STAR RP-18 endcapped (2 µm) Hibar® RT 100 x 2.1 mm		
Mobile phase	A: Dissolve 2.0 g of sodium perchlorate in a mixture of 800 mL of Milli-Q water and 0.5 ml of triethyl-amine. Adjust pH to 3.6 with phosphoric acid. Add 200 mL and acetonitrile and mix. B: Dissolve 2.0 g of sodium perchlorate in a mixture of 300 mL of Milli-Q water and 0.5 ml of triethyl-amine. Adjust pH to 2.6 with phosphoric acid. Add 700 mL acetonitrile and mix.		
Gradient	Time [min]	% A	% B
	0.0	90	10
	1.66	90	10
	1.93	75	25
	5.54	65	35
	8.31	25	75
	11.08	25	75
	12.46	90	10
	15.23	90	10
Flow rate	0.3 mL/min		
Detection	UV 210 nm		
Cell	2.5 µL (use 0.1 mm tubing)		
Temperature	65°C		
Diluent	Solution A		
Injection volume	2 µL		
Pressure drop	196 to 164 Bar (2827 to 2378 psi)		
Sample	Dissolve 25 mg of sample in diluent and dilute to 25 ml with same solvent.		

Chromatographic Data			
Compound	RT [min]	RRT	Asymmetry
1. Ramipril RS A	5.6	0.81	1.1
2. Ramipril	6.9	1.00	1.1
3. Ramipril RS B	9.5	1.38	1.1

'does not need full revalidation'

Ramipril and Related Substances – from HPLC to UHPLC

As can be seen on the left page, both columns meet the performance criteria in terms of:

- a) The resolution, R, between ramipril related compound A and ramipril (not less than 3.0)
- b) The relative retention time between ramipril related compound A (ramipril RS A), ramipril and ramipril related compound B (ramipril RS B)
- c) The tailing factor for the ramipril peak (between 0.8 and 2.0).
- d) The application using HPLC conditions also meet the retention time requirement for ramipril

The UHPLC column – Purospher® STAR RP-18 endcapped (2 µm) 100 x 2.1 mm thus seem to meet monograph and the customer would benefit from:

1. Faster method (Time-saving: 40 minutes per sample or 360 %)

(yes ... the column length is 60 % shorter and this provides 60 % time saving but the real gain is to scale the method to a column with smaller particle size and not having to keep same linear velocity).

2. Higher chromatographic resolution and efficiency

... but this is not true. The retention time requirement for ramipril is NOT between 16 and 19 minutes. In addition, the flow rate has not been scaled to maintain same linear velocity.

Monograph method is documented at 1.0 mL/min on 4.6 mm column and thus the flow rate should be reduced by a factor of 4.8 for the 2.1 mm i.d. UHPLC column, calculations see page 18. A flow rate of 0.2 mL/min should have been used instead of 0.3 mL/min. With the current experimental conditions, this would give comments from an auditor and very likely a request for method change.

The larger Purospher® STAR RP-18 endcapped (5 µm) 250 x 4.6 mm column can definitely not be used. The particle size is larger than monograph method and would require complete revalidation and discussion with auditor and authorities. Most likely it would not be an accepted method.

More information about Merck Millipore UHPLC columns and how to appropriately scale methods can be found at www.merckmillipore.com/chromatography; in Chrombook and the 2013 application guide – UHPLC².

Pharmacopeial requirements

Introduction

The regulation of medicinal products dates back several hundred years. In the late 15th century King Henry VIII gave the Royal College of Physicians of London the power to inspect apothecaries' products in the London area and to destroy defective stock. The first list of approved drugs (with manufacturing guidelines) was published in 1618 by the London Pharmacopeia, and the first edition of the British Pharmacopeia (BP) was published in 1864 being one of the first attempts to harmonize pharmaceutical standards, through the merger of the London, Edinburgh and Dublin Pharmacopeias. Today, we can purchase certified reference standards from several official bodies.

The United States Pharmacopeia (USP) was founded in 1820. Over the last two centuries massive progress has been made around the globe to make drugs safe for consumers, both on a national as well as on an international level, thus assuring the potency of commercially available drug products. Depending where (in which country or region) a finalized drug product will be used it must meet the specified regulations and thus many pharmaceutical companies work from several pharmacopeias. In this chapter the European (EP) and United States Pharmacopeia (USP) will be discussed.

Important abbreviations

BP	British Pharmacopeia
EP	European Pharmacopeia
IPC	Indian Pharmacopeia
USP	United States Pharmacopeia
API's	Active Pharmaceutical Ingredient's
EDQM	European Directorate for the Quality of Medicines and Healthcare
ICH	International Conference of Harmonization
RS	Related substances
USFDA	United States Food and Drug Administration
AAS	Atomic absorption spectroscopy
GC	Gas chromatography
HPLC	High performance liquid chromatography
HPTLC	High performance thin layer chromatography
TLC	Thin layer chromatography

One of the more important improvements is the requirement for impurity profiling or in other words the analysis of related substances (RS) monographs. At present, various regulatory authorities like the International Conference of Harmonization (ICH), European Directorate for the Quality of Medicines and Healthcare (EDQM), United States Food and Drug Administration (USFDA), and the Canadian Drug and Health Agency are all emphasizing the purity requirements and the identification of impurities in Active Pharmaceutical Ingredient's (API's) and formulated drugs. The ICH Harmonized Tripartite Guideline, 'Impurities in new drug substances', Q3A(R2), states that all actual and likely impurities in a new drug substance should be summarized and laboratory studies conducted to detect these impurities. Qualification of the impurities is the process of acquiring and evaluating data that establishes biological safety of an individual impurity; thus revealing the need and scope of impurity profiling of drugs in pharmaceutical research and manufacturing. That said, assay and potency methods of pharmaceuticals are likely the most common chromatographic analysis around the world. The requirements for an assay are less stringent than for an impurity profiling. Contaminants need only be separated from the main component and the focus is more on accuracy, precision, range and linearity.

Assay and potency methods as well as identification of impurities are carried out with various analytical techniques, and where different chromatographic and spectroscopic techniques are common; either alone or in combination with other techniques. Thin layer chromatography (TLC), high performance thin layer chromatography (HPTLC), gas chromatography (GC), high performance liquid chromatography (HPLC), and atomic absorption spectroscopy (AAS) in addition to more classical tests based on titration are commonly used. HPLC has especially been widely exploited for impurity profiling methods. The reasons for this are the wide range of detectors available that connect easily with HPLC along with the variety of column chemistries (stationary phases) commercially available. Very simply, with HPLC it is possible to develop robust and reliable methods having necessary sensitivity and linearity that meet requirements in selectivity and provide cost effectiveness to the laboratory.

On the following pages, detailed information from USP and EP will be used and explained and also how this information applies to the pharmacopeia. A monograph method represents published standards by which the use of one or more substances is automatically authorized. Thus by following the specific method and complying with set specifications a manufacturer can prove the safety of their products. Thus, examples are shown herein how validation of monograph methods can be carried out, and remember, Merck Millipore analytical chromatography columns can be an excellent choice for your assay and/or impurity-profiling needs.



Changing a regulated method

What changes are allowed in a monograph method?

- Can we change the column material?
- Are we allowed to use a different column dimension?
- Is it allowed to scale down to smaller ID columns to save solvent?
- Is there a possibility to speed up separation?

The answer is "yes" to all these questions... but how?

Factors that may affect chromatographic behavior:

1. Composition, ionic strength, temperature, and apparent pH of the mobile phase
2. Flow rate, column dimensions, column temperature, and pressure
3. Stationary phase characteristics, including type of chromatographic support (particle-based or monolithic), particle or macropore size, porosity, and specific surface area
4. Reversed-phase and other surface modification of the stationary phases, the extent of chemical modification (as expressed by end-capping, carbon loading, etc.)

In some circumstances, it may be desirable to use an HPLC column with different dimensions to those prescribed in the official procedure (different length, internal diameter, and/or particle size). In either case, changes in the chemical characteristics ("L" designation) of the stationary phase will be considered a modification to the method and will require full validation. Adjustments to the composition of the mobile phase in gradient elution may cause changes in selectivity and are not recommended. If adjustments are necessary, change in column packing (maintaining the same chemistry), the duration of an initial isocratic hold (when prescribed), and/or dwell volume adjustments are allowed. Additional allowances for gradient adjustment are noted in the following text and table for USP monographs.

	United States Pharmacopeia (USP)	European Pharmacopeia (EP)
Column length*	See separate instructions, next paragraph: Changes in USP 37	± 70 %
Column inner diameter (ID)	See separate instructions, next paragraph: Changes in USP 37	± 25 %
Particle size	See separate instructions, next paragraph: Changes in USP 37	Reduction of 50 %, no increase
Flow rate	See separate instructions, next paragraph: Changes in USP 37	± 50 %
Column temperature	± 10°C	± 10°C (max 60°C)
Injection volume	May be decreased (if LOD and repeatability is OK)	May be decreased (if LOD and repeatability is OK)
pH	± 0.2 units	± 0.2 units
UV wavelength	No adjustment is permitted	No adjustment is permitted
Buffer salts concentration	± 10 %	± 10 %
Mobile phase composition	± 30 % relative, or ± 10 % absolute whichever is smaller	± 30 % relative, or ± 30 % absolute whichever is larger

Column length* A guard column may be used with the following requirements, unless otherwise is indicated in the individual monograph (USP): **(a)** the length of the guard column must be NMT 15 % of the length of the analytical column, **(b)** the inner diameter must be the same or smaller than that of the analytical column, and **(c)** the packing material should be the same as the analytical column (e.g., silica) and contain the same bonded phase (e.g., C18). In any case, all system suitability requirements specified in the official procedure must be met with the guard column installed. **Linear velocity** the speed at which the mobile phase travels through the column, for example, in millimeters per second. For comparison of equivalent conditions between columns of different internal diameters, the linear velocity should be kept constant. To keep linear velocity constant, the flow rate should be adjusted in proportion to the column cross-sectional area, which is directly proportional to the square of the ratio of column diameters.

Changes in USP 37 | Particle size (HPLC)

For isocratic separations, the particle size and/or the length of the column may be modified provided that the ratio of the column length (L) to the particle size (dp) remains constant or into the range between -25 % to +50 % of the prescribed L/dp ratio. **Alternatively (as for the application of particle-size adjustment to superficially porous particles), other combinations of L and dp can be used provided that the number of theoretical plates (N) is within -25 % to +50 %, relative to the prescribed column¹⁾.**

¹⁾ This means that monolithic columns are treated similar to the core shell columns where the particle size is irrelevant. In those cases a monograph allows to make the adjustment using the calculation of N in the particular procedure.

Caution should be taken when the adjustment results in a higher number of theoretical plates which generates smaller peak volumes, which may require adjustments to minimize extra-column band broadening by factors as instrument plumbing, detector cell volume and sampling rate, and injection volume. When particle size is not mentioned in the monograph, the ratio must be calculated using the largest particle size consigned in the USP definition of the column. For gradient separations, changes in length, column inner diameter and particle size are not allowed.

Changes in USP 37 | Flow rate (HPLC)

When the particle size is changed, the flow rate may require adjustment, because smaller-particle columns will require higher linear velocities for the same performance (as measured by reduced plate height). Flow rate changes for both a change in column diameter and particle size can be made by:

$$F_2 = F_1 \times [(dc_2^2 \times dp_1)/(dc_1^2 \times dp_2)]$$

where F_1 and F_2 are the flow rates for the original and modified conditions, respectively; dc_1 and dc_2 are the respective column diameters; and dp_1 and dp_2 are the particle sizes. When a change is made from $\geq 3 \mu\text{m}$ to $< 3 \mu\text{m}$ particles in isocratic separations, an additional increase in linear velocity (by adjusting flow rate) may be justified, provided that the column efficiency does not drop by more than 20 %. Similarly, a change from $< 3 \mu\text{m}$ to $\geq 3 \mu\text{m}$ particles may require additional reduction of linear velocity (flow rate) to avoid reduction in column efficiency by more than 20 %.

Changes in USP 37 | Changes in F, dc, and dp are not allowed for gradient separations

Additionally, the flow rate can be adjusted by $\pm 50 \%$ (isocratic only). **Examples:** Adjustments in column length, internal diameter, particle size, and flow rate can be used in combination to give equivalent conditions (same N), but with differences in pressure and run time. The following table lists some of the more popular column configurations to give equivalent efficiency (N), by adjusting these variables.

Length [L]	Column diameter [dc]	Particle size [dp]	Relative values: L/dp	F	N	Pressure	Run time
250 mm	4.6 mm	10 μm	25000	0.5	0.8	0.2	3.3
150 mm	4.6 mm	5 μm	30000	1.0	1.0	1.0	1.0
150 mm	2.1 mm	5 μm	30000	0.2	1.0	1.0	1.0
100 mm	4.6 mm	3.5 μm	28600	1.4	1.0	1.9	0.5
100 mm	2.1 mm	3.5 μm	28600	0.3	1.0	1.9	0.5
75 mm	4.6 mm	2.5 μm	30000	2.0	1.0	4.0	0.3
75 mm	2.1 mm	2.5 μm	30000	0.4	1.0	4.0	0.3
50 mm	4.6 mm	1.7 μm	29400	2.9	1.0	8.5	0.1
50 mm	2.1 mm	1.7 μm	29400	0.6	1.0	8.5	0.1

For example, if a monograph specifies a 150 x 4.6 mm; 5 μm column operated at 1.5 mL/min, the same separation may be expected with a 75 x 2.1 mm; 2.5 μm column operated at 1.5 mL/min x 0.4 = 0.6 mL/min, along with a pressure increase of about four times and a reduction in run time to about 30 % of the original.

Changes in USP 37 | Injection volume (HPLC)

The injection volume can be adjusted as far as it is consistent with accepted precision, linearity, and detection limits. Note that excessive injection volume can lead to unacceptable band broadening, causing a reduction in N and resolution. Applies to both gradient and isocratic separations. The easiest approach to scale the injection volume is to compare differences in column tube volume and to keep same volumetric ratio between tube volume and injection volume, and thereby same volume loading on the column. A method scaled from a 250 x 4.6 to 100 x 2.1 mm column require a 12-fold reduction of injection volume using simple volume calculation of a tube (i.e. 250 x 4.6 = 4.15 mL and 100 x 2.1 = 0.346 mL). Thus if injection volume is 20 μL on the larger column, it is recommended to inject not more than 2 (1.7) μL on the smaller column.

Ratio of components in mobile phase

The following adjustment limits apply to minor components of the mobile phase (specified at 50 % or less). The amounts of these components can be adjusted by ± 30 % relative. However, the change in any component cannot exceed ± 10 % absolute (i.e., in relation to the total mobile phase). Adjustment can be made to one minor component in a ternary mixture. Examples of adjustments for binary and ternary mixtures are given below.

Binary Mixtures specified ratio of 50:50. 30 % of 50 is 15 % absolute, but this exceeds the maximum permitted change of ± 10 % absolute in either component. Therefore, the mobile phase ratio may be adjusted only within the range of 40:60 to 60:40 specified ratio of 2:98. 30 % of 2 is 0.6 % absolute. Therefore the maximum allowed adjustment is within the range of 1.4:98.6 to 2.6:97.4.

Ternary Mixtures specified ratio of 60:35:5. For the second component, 30 % of 35 are 10.5 % absolute, which exceeds the maximum permitted change of ± 10 % absolute in any component. Therefore the second component may be adjusted only within the range of 25 % to 45 % absolute. For the third component, 30 % of 5 is 1.5 % absolute. In all cases, a sufficient quantity of the first component is used to give a total of 100 %. Therefore, mixture ranges of 50:45:5 to 70:25:5 or 58.5:35:6.5 to 61.5:35:3.5 would meet the requirement.

Wavelength of UV-visible detector

Deviation is not permitted from the specified wavelength. The procedure specified by the detector manufacturer, or another validated procedure, is used to verify that error in the detector wavelength is, at most, ± 3 nm.

Choosing the right column to meet monograph specifications

The HPLC column choice is very important to consider; otherwise it is difficult to meet the set requirements in a monograph method. In the chapter discussing column selection, we have outlined which USP classification (code) our HPLC columns belong to. At present, Merck Millipore offers L1, L3, L7, L8, L10, L20, L29 and L45 modifications. In addition, the USP has a database for chromatography columns to help users to cross-reference HPLC columns. However, it is important to keep in mind that this database is only a helping tool and "the database itself is not part of the text of USP-NF, and does not constitute an official interpretation of such text. The databases being displayed at the site are provided for informational purposes only to assist users in finding HPLC columns equivalent to that used to develop and validate a particular chromatographic procedure. After finding suggestions of equivalent columns using the databases, the columns should be tested with the appropriate sample. USP and the authors of the databases are not responsible for the results obtained with the columns proposed by the databases and such results should not be relied on to demonstrate compliance with USP standards or requirements. The data being provided by the databases were generated using brand new columns. USP has no information on and disclaims any knowledge of how these procedures will perform when evaluating already used columns".

Thus it has not been verified for each and every monograph method. We at Merck Millipore have experienced that our columns can easily meet monograph specifications despite the fact that they may seem very different from the column used when developing the original monograph method. Also it important to keep in mind that those columns mentioned in USP as monograph columns is not bound text – the actual monograph only describe the column geometry and classification.

System Suitability Test (SST)

To verify and validate a monograph method and meet set requirements defined, system suitability tests are described.

1. SST is used to verify that the chromatographic system is adequate for the intended analysis.
2. SST is based on the concept that the equipment, electronics, analytical operations, and samples analyzed constitute an integral system that can be evaluated as such

As long as the changes of a monograph method are within the limits shown above it is possible to carry out only a partial revalidation followed by internal documentation of the updated method. If the changes are beyond limits complete revalidation and documentation is required followed by a discussion with an auditor and regulating authorities for approval of the new method. It is (of course) also possible to submit completely new monograph methods to authorities.

Amlodipine Besylate and Related Substances (USP36–NF31) – Case Study

The current impurity profiling (Related Substances) method for amlodipine besylate is based on TLC (test 1) and HPLC (test 2) where the liquid chromatograph is equipped with a UV detector (237 nm) and a 150 x 3.9 mm column that contains packing L1. No specific particle size is mentioned in the monograph and any type of column backbone can be used. The flow rate is about 1.0 mL per minute. The first example shows the separation using a 150 x 4.6 mm Purospher® STAR RP-18 endcapped column with 5 µm particle size; a close match to the 150 x 3.9 mm geometry mentioned by the monograph. The second example shows the separation using a Chromolith® HighResolution RP-18 endcapped 100 x 4.6 mm column.

Performance criteria

For the purpose of identification, the relative retention times are about 0.2 for benzene sulfonate, 0.5 for amlodipine impurity A, and 1.0 for amlodipine. Amlodipine impurity A is 3-ethyl 5-methyl 2-[(2-aminoethoxy)methyl]-4-(2-chlorophenyl)-6-methylpyridine-3,5-dicarboxylate.

As illustrated in the figures, both columns meet the performance criteria. Thus both column options can be considered. With the shorter 100 x 4.6 mm Chromolith® HighResolution column the method will run faster (a time-saving of 10 minutes per sample). The column length is 33 % shorter but the total chromatographic analysis time is shortened by 50 %; an evidence of benefits with a monolithic rod over a particle packed column. The Chromolith® HighResolution column provides, in addition, higher chromatographic resolution which leads to sensitivity enhancements of the method. The Chromolith® HighResolution column provide chromatographic performance comparable to sub-3 µm particle packed columns and the eluting peaks will appear with more narrow width and thus higher peak amplitude is attained.

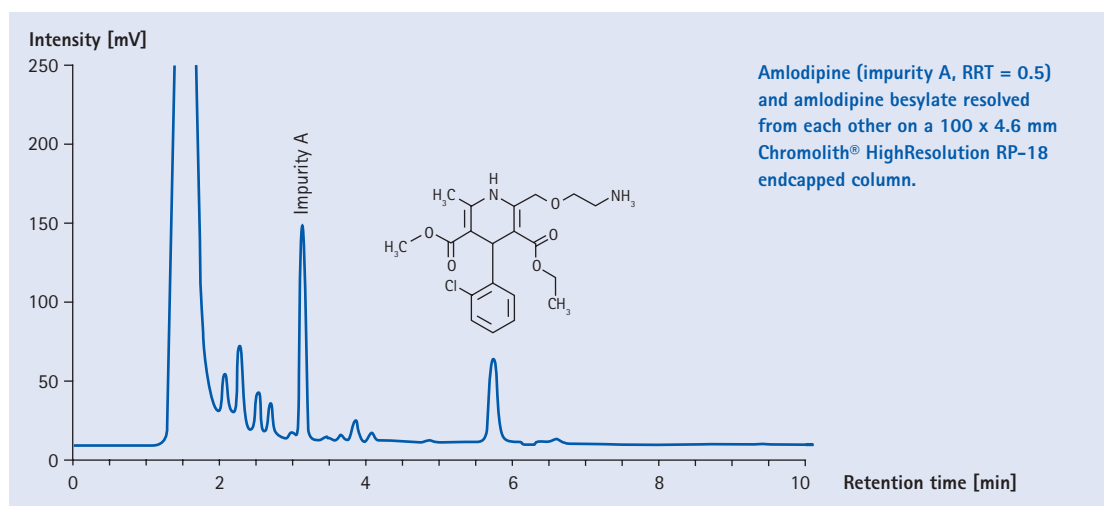
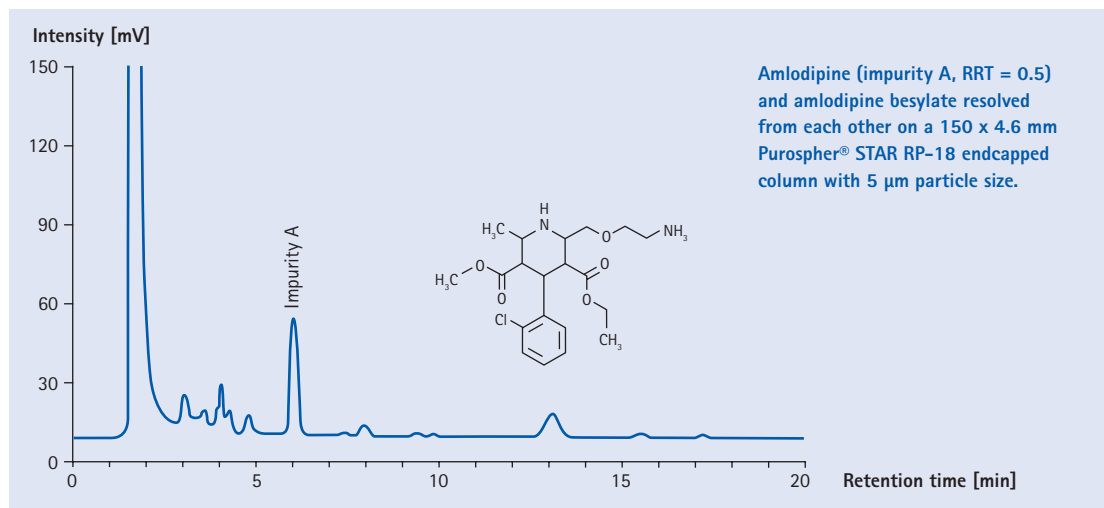

United States Pharmacopeia (USP)

The process of validating a new analytical procedure for compendial usage is addressed in USP general Chapter 1225 – "Validation of Compendial Procedures". However, even with a fully validated procedure, the end-user may not have assurance that the procedure is suitable for use with a specific ingredient or product in a specific laboratory with specific personnel, equipment, consumables and reagents. USP therefore developed chapter 1226 in response to industry's request to provide instructions for verifying compendial procedures in specific situations. Here we have addressed USP's proposed new general chapter 1226 "Verification of Compendial Procedures" which is intended to fill the gap in the proper usage of compendial procedures by outlining a process for verifying their suitability. The role of HPLC columns is of immense importance to meet system suitability test (SST) criteria in compendial methods.

Validation of compendial procedure <1225>

1. Defines analytical performance characteristics
2. Recommends data for submission to USP-NF
3. Provides guidance on which analytical performance characteristics are needed based on the type of test
4. Incorporates ICH guidelines Q2A and Q2B

Performance characteristics	Category 1	Category 2		Category 3	Category 4
		Quantitative	Limit test		
Accuracy	Yes	Yes	-	-	No
Precision	Yes	Yes	No	Yes	No
Specificity	Yes	Yes	Yes	-	Yes
LOD	No	Yes	Yes	-	No
LOQ	No	No	No	-	No
Linearity	Yes	Yes	No	-	No
Range	Yes	Yes	-	-	No

Verification of compendial procedures <1226>

The intention of this USP chapter is to provide general information to laboratories on the verification of compendial procedures that are being performed for the first time to yield acceptable results utilizing the laboratories' personnel, equipment, and reagents. This is not applicable for retroactive application to already successfully-established laboratory procedures. Verification consists of assessing selected Analytical Performance Characteristics, such as those described in chapter 1225, to generate appropriate, relevant data rather than repeating the validation process. The table below illustrates required tests for the USP chapters dealing with validation and verification.

Performance	Validation	Verification
Accuracy	Yes	No
Precision	Yes	Maybe
Specificity	Yes	Yes
LOD	No	No
LOQ	Yes	Yes
Linearity	Yes	No
Range	Yes	No

Why USP <1226> is needed:

1. 21 CFR 211.194 (a)(2): "users of analytical methods described in USP–NF are not required to validate the accuracy and reliability of these methods, but merely verify their suitability under actual conditions of use".
2. Response to industry inquiries
3. Verification consist of assessing selected Analytical Performance Characteristics, such as those which are described in USP Chapter <1225>, to generate appropriate, relevant data rather than repeating the validation process.

Reference Standards

"Reference Standards provided by the United States Pharmacopeial Convention (USP Reference Standards, or RS) are highly characterized specimens reflective of specified drugs and foods (drug substances, biologics, excipients, dietary supplements, food ingredients, impurities, degradation products, reagents, and performance verification standards). When approved as suitable for use as comparison standards for documentary tests or assays (i.e., as a monograph component) in the United States Pharmacopeia (USP) or National Formulary (NF), USP RS also assume official status and legal recognition in the United States. Assessment of the suitability for use in other applications rests with the user. Official USP RS are primary standards in jurisdictions that so recognize them as such and, when appropriate, are calibrated relative to international reference materials such as those provided by the World Health Organization."

Lipinski's rule

A compound (molecule) is more likely to be membrane permeable and easily absorbed by the body if it matches the following criteria:

1. Its molecular weight is less than 500.
2. The compound's lipophilicity, expressed as logP (the logarithm of the partition coefficient between water and 1-octanol), is less than 5.
3. The number of hydrogen bond donors (usually the sum of hydroxyl and amine groups in a drug molecule) is less than 5.
4. The number of groups that can accept hydrogen bonds (estimated by the sum of oxygen and nitrogen atoms) is less than 10.

This rule applies only to absorption by passive diffusion of compounds through cell membranes; compounds that are actively transported through cell membranes by transporter proteins are exceptions to the rule. The majority of Active Pharmaceutical Ingredients (APIs) are thus relatively hydrophobic molecules and the reason why reversed phase HPLC has been the backbone of pharmaceutical analysis for over 30 years, and will continue to be. Roughly 10 % of all marketed drugs do not, however, follow Lipinski's rule. Notably many anti-virals and chemotherapeutic agents (anti-cancer drugs) are highly hydrophilic. More often than not, RP chromatography has been used also for these APIs by utilizing totally aqueous eluents or ion-pairing chromatography. The poor suitability of RP for polar APIs has, however, been acknowledged by the USP, and most of the pharmaceuticals on the 'Monograph Modernization List' are polar molecules. Titrations and other wet chemistry methods are often still used in assays of polar APIs in the USP, assays where HILIC would be the preferred method of choice. Although HILIC will not replace RP chromatography as the workhorse of pharmaceutical analysis, it will be featured more and more in official regulatory documents.

Pharmacopeial requirements

USP monograph modernization

The United States Pharmacopeia (USP) develops and publishes monographs and general chapters that provide public quality standards for drugs, excipients, and dietary supplements in the United States Pharmacopeia and the National Formulary (USP–NF). USP has started a global initiative to modernize many of the existing monographs and is actively seeking industry collaborators to assist in the development of such monographs. The direct participation of the pharmaceutical industry, and other interested stakeholders in this program are encouraged to assist in providing updated public standards to strengthen the protection of public health. USP intends to modernize these monographs as soon as possible; either by traditional submission from a stakeholder or from USP's internal laboratory efforts. For more information, please contact the Standards Acquisition Department at stacq@usp.org.

Merck Millipore has acted on this initiative, and we have developed a number of new methods for hydrophilic molecules and their related substances present in the 'Monograph Modernization List' issued by USP. A majority of the compounds present in the monograph modernization list "assay or related compound methods" are hydrophilic. A large number of currently official USP Monograph methods for hydrophilic compounds are still based on wet chemistry methods, mainly titrations or ill-suited reversed phase or ion-pairing methods. More than ten new methods have been submitted to illustrate that hydrophilic interaction liquid chromatography (HILIC) in general, and the bonded zwitterionic SeQuant® stationary phases in particular, are the ideal tools for assay analysis of polar and hydrophilic APIs and for profiling their related substances. At present, (March 2014) there is only one monograph which refers to HILIC as the technique and that is with an L3 (plain silica) column. However, there are also a number of monograph methods using HILIC conditions, but using normal phase columns like bare silica or amino columns for sugar separation. No modern dedicated HILIC columns have yet received an L classification (L number). This year, the Indian pharmacopeia (IP) introduces a monograph for Azacitidine using the SeQuant® ZIC®-HILIC column. Keep in mind that several older monograph methods based on RP chromatography are currently also part of the monograph modernization effort and that new methods are requested. More information can be found at the USP website, under "monograph modernization" (www.usp.org).

Further reading

www.merckmillipore.com/chromatography

Validation Protocols

Case Study 1: Clarithromycin USP assay method (USP37-NF32)

Solution A	4.76 g/L of monobasic potassium phosphate. Adjust with dilute phosphoric acid (1 in 10) or potassium hydroxide (45 % w/v) to a pH of 4.4.		
Solution B	Acetonitrile		
Gradient Program	Time [min]	Solution A [%]	Solution B [%]
	0 min	75 %	25 %
	32 min	40 %	60 %
	34 min	40 %	60 %
	36 min	75 %	25 %
	42 min	75 %	25 %
Diluent	Acetonitrile and water (1:1)		
Standard solution 1	1.5 mg/mL of USP Clarithromycin RS in acetonitrile and water (1:1 v/v). Dissolve first in acetonitrile, using 50 % of the final volume, and dilute with water to final volume.		
Standard solution 2	75 µg/mL of USP Clarithromycin RS from Standard solution 1 in Diluent		
Standard solution 3	1.5 mg/mL of USP Clarithromycin Identity RS in acetonitrile and water (1:1 v/v). Dissolve first in acetonitrile, using 50 % of the final volume, and dilute with water to volume.		
Sample Solution	1.5 mg/mL of Clarithromycin sample in acetonitrile and water (1:1 v/v). Dissolve first in acetonitrile, using 50 % of the final volume, and dilute with water to volume. Prepare 75 µg/mL test solution from the sample stock using diluents.		

Specificity test

1. Use a blank solution to show no interference
2. Use placebo to demonstrate the lack of interference from excipients
3. Use spiked samples to show that all known related substances are resolved from each other
4. Use stressed samples with about 10 to 20 % degradation are used to demonstrate the resolution among degradation products. Check the peak purity of the drug substance by using a photodiode array detector (PDA); e.g. purity angle is lower than the purity threshold.
5. Representative chromatograms should be provided with time scale and attenuation indicated

Pharmacopeial requirements

Linearity and range

From the calibration curve we can calculate the slope and from the slope we can calculate the limit of detection (LOD) and limit of quantitation (LOQ). In this case study, the 100 % concentration level corresponds to 75 ppm of USP Clarithromycin RS, see table.

Concentration [ppm]	% to concentration
112.5 ppm	150 %
90 ppm	120 %
75 ppm	100 %
60 ppm	80 %
37.5 ppm	50 %
18.75 ppm	25 %
7.5 ppm	10 %
3.75 ppm	5 %
0.75 ppm	1 %

LOQ (limit of quantitation) repeatability

Good repeatability at LOQ level is a requirement and average value, the deviation from mean and the relative standard deviation in % should be calculated from minimum 10 injections, see table.

Injection number	Area
1	
2	
3	
4	
5	
6	
7	
8	
9	
10	
Average	
Standard Deviation (SD)	
Relative Standard deviation (RSD) %	

Accuracy and Recovery

At least 3 different standard concentrations should be analyzed from final method sample concentrations; in this example and as in most cases for the LOQ level, 25 % and 50 % concentration level. A sample set can be designed in the following way (see table).

Recovery or accuracy can be calculated by the difference in area of pure sample and recovery standards and should be reported in percentage (%). The acceptable limit is 85-110 %.

Sample Concentration [ppm]	Recovery level	Area
75	0	
75	LOQ	
75	25 %	
75	50 %	
LOQ		
25 %		
50 %		

Precision

To determine the method precision multiple measurements of a defined sample should be carried out by the same analyst. A minimum of six (6) injections at the test concentration (6 times of a single batch) must be carried out, or to perform analysis at three (3) different concentration levels (80, 100, and 120 %) with three (3) repetitions each. The latter approach is a convenient way to also allow for method accuracy determination. For a monograph assay method the relative standard deviation should be better than 2.0 % (RSD <2.0 %).

Intermediate precision

Ruggedness should be determined by analysis of same sample on multiple days, with multiple analysts, and multiple equipments. Repeat the method precision by different analyst in different equipment using different column lots on different days (three different column lots are generally recommended). The RSD should be within same level as for the method precision. For a monograph assay method the relative standard deviation should be better than 2.0 % (RSD <2.0 %).

Robustness

To determine the method's capability to remain unaffected, small but deliberate variations in method parameters are carried out and where the following changes can be used as a recommendation.

1. Influence of variations of pH in a mobile phase (Changing buffer pH by +/- 0.2 units)
2. Influence of variations in mobile phase composition (Change in organic composition +/- 2.0 %)
3. Test different columns (different lots and/or suppliers)
4. Temperature
5. Flow rate (+/- 0.2 °C)

The acceptance criteria are that the system suitability test (SST) parameters should pass for all the conditions and all known and unknown impurities shall be well separated from each other.

Pharmacopeial requirements

In the present Clarithromycin monograph (USP37-NF32) there is no individual impurity specification. Instead, the Relative Retention Time (RRT) and Relative Response Factor (RRF) are given. From RRT we can identify the retention time of the impurity and from RRF we can calculate the percentage of impurities present in the sample. In the current monograph it says not more than (NMT) 0.4 % of any individual impurity and total impurities is NMT 3.5 %.

Case Study 2: Clarithromycin USP method – related substances (RS)

Solution A	4.76 g/L of monobasic potassium phosphate. Adjust with dilute phosphoric acid (1 in 10) or potassium hydroxide (45 % w/v) to a pH of 4.4.		
Solution B	Acetonitrile		
Gradient Program	Time [min]	Solution A [%]	Solution B [%]
	0 min	75 %	25 %
	32 min	40 %	60 %
	34 min	40 %	60 %
	36 min	75 %	25 %
	42 min	75 %	25 %
Diluent	Acetonitrile and water (1:1 v/v)		
Standard solution 1	1.5 mg/mL of USP Clarithromycin RS diluted in acetonitrile and water (1:1 v/v). Dissolve first in acetonitrile, using 50 % of the final volume, and dilute with water to final volume.		
Standard solution 2	75 µg/mL of USP Clarithromycin RS from Standard solution 1 in Diluent		
Standard solution 3	7.5 µg/mL of USP Clarithromycin RS from Standard solution 2 in Diluent		
Standard solution 4	1.5 mg/mL of USP Clarithromycin Identity RS diluted in acetonitrile and water (1:1 v/v). Dissolve first in acetonitrile, using 50 % of the final volume, and dilute with water to final volume.		
Sample Solution	1.5 mg/mL of Clarithromycin sample diluted in acetonitrile and water (1:1 v/v). Dissolve first in acetonitrile, using 50 % of the final volume, and dilute with water to final volume. Prepare 75 µg/mL test solution from the sample stock using diluents.		
Detector	UV 205 nm		
Column	100 x 4.6 mm; packing L1		
Column temperature	40°C		
Flow rate	1.1 mL/min		
Injection volume	10 µL		
Inject the following solutions during analysis	Diluent, Standard solution 2, Standard solution 3, Standard solution 4, and Sample solution. The RRT and RRF given for Clarithromycin and 16 Clarithromycin impurities are given in the table on the next page.		

Calculate the impurities using following formula:

$$\text{Result} = \frac{r_U}{r_S} \times \frac{C_S}{C_U} \times \frac{1}{F} \times 100$$

- r_U Peak response of any individual impurity RS (related substance) from the Sample solution
- r_S Peak response of Clarithromycin from Standard solution 3
- C_S Concentration of USP Clarithromycin RS in Standard solution 3 (mg/mL)
- C_U Concentration of Clarithromycin in the Sample solution (mg/mL)
- F Relative response factor as mentioned in table

Name	Relative Retention Time (RRT)	Relative Response Factor (RRF)
Clarithromycin impurity I	0.38	1.0
Clarithromycin impurity A (Clarithromycin F)	0.42	1.0
Clarithromycin impurity J	0.63	1.0
Clarithromycin impurity L	0.74	1.0
Clarithromycin impurity B	0.79	1.0
Clarithromycin impurity M	0.81	1.0
Clarithromycin impurity C	0.89	1.0
Clarithromycin impurity D	0.96	1.0
Clarithromycin	1.0	-
Clarithromycin impurity N	1.15	1.0
Clarithromycin related compound A	1.27	1.0
Clarithromycin impurity F	1.33	1.0
Clarithromycin impurity P	1.35	1.0
Clarithromycin impurity O	1.38	1.0
Clarithromycin impurity K	1.59	1.0
Clarithromycin impurity G	1.72	3.7
Clarithromycin impurity H	1.82	6.7

The validation of Clarithromycin related substances can be carried out using Standard Solution 3, setting the Clarithromycin concentration as 100 % concentration and follow the same procedure as described in the assay. The concentration of any individual impurity should not be more than 0.4 % and total impurities NMT 3.5 %. Using then Standard solution 1 (Clarithromycin concentration is 1.5 mg/mL or 1500 ppm, the 0.4 % level (of 1500 ppm) correspond to 6 ppm. If any individual impurity standard is available then validation should be carried out using a 6 ppm concentration as 100 % and repeat analysis as described in the assay.

Linearity and range

From the calibration curve we can calculate the slope and from the slope we can calculate the limit of detection (LOD) and limit of quantitation (LOQ). In this case study, the 100 % concentration level corresponds to 6 ppm of USP Clarithromycin RS.

Concentration [ppm]	% to concentration
9.0 ppm	150 %
7.5 ppm	125 %
6.0 ppm	100 %
4.8 ppm	80 %
3.0 ppm	50 %
1.5 ppm	25 %
0.6 ppm	10 %
0.3 ppm	5 %
0.06 ppm	1 %

LOQ repeatability, accuracy and recovery

For RS monograph method it possible to proceed as described in the assay method. The difference is that the relative standard deviation must not be more than 10 % for the related substances, and the concentration of Clarithromycin RS sample solutions are much lower, i.e. 6 ppm, LOQ, 25 % and 50 %

Column selection guide

This column selection guide will help to select the most suitable column for a specific application.

1 Selection by compound class

The most suitable column choice depends on the sample and also determined by the goals of the analyst. The analytes in the sample is the key when we choosing the column chemistry and mode of the separation. There one should pay attention to structure, solubility, log *P* value. Many compounds can be separated using different column materials. Nevertheless some column selectivity's are better suitable than others for certain compound classes. The table below shows a selection of compounds classes typically analysed by HPLC methods. The best suitable column selectivity is highlighted in **dark blue** in the table, a possible alternative column modification in **bright blue**.

Compound Class	Si	NH ₂	DIOL	CN	Phenyl	RP-8
A Aflatoxins						
Alcohols						
Aldehydes						
Aliphatic amines						
Alkaloids						
Amino acids						
Antibiotics						
Aromatic amines						
C Carboxylic acids						
Carotinoids						
E Enantiomers						
Esters						
Explosives						
F Fat soluble vitamins						
Fatty acids						
Flavonoids						
G Glycols						
I Inorganic ions						
K Ketones						
L Lipids						
M Methabolized steroids						
N Nitrosamines						
Nucleotides						
O Oils						
Organic phosphates						
P PAH						
PCB						
Peptides						
Pesticides						
Phenols						
Phospholipids						
Phthalates						
Preservatives						
Proteins						
S Steroids						
Sugar Alcohols						
Sugars						
Sulfonamides						
Sweeteners						
W Water soluble vitamins						

Column selection guide

2

Selection by chemical structure of the analyte with the log *P* value*

The selection of a most appropriate stationary phase very much depends on the chemical structure of the compounds to be separated. One important parameter, that describes the chemical structure of a compound is the log *P* value*. This table shows the log *P* value* of representative compounds of important analyte groups.

Analyte group	Example	Structure	log <i>P</i> value*
A	Aflatoxins	Aflatoxin G1	1.8
	Alcohols	Ethyl alcohol	-0.1
	Aldehydes	Benzaldehyde	1.5
	Alkaloids	Quinine	2.9
	Amino Acids	Aspartic acid	2
	Antibiotics	Amoxicillin	
Ranitidine			0.3
Aromatic amines	Aniline		0.9
C	Carboxylic acids	Glucuronic acid	-2.3
	Carotinoids	Canthaxanthin	11.4
D	Dyes	Rhodamine	4.4
E	Enantiomers	Thalidomide	0.3
	Essential oils	Safrole	3
	Esters	Atropine	1.8
F	Fat soluble vitamins	Retinol	5.7
	Fatty acids	Stearidonic acid	5.9
	Flavonoids	Quercetin	1.5



* log *P* value

The partition coefficient is a ratio of concentrations of un-ionized compound between the two solutions octanol and water. To measure the partition coefficient of ionizable solutes, the pH of the aqueous phase is adjusted such that the predominant form of the compound is un-ionized. The logarithm of the ratio of the concentrations of the un-ionized solute in the solvents is called log *P*. The log *P* value is also known as a measure of lipophilicity.

$$\log P_{\text{oct/wat}} = \log \left(\frac{[\text{solute}]_{\text{octanol}}}{[\text{solute}]_{\text{un-ionized water}}} \right)$$

Column selection guide

- Selection by compound class | 1
- Selection by chemical structure of the analyte | 2
- Selection by stationary phase | 3
- Selection by sorbent specifications | 4
- Selection by specific chromatographic needs | 5
- Selection by column dimension | 6
- Selection by USP classification | 7

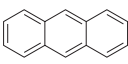
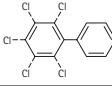
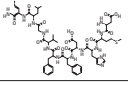
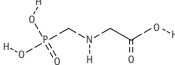
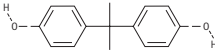
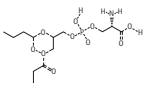
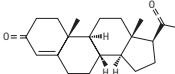
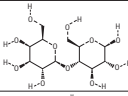
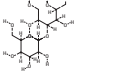
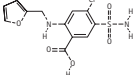
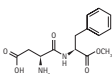
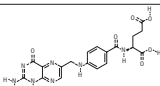
Analyte group	Example	Structure	log P value*
G			
Glycols	Ethylene glycol		-1.4
I			
Inorganic ions	Chloride	Cl ⁻	0.8
K			
Ketones	Cyclohexanone		0.8
N			
Nitrosamines	N-Nitrosodimethylamine		-0.6
P			
PAH	Anthracene		4.4
PCB	Pentachlorobiphenyl		7.3
Peptides	Neurokinin B		-1.6
Pesticides	Glyphosate		-4.6
Phenols	Bisphenol A		2.2
Phospholipids	Phosphatidylserine		-3.5
S			
Steroids	Progesterone		3.9
Sugars	Lactose		-4.7
Sugar Alcohols	Maltitol		-5.2
Sulfonamides	Furosemide		2
Sweeteners	Aspartame		-2.7
W			
Water soluble vitamins	Folic Acid		-1.1

Please have a look on the next page to select the column which suits your application best.

3 Selection by stationary phase

If a compound is mainly of hydrophobic character with a positive log *P* value, then the use of a reversed phase column is advisable. Thus please select a C18 or C8 bonded phase for good retention and resolution. For low/medium polarity analytes, normal phase HPLC or HILIC are viable techniques, while HILIC, and particularly ZIC®-HILIC is the most suitable separation technique for polar and hydrophilic compounds. If a chiral resolution is the method goal, then a suitable chiral column should be chosen.

Stationary phase	USP code	Monolithic columns Type B	Page	Method	
hydrophobic	L1	Chromolith® RP-18e	214	LC-MS Fast HPLC	
		Chromolith® HR RP-18e	214		
		Chromolith® CapRod® RP-18e	201	LC-MS	
	RP-18	L1			
		L1	RP-18 polar endcapped		
			RP-8 endcapped		
		L7	Chromolith® RP-8e	230	LC-MS Fast HPLC
	hydrophilic	L7	Chromolith® CapRod® RP-8e	201	LC-MS
			RP-8		
		L29			
L11		Chromolith® Phenyl	232	LC-MS Fast HPLC	
L10		Chromolith® CN	234		
L20		Chromolith® DIOL	236	Fast HPLC	
L3		Chromolith® Si	238	Fast HPLC	
L8	Chromolith® NH ₂	240	Fast HPLC		
ZIC®-HILIC					
Chiral modifications		L45			

e = endcapped | HR = High Resolution

Column selection guide

- Selection by compound class | 1
- Selection by chemical structure of the analyte | 2
- Selection by stationary phase | 3**
- Selection by sorbent specifications | 4
- Selection by specific chromatographic needs | 5
- Selection by column dimension | 6
- Selection by USP classification | 7

High purity silica particles Type B	Page	Method	Conventional silica particles Type A	Page	non silica based materials	Page	Method
Purospher® STAR RP-18e	269	LC-MS UHPLC	Superspher® RP-18e	309			
Purospher® RP-18e	302		LiChrospher® RP-18e	314			
Purospher® RP-18 HC	306		LiChrospher® RP-18	314			
			Superspher® RP-18	309			
			LiChrospher® PAH	322			
			LiChrospher® WP 300	320			
			LiChrosorb® RP-18	343			
Purospher® RP-18	304						
Purospher® STAR RP-8e	283	LC-MS UHPLC	LiChrospher® RP-8e	325			
			Superspher® RP-8e	309			
			LiChrospher® RP-8	325			
			LiChrospher® 60 RP-select B	329			
			Superspher® RP-8	309			
			LiChrosorb® RP-8	343			
					Aluspher® RP-select B	346	
Purospher® STAR Phenyl	286	LC-MS UHPLC					
			LiChrospher® 100 CN	334			
			LiChrospher® 100 DIOL	338			
Purospher® STAR Si	289	LC-MS	LiChrospher® Si 60 and Si 100	340			
			Superspher® Si 60	309			
Purospher® STAR NH ₂	289		LiChrospher® 100 NH ₂	336			
ZIC®-HILIC	354				ZIC®-pHILIC	362	LC-MS
ZIC®-cHILIC	359						
ChiraDex®				364			

Column selection guide

4

Selection by sorbent specifications

A list of specification of column sorbents gives detailed information to all Merck Millipore analytical HPLC stationary phases.

Sorbent	USP Listing	Silica type *	Sorbent characteristic	Particle size	pH stability
hydrophobic [reversed-phase chromatography]					
Chromolith® HighResolution RP-18 endcapped	L1	B mono.	with Octadecyl modification and endcapping	monolithic	2-7.5
Chromolith® RP-18 endcapped	L1	B mono.	with Octadecyl modification and endcapping	monolithic	2-7.5
Chromolith® RP-8 endcapped	L7	B mono.	with Octyl modification and endcapping	monolithic	2-7.5
Chromolith® Phenyl	L11	B mono.	with Phenyl modification and endcapping	monolithic	2-7.5
LiChrospher®/Superspher® RP-18	L1	A	with Octadecyl modification	4, 5, 10 µm	2-7.5
LiChrospher®/Superspher® RP-18 endcapped	L1	A	with Octadecyl modification and endcapping	4, 5, 10 µm	2-7.5
LiChrospher®/Superspher® RP-8	L7	A	with Octyl modification	4, 5, 10 µm	2-7.5
LiChrospher®/Superspher® RP-8 endcapped	L7	A	with Octyl modification and endcapping	4, 5, 10 µm	2-7.5
LiChrospher®/Superspher® RP-select B	L7	A	with Octyl modification, base deactivated and endcapping	4, 5, 10 µm	2-7.5
Purospher® RP-18	L1	B spher.	with Octadecyl modification and polar endcapping	5 µm	2-8
Purospher® RP-18 endcapped	L1	B spher.	with Octadecyl modification and endcapping	5 µm	2-8
Purospher® RP-18 HC	L1	B spher.	with Octadecyl modification	5 µm	2-7.5
Purospher® STAR RP-18 endcapped	L1	B spher.	with polymeric Octadecyl modification and endcapping	2, 3, 5 µm	1.5-10.5
Purospher® STAR RP-8 endcapped	L7	B spher.	with Octyl modification and endcapping	2, 3, 5 µm	1.5-10.5
Purospher® STAR Phenyl	L11	B spher.	with Phenyl modification and endcapping	2, 3, 5 µm	1.5-10.5
hydrophilic [normal-phase chromatography and hydrophilic interaction chromatography HILIC]					
Chromolith® CN	L10	B mono.	with Cyano bonding	monolithic	2-7.5
Chromolith® DIOL	L20	B mono.	with Diol bonding	monolithic	2-7.5
Chromolith® NH ₂	L8	B mono.	with amino bonding	monolithic	2-7.5
Chromolith® Si	L3	B mono.	unbonded	monolithic	2-7.5
LiChrospher®/Superspher® CN	L10	A	with Cyano bonding	5, 10 µm	2-7.5
LiChrospher®/Superspher® DIOL	L20	A	with Diol bonding	5, 10 µm	2-7.5
LiChrospher®/Superspher® NH ₂	L8	A	with amino bonding	5, 10 µm	2-7.5
LiChrospher®/Superspher® Si	L3	A	unbonded	4, 5, 10 µm	2-7.5
Purospher® STAR NH ₂	L8	B spher.	with amino bonding	5 µm	2-7.5
Purospher® STAR Si	L3	B spher.	unbonded	5 µm	2-7.5
SeQuant® ZIC®-HILIC	-	B spher.	with zwitterionic bonding Sulfobetaine	3.5, 5 µm	2-7.5
SeQuant® ZIC®-cHILIC	-	B spher.	with zwitterionic bonding Phosphorylcholine	3 µm	2-7.5
SeQuant® ZIC®-pHILIC	-	-	Spherical polymeric particles with zwitterionic bonding Sulfobetaine	5 µm	2-12

Silica type * | A = Conventional spherical silica particles [Type A] | B mono. = High-purity monolithic silica [Type B] | B spher. = High-purity spherical silica particles [Type B]

Column selection guide

- Selection by compound class | 1
- Selection by chemical structure of the analyte | 2
- Selection by stationary phase | 3
- Selection by sorbent specifications | 4**
- Selection by specific chromatographic needs | 5
- Selection by column dimension | 6
- Selection by USP classification | 7

Matrix tolerability	MS suitability	Use in UHPLC instruments	Application
high	high	high	Fast and robust high performance separation of hydrophobic to medium polar compounds at low back-pressure
very high	high	high	Fast and robust separation of hydrophobic to medium polar compounds at low column back-pressure
very high	high	high	Fast and robust separation of less hydrophobic compounds at low pressure
very high	high	high	Fast and robust separation of aromatic compounds at low pressure
medium – high	low – medium	low – medium	Separation of less hydrophobic compounds
medium – high	low – medium	low – medium	Medium to less polar compounds with ionizable functional groups
medium – high	low – medium	low – medium	Separation of less hydrophobic compounds
medium – high	low – medium	low – medium	Separation of less hydrophobic compounds
medium – high	low – medium	low – medium	Separation of less hydrophobic and basic compounds
medium	medium	medium	Very good for strong bases, polar endcapped (not suitable for separation of strong acids)
medium	high	medium	Separation of hydrophobic to medium polar neutral, acidic, basic or chelating compounds
medium	high	medium	Very good suitability for separation of polar, non-basic compounds e.g. explosives
low – medium	high	high	Tailing-free and high performance separation of hydrophobic to medium polar neutral, acidic, basic or chelating compounds
low – medium	high	high	High performance separation of less hydrophobic and basic compounds with excellent peak shape
low – medium	high	high	Enhanced selectivity for separation of aromatic compounds
very high	high	high	Fast and robust separation of polar compounds with normal-phase or reversed-phase chromatography
very high	high	high	Fast and robust separation of polar compounds with normal-phase or HILIC chromatography
very high	low – medium	high	Fast and robust separation of carbohydrates or HILIC chromatography
very high	high	high	Fast and robust separation of polar compounds with normal-phase or HILIC chromatography
medium – high	low – medium	low – medium	Provides polar and hydrophobic properties for normal-phase and reversed-phase chromatography
medium – high	low – medium	low – medium	Provides polar and hydrophobic properties for normal-phase chromatography or HILIC chromatography. In addition suitable for exclusion chromatography.
medium – high	low	low	Separation of carbohydrates
medium – high	low – medium	low – medium	Separation of polar compounds with normal-phase or HILIC chromatography
medium	low – medium	low – medium	High performance separation of carbohydrates or HILIC chromatography
medium	high	high	Separation of polar compounds with normal-phase or HILIC chromatography
medium	high	high	Excellent and robust separation of polar and hydrophilic compounds in HILIC chromatography
medium	high	high	Excellent and robust separation of polar and hydrophilic compounds in HILIC chromatography
medium	high	high	For extra difficult separations of polar and hydrophilic compounds at extended pH range in HILIC mode chromatography

5 Selection by specific chromatographic needs

Prioritizing specific needs helps to select the best suitable column material for different chromatographic demands. Depending on the sample analyte, the sample matrix, the lab environment (e.g. instrumentation) and the separation goal, the best column choice can be very different from task to task. Of course, the selection of the column chemistry is the first step. Many different selectivity's are available based on different column materials. Nevertheless, RP-18 is still the most widely used column modification.

The table below is listing a selection of typical specific needs in HPLC on column materials with RP-18 modifications. The ranking is from 1 (lowest ranking) to 5 (highest ranking).

Particle size [µm]	LiChrosorb® RP-18		Superspher®/LiChrospher RP-18 / RP18e			Purospher® STAR RP-18e			Chromolith® RP-18e HR RP-18e	
	5 µm	10 µm	4 µm	5 µm	10 µm	2 µm	3 µm	5 µm	monolithic	
Separation efficiency *	2	1	3	2	1	5	4	3	3	5
Peak symmetry	3	3	3	3	3	5	5	5	3	4
Lifetime (for dirty samples)	3	4	2	3	4	1	2	3	5	4
Lifetime (based on mechanical stability)	3	3	3	3	3	4	4	3	5	5
Lifetime (based on chemical stability)	5	5	5	5	5	5	5	5	5	5
100 % aqueous mobile phase compatibility	1	1	1	1	1	5	5	5	1	1
pH stability (range) **	1	1	1	1	1	4	4	4	1	2
Low Bleeding (for MS)	2	2	2	2	2	4	4	4	4	5
Reproducibility (Column-to-Column)	3	3	4	5	4	4	4	5	3	4
Low column back-pressure	3	4	2	3	4	1	2	3	5	4
High flow rates	3	4	2	3	4	1	2	3	5	4
Loadability	5	5	5	5	5	5	5	5	4	4
Quantitation	3	3	3	3	3	5	5	5	4	5
Sample throughput	3	2	3	3	2	5	5	3	5	5
Compatibility with UHPLC instruments	1	1	1	1	1	5	5	1	4	1
Temperature ***	4	4	4	4	4	5	5	5	3	3
Up-Scalability (above 4.6 mm i.d.)	5	5	1	5	5	1	1	4	5	1
Down-Scalability (to below 1 mm i.d.)	1	1	1	1	1	1	1	1	5	3

Summarizing

Purospher® STAR RP-18 endcapped is the most versatile HPLC column material providing highest flexibility in R&D and reliability in QC from excellent peak symmetry, high performance and pH stability.

Chromolith® HighResolution RP-18 endcapped columns provide highest efficiency without high back-pressure, reduced need for sample preparation and increased lifetime with dirty samples.

The best alternatives to RP column selectivities for separating polar and hydrophilic compounds are **SeQuant® ZIC®-HILIC** and **ZIC®-cHILIC HPLC** columns, providing the highest performance and outstanding LC/MC compatibility.

Criteria – Ranking:

* Separation efficiency	** pH stability (range)	*** Temperature (max.)
1 <50,000 N/m	1 2 – 7.5	1 30°C
2 50,000 – 75,000 N/m	2 2 – 8	2 40°C
3 75,001 – 100,000 N/m	3 1.5 – 9	3 50°C
4 100,001 – 150,000 N/m	4 1.5 – 10.5	4 60°C
5 >150,000 N/m	5 1.5 – 12	5 70°C

Column selection guide

- 1 | Selection by compound class
- 2 | Selection by chemical structure of the analyte
- 3 | Selection by stationary phase
- 4 | Selection by sorbent specifications
- 5 | Selection by specific chromatographic needs
- 6 | Selection by column dimension**
- 7 | Selection by USP classification

6

Selection by column dimension

Depending on the scale of a separation and/or a needed separation efficiency of a separation, a column dimension specified by column inner diameter (i.d.) and column length has to be chosen.

Column dimension [length x i.d. in mm]	Application	Reason
4 x 4 5 x 2 / 3 / 4.6 10 x 4.6 / 10 / 25	Guard-column	Protection from mechanical contamination Sample contaminated to low extent
25 x 4	Precolumn	High capacity precolumn
30 x 2 / 2.1 / 3 / 4 55 x 2 / 2.1 / 3 / 4 75 x 4	Method development Rapid HPLC and UHPLC (if pressure stable)	Short retention time Rapid equilibration Low solvent consumption (small i.d.) Low pressure drop
100 x 2.1 125 x 2 / 3 150 x 2.1 / 3	High detection sensitivity (mass selectivity)	Semi-micro column for low injection volumes and low peak dispersion Low solvent consumption
100 x 4.6 125 x 4 / 4.6 150 x 4.6	Standard column	Adequate performance for most applications (average performance 8000 – 10000 N/column)
250 x 2 / 2.1 / 3	High detection sensitivity High performance separation	Semi-micro column for low injection volumes and low peak dispersion Low solvent consumption For complex samples
250 x 4 / 4.6	High performance separation	For very complex samples
250 x 10	Semi-preparative	For mg quantities of pure substance on lab scale
250 x 25	Preparative	For g quantities of pure substance

Guidelines for typical flow rates and orientation values for the loading capacities of analytical and semi-preparative columns

Column dimensions [length x i.d. in mm]	Typical flow rates	Sample amount	Sample volume
150 x 1	0.06 mL/min	≈ 0.05 mg	0.05 – 1 µL
250 x 2	0.25 mL/min	≈ 0.2 mg	0.2 – 5 µL
250 x 3	0.6 mL/min	≈ 1 mg	1 – 20 µL
250 x 4	1 mL/min	≈ 5 mg	5 – 80 µL
250 x 10	6 mL/min	≈ 30 mg	30 – 500 µL
250 x 25	39 mL/min	≈ 200 mg	200 – 3000 µL

7

Selection by USP classification

The following list describes the main USP classes and the corresponding Merck Millipore stationary phases. B is a base-compatible C-8 phase.

L1	Octadecylsilane chemically bonded to porous silica or ceramic micro-particles, 1.5 to 10 µm in diameter, or a monolithic rod	
	Product	Page
	Chromolith® HighResolution RP-18 endcapped	214
	Chromolith® RP-18 endcapped	214
	LiChrosorb® RP-18 (5 µm, 7 µm, 10 µm)	343
	LiChrospher® PAH (5 µm)	322
	LiChrospher® 100 RP-18 (5 µm, 10 µm)	314
	Purospher® RP-18 (5 µm)	304
	Purospher® RP-18 endcapped (5 µm)	302
	Purospher® STAR RP-18 endcapped (2 µm, 3 µm, 5 µm)	269
L3	Porous silica particles, 1.5 – 10 µm in diameter, or a monolithic rod.	
	Product	Page
	Chromolith® Si	238
	LiChrosorb® Si 60 (5 µm, 10 µm)	343
	LiChrospher® Si 60 (5 µm, 10 µm)	340
	LiChrospher® Si 100	340
	Purospher® STAR Si (5 µm)	289
L7	Octylsilane, chemically bound to porous silica of 5 – 10 µm diameter	
	Product	Page
	Chromolith® RP-8 endcapped	230
	LiChrosorb® RP-8 (5 µm, 7 µm, 10 µm)	343
	LiChrosorb® RP-select B (5 µm)	343
	LiChrospher® RP-8 (5 µm, 10 µm)	325
	Purospher® STAR RP-8 endcapped (3 µm, 5 µm)	283
L8	Aminopropyl silane groups on porous silica of 5 – 10 µm diameter	
	Product	Page
	Chromolith® NH ₂	240
	Purospher® STAR NH ₂ (5 µm)	289
L10	Cyano groups bound to porous silica of 3 – 10 µm diameter	
	Product	Page
	Chromolith® CN	234
	LiChrospher® 100 CN (5 µm, 10 µm)	334
L11	Phenyl groups bound to porous silica	
	Product	Page
	Chromolith® Phenyl	232
L20	Dihydroxypropane groups chemically bound to silica of 5 – 10 µm diameter	
	Product	Page
	LiChrospher® 100 DIOL (5 µm, 10 µm)	338
L29	Alumina-based polybutadiene spherical particles 5 µm	
	Product	Page
L45	Beta cyclodextrin bonded to porous silica particles 5 to 10 µm in diameter	
	Product	Page

Chromolith®

Speed and performance based on revolutionary monolithic silica technology

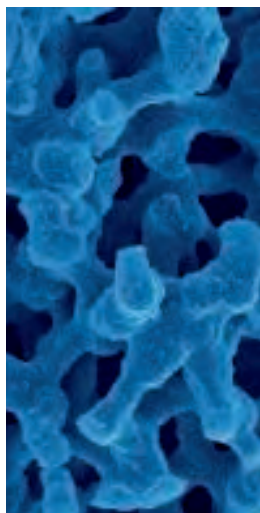

Chromolith® HPLC columns provide excellent separations in a fraction of the time that a standard particulate column will take, because they are made from highly porous monolithic rods of silica with a revolutionary bimodal pore structure. **The column is no longer packed with small particles but consists of a single piece of high-purity monolithic silica gel.** The Chromolith® HPLC columns are available as "ready-to-use columns" (no cartridge holder required).

Chromolith® HPLC columns are manufactured from the same metal-free silanes from which high purity particulate silica columns (eg. Purospher®) are made. This minimizes the time required to adapt an existing method from a particulate column to a Chromolith® column. **Longer Lifetime and Less Matrix-Sensitivity with biological samples** are advantages of Chromolith® columns reported by customers. Because of the rigid monolithic silica structure, column lifetime is substantially enhanced.

Speed of analysis and lower operating pressure are the most important benefits of Chromolith® columns. Compared with a 5 µm particulate column, the speed of analysis can be typically 4-times faster. Alternatively, multiple columns can be coupled together to give high efficiencies at normal pressures! With Chromolith® HPLC columns, flow gradient methods are particularly attractive.



Chromolith® CapRod®

Monolithic capillary

Chromolith® CapRod® is a capillary column which combines the speed of monolithic silica technology with the sensitivity of nano-LC, hence enabling new productivity levels for high throughput, high sensitive proteomics-LC applications to be achieved. The unique combination of two different types of pores (large macropores to allow rapid transit of the eluent and small mesopores to create a large surface area) means that Chromolith® CapRod® provides excellent separations in a fraction of the time required by conventional particulate capillary columns. Compared to particulate capillary columns, Chromolith® CapRod® capillaries show a better performance as shown by optimal resolution (narrow peak widths), increased productivity like sample throughput and prolonged column life-time. Finally, column length is less limited, compared to any other type of column. The capillaries can even be bent to a certain degree in order to fit optimally in any LC configuration and instrument. Chromolith® CapRod® monolithic capillary columns are designed to work with various Nano or Capillary LC systems, providing highest efficiencies and performance when coupled to mass spectrometers, both on-line (ESI, nanospray) and off-line (MALDI).

In contrast to classical micro-particulate sorbents, Chromolith® CapRod® columns can be operated at comparatively high flow rates without loss of performance and other limitations due to column back-pressure. Flow rates can be dramatically increased without compromising resolution. Separations can be achieved at 1-3 µL/min compared to 200-400 nL/min for conventional media on a standard 100 µm LC capillary column. A trapping capillary is also being offered in order to protect the precious separation column and to optimize the separation efficiency when using complex biological samples.

Monolithic capillary columns have become increasingly important in the separation of biomolecules, especially in combination with mass spectrometry. As compared to particulate columns, monolithic capillaries do not require frits and have a much lower tendency to clog, thus allowing higher flow rates improving speed and quality of biomolecule characterization. The strong growing interest for µ- and nano- HPLC now will be excellently served with our offering of wide range monolithic silica capillaries differing in inner diameter (50 µm, 100 µm and 200 µm), bonded phase (C8, C18), pore structure (standard and high resolution) and length (5, 15 and 30 cm).

Specifications of Chromolith® CapRod®

Sorbent characteristics	Monolithic silica gel
Column inner diameter	0.05 (50 µm), 0.1 mm (100 µm) and 0.2 mm (200 µm)
Column length	150 mm, 300 mm
Surface modification	RP-8 endcapped, RP-18 endcapped
Macropore size	2 µm (1 µm for "HighResolution" products)
Mesopore size	13 nm
Surface area	300 m ² /g

- ▶ **Chromolith® RP-18 endcapped** Chromolith® RP-18 endcapped columns are the fastest C18 columns in the world. **page 214**
- ▶ **Chromolith® RP-8 endcapped** **page 230**
- ▶ **Chromolith® Si** **page 238**
- ▶ **Chromolith® guard cartridges and cartridge kit** **page 243**
- ▶ **Chromolith® column coupler** **page 248**
- ▶ **Chromolith® SemiPrep** Perfect scale-up from analytical to preparative LC **page 250**
- ▶ **Chromolith® Prep** Chromolith® – increase in speed, efficiency and productivity **page 254**

Recommended use and flow rate ranges

Recommended use	RP-18e 150 x 0.05	RP-8e 150 x 0.1	RP-8e 50 x 0.1 Trap	RP-18e 50 x 0.1 Trap	RP-18e 150 x 0.1	RP-18e 300 x 0.1	RP-18e 150 x 0.1 HR	RP-18e 50 x 0.2 Trap	RP-18e 150 x 0.2	RP-18e 150 x 0.2 HR
Separation of small molecules	•			•	•	•	•		•	•
Separation of peptides	•	•	•	•	•	•	•		•	•
Separation of proteins		•	•							
Micro ESI		•			•	•	•	•	•	•
Nano ESI	•	•			•	•	•	•		
High Resolution							•			•
Flow rates [$\mu\text{L}/\text{min}$]	0.2 – 0.8	0.4 – 3	1 – 10	1 – 10	0.4 – 3	0.2 – 1.5	0.1 – 0.4	10 – 50	5 – 20	0.5 – 2
Max. back-pressure [bar]	200	200	200	200	200	200	218	218	218	218

Ordering information – Chromolith® CapRod®

Product	Ordering No.	Dimension length	Dimension i.d.	Contents of one package
Chromolith® CapRod® RP-18e	1.50403.0001	150 mm	0.05 mm	1 Capillary, Sleeves, Fittings, Certificate of Analysis
Chromolith® CapRod® RP-8e Trap	1.52031.0001	50 mm	0.1 mm	1 Capillary
Chromolith® CapRod® RP-8e	1.50400.0001	150 mm	0.1 mm	1 Capillary, Sleeves, Fittings, Certificate of Analysis
Chromolith® CapRod® RP-18e Trap	1.50426.0001	50 mm	0.1 mm	1 Capillary
Chromolith® CapRod® RP-18e	1.50402.0001	150 mm	0.1 mm	1 Capillary, Sleeves, Fittings, Certificate of Analysis
Chromolith® CapRod® RP-18e	1.50424.0001	300 mm	0.1 mm	1 Capillary, Sleeves, Fittings, Certificate of Analysis
Chromolith® CapRod® RP-18e HighResolution	1.50404.0001	150 mm	0.1 mm	1 Capillary, Sleeves, Fittings, Certificate of Analysis
Chromolith® CapRod® RP-18e Trap	1.50409.0001	50 mm	0.2 mm	1 Capillary
Chromolith® CapRod® RP-18e	1.50405.0001	150 mm	0.2 mm	1 Capillary, Sleeves, Fittings, Certificate of Analysis
Chromolith® CapRod® RP-18e HighResolution	1.50407.0001	150 mm	0.2 mm	1 Capillary, Sleeves, Fittings, Certificate of Analysis



CapRod® column

The outer diameter of the capillary is 360 nm.

Characterization of Chromolith® CapRod®

The new Chromolith® CapRod® capillary column is designed for the efficient and selective separation of peptides and protein digests and is especially suited for capillary or nano-LC. Based on proprietary sol-gel technology, highly porous monolithic rods of pure silica with a unique pore structure are formed. Each column has a macropore and a mesopore structure which gives it very high porosity. The macropores form a network of pores through which the eluent can rapidly flow, hence dramatically reducing separation time. The mesopores form the fine pore structure of the capillary interior and create a very large surface area onto which adsorption of the target molecule can occur. The Chromolith® CapRod® analytical capillary columns are supplied complete with sleeves and standard 1/16" PEEK fittings to allow for direct coupling to a UV detector or mass spectrometer.

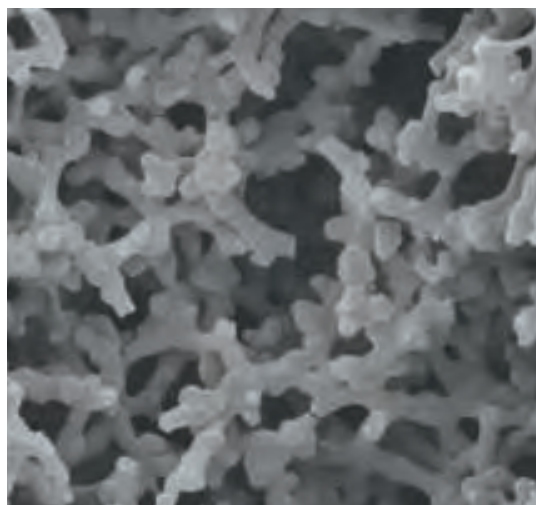

The cross section shows the bimodal pore structure of Chromolith® CapRod® with macropores at ~2 µm (1 µm for "HighResolution" products) and mesopores at 13 nm.

Separation example on Chromolith® CapRod® Steroids

Column	Chromolith® CapRod® RP-8e 150 x 0.1 mm
Mobile phase	A: Water + 0.1 % formic acid B: Acetonitrile + 0.1 % formic acid
Gradient	3 min 12 % B to 27 % B 1 min hold 11 min 27 % B to 90 % B 5 min hold followed with 25 min re-equilibration
Flow rate	2 µL/min (0.2 mL/min, 1:100 split)
Detection	UV 240 nm
Cell	45 nL
Temperature	25°C
Diluent	ACN/H ₂ O
Injection volume	1.0 µL
Pressure drop	95 bar
Sample	1. Fluoxymesterone 2. Boldenone 3. Methandrostenolone 4. Testosterone 5. Methyltestosterone 6. Boldenone-Acetate 7. Testosterone-Acetate 8. Nandrolone-Propionate 9. Testosterone-Propionate 10. Nandrolone-Phenylpropionate 11. Testosterone-Isocaproate

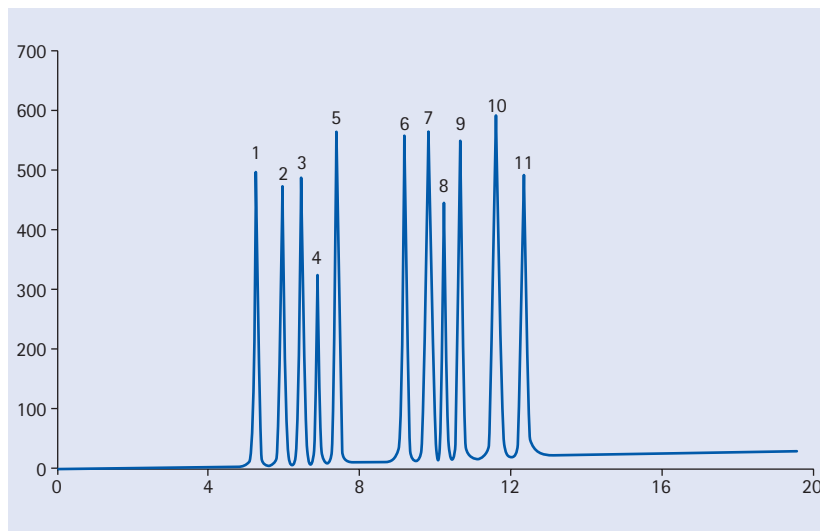

Separation examples on Chromolith® CapRod® (monolithic silica capillary column), Trypsin digested Cytochrom C

Column	Chromolith® CapRod® RP-18e 150 mm x 100 µm
Mobile phase	A: 0.1 % formic acid in 2 % acetonitrile B: 0.08 % formic acid in 80 % acetonitrile
Gradient	98 % to 60 % A in 35 minutes
Flow rate	2 µL/min
Injection volume	0.1 µL
Sample	Trypsin digested Cytochrom C (1mg/mL)

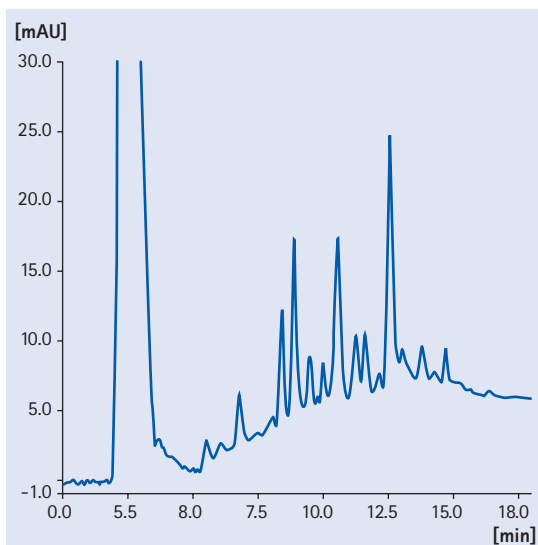

Column	Chromolith® CapRod® RP-18e HighResolution 150 mm x 100 µm
Mobile phase	A: 0.1 % formic acid in 2 % acetonitrile B: 0.08 % formic acid in 80 % acetonitrile
Gradient	98 % to 60 % A in 35 minutes
Flow rate	400 nL/min
Injection volume	0.1 µL
Sample	Trypsin digested Cytochrom C (1mg/mL)

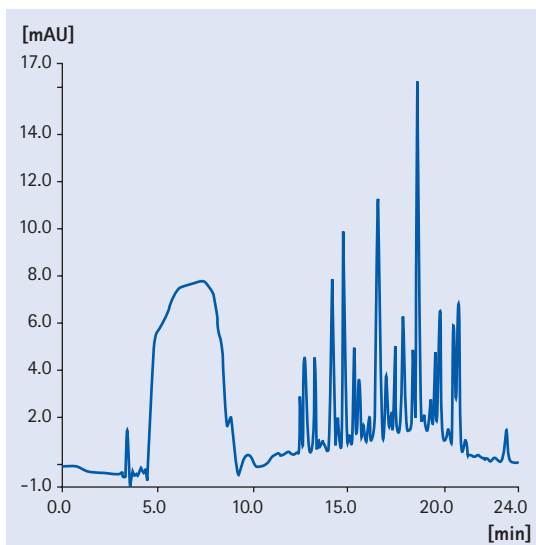

Sudan dyes and capsaicinoids from hot sauce extraction

Column	Chromolith® CapRod® RP-18e 150-0.1 mm
Mobile phase	A: Water + 0.1 % formic acid B: Acetonitrile + 0.1 % formic acid
Gradient	35 % to 95 % B in 12 minutes
Flow rate	1.24 µL/min
Pressure drop	80 bar (1160 psi)
Detection	nano-ESI(+) 100-600 m/z
Temperature	ambient
Injection volume	2.5 nL
Sample	Sudan dyes and capsaicinoids (see table)

No.	Compound	RT [min]	[g/mol]	[m/z]
1	Nordihydrocapsaicin	4.05	293.20	294.11
2	Capsaicin	4.23	305.20	306.18
3	Dihydrocapsaicin	4.90	307.21	308.19
4	Homodihydrocapsaicin	5.73	321.23	322.11
5	Para red	7.02	293.08	294.05
6	Sudan I	7.55	248.09	249.05
7	Sudan II	9.33	276.13	277.10
8	Sudan III	10.74	352.13	353.11
9	Sudan IV	12.11	380.16	381.21

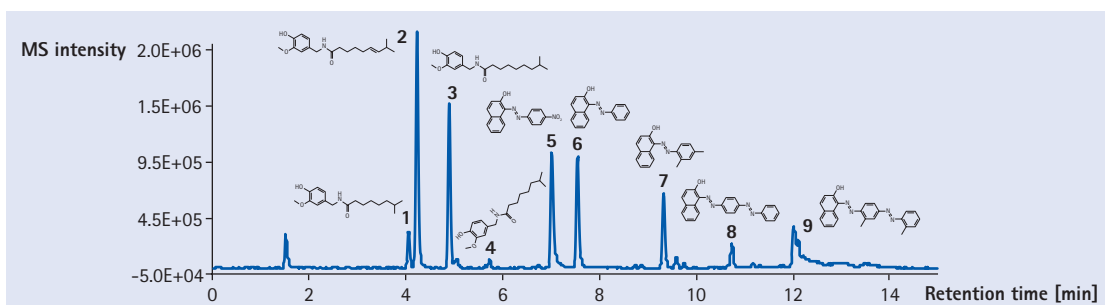

Separation examples on Chromolith® CapRod® Small molecules

Column	Chromolith® CapRod® RP-18e 300 x 0.1 mm
Mobile phase	A: Water ($\epsilon^\circ = \gg 1$; $\eta = 1.00$) B: Acetonitrile ($\epsilon^\circ = 0.50$; $\eta = 0.37$)
Gradient	70 % B isocratic
Flow rate	300 $\mu\text{L}/\text{min}$
Pressure	51 bar
Detection	nano LC, mic-split (1:6) + 2nd split, 210 nm, 5 Hz
Temperature	ambient
Injection volume	3 μL
Sample	1. Uracil 2. Toluene 3. Ethylbenzene 4. Propylbenzene 5. Butylbenzene 6. Pentylbenzene 7. Hexylbenzene 1 μL inject (full loop mode)

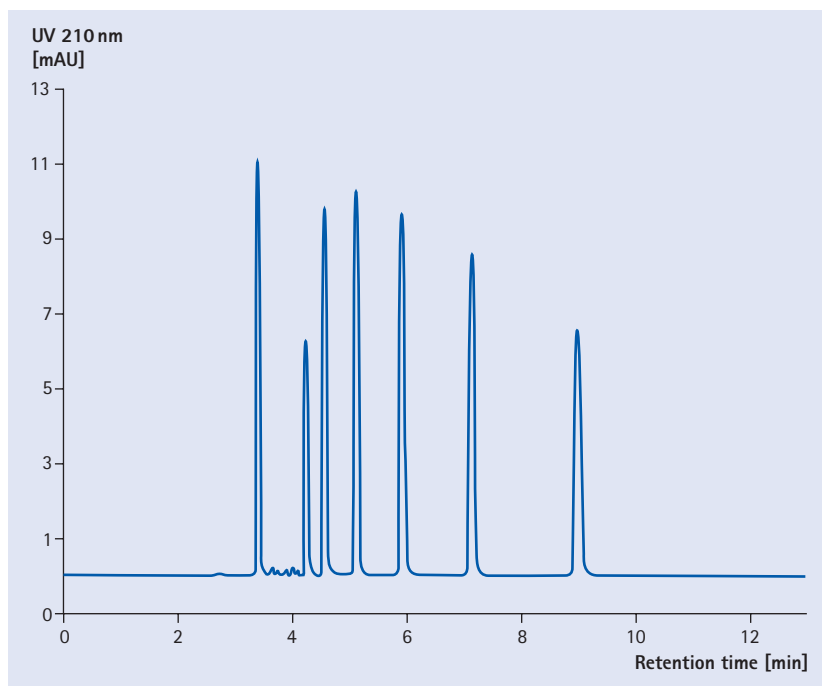

Separation repeatability for biological compounds

Excellent repeatability / reproducibility on monolithic silica capillaries. Long lifetime of capillary due to high mechanical stability of porous silica network.

Column	Chromolith® CapRod®, RP-18e 150 mm x 0.1 mm
Mobile phase	A: 2 % ACN, 0.1 % formic acid B: 80 % ACN, 0.08 % formic acid
Gradient	2 % to 40 % B in 35 min
Flow rate	3 $\mu\text{L}/\text{min}$
Sample	Cytochrom C digest

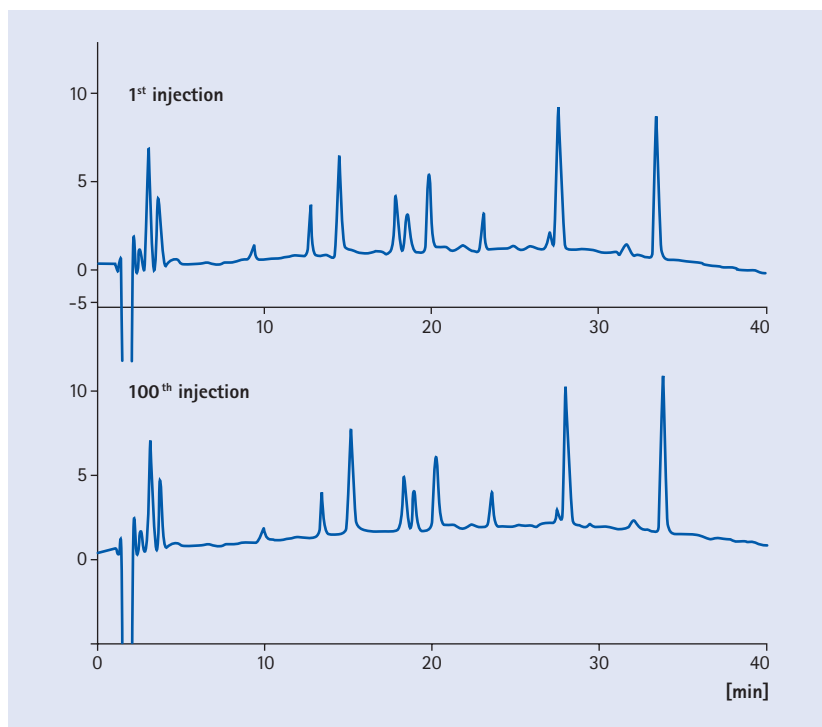

Chromolith® HPLC columns

Speed and performance in monolithic form

Chromolith® HPLC columns provide excellent separations in a fraction of the time that a standard particulate column will take, because they are made from highly porous monolithic rods of silica with a revolutionary bimodal pore structure. The column is no longer packed with small particles but consists of a single piece of high-purity polymeric silica gel.

This revolutionary bimodal pore structure provides a unique combination of macropores and mesopores.

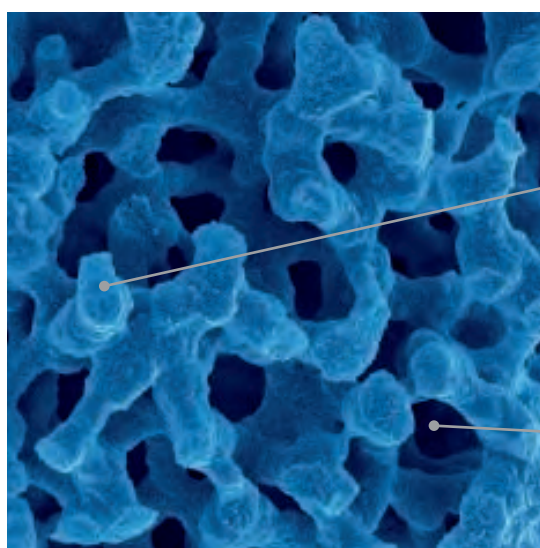

Mesopores: 13 nm

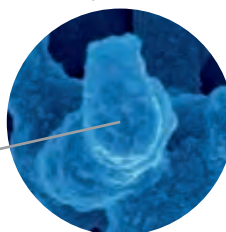

The mesopores form the fine porous structure (average pore size 13 nm) and create the large uniform surface area on which adsorption takes place, thereby enabling high performance chromatographic separation.

Macropores: 2 μ m

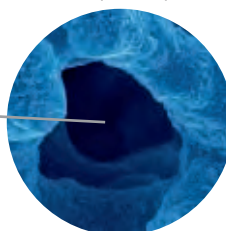

The macropores allow rapid flow of the mobile phase at low pressure. Their average size is 2 μ m.

SEM picture of a cross section from a silica monolith.
Total porosity >80 %

Characterization of Chromolith® HPLC columns

The use of HPLC columns containing the classic 3 or 5 μ m small silica particles often results in high back-pressure. This high back-pressure may damage both the column and the HPLC system; therefore, classic HPLC columns have limited length and a limited number of theoretical plates. Attempts have been made to increase the plate count by decreasing the particle size, but this results in unacceptable back-pressure and limits the variety of separations that can satisfactorily be achieved.

Particularly in industry, chromatographers are trying to find ways of balancing the need to analyze more samples with the limited financial and human resources available. Many of today's scientists wish to speed-up the entire separation process and therefore acceleration of the analysis processes has become one of the most important issues in the high performance liquid chromatography. Laboratory automation of HPLC systems has come a long way toward improving sample throughput by enabling 24 hours a day operation. The systems, however, are still limited by the separation technology itself, that is, the separation columns available. Chromolith® HPLC columns provide excellent separations in a fraction of the time that a standard particulate column will take, because they are made from highly porous monolithic rods of silica with a revolutionary bimodal pore structure. The column is no longer packed with small particles but consists of a single piece of high-purity polymeric silica gel.

Chromolith® columns at glance

Column internal diameter [mm]	Column length [mm]					Loadability	Sensitivity	Solvent saving
	Guard / Trap column 5 mm	Guard / Trap column 10 mm	25 mm	50 mm	100 mm			
25 mm		1.25260.0001 ⁽⁷⁾ 1.25261.0001 ⁽²⁾ 1.25262.0001 Holder			1.25251.0001 ⁽⁷⁾ 1.25252.0001 ⁽²⁾	+	-	-
	10 mm		1.52035.0001 ⁽⁷⁾ Pack of 3 1.52036.0001 ⁽²⁾ Pack of 3 1.52037.0001 Holder		1.52015.0001 ⁽⁷⁾ 1.52016.0001 ⁽²⁾			
		4.6 mm	1.51451.0001 ⁽²⁾ Pack of 3	1.51452.0001 ⁽²⁾ Pack of 3	1.51463.0001 ⁽²⁾			
1.52011.0001 ⁽⁷⁾ Pack of 3			1.52033.0001 Holder	1.52020.0001 ⁽¹⁾	1.52021.0001 ⁽¹⁾	1.51465.0001 ⁽⁷⁾		
1.52013.0001 ⁽⁴⁾ Pack of 3			1.52026.0001 ⁽⁸⁾	1.52027.0001 ⁽⁸⁾	1.51468.0001 ⁽⁴⁾			
1.52025.0001 ⁽¹⁾ Pack of 3			1.52046.0001 ⁽⁵⁾	1.52047.0001 ⁽⁵⁾	1.52022.0001 ⁽¹⁾			
1.52030.0001 ⁽⁸⁾ Pack of 3			1.52056.0001 ⁽³⁾	1.52057.0001 ⁽³⁾	1.52028.0001 ⁽⁸⁾			
1.52032.0001 Holder			1.53170.0001 ⁽⁶⁾	1.53171.0001 ⁽⁶⁾	1.52048.0001 ⁽⁵⁾			
1.52050.0001 ⁽⁵⁾ Pack of 3					1.52058.0001 ⁽³⁾			
1.52059.0001 ⁽³⁾ Pack of 3					1.53172.0001 ⁽⁶⁾			
3 mm	1.52004.0001 ⁽²⁾ Kit		1.52003.0001 ⁽²⁾	1.52002.0001 ⁽²⁾	1.52001.0001 ⁽²⁾			
	1.52005.0001 ⁽²⁾ Pack of 3							
2 mm	1.52008.0001 ⁽²⁾ Kit		1.52014.0001 ⁽²⁾	1.52007.0001 ⁽²⁾	1.52006.0001 ⁽²⁾			
	1.52009.0001 ⁽²⁾ Pack of 3							
Speed +						-		
Resolution -							+	

⁽¹⁾ HighResolution RP-18e | ⁽²⁾ RP-18e | ⁽³⁾ Phenyl | ⁽⁴⁾ RP-8e | ⁽⁵⁾ CN | ⁽⁶⁾ DIOL | ⁽⁷⁾ Si | ⁽⁸⁾ NH₂

Benefits of Chromolith® HPLC columns at a glance

1. Speed of analysis

- Separations two times faster at half the column back-pressure compared to 5 µm columns
- Higher sample throughput – separations up to 9 times faster if required
- Fast column re-equilibration between analyses

2. Improved HPLC system security

- Significantly increased column lifetime
- Reduced maintenance on HPLC pump and injector seals
- Reduced need for sample preparation as columns very resistant to blocking (even with biological samples)

3. Column length no longer pressure limited

- Very high separation efficiency by column coupling

4. Standard HPLC instruments are ideally suited for use with Chromolith® HPLC columns

- Chromolith® columns clad in PEEK are very easy-to-use and handle

5. Cost savings from increased sample throughput can justify the expense of a method revalidation within one month.

Chromolith® HPLC columns

Speed of analysis

Macropores reduce the column back-pressure and allow the use of faster flow rates, thereby considerably reducing the analysis time. **Mesopores** form the fine porous structure and provide the very large active surface area for high efficiency separations.

With Chromolith® columns flow rates can now easily be varied from 1 mL up to 9 mL per minute with the same high quality resolution. A mixture of five beta-blocker drugs demonstrates the extreme time savings and high separation efficiency made possible with Chromolith® columns. Due to excellent mass transfer properties of the monolithic skeleton, high-speed separation is possible even at high flow rate. The beta-blockers were well separated with excellent peak symmetry. At 9 mL/min, the analysis time is less than 1 minute and the column back-pressure is only 153 bar.

Column	Chromolith® Performance RP-18 endcapped, 100–4.6 mm	
Mobile phase	Isocratic acetonitrile / 0.1 % trifluoroacetic acid in water, 20/80 (v/v)	
Pressure	Total pressure (including HPLC system) 25°C	
Detection	UV 220 nm	
Injection volume	5 µL	
Sample	Atenolol	63 µg/mL
	Pindolol	29 µg/mL
	Metoprolol	108 µg/mL
	Celiprolol	104 µg/mL
	Bisoprolol	208 µg/mL

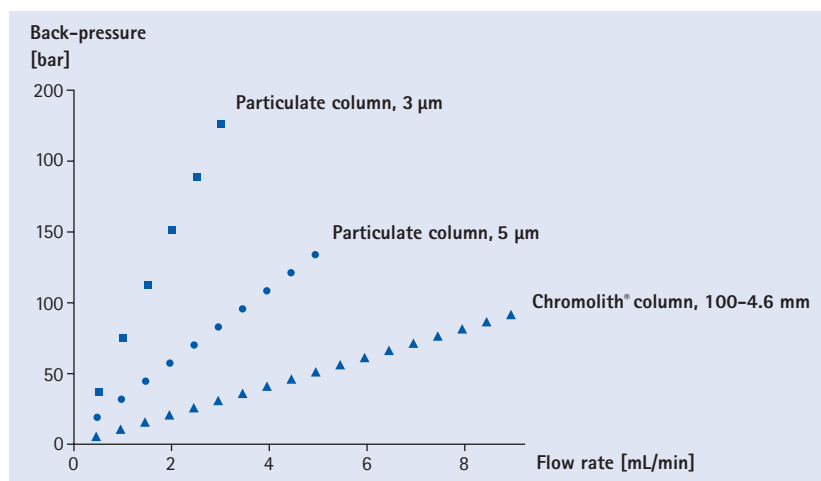

Column back-pressure at different flow rates. Comparison of a Chromolith® Performance column, 100–4.6 mm vs. equivalent classical particulate HPLC columns

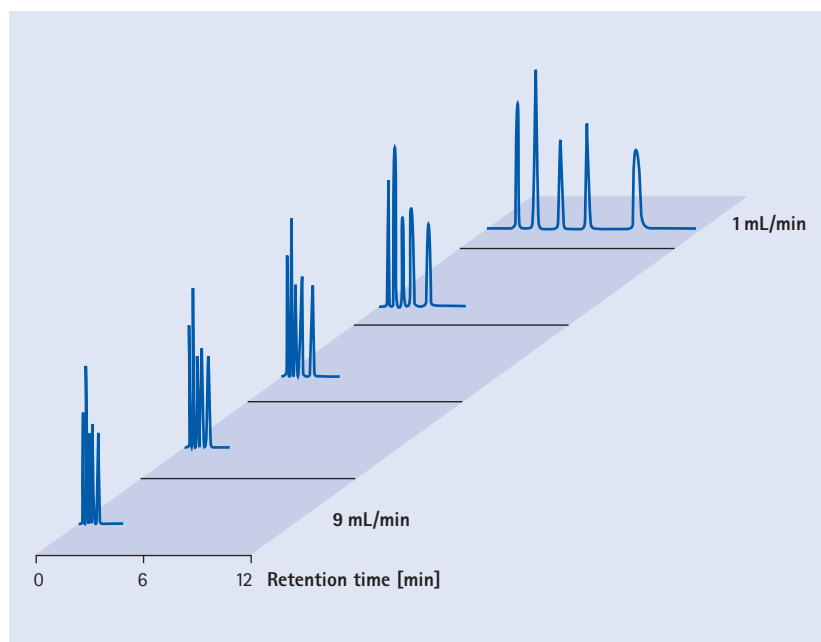

Flow programming

Chromolith® columns are very responsive to changes in flow rate. Flow rates can be changed in mid flow to either enhance the peak definition of the target compound or to shorten the total separation time once the target compound has successfully eluted. This is of particular value to more clearly separate two closely eluting peaks without affecting significantly the total run time. Likewise, it can also reduce total run time when certain compounds elute much later than all the other components of the sample.

Column	Chromolith® Performance RP-18 endcapped, 100-4.6 mm			
Mobile phase	A: Acetonitrile B: 0.1 % Phosphoric acid in water			
Double gradient	Time	% A	% B	Flow rate
	0 min	35	65	3 mL/min
	1.8 min	46	54	3 mL/min
	2.2 min	80	20	5 mL/min
	3 min	80	20	5 mL/min
Pressure	90 bar maximum total pressure			
Detection	UV 254 nm			
Temperature	22°C			
Injection volume	10 µL			
Sample	1. Phenol 2. 2-Chlorophenol 3. 2-Nitrophenol 4. 2,4-Dinitrophenol 5. Chloro-3-methylphenol 6. 2,4-Dinitro-6-methylphenol 7. 2,4,6-Trichlorophenol 8. Pentachlorophenol			

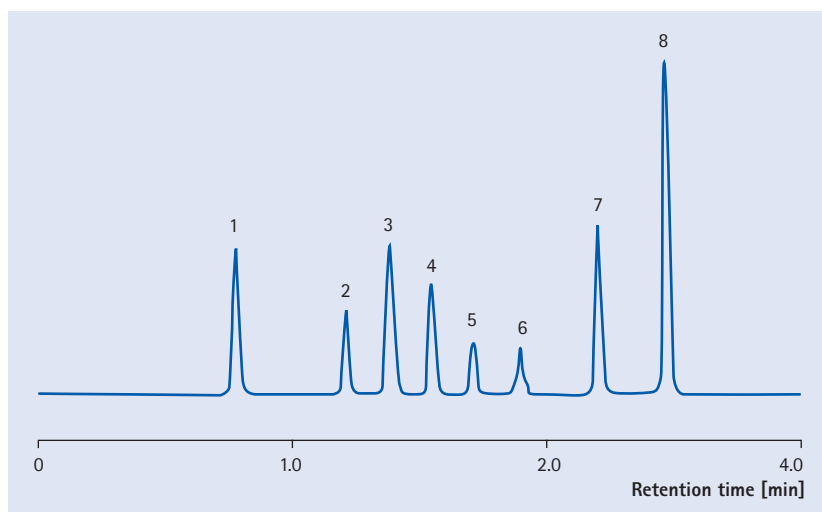

High separation efficiency

The traditional plate-count method of measuring quality shows that the separation efficiency of Chromolith® columns is better than standard 5 µm particulate columns, and just as good as 3.5 µm columns, but with the ability to continue up to 9 mL/min without reaching HPLC system pressure limits. The Van Deemter plot of the Chromolith® column clearly demonstrates that separation efficiency does not decrease significantly when flow rate is increased, as is the case with particulate columns. It is therefore possible to operate Chromolith® columns at high flow rates with minimal loss of peak resolution.

For complex separations, it is still necessary to use long columns in order to provide the separation efficiency required for resolution of all compounds of interest. Chromolith® HPLC columns can be connected in series to produce a column with high plate count at low back-pressure. (Please see: Chromolith® column coupler). With particulate columns, further column length is prevented by excessive back-pressure.

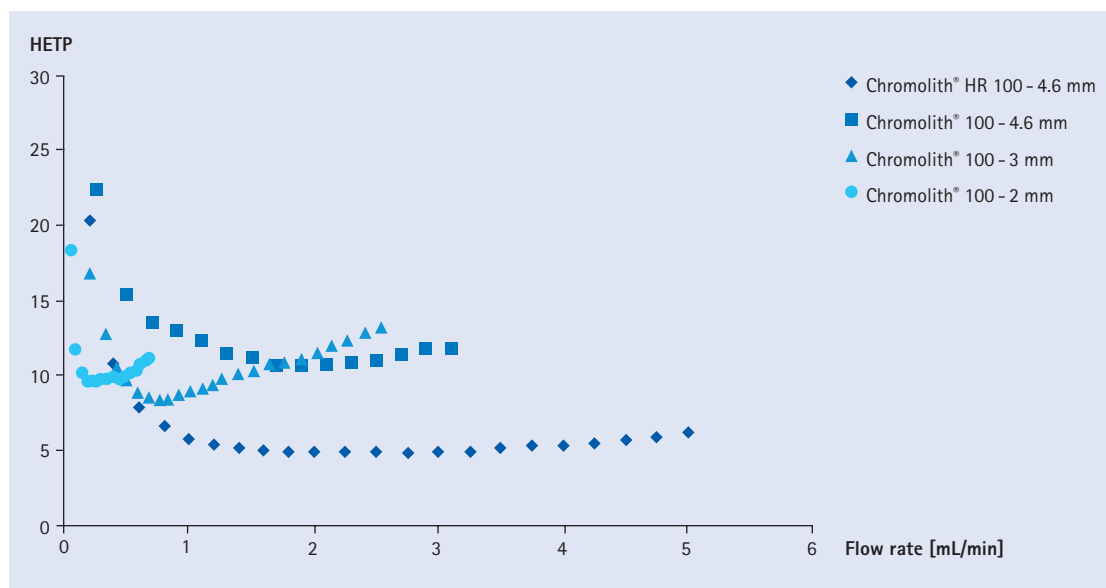

Van Deemter plot of the height equivalent to a theoretical plate (HETP) vs. flow rate for Chromolith® columns.

Long-term stability

Besides lower back-pressure and greater flow rate flexibility, Chromolith® columns also achieve faster equilibration after gradient elution than particle-packed columns of similar dimensions. These features allow high-throughput analysis – without loss of separation efficiency or peak capacity.

Column robustness

Chromolith® columns offer excellent robustness and unsurpassed column lifetime. This not only ensures maximum reliability and versatility, but also minimizes maintenance on the HPLC system. As a result, Chromolith® columns reduce costs per analysis while enhancing data integrity.

Food colorants in an alcoholic beverage with Chromolith® Performance RP-18e

Column	Chromolith® Performance RP-18 endcapped 50 x 2.0 mm	Mobile phase (v/v)	A: Acetonitrile B: 0.1 % Phosphoric acid in water		
Pressure drop	45 – 40 bar (648 – 556 psi)	Gradient program	Time	% A	% B
Detection	UV 500 nm		0.00 – 0.50 min	0	100
Cell	1.4 µL		0.50 – 4.50 min	0 → 50	100 → 50
Flow rate	0.4 mL/min		4.50 – 5.00 min	50 → 95	50 → 5
Temperature	25°C		5.00 – 6.00 min	95	5
Injection volume	2 µL		6.00 – 7.00 min	95 → 95	5 → 100
Sample	Prior to analysis, the sample was filtered using a syringe equipped with a 0.45 µm filter disc.				

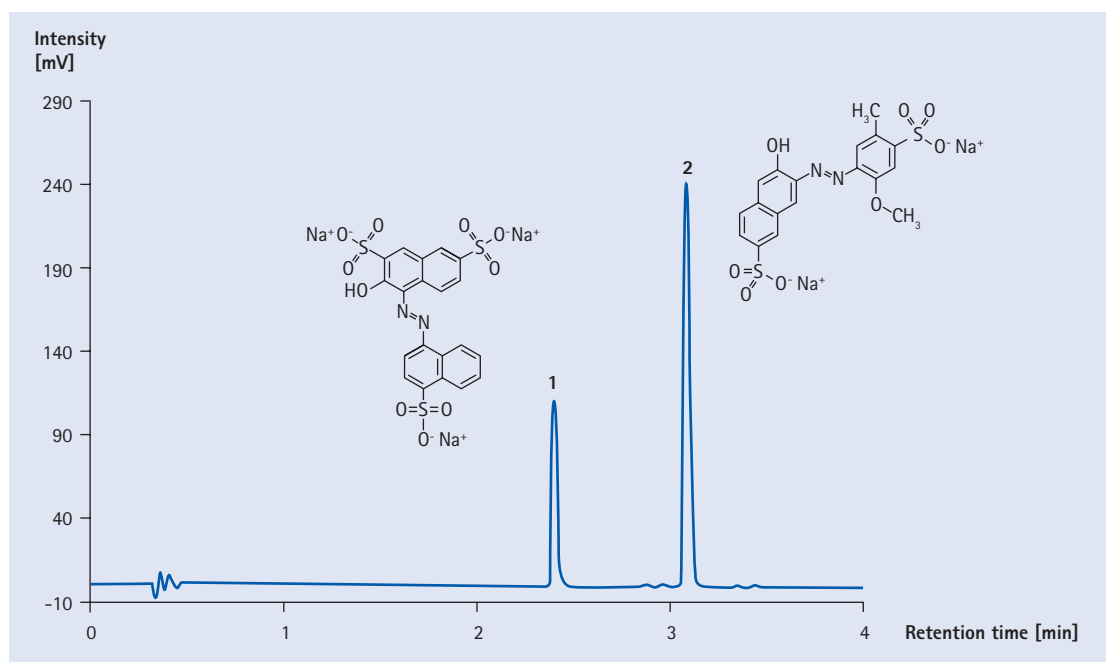

Analysis of colorants in rum. Two food colorants in rum, E 123 (Amaranth) and E 129 (Allura Red AC), were analyzed to illustrate the long-term performance and method robustness of Chromolith® columns. More than 8000 samples (total volume of injected sample: 16 mL + 30 L mobile phase) were analyzed on a 50 x 2.0 mm Chromolith® RP-18e column.

Evaluation of the robustness of a Chromolith® column for the analysis of food colorants in rum

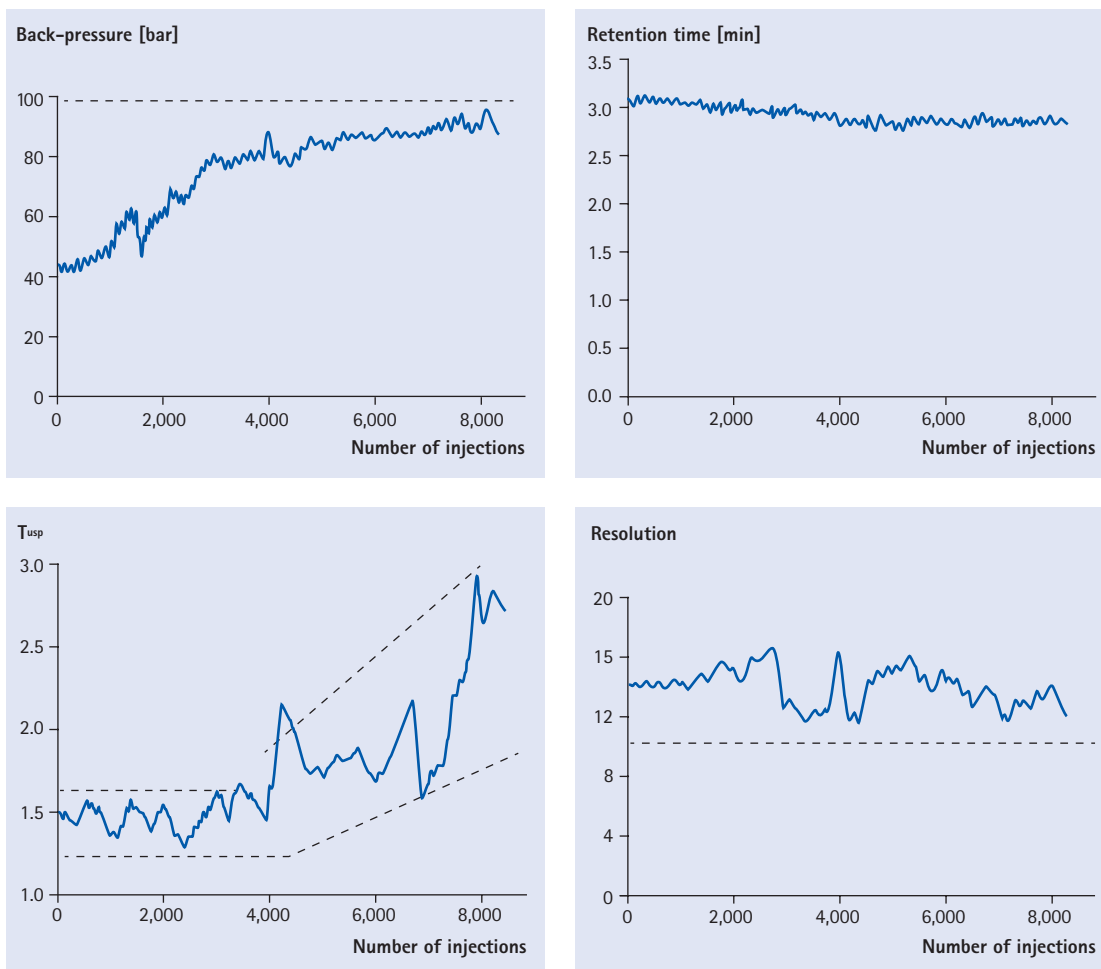

The figures above illustrate how column back-pressure, peak shape, and the chromatographic resolution between E129 (Allura Red AC) and E123 (Amaranth) are affected with time; 8300 samples were analyzed. The largest effects are seen on peak shape and back-pressure. A similar T_{usp} value is obtained over the first 4000 injections, after which some deterioration is observed. Despite aging of the column, peak integration and thereby accurate quantitation of the two analytes is achieved. The column back-pressure increases with time as sample matrix is accumulated in the column but never reaches over 100 bar (1450 psi). The chromatographic resolution between the analytes is substantial ($R_s > 10$) with good overall retentivity and no additional disturbing peaks are found in the chromatogram (UV detection at 500 nm).

Cost savings

Using Chromolith® the time of analysis is much shorter than when using a particulate column. The cost per analysis can usually be halved at least, thereby paying back method revalidation expenses in about 3 weeks.

1 hour HPLC lab time in USA typically	costs	\$ 100	per hour
Revalidating one HPLC method requires 3 weeks lab time and	costs	\$ 12,000	per revalidation
New faster Chromolith® HPLC method cuts analysis time by 50 % saving 4 hours per day	saves	\$ 400	per day
Run the new faster Chromolith® method for 30 days	total savings	\$ 12,000	after 30 days, revalidation has paid for itself
After running the new faster Chromolith® method for one year	total savings	\$ 80,000	assuming only 200 days

Optimal flow rate ranges for Chromolith® columns

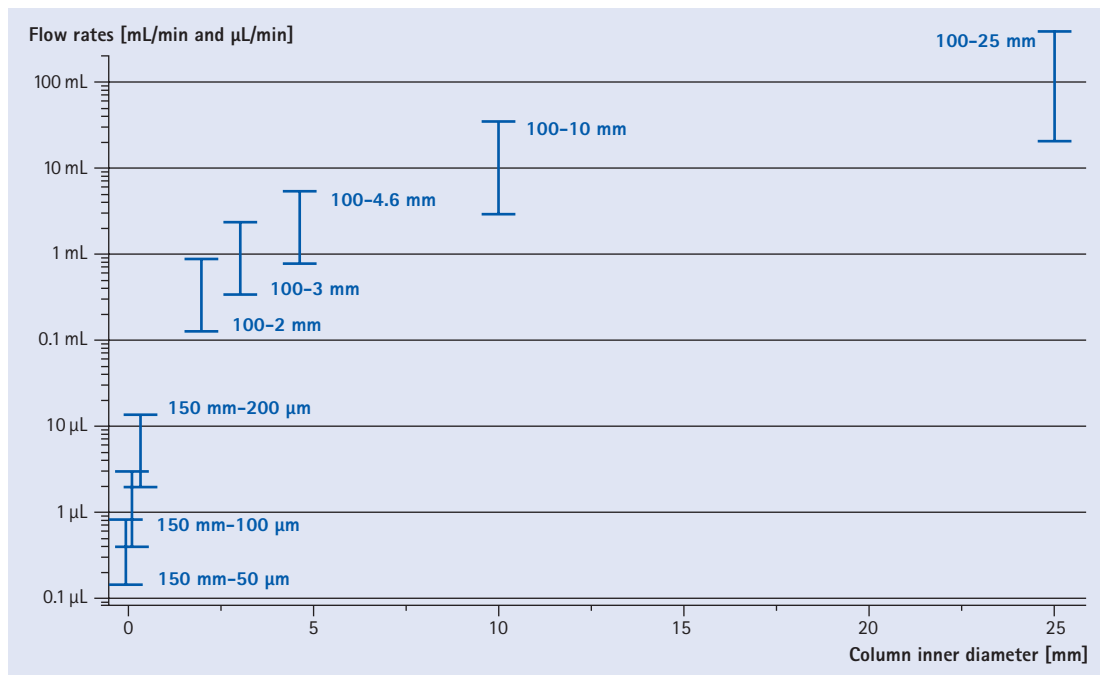

Chromolith® column length 100 mm for 2 mm, 3 mm, 4.6 mm, 10 mm and 25 mm column inner diameter

Chromolith® CapRod® column length 150 mm for 50 µm, 100 µm and 200 µm monolithic capillaries

Chromolith® RP-18 endcapped

Chromolith® RP-18 endcapped columns
are the fastest C18 columns in the world.

Chromolith® RP-18 endcapped

As the chemical basis of the Chromolith® RP-18 endcapped columns from the starting materials up to the surface modification procedures is the same as with the high-end conventional packed columns they possess a selectivity comparable to high-quality C18 endcapped packed reversed-phase columns. Therefore the chromatographer can use the standard methods when developing a new protocol. Chromolith® columns for reversed phase chromatography are based on a high-purity silica, the gold standard in HPLC, to reduce the negative effect of trace metals. They are chemically modified with n-alkyl chains with a high ligand density and then fully endcapped in order to reduce the effect of unmodified silanol groups.

Benefits of Chromolith® RP-18 endcapped

- high throughput at high flow rates with the best overall column quality
- the possibility of flow gradients
- added column performance by column coupling
- a rigid monolithic structure for a longer lifetime
- less matrix-sensitivity

Specifications of Chromolith® RP-18 endcapped

Silica type	High-purity
Particle size	Monolithic
Macropore size	1.5 µm (2 mm i.d. columns) 2 µm (25, 10, 4.6 and 3 mm i.d. columns)
Mesopore size	13 nm (130 Å)
Pore volume	1 mL/g
Total porosity	>80 %
Surface area	300 m ² /g
Surface modification	RP-18 endcapped
Carbon content	18 %

Chromolith® HighResolution columns – the faster way for trouble-free high resolution separations

New Chromolith® HighResolution columns offering higher efficiency and improved peak shape at the expense of higher back-pressure which is anyway more than 2 times lower than any same dimension particulate packed column. At 1 mL/min flow rate a chromatogram run on a Chromolith® HighResolution column looks almost identical to the same chromatogram run on the particulate column packed with sub 3 µm particles. Chromolith® HighResolution is even able to generate similar results as column packed with 2.6 µm i.d. core-shell particles, however at much lower back-pressures.

Benefits of Chromolith® HighResolution columns

- Column performance corresponds to sub 3 µm particle packed columns and it is at least 50 % higher compared to our standard Chromolith® columns
- Back-pressure still more than 2 times lower compared to particulate packed columns
- 30 % longer column lifetime compared to particle packed columns

Specifications of Chromolith® HighResolution RP-18 endcapped

Silica type	High-purity
Particle size	Monolithic
Macropore size	1.15 µm
Mesopore size	15 nm (150 Å)
Pore volume	1 mL/g
Total pore volume	2.9 mL/g
Surface area	250 m ² /g
Surface modification	RP-18 endcapped
Carbon content	18 %

▶ Chromolith® CapRod®
Monolithic capillary
page 201

▶ Chromolith® RP-8
endcapped
page 230

▶ Chromolith® Si
page 238

▶ Chromolith®
guard cartridges and
cartridge kit
page 243

▶ Chromolith® column
coupler
page 248

▶ Chromolith® SemiPrep
Perfect scale-up from
analytical to preparative
LC
page 250

▶ Chromolith® Prep
Chromolith® – increase
in speed, efficiency and
productivity
page 254

Differentiation between Chromolith® and Chromolith® HighResolution

New Chromolith® HighResolution has around 50 % higher efficiency, excellent peak symmetry and still more than 30 % longer lifetime compared with particulate columns. Two Chromolith® HighResolution columns could be easily coupled in order to achieve even higher resolution. The completely endcapped stationary phase enables the peak-tailing free elution of basic compounds. Samples rich of matrix should be analyzed with Chromolith® as this type of column will have longer lifetime. Also lower back-pressure would allow one to couple more columns once it is needed.

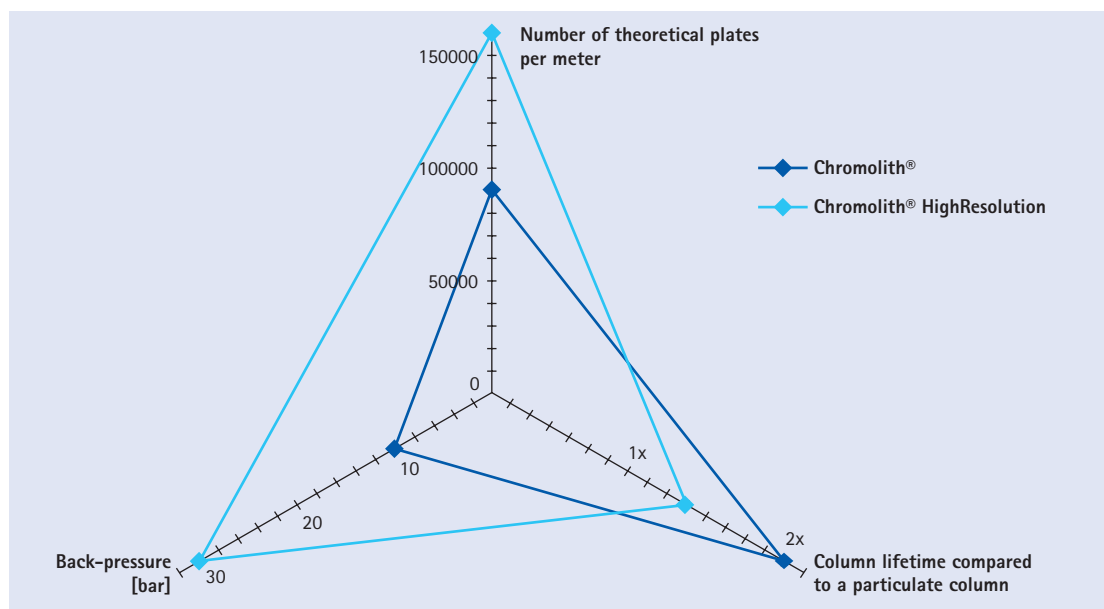

Analytical HPLC

Higher efficiency, symmetrical peaks

Chromolith® Performance RP-18e, 100-4.6 mm

Chromolith® HighResolution RP-18e, 100-4.6 mm

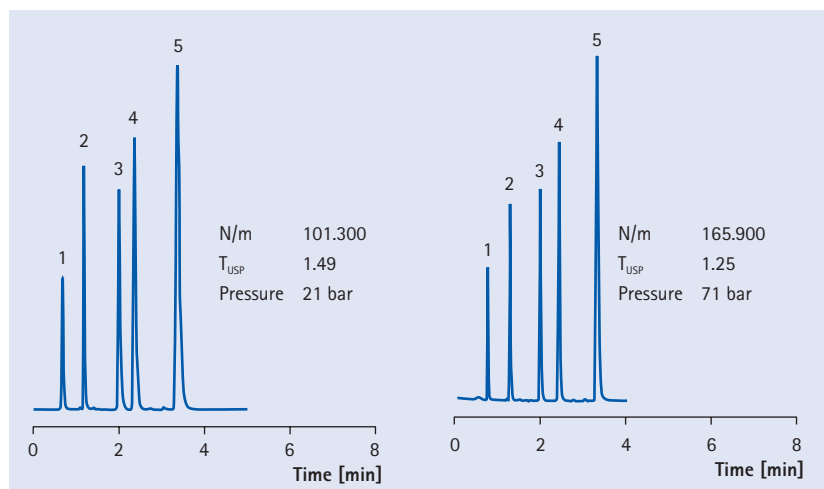

Mobile phase	Acetonitrile/water 60/40
Flow rate	2 mL/min
Detection	UV 254 nm
Temp.	ambient
Injection volume	5 µL
Sample	1. Urea 2. Biphenyl-2-ol 3. Progesterone 4. Hexanophenone 5. Anthracene

Improved peak shape for basic compounds

Completely endcapped stationary phase enables the elution of basic compounds with no tailing.

Chromolith® HighResolution RP-18e, 100–4.6 mm

Mobile phase	A: ACN B: 20 mM NaH ₂ PO ₄ buffer pH 7.6
Gradient	0 min 20 % A 0.5 min 45 % A
Flow rate	2 mL/min
Column pressure	63–69 bar
Detection	UV 254 nm
Vol. detector cell	16 µL
Temperature	ambient
Injection volume	1 µL
Sample	1. Caffeine 2. Aniline 3. N-Methylaniline 4. 2-Ethylaniline 5. 4-Nitranisole 6. N,N-Dimethylaniline

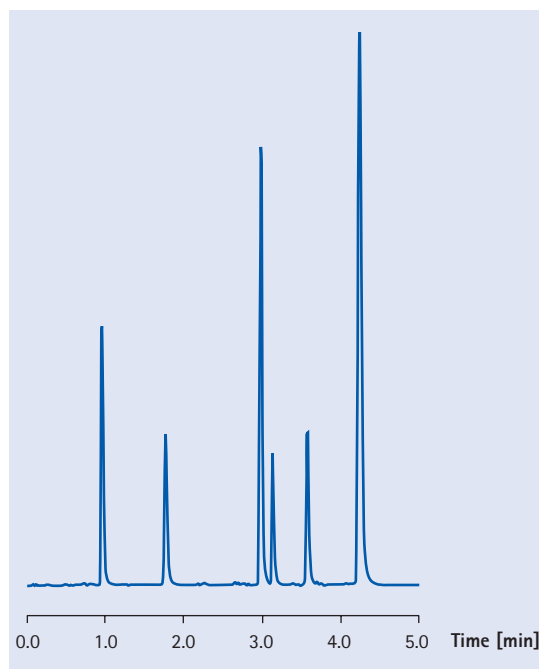

Excellent batch-to-batch reproducibility

The batch-to-batch reproducibility of Chromolith® HPLC columns is tightly controlled and fulfills the requirements for QA/QC laboratories.

Chromolith® HighResolution RP-18e, 100–4.6 mm

Mobile phase	A: Acetonitrile + 0.1 % TFA B: Water + 0.1 % TFA
Gradient	2 min 0 % A 10 min 30 % A
Flow rate	1 mL/min
Detection	UV 210 nm
Temp.	25°C
Injection volume	2 µL
Sample	1. Norepinephrine 2. Octopamine 3. Epinephrine tartrate 4. Dopamine 5. DOPA 6. Norephedrine 7. Ephedrine 8. N-Methylephedrine

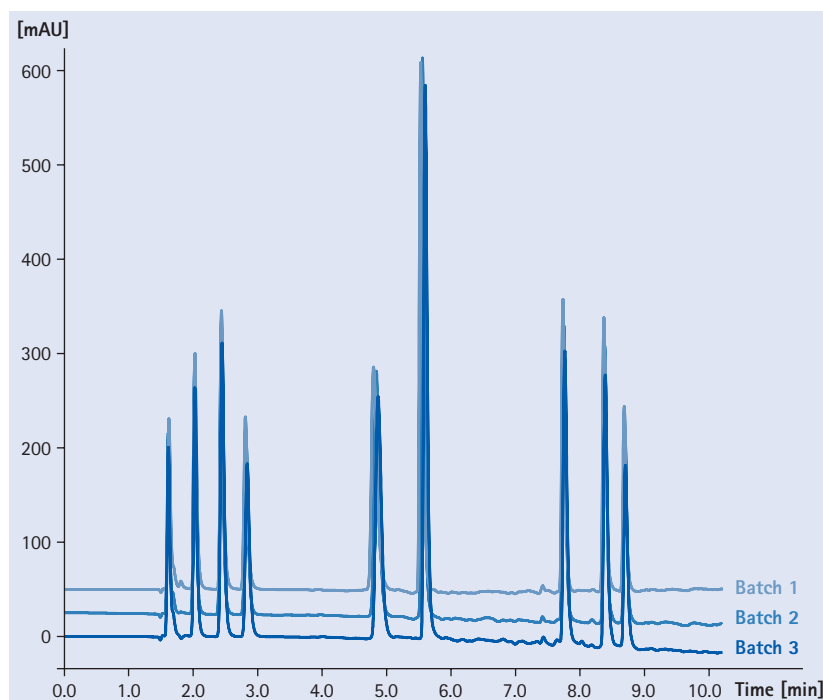

Ordering information – Chromolith® RP-18 endcapped

Product	Ordering No.	Dimension length	Dimension diameter	Contents of one package
Chromolith® Performance RP-18 endcapped	1.02129.0001	100 mm	4.6 mm	1 piece
Chromolith® Performance RP-18 endcapped validation kit (3 columns from 3 different batches)	1.51466.0001	100 mm	4.6 mm	3 pieces
Chromolith® SpeedRod RP-18 endcapped	1.51450.0001	50 mm	4.6 mm	1 piece
Chromolith® Flash RP-18 endcapped	1.51463.0001	25 mm	4.6 mm	1 piece
Chromolith® Performance RP-18 endcapped	1.52001.0001	100 mm	3 mm	1 piece
Chromolith® Performance RP-18 endcapped validation kit (3 columns from 3 different batches)	1.52063.0001	100 mm	3 mm	3 pieces
Chromolith® FastGradient RP-18 endcapped	1.52002.0001	50 mm	3 mm	1 piece
Chromolith® Flash RP-18 endcapped	1.52003.0001	25 mm	3 mm	1 piece
Chromolith® Performance RP-18 endcapped	1.52006.0001	100 mm	2 mm	1 piece
Chromolith® FastGradient RP-18 endcapped	1.52007.0001	50 mm	2 mm	1 piece
Chromolith® FastGradient RP-18 endcapped validation kit (3 columns from 3 different batches)	1.52062.0001	50 mm	2 mm	3 pieces
Chromolith® Flash RP-18 endcapped	1.52014.0001	25 mm	2 mm	1 piece

Ordering information – Chromolith® HighResolution RP-18 endcapped

Product	Ordering No.	Dimension length	Dimension diameter	Contents of one package
Chromolith® HighResolution RP-18 endcapped	1.52022.0001	100 mm	4.6 mm	1 piece
Chromolith® HighResolution RP-18 endcapped	1.52023.0001	150 mm	4.6 mm	1 piece
Chromolith® HighResolution RP-18 endcapped validation kit (3 columns from 3 different batches)	1.52019.0001	100 mm	4.6 mm	3 pieces
Chromolith® HighResolution RP-18 endcapped	1.52021.0001	50 mm	4.6 mm	1 piece
Chromolith® HighResolution RP-18 endcapped	1.52020.0001	25 mm	4.6 mm	1 piece

Chromolith® RP-18 endcapped

Chromolith® RP-18 endcapped products

Three different column lengths of **Chromolith® RP-18 endcapped** are available: such as the **Chromolith® Flash RP-18e**, the **Chromolith® SpeedROD/FastGradient RP-18e** and the **Chromolith® Performance RP-18e** columns, which are opening the door to high-speed separations!



Chromolith® 25 mm length – for ultra-fast separation of simple mixtures

Chromolith® Flash RP-18 endcapped columns are very short and perfect for ultra-fast analysis simple mixtures. The length of the column is 25 mm and therefore the number of theoretical plates of the **Chromolith® Flash RP-18 endcapped column** is sufficient for easy separations. The major focus of the **Chromolith® Flash RP-18 endcapped columns** is clearly on the speed of analysis, since it provides the chromatographer with the fastest HPLC column, which is available on the market!



Chromolith® 50 mm length – for fast separation of simple mixtures

Chromolith® SpeedROD RP-18 endcapped columns are short and perfect for fast analysis. **Chromolith® SpeedROD RP-18 endcapped HPLC columns** are ideal for use in rapid screening of samples especially for the in-process control as well as in research laboratories or those specializing in organic synthesis, e.g. combinatorial chemistry.



Chromolith® 100 mm and 150 mm length – for rapid separation of more complex mixtures

Chromolith® Performance RP-18 endcapped columns provide rapid high quality separation of complex multi-component mixtures. They are therefore perfect for use as a routine analytical tool in the quality control laboratory or in research laboratories where more complex mixtures are being analyzed.

Chromolith® validation kits

For correct method validation, it is essential to assess all possible sources of variations. To assist the validation process, the **Chromolith® validation kit** includes three columns from three different production batches, in order to compare the batch-to-batch reproducibility and quality. The **Chromolith® validation kits** are therefore perfect for use as an appropriate tool in quality control laboratories or in validation laboratories. The cost and time savings through use of Chromolith® columns can repay the expense of a method revalidation within one month.

Separation examples on Chromolith® RP-18 endcapped
Detection of Polyphenols in coffee

Column	Chromolith® Performance RP-18 endcapped, 2 x 100-4.6 mm	
Mobile phase (v/v)	A: 100 % Acetonitril B: 100 % Water + 0.1 % TFA v/v	
Gradient	0-3 min	10 % A
	3-14 min	10 % to 50 % A
Flow rate	2 mL/min	
Pressure drop	83-93 bar (9.3 MPa, 1337 psi)	
Detection	2.5 Hz, Response time 0.1 s, UV = 327 nm	
Cell	11 µL	
Temperature	ambient	
Injection volume	1 µL	
Sample preparation	6 g of coffee powder with 200 mL of boiling water in a coffee-extractor. The extract was injected directly into the HPLC-System.	
Sample	<ol style="list-style-type: none"> 1. void volume (t₀) 2. Chlorogenic acid 3. Esculetin 4. Caffeic acid 5. Scopoletin 6. Rutin 7. Troxerutin 8. Quercetin 9. Trihydroxyethyl-luteolin 10. Kaempferol 	

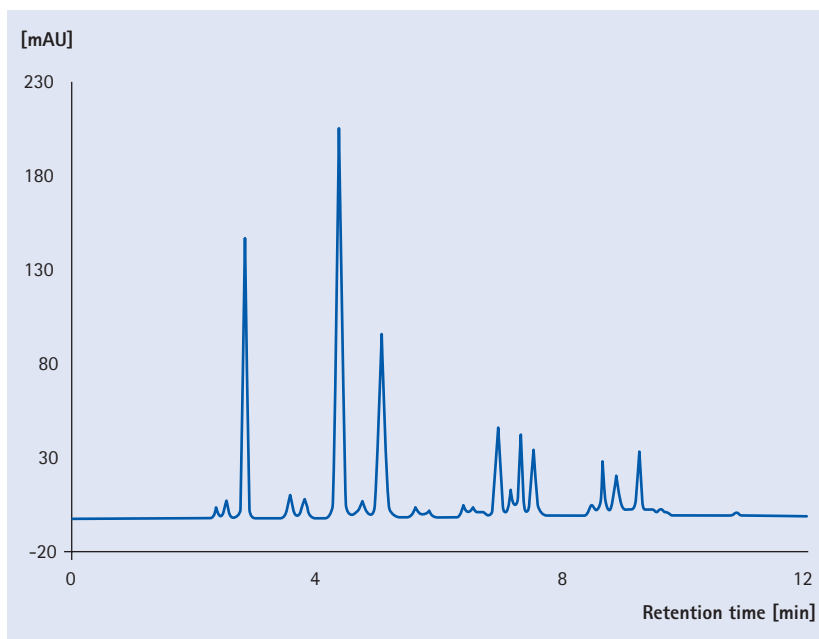

Chromolith® SpeedROD RP-18 endcapped

Column	Chromolith® SpeedROD RP-18 endcapped, 50-4.6 mm		
Mobile phase	A: Acetonitrile B: 0.01M Phosphate buffer pH 5.0		
Gradient	Time [min]	% A	% B
	0.0	3	97
	2.5	3	97
	2.6	8	92
	5.0	8	92
Flow rate	4 mL/min		
Detection	227 nm		
Temperature	ambient		
Injection volume	10 µL		
Sample	<ol style="list-style-type: none"> 1. Acesulfame-K 2. Saccharin 3. Benzoic acid 4. Sorbic acid 5. Caffeine 6. Aspartame 	<ol style="list-style-type: none"> 23 µg/mL 29 µg/mL 13 µg/mL 14 µg/mL 47 µg/mL 100 µg/mL 	

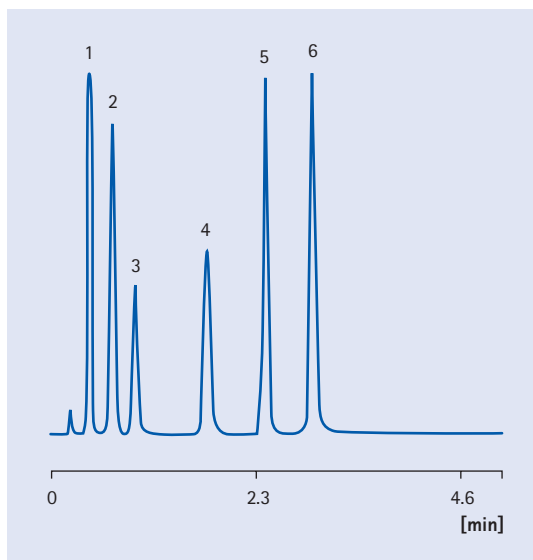

Chromolith® Performance RP-18 endcapped Separation of Carbidopa

Column	Chromolith® Performance RP-18 endcapped, 100-4.6 mm	
Mobile phase	A: Methanol B: 0.1 % TFA in water	
Gradient	0.0 min 100 % B 1.0 min 100 % B 10 min 80 % B	
Flow rate	2 mL/min	
Detection	UV 282 nm	
Temperature	ambient	
Injection volume	5 µL	
Sample	1. 2,4,5-Trihydroxyphenylalanine	125 µg/mL
	2. Levodopa	235 µg/mL
	3. Methyl dopa	160 µg/mL
	4. Dopamine	190 µg/mL
	5. Carbidopa	175 µg/mL
	6. 3,4-Dihydroxyphenylacetic acid	185 µg/mL
	7. 3-o-Methylcarbidopa	105 µg/mL

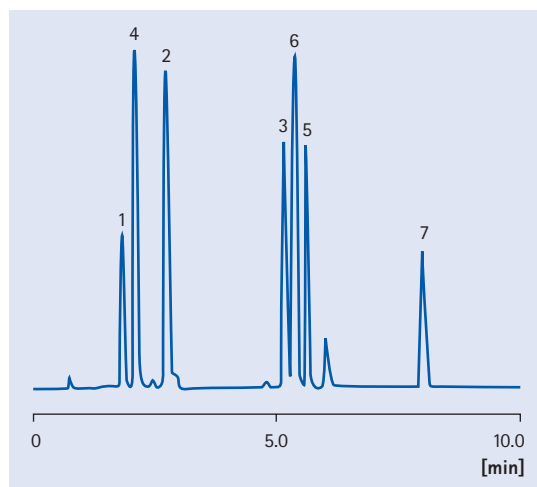

Developed by ChromSword Auto software

Separation of Steroids

Column	2 columns of Chromolith® Performance RP-18 endcapped	
Mobile phase	A: Acetonitrile B: Water	
Gradient	0 min 80 % B 7.0 min 10 % B	
Flow rate	3.0 mL/min	
Detection	UV 220 nm	
Temperature	ambient	
Injection volume	10 µL	
Sample	1. Prednisolone	
	2. Cortisone	
	3. Nortestosterone	
	4. Estradiol	
	5. Testosterone	
	6. Corticosterone	
	7. Estrone	
	8. Progesterone	

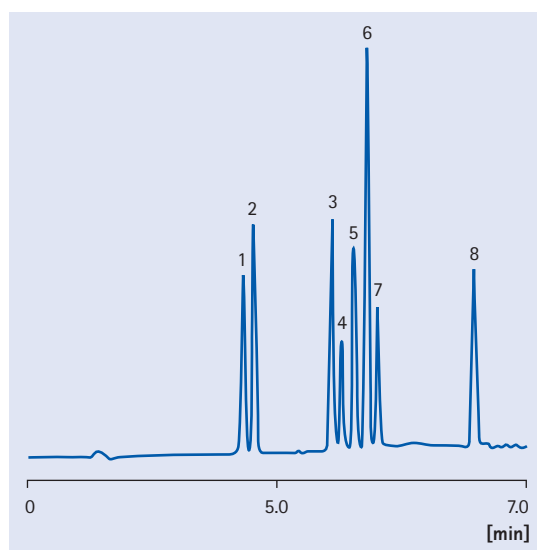

Chromolith® HighResolution is the ideal alternative to a sub 3 µm particulate column

At 1 mL/min flow rate a chromatogram run on a Chromolith® HighResolution column looks almost identical to the same chromatogram run on the corresponding particulate column. A Chromolith® HighResolution is able to generate similar results to a column packed with core-shell particles, however at much lower back-pressure.

Column	Chromolith® HighResolution RP-18, 50-4.6 mm, Silica monolith		
Mobile phase	A: Acetonitrile B: 20 mM Phosphate buffer pH 4.5		
Gradient	Time [min]	% A	% B
	0.0	20	80
	12.0	40	60
Flow rate	1.0 mL/min		
Pressure	40 bar		
Detection	UV 230 nm		
Temperature	22°C		
Injection volume	2 µL		
Sample	1. Ascorbic acid 2. 4-Hydroxybenzoic acid 3. Benzoic acid 4. Sorbic acid 5. Methyl 4-hydroxybenzoate 6. Ethyl 4-hydroxybenzoate 7. Propyl 4-hydroxybenzoate		

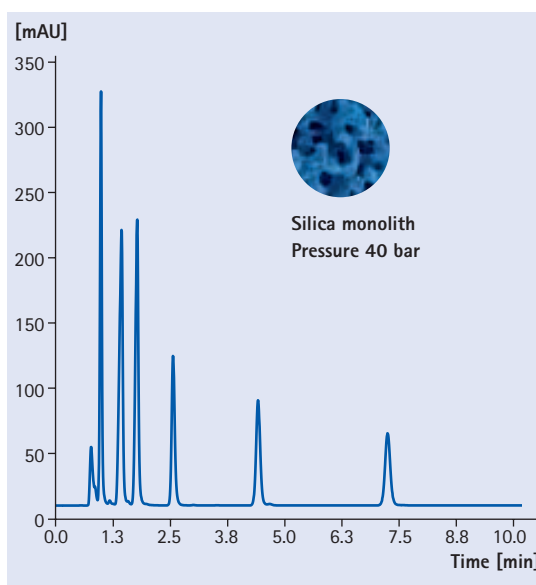

Column	Core-shell RP-18e, 50-4.6 mm, 2.6 µm particles		
Mobile phase	A: Acetonitrile B: 20 mM Phosphate buffer pH 4.5		
Gradient	Time [min]	% A	% B
	0.0	20	80
	12.0	40	60
Flow rate	1.0 mL/min		
Pressure	100 bar		
Detection	UV 230 nm		
Temperature	22°C		
Injection volume	2 µL		
Sample	1. Ascorbic acid 2. 4-Hydroxybenzoic acid 3. Benzoic acid 4. Sorbic acid 5. Methyl 4-hydroxybenzoate 6. Ethyl 4-hydroxybenzoate 7. Propyl 4-hydroxybenzoate		

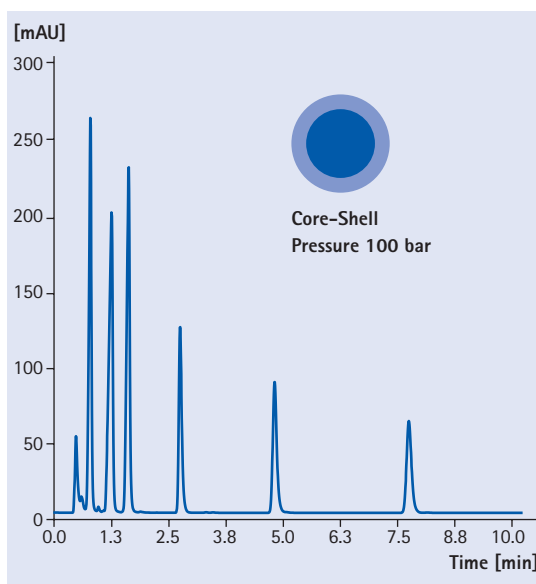

Speed is there when you need it

Short monolithic columns will deliver ultra-fast results at low back-pressure for isocratic and gradient applications: high sample throughput and fast column re-equilibration between analyses.

Chromolith® HighResolution RP-18e, 50–4.6 mm

Column	Chromolith® HighResolution RP-18e, 50–4.6 mm
Mobile phase	A: ACN B: 0.02 M Phosphate buffer pH 2.5
Gradient	0.0 min 20 % A 0.3 min 40 % A
Flow rate	3.5 mL/min
Column pressure	49–71 bar
LC system	LaChrom® L7000
Detection	UV 230 nm
Vol. detector cell	16 µL
Temperature	ambient
Injection volume	1 µL
Sample	1. Atenolol 2. Pindolol 3. Metoprolol 4. Bisoprolol 5. Labetalol 6. Propranolol

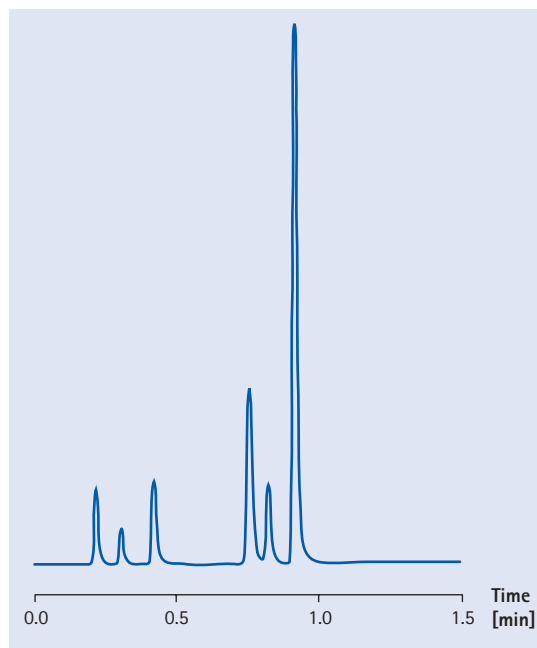

Chromolith® HighResolution RP-18e, 150–4.6 mm Separation of vitamins D2 and D3

Column	Chromolith® HighResolution RP-18e, 150–4.6 mm
Mobile phase	90 % ACN / 10 % water
Flow rate	4 mL/min
Pressure	147 bar
Detection	280 nm
Temperature	25°C
Injection volume	5 µL
Sample	1. Vitamin D2 2. Vitamin D3

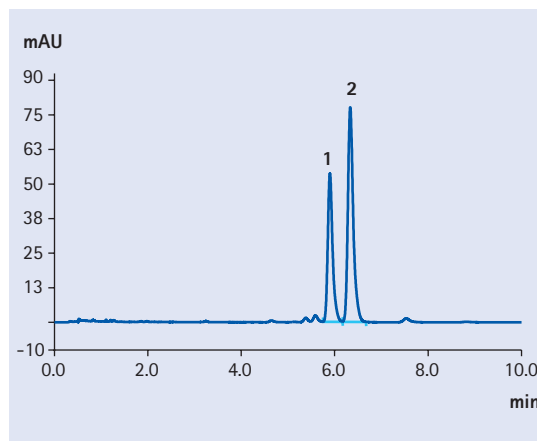

Increase the sensitivity and save solvents with 3 mm and 2 mm i.d. Chromolith® RP-18 endcapped products

Chromolith® RP-18 3 mm i.d. columns – fast separations at lower flow rates

The first figure shows a typical fast separation of four compounds in less than two minutes using a Chromolith® 4.6 mm internal diameter column at 4 mL/min. The second figure shows the same separation on Chromolith® 3 mm i.d. column with improved sensitivity and at just 1.7 mL/min, saving 57 % solvents. Both chromatograms show excellent column efficiency and peak resolution.

Chromolith® Performance RP-18e 100–4.6 mm

Column	Chromolith® RP-18 endcapped 100–4.6 mm
Mobile phase	Acetonitrile / water 40/60
Flow rate	4.0 mL/min
Pressure	137 bar
Detection	UV 254 nm 2.4 µL flow cell
Temperature	ambient
Injection volume	1 µL
Sample	1. Biphenyl-4.4' -ol 2. Biphenyl-2.2' -ol 3. Biphenyl-4-ol 4. Biphenyl-2-ol

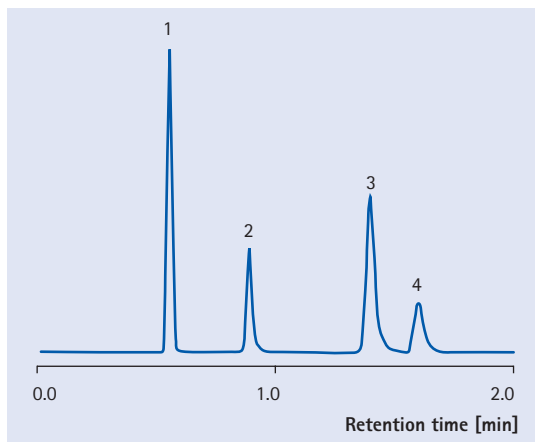

Chromolith® Performance RP-18e 100–3 mm

Column	Chromolith® RP-18 endcapped 100–3 mm
Mobile phase	Acetonitrile / water 40/60
Flow rate	1.7 mL/min
Pressure	100 bar
Detection	UV 254 nm 2.4 µL flow cell *
Temperature	ambient
Injection volume	1 µL *
Sample	1. Biphenyl-4.4' -ol 2. Biphenyl-2.2' -ol 3. Biphenyl-4-ol 4. Biphenyl-2-ol

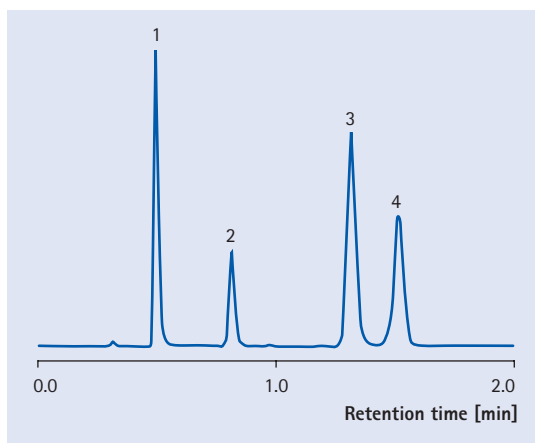

* For optimum results with 3 mm columns, extra-column volume must be small.

Chromolith® Performance
RP-18 endcapped 100–3 mm

Chromolith® RP-18 endcapped

Chromolith® Performance RP-18 endcapped 100 – 3 mm is an ideal alternative to conventional particulate columns with internal diameter 4.6, 4 or 3 mm. Even difficult separations, which often take 15 – 30 minutes on particulate columns, typically take only 5 – 10 minutes on Chromolith® 3 mm. Chromolith® 3 mm columns are easily coupled using the column coupler [Ord. No. 1.51467.0001] to give columns 20 cm or longer as required. The result is shown below: very high peak resolution at moderate pressure with flow rates between 1-1.5 mL/min.

Chromolith® Performance RP-18e 100-3 mm

Column	Chromolith® Performance RP-18e 100-3 mm
Mobile phase	Acetonitrile / buffer pH 1.8 (gradient)
Flow rate	2.0 mL/min
Pressure	92 bar
Detection	UV 254 nm
Temperature	30°C
Injection volume	1 µL
Sample	1. – 2. by-products 3. Levothyroxine 4. – 9. by-products

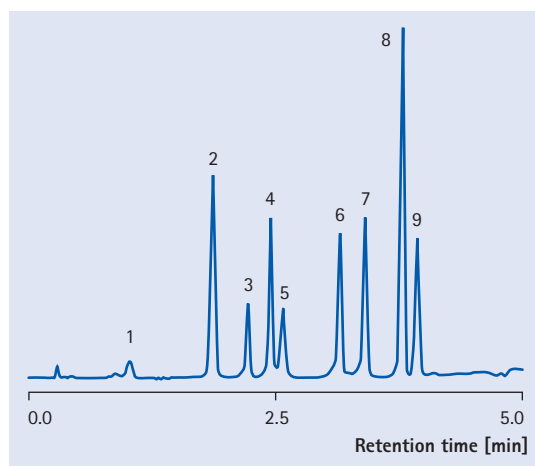

2 coupled Chromolith® Performance RP-18e 100-3 mm

Column	2 coupled Chromolith® Performance RP-18e 100-3 mm
Mobile phase	Acetonitrile / buffer pH 1.8 (gradient)
Flow rate	1.5 mL/min
Pressure	140 bar
Detection	UV 254 nm
Temperature	30°C
Injection volume	1 µL
Sample	1. – 2. by-products 3. Levothyroxine 4. – 9. by-products

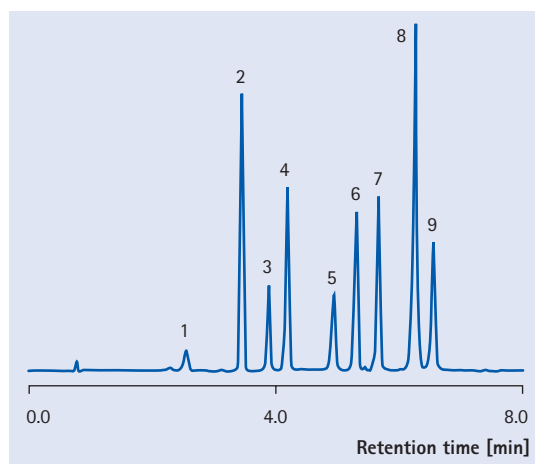

Two columns coupled together

Chromolith® RP-18 endcapped 2 mm i.d. columns – ultra high performance on any instrument

Ultra-high performance in combination with extraordinary low operating pressure makes the Chromolith® 2 mm column technology unique. Excellent "ultra-fast" results are obtained, not only in the new UHPLC and UPLC® instruments, but equally well in all standard HPLC systems with low dead volume. Chromolith® 2 mm columns have macropores with 1.5 µm diameter, giving a column efficiency exceeding 100,000 plates/meter. The mesopores are 13 nm (130 Å) and the surface modification is octadecylsilane with full endcapping.

Benefits at a glance

- **Flexibility** – this column gives very fast, high performance results with all low dead volume LC instruments, whether UHPLC, UPLC® or standard HPLC
- **Increase the sensitivity and save solvents** – compared to 4.6 mm i.d. column 81 % of solvents is saved and 5.7 times higher sensitivity simultaneously achieved
- **Flow rates from 0.2 – 1 mL/min** give ideal compatibility with LC / MS systems, both with ESI and APCI interfaces
- **Long column lifetime and resistance to column blocking** – thanks to monolithic silica structure and absence of frits – gives method robustness and cost saving



Separation of alkylphenones

Column	Chromolith® Performance RP-18 endcapped 100-2 mm		
Mobile phase	A: Acetonitrile B: Water		
Gradient	Time [min]	% ACN	% Water
	0	15	85
	3.5	90	10
	5	90	10
	5.1	15	85
	6	15	85
Flow rate	0.38 mL/min		
Pressure	37-79 bar		
Detection	254 nm		
Temperature	ambient		
Injection volume	0.5 µL		
Sample	<ol style="list-style-type: none"> 1. Thiurea 2. Acetanilide 3. Acetophenone 4. Propiophenone 5. Benzophenone 6. Butyraphenone 7. Valerophenone 8. Hexanophenone 9. Heptanophenone in ACN/Water 60/40 		

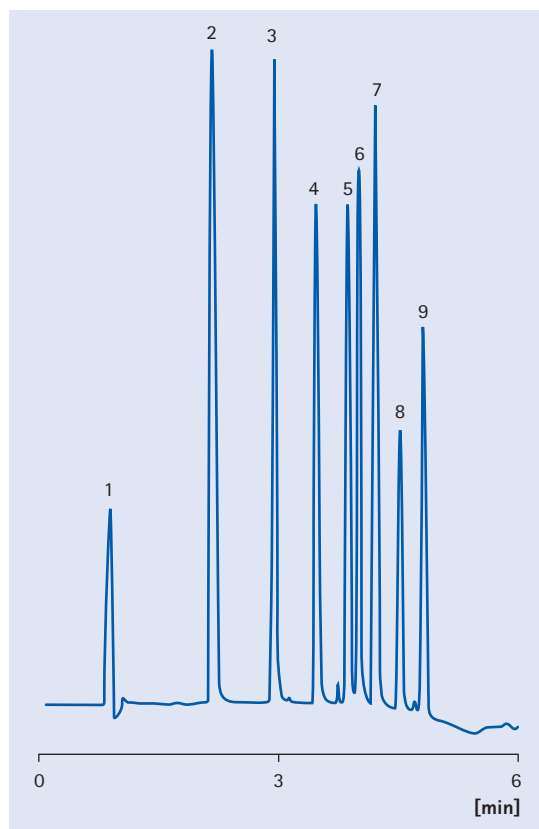

Ultra-fast separation of Antihistamines

Column	Chromolith® FastGradient RP-18e 50-2 mm
Mobile phase	A: 0.1 % TFA in water B: 0.1 % TFA in ACN
Gradient	5 % to 90 % B in 3.4 min
Flow rate	1.0 mL/min
Pressure	50-120 bar
Detection	UV 230 nm
Temperature	ambient
Injection volume	0.2 µL
Sample	1. Phenylephrine 2. Tripelenamine 3. Pyrilamine 4. Chlorpheniramine 5. Brompheniramine 6. Chloropyramine 7. Diphenhydramine 8. Promethazine 9. Loratadine 10. Meclizine

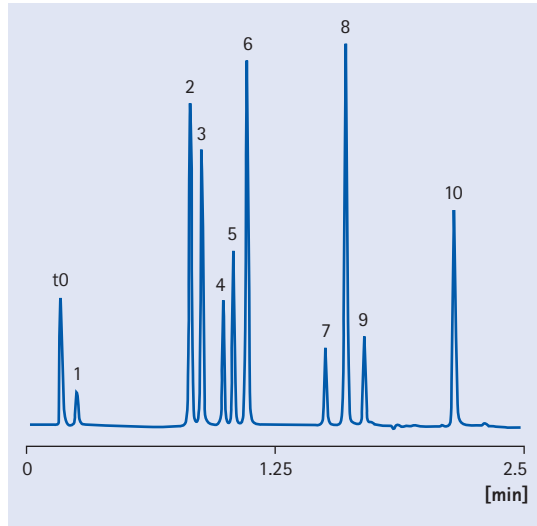



Fast separations: Carotenoids of Salmon Chromolith® Flash RP-18e 25-2 mm

Column	Chromolith® Flash RP-18 endcapped 25-2 mm		
Mobile phase	A: Acetonitrile B: Water + 0.1 % Formic acid		
Gradient	Time [min]	% ACN	% Water
	0	90	10
	3	50	50
Flow rate	1.14 mL/min		
Pressure	22-53 bar		
Detection	436 nm 11 µL flow cell		
Temperature	ambient		
Injection volume	5 µL		
Sample	1) Astaxanthin (cis + trans) 2) Canthaxanthin cis + trans dissolved in Acetonitrile/Water + 0.1 % Formic acid 2/1		

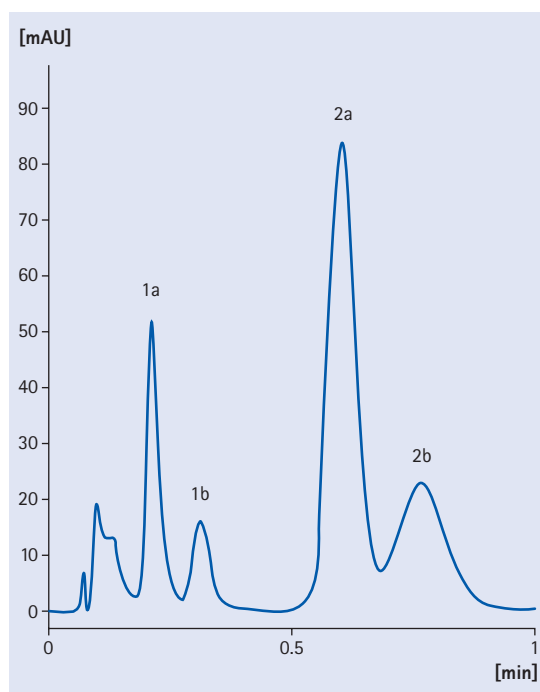

UHPLC system with
Chromolith® Performance RP-18e 100-2 mm
Bioflavonoid separation

Column	Chromolith® Performance RP-18 endcapped 100-2 mm			
Mobile phase	A: 0.1 % TFA in H ₂ O B: MeOH			
Gradient	t	A	B	flow
	[min]	[%]	[%]	[mL/min]
	0.0	85	15	0.50
	2.5	50	50	0.50
	5.0	50	50	0.50
	5.1	85	15	0.50
	8.5	85	15	0.50
Detection	220 nm UV			
Temperature	ambient			
Injection volume	0.5 µL			
Sample	1. Isoquercetin 2. Troxerutin 3. Naringin 4. Morin 5. Quercetin 6. Trihydroxyethyl Luteolin			

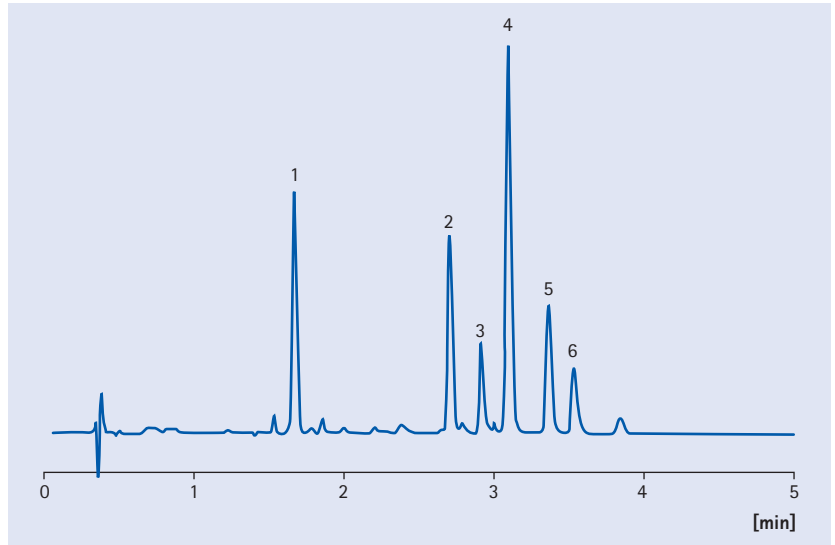

Application: Proteomics
Chromolith® Performance RP-18e 100-2 mm

Column	Chromolith® Performance RP-18 endcapped 100-2 mm
Mobile phase	A: 95 % H ₂ O/5 % ACN/0.1 % TFA (v/v/v) B: 5 % H ₂ O/95 % ACN/0.085 % TFA (v/v/v)
Gradient	from 5 % B to 50 % B in 20 min
Flow rate	0.3 mL/min
Detection	UV 214 nm
Sample	1 µL BSA digest (1mg/mL)

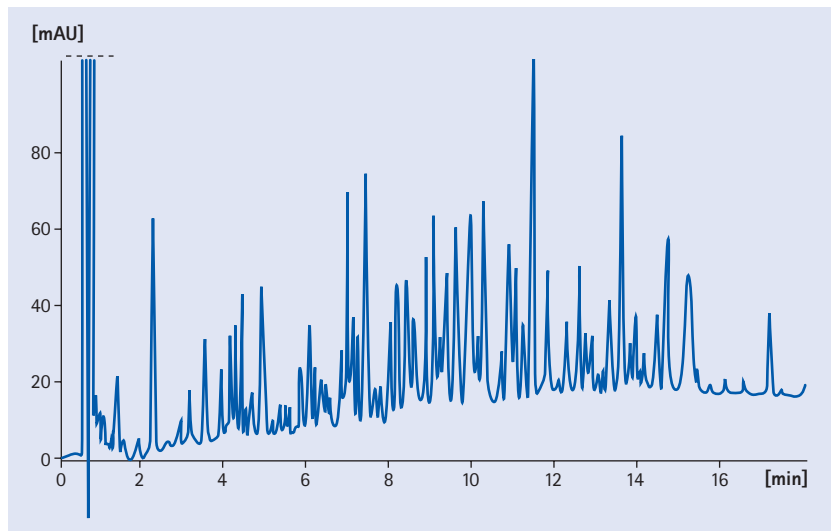

Chromolith® RP-8 endcapped

The Chromolith® RP-8 endcapped HPLC columns offer all the benefits of the monolithic silica technology for reversed phase chromatography:

- high throughput at high flow rates with the best overall column quality
- the possibility of flow gradients
- added column performance by column coupling
- a rigid structure for a longer lifetime
- less matrix-sensitivity

In contrast to the most commonly used reversed phase columns, the Chromolith® RP-18 endcapped, the Chromolith® RP-8 endcapped with its shorter alkyl chain offers less retention and a slightly different selectivity. Therefore it is possible that a baseline separation can be achieved on the RP-8 endcapped bonded column whereas no separation at all is observed under identical elution conditions on a RP-18 endcapped bonded silica column.

Specifications of Chromolith® RP-8 endcapped

Silica type	High-purity	
Particle size	Monolithic	
Macropore size	HR 1.15 µm	Performance 2 µm
Mesopore size	HR 15 nm (150 Å)	Performance 13 nm (130 Å)
Pore volume	1 mL/g	
Total porosity	>80 %	
Surface area	300 m ² /g	
Surface modification	RP-8 endcapped	
Carbon content	11 %	

Ordering information – Chromolith® RP-8 endcapped

Product	Ordering No.	Dimension length	Dimension diameter	Contents of one package
Chromolith® HR RP-8 endcapped	1.52064.0001	100 mm	4.6 mm	1 piece
Chromolith® Performance RP-8 endcapped	1.51468.0001	100 mm	4.6 mm	1 piece

▶ Chromolith® CapRod®
Monolithic capillary
page 201

▶ Chromolith® RP-18
endcapped Chromolith®
RP-18 endcapped columns are the fastest C18
columns in the world.
page 214

▶ Chromolith® Si
page 238

▶ Chromolith®
guard cartridges and
cartridge kit
page 243

▶ Chromolith® column
coupler
page 248

▶ Chromolith® SemiPrep
Perfect scale-up from
analytical to preparative
LC
page 250

Separation examples on Chromolith® Performance RP-8 endcapped 100-4.6 mm

Column	Chromolith® Performance RP-8 endcapped, 100-4.6 mm		
Mobile phase	A: Acetonitrile/ water 90/ 10 + 0.1 % TFA B: 0.1 % TFA in water		
Gradient	Time [min]	% A	% B
	0.0	45	55
	1.0	90	10
	3.0	90	10
Flow rate	2 mL/min		
Pressure	30 – 40 bar		
Detection	214 nm		
Temperature	ambient		
Injection volume	30 µL		
Sample	1. (Sar1, Ala8)-Angiotensine II	87 µg/mL	
	2. (Sar1, Ile8)-Angiotensine II	87 µg/mL	
	3. Angiotensine I	47 µg/mL	

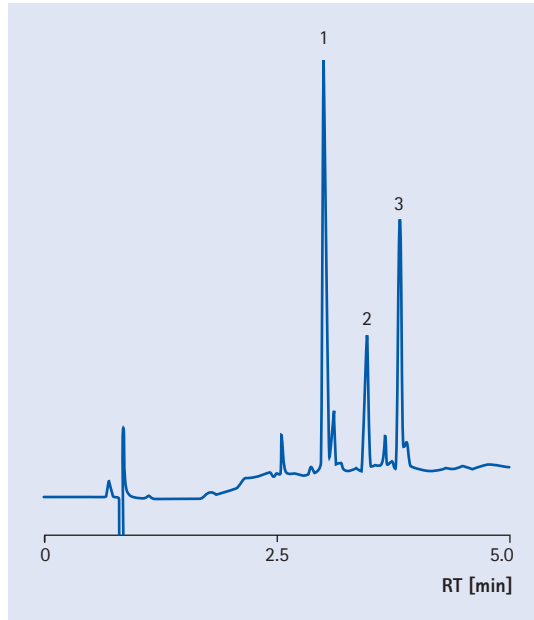

Benzalkonium Chloride Homologs Chromolith® Performance RP-8 endcapped

Column	Chromolith® Performance RP-8 endcapped, 100-4.6 mm
Mobile phase	Dissolve 3.56 g of Disodium phosphate dihydrate in 1000ml milliQ water. Adjust pH to 2.8 with ortho-phosphoric acid. Mix buffer and Acetonitrile 50:50 (v/v)
Flow rate	1.0 mL/min
Pressure drop	26 bar (377 psi)
Detection	210 nm
Cell	10 µL
Temperature	ambient
Injection volume	50 µL
Standard	Weigh 50 mg benzalkonium chloride 10 % working standard and dilute to 20 mL with diluent. Further dilute 2 mL of this solution to 100 mL with diluent.
Sample	Weigh 1 g eye ointment in 20 mL volumetric flask. Add about 15 mL diluent Heat on water bath till completely dispersed. Vortex for 5 minutes. Cool to room temperature and dilute upto the mark with diluent and mix. Allow the mixture to settle for 20 minutes and inject supernatant clear liquid.
Compound	1. BKC Homolog A 2. BKC Homolog B 3. Placebo

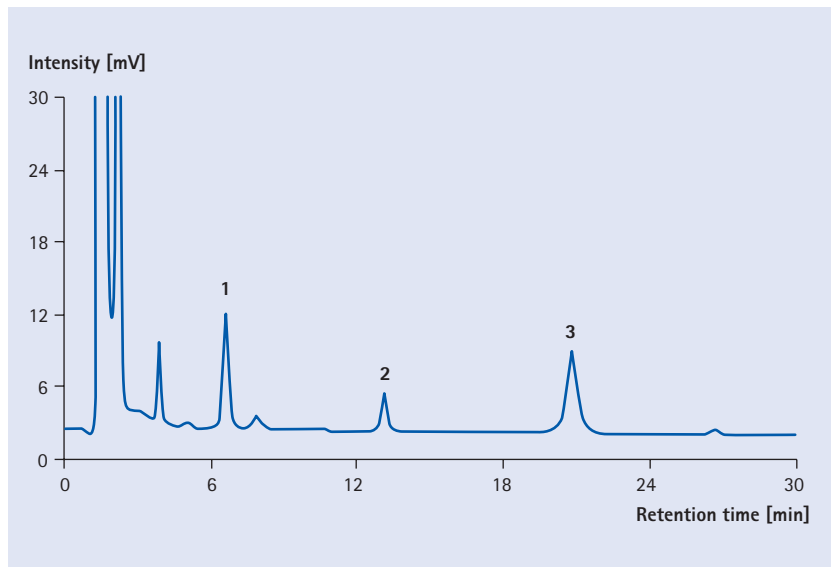

Chromolith® Phenyl

Due to their π - π interactions, Chromolith® Phenyl HPLC columns offer greater selectivity towards aromatic ring-containing compounds than standard alkyl phases. These columns are ideal for the separation of aromatic compounds, flavonoids, fatty acids, PAH, preservatives, purines and pyrimidines and possesses with all of the benefits of the monolithic silica technology:

- high throughput at high flow rates with the best overall column quality
- the possibility of flow gradients
- added column performance by column coupling
- a rigid monolithic structure for a longer lifetime
- less matrix-sensitivity

Specifications of Chromolith® Phenyl

Silica type	High-purity
Particle size	Monolithic
Macropore size	2 μ m
Mesopore size	13 nm (130 Å)
Pore volume	1 mL/g
Total porosity	>80 %
Surface area	300 m ² /g
Surface modification	propyl-Phenyl
Carbon content	11 %

Ordering information – Chromolith® Phenyl

Product	Ordering No.	Dimension length	Dimension diameter	Contents of one package
Chromolith® Phenyl	1.52058.0001	100 mm	4.6 mm	1 piece
Chromolith® Phenyl	1.52057.0001	50 mm	4.6 mm	1 piece
Chromolith® Phenyl	1.52056.0001	25 mm	4.6 mm	1 piece

Separation of alkylphenones using ACN Chromolith® Phenyl 100–4.6 mm

Column	Chromolith® Phenyl 100–4.6 mm
Mobile phase	A: ACN / B: H ₂ O
Gradient	0 min 22 % A 15 min 85 % A 5 min 95 % A
Flow rate	2 mL/min
Detection	UV 254 nm, response time 0.1 s
Injection volume	2 µL
Sample	1. Thiourea 2. Acetanillide 3. Acetophenone 4. Propionphenone 5. Butyrophenone 6. Benzophenone 7. Valerophenone 8. Hexanophenone 9. Heptanophenone dissolved in 100 mL Methanol/Water 90/10

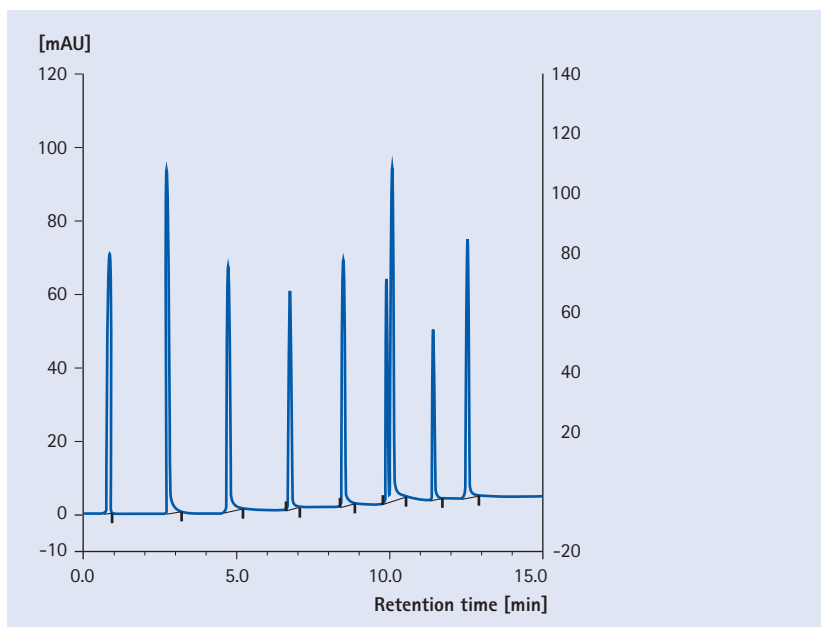

Chromolith® Phenyl 100–4.6 mm

Column	Chromolith® Phenyl 100–4.6 mm
Mobile phase	A: ACN / B: H ₂ O
Gradient	0 min 40 % A 60 % B 2.5 min 95 % A 5 % B 5 min 95 % A 5 % B
Flow rate	2 mL/min
Detection	UV 240 nm, response time 0.1 s
Injection volume	1 µL
Sample	1. Fluoxymesterone 2. Boldenone 3. Methandrostenolone 4. Testosterone 5. Methyltestosterone 6. Boldenone acetate 7. Testosterone acetate 8. Nandrolone acetate 9. Testosterone propionate 10. Nandrolone phenylpropionate 11. Testosterone isocaproate in 100 mL ACN/Water

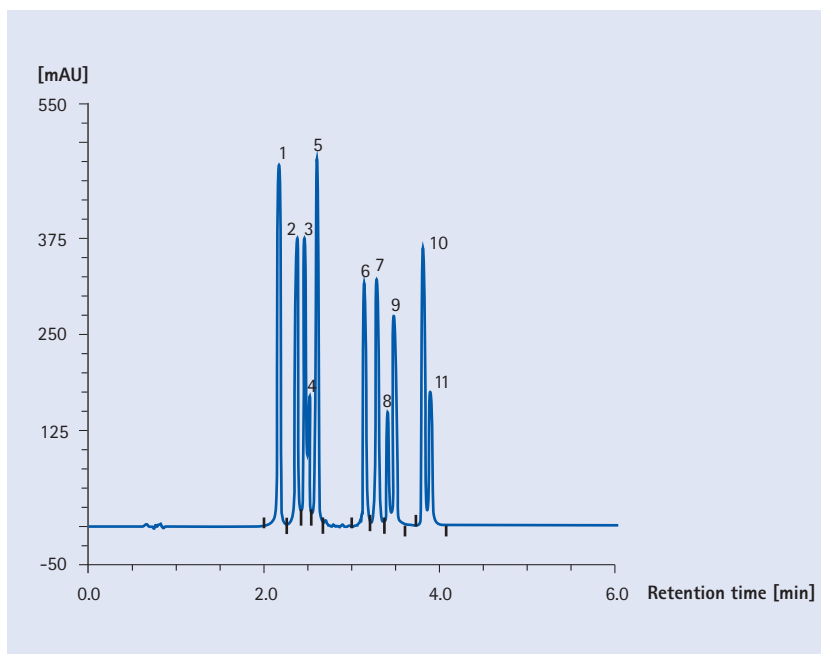

Chromolith® CN

Cyano columns are generally more polar than traditional alkyl silica columns. The functional groups are highly ordered, reducing steric hindrance for the solute. The modification also allows cation exchange activity, which is higher at neutral pH than in acidic conditions. Chromolith® CN columns are suitable for the separation of alkaloids, oils, flavonoids, glycols, phenols, phthalates, steroids and sulfonamides and possess all of the benefits of the monolithic silica technology:

- high throughput at high flow rates with the best overall column quality
- the possibility of flow gradients
- added column performance by column coupling
- a rigid monolithic structure for a longer lifetime
- less matrix-sensitivity

Specifications of Chromolith® CN

Silica type	High-purity
Particle size	Monolithic
Macropore size	2 µm
Mesopore size	13 nm (130 Å)
Pore volume	1 mL/g
Total porosity	>80 %
Surface area	300 m ² /g
Surface modification	Nitrile groups
Carbon content	11 %

Ordering information – Chromolith® CN

Product	Ordering No.	Dimension length	Dimension diameter	Contents of one package
Chromolith® CN	1.52048.0001	100 mm	4.6 mm	1 piece
Chromolith® CN	1.52047.0001	50 mm	4.6 mm	1 piece
Chromolith® CN	1.52046.0001	25 mm	4.6 mm	1 piece

Separation example: Five estrogens

Chromolith® CN 100–4.6 mm

Column	Chromolith® CN 100–4.6 mm	
Mobile phase	Methanol/0.1 % TFA 30/70 v/v	
Flow rate	2.0 mL/min	
Detection	220 nm	
Cell volume	11 µL	
Temperature	ambient	
Injection volume	5 µL	
Sample	1. Estriol	9.4 mg/mL
	2. Estradiol	8.7 mg/mL
	3. Testosterone	11.6 mg/mL
	4. Ethynylestradiol	7.9 mg/mL
	5. Estrone	13.3 mg/mL
	solved in 100 mL ACN/H ₂ O 5/5	

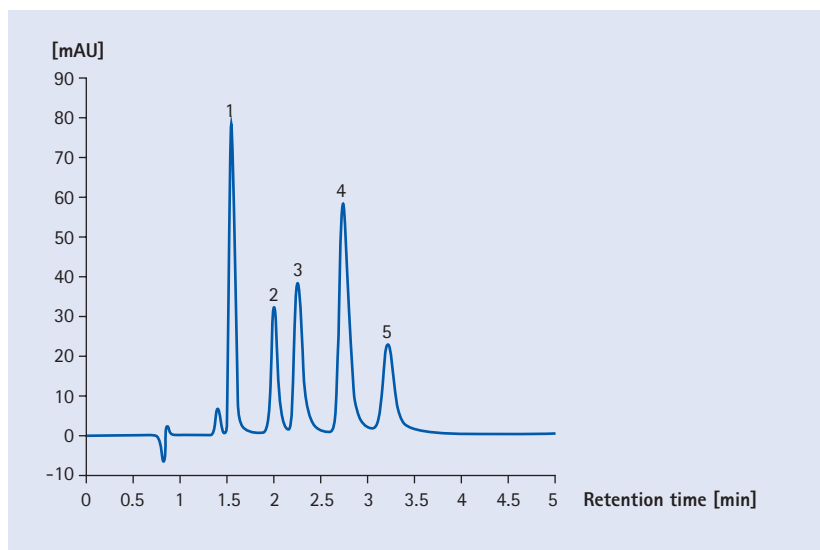

Application: Five peptides

Chromolith® CN 100–4.6 mm

Column	Chromolith® CN 100–4.6 mm	
Mobile phase	Acetonitrile + 0.04 % TFA/H ₂ O + 0.04 % TFA 5/95 v/v	
Flow rate	2.0 mL/min	
Detection	220 nm	
Cell volume	11 µL	
Temperature	30°C	
Injection volume	2 µL	
Sample	1. Gly-Tyr	0.5 mg/mL
	2. Val-Tyr-Val	0.5 mg/mL
	3. Met enkephalin	0.5 mg/mL
	4. Leu enkephalin	0.5 mg/mL
	5. Angiothensin II	0.5 mg/mL
	solved in 1 mL ACN	

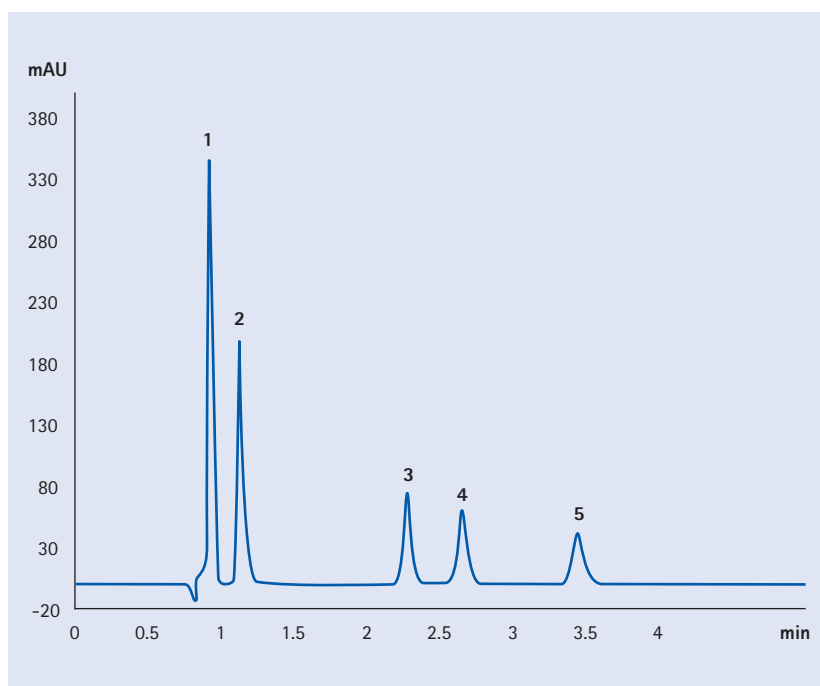

Chromolith® DIOL

Chromolith® DIOL columns are more versatile than bare silica columns, and often offer improved reproducibility. The bonded phase's hydroxyl groups provide good selectivity without excessive retention. This is due to weaker hydrogen bonding with diol groups than with silanols on a bare silica surface. In aqueous phases, the diol phase can effectively shield the silica surface from interacting with proteins. DIOL columns are commonly used for the separation of steroids and sterols under normal-phase conditions. Chromolith® DIOL columns are suitable for the separation of alcohols, amino acids, carotinoids, oils, glycols, preservatives, proteins, sugars, sulfonamides, and water-soluble vitamins and possesses with all of the benefits of the monolithic silica technology:

- high throughput at high flow rates with the best overall column quality
- the possibility of flow gradients
- added column performance by column coupling
- a rigid monolithic structure for a longer lifetime
- less matrix-sensitivity

Specifications of Chromolith® DIOL

Silica type	High-purity
Particle size	Monolithic
Macropore size	2 µm
Mesopore size	13 nm (130 Å)
Pore volume	1 mL/g
Total porosity	>80 %
Surface area	300 m ² /g
Surface modification	Diol
Carbon content	11 %

Ordering information – Chromolith® DIOL

Product	Ordering No.	Dimension length	Dimension diameter	Contents of one package
Chromolith® DIOL	1.53172.0001	100 mm	4.6 mm	1 piece
Chromolith® DIOL	1.53171.0001	50 mm	4.6 mm	1 piece
Chromolith® DIOL	1.53170.0001	25 mm	4.6 mm	1 piece

Separation example: Anisole
Chromolith® DIOL 100–4.6 mm

Column	Chromolith® DIOL 100–4.6 mm	
Mobile phase	n-Heptane/Dioxane 95/5 v/v	
Flow rate	1.3 mL/min	
Detection	254 nm	
Cell volume	11 µL	
Temperature	ambient	
Injection volume	5 µL	
Sample	1. Anisole	390 µg/mL
	2. 3-Nitroanisole	70 µg/mL
	3. 4-Nitroanisole	260 µg/mL
	4. 2-Nitroanisole	180 µg/mL

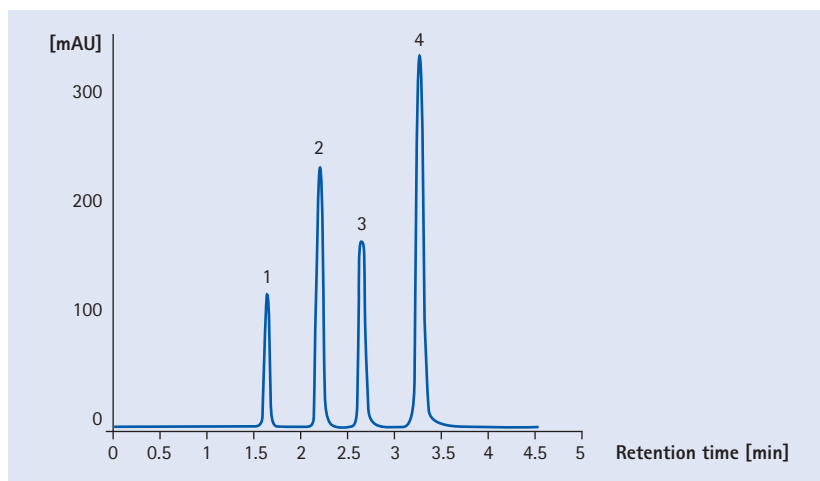

Nitro-aromatic compounds
Chromolith® DIOL 100–4.6 mm

Column	Chromolith® DIOL 100–4.6 mm	
Mobile phase	n-Heptane/Dioxane 99/1 v/v	
Flow rate	1.3 mL/min	
Detection	254 nm	
Cell volume	11 µL	
Temperature	ambient	
Injection volume	5 µL	
Sample	1. Toluole	135.5 mg
	2. 2-Nitrotoluole	12.4 mg
	3. 2-Nitroanisole	28.4 mg
	solved in 100 mL H/D 95/5	

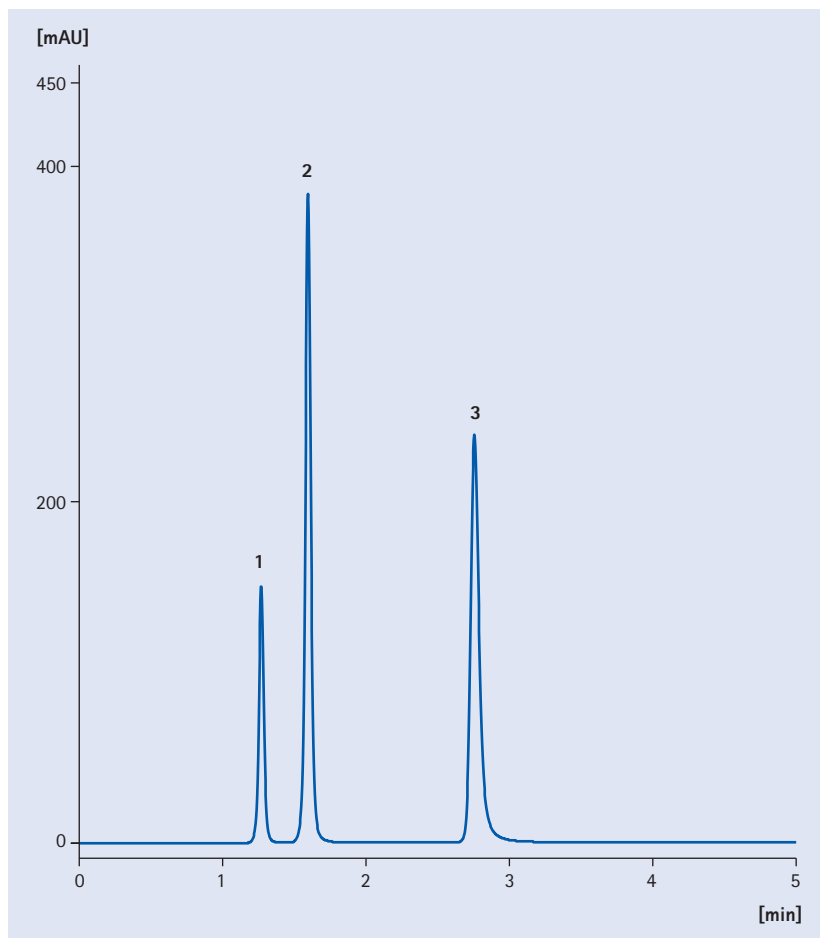

Chromolith® Si

Based on a high-purity silica, Chromolith® Si has been developed as a monolithic normal-phase material suitable for separating polar non-ionic organic compounds, but with all of the benefits of the monolithic silica technology:

- high throughput at high flow rates with the best overall column quality
- the possibility of flow gradients
- added column performance by column coupling
- a rigid monolithic structure for a longer lifetime
- less matrix-sensitivity



▶ **Chromolith® CapRod®**
Monolithic capillary
page 201

▶ **Chromolith® RP-18 endcapped** Chromolith® RP-18 endcapped columns are the fastest C18 columns in the world.
page 214

▶ **Chromolith® RP-8 endcapped**
page 230

▶ **Chromolith® guard cartridges and cartridge kit**
page 243

▶ **Chromolith® column coupler**
page 248

▶ **Chromolith® SemiPrep**
Perfect scale-up from analytical to preparative LC
page 250

▶ **Chromolith® Prep**
Chromolith® – increase in speed, efficiency and productivity
page 254

Specifications of Chromolith® Si

Silica type	High-purity
Particle size	Monolithic
Macropore size	2 µm
Mesopore size	13 nm (130 Å)
Pore volume	1 mL/g
Total porosity	>80 %
Surface area	300 m ² /g

Ordering information – Chromolith® Si

Product	Ordering No.	Dimension length	Dimension diameter	Contents of one package
Chromolith® Performance Si	1.51465.0001	100 mm	4.6 mm	1 piece

Separation examples on Chromolith® Performance Si 100–4.6 mm

Column	Chromolith® Performance Si 100–4.6 mm	
Mobile phase	n-Heptane/Dioxane 95/5 v/v	
Flow rate	2 mL/min	
Pressure	14 bar	
Detection	254 nm	
Temperature	ambient	
Injection volume	5 µL	
Sample	1. Anisole	0.39 mg/mL
	2. 3-Nitroanisole	0.07 mg/mL
	3. 4-Nitroanisole	0.26 mg/mL
	4. 2-Nitroanisole	0.18 mg/mL

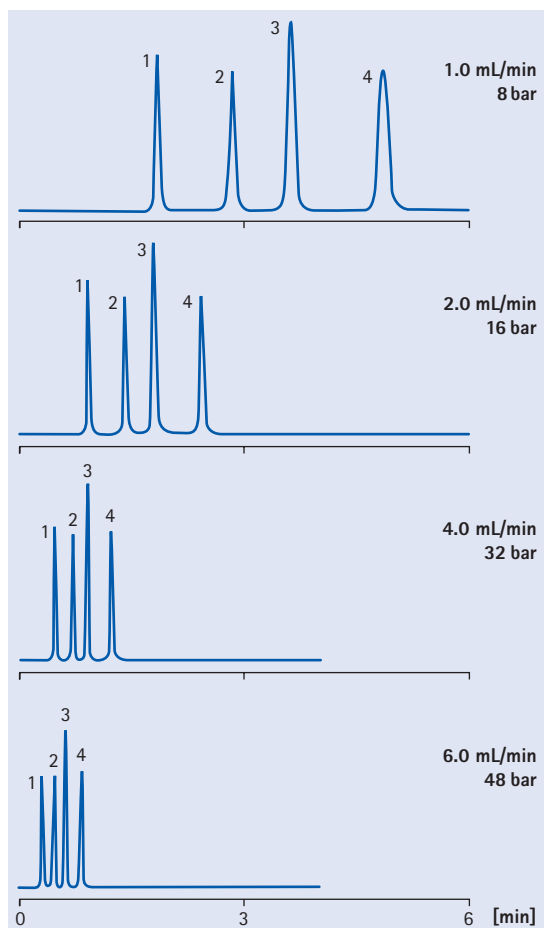

Chromolith® Performance Si 100–4.6 mm

Column	Chromolith® Performance Si 100–4.6 mm	
Mobile phase	n-Heptane/Dioxane 95/5 v/v	
Flow rate	2 mL/min	
Pressure	14 bar	
Detection	254 nm	
Temperature	ambient	
Injection volume	10 µL	
Sample	1. Toluene	0.16 mg/mL
	2. Nitrobenzene	0.02 mg/mL
	3. 2,3-Dimethylantraquinone	0.02 mg/mL
	4. 2-Nitroacetanilide	0.10 mg/mL

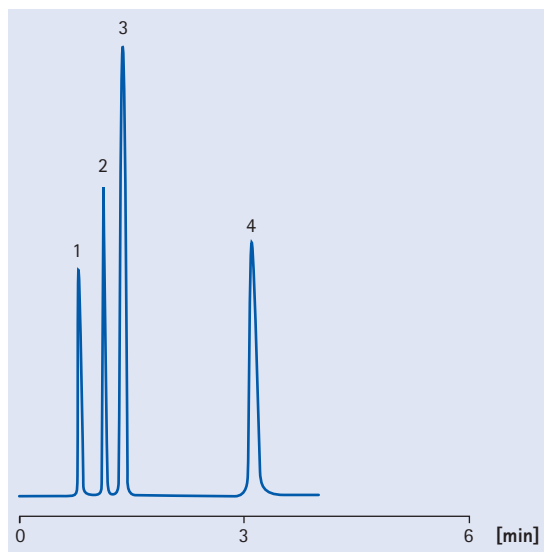

Chromolith® NH₂

Aminopropyl-modified Chromolith® columns in terms of polarity lie between bare silica (normal-phase chromatography) and reversed-phase silica (reversed-phase chromatography) also can already be used as an ion-exchanger. In acidic solutions the NH₂-groups are protonated (-NH₃⁺ X⁻) and therefore display the characteristics of a weak anion exchanger. Medium polar Chromolith® NH₂ column possess hydrophilic as well as hydrophobic properties and can be used under both reversed-phase and normal phase conditions. Retention however, is weaker than on silica and on RP-supports.

Chromolith® NH₂ columns are made of highly porous monolithic rods of silica with a revolutionary bimodal pore structure, therefore high separation efficiencies are reached under low back-pressures. Chromolith® NH₂ column have long lifetimes within pH range of 2.5 to 7.5, high matrix tolerance and speed of analysis.

The major application area for amino-phases is the separation of carbohydrates (mono- and disaccharides such as fructose, glucose, sucrose, maltose, and lactose), anions and organic acids. These columns may be used for normal phase chromatography, reversed phase chromatography, and weak anion exchange separations.

Specifications of Chromolith® NH₂

Silica type	High-purity
Particle size	Monolithic
Macropore size	2 µm
Mesopore size	13 nm (130 Å)
Pore volume	1 mL/g
Total pore volume	3.2 mL/g
Surface area	300 m ² /g
Surface modification	aminopropyl

Ordering information – Chromolith® NH₂

Product	Ordering No.	Dimension length	Dimension diameter	Contents of one package
Chromolith® Performance NH ₂	1.52028.0001	100 mm	4.6 mm	1 piece
Chromolith® SpeedROD NH ₂	1.52027.0001	50 mm	4.6 mm	1 piece
Chromolith® Flash NH ₂	1.52026.0001	25 mm	4.6 mm	1 piece

Separation examples on Chromolith® Performance NH₂ 100–4.6 mm

Column	Chromolith® Performance NH ₂ 100–4.6 mm	
Mobile phase	A: 100 % Acetonitrile (v/v) B: 100 % Water (v/v) C: 0.05 M Phosphat buffer pH 4.6 (v/v)	
Gradient	Initial composition: 86 % A + 9 % B + 5 % C	for 2 min
	Change to: 80 % A + 10 % B + 10 % C	in 1 min
	Hold	until 10 min
Flow rate	1 mL/min	
Pressure	24–28 bar (2.8 MPa, 406 psi)	
Detection	Dionex Ultimate 3000 VWD–3400, 2.5 Hz, response time 0.1s, UV = 265 nm 11 µL flow cell	
Temperature	25°C	
Injection volume	5 µL	
Sample	1. Uracil-β-D-arabinofuranoside 2. Uridine 3. Cytosine-β-D-arabinofuranoside 4. Cytidine	

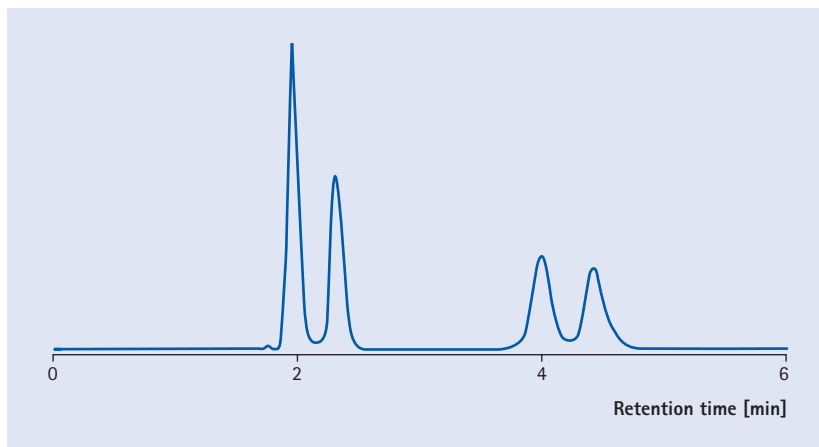

Chromolith® Performance NH₂ 100–4.6 mm

Column	Chromolith® Performance NH ₂ 100–4.6 mm	
Mobile phase	A: 100 % Acetonitrile (v/v) B: 100 % Water (v/v) C: 20 mM Phosphat buffer pH 3.0 (v/v)	
Isocratic	Initial composition: 85 % A / 5 % B / 10 % C v/v/v isocratic	
Flow rate	4 mL/min	
Pressure	100 bar (10 MPa, 145 psi)	
Detection	Dionex Ultimate 3000 VWD–3400, 2.5Hz, response time 0.1s, UV 210 nm 11 µL flow cell	
Temperature	40°C	
Injection volume	1 µL	
Sample	1. Norepinephrine 2. Epinephrine tartrate 3. Dopamine 4. DOPA 5. Norephedrine 6. N-Methylephedrine	

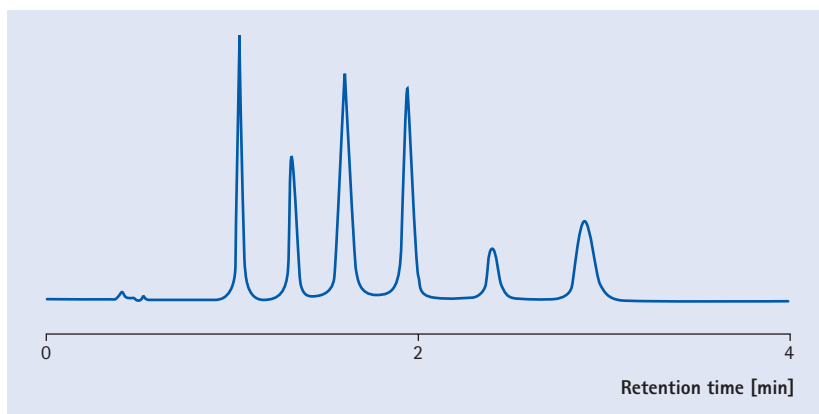

Linear Oligosaccharides

Chromolith® Performance NH₂ 100–4.6 mm

Column	Chromolith® Performance NH ₂ 100–4.6 mm	
Mobile phase	Acetonitrile and water 65:35 (v/v)	
Flow rate	1.0 mL/min	
Pressure drop	26 bar (377 psi)	
Detection	UV 190 nm	
Temperature	23°C	
Injection volume	2 µL	
Sample	1. Void volume	
	2. Maltose	21.6 mg/mL
	3. Maltotriose	19.5 mg/mL
	4. Maltotetraose	15.7 mg/mL
	5. Maltopentaose	16.2 mg/mL
	6. Maltoheptaose	10.6 mg/mL
	in mobile phase	

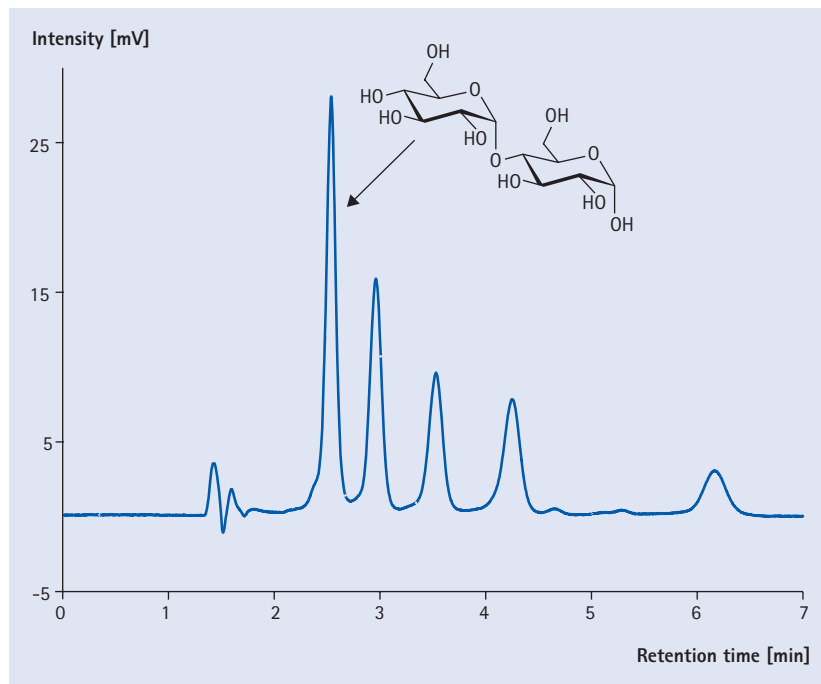

Xylose, Fructose, Glucose and Saccharose

Chromolith® Performance NH₂ 100–4.6 mm

Column	Chromolith® Performance NH ₂ 100–4.6 mm	
Mobile phase	Acetonitrile and water (75:25 v/v)	
Isocratic	Initial composition: 90 % A / 10 % B (v/v)	
Flow rate	1.0 mL/min	
Pressure drop	11 bar (160 psi)	
Detection	UV 190 nm	
Cell	11 µL flow	
Temperature	23°C	
Injection volume	2 µL	
Sample	1. Void volume	
	2. Xylose	2.28 mg/mL
	3. Fructose	6.45 mg/mL
	4. Glucose	9.20 mg/mL
	5. Saccharose	9.42 mg/mL
	diluted in mobile phase.	

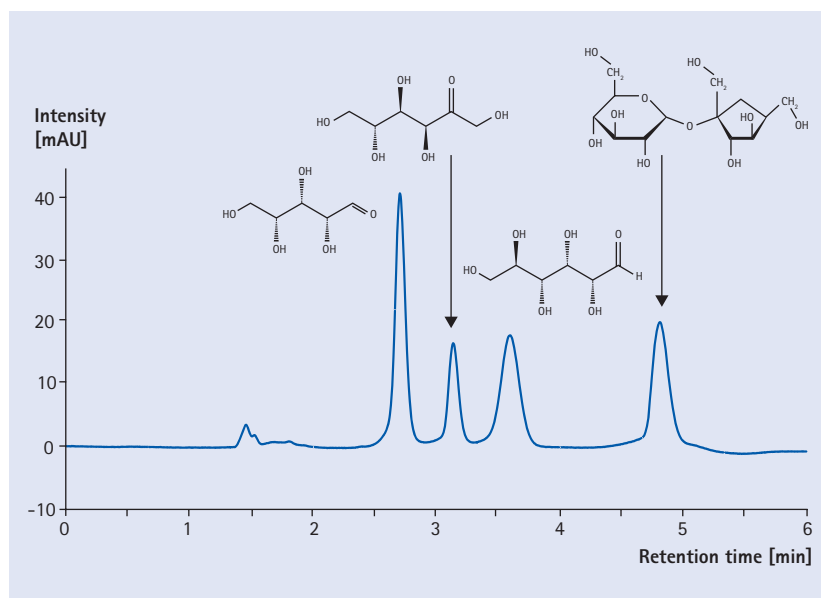

Chromolith® HPLC guard cartridges and cartridge kits

Although monolithic columns are well known for their robustness and longevity, Merck Millipore's Chromolith® guard cartridges and kits further enhance these advantages.

Guard cartridges

Chromolith® HPLC guard cartridges are extremely easy to use. They are simply added directly in front of the main column to protect it from chemical or mechanical contamination. Due to the benefits of monolithic technology, and the convenience of Chromolith® guard columns, they are also popular for use with classical particulate columns. Moreover, guard columns can be used as trap columns when large sample volumes are to be injected. Guard columns should be changed frequently in order to avoid excessive accumulation of impurities.

Guard cartridge starter kit

The Chromolith® guard cartridge kit includes everything needed to significantly enhance the lifetime of monolithic columns: a guard cartridge holder, and three guard cartridges.



For maximum convenience and flexibility, guard cartridges are available in six dimensions with corresponding holders made of PEEK or stainless steel, having different maximum back-pressures.

Guard cartridge holder type	Material holder is made of	Max. back-pressure	How to tighten holder	Guard cartridge i.d.	Guard cartridge length
a)	PEEK	200 bar (2940 psi)	Finger-tight	2 and 3 mm	5 mm
b)	Alumina / PEEK	200 bar (2940 psi)	Finger-tight + tool (included)	4.6 mm	5 mm, 10 mm
c)	SS	400 bar (5880 psi)	Finger-tight + tool (not included)	4.6 mm	5 mm, 10 mm
d)	PEEK / SS	150 bar (2205 psi)	Finger-tight + tool (not included)	10 mm	10 mm
e)	PEEK	100 bar (1470 psi)	Finger-tight + tool (included)	25 mm	10 mm

PEEK = Poly Ether Ether Ketone, SS = Stainless Steel

- ▶ **Chromolith® CapRod®**
Monolithic capillary
page 201
- ▶ **Chromolith® RP-18 endcapped** Chromolith® RP-18 endcapped columns are the fastest C18 columns in the world.
page 214
- ▶ **Chromolith® RP-8 endcapped**
page 230
- ▶ **Chromolith® Si**
page 238
- ▶ **Chromolith® column coupler**
page 248
- ▶ **Chromolith® SemiPrep**
Perfect scale-up from analytical to preparative LC
page 250

Chromolith® HPLC guard cartridges and cartridge kits

Ordering information – Chromolith® guard cartridge holder

Product	Ordering No.	Column length	Column diameter	Type	Contents of one package
Chromolith® guard cartridge holder	1.52033.0001	10 mm	4.6 mm	c *	1 cartridge holder
Chromolith® guard cartridge holder	1.52032.0001	5 mm	4.6 mm	c *	1 cartridge holder

* Guard column type examples and detailed information please find on page 243.

Ordering information – Chromolith® RP-18 endcapped guard cartridges

Product	Ordering No.	Column length	Column diameter	Type	Contents of one package
Chromolith® RP-18 endcapped guard cartridge	1.51452.0001	10 mm	4.6 mm	b/c *	3 guard cartridges
Chromolith® RP-18 endcapped guard cartridge kit	1.51471.0001	10 mm	4.6 mm	b *	1 starter kit with holder and 3 guard cartridges
Chromolith® RP-18 endcapped guard cartridge	1.51451.0001	5 mm	4.6 mm	b/c *	3 guard cartridges
Chromolith® RP-18 endcapped guard cartridge kit	1.51470.0001	5 mm	4.6 mm	b *	1 starter kit with holder and 3 guard cartridges
Chromolith® HighResolution RP-18 endcapped guard cartridge	1.52025.0001	5 mm	4.6 mm	b/c *	3 guard cartridges
Chromolith® HighResolution RP-18 endcapped guard cartridge kit	1.52024.0001	5 mm	4.6 mm	b *	1 starter kit with holder and 3 guard cartridges
Chromolith® RP-18 endcapped guard cartridge	1.52005.0001	5 mm	3 mm	a *	3 guard cartridges
Chromolith® RP-18 endcapped guard cartridge kit	1.52004.0001	5 mm	3 mm	a *	1 starter kit with holder and 3 guard cartridges
Chromolith® RP-18 endcapped guard cartridge	1.52009.0001	5 mm	2 mm	a *	3 guard cartridges
Chromolith® RP-18 endcapped guard cartridge kit	1.52008.0001	5 mm	2 mm	a *	1 starter kit with holder and 3 guard cartridges

* Guard column type examples and detailed information please find on page 243.

Ordering information – Chromolith® RP-8 endcapped guard cartridges

Product	Ordering No.	Column length	Column diameter	Type	Contents of one package
Chromolith® RP-8 endcapped guard cartridge	1.52013.0001	5 mm	4.6 mm	b/c *	3 guard cartridges
Chromolith® RP-8 endcapped guard cartridge kit	1.52012.0001	5 mm	4.6 mm	b *	1 starter kit with holder and 3 guard cartridges

* Guard column type examples and detailed information please find on page 243.

Ordering information – Chromolith® Phenyl guard cartridges

Product	Ordering No.	Column length	Column diameter	Type	Contents of one package
Chromolith® Phenyl guard cartridge	1.52059.0001	5 mm	4.6 mm	b/c *	3 guard cartridges

* Guard column type examples and detailed information please find on page 243.

Ordering information – Chromolith® CN guard cartridges

Product	Ordering No.	Column length	Column diameter	Type	Contents of one package
Chromolith® CN guard cartridge	1.52050.0001	5 mm	4.6 mm	b/c *	3 guard cartridges

* Guard column type examples and detailed information please find on page 243.

Ordering information – Chromolith® DIOL guard cartridges

Product	Ordering No.	Column length	Column diameter	Type	Contents of one package
Chromolith® DIOL guard cartridge	1.53175.0001	5 mm	4.6 mm	b/c *	3 guard cartridges

* Guard column type examples and detailed information please find on page 243.

Ordering information – Chromolith® NH₂ guard cartridges

Product	Ordering No.	Column length	Column diameter	Type	Contents of one package
Chromolith® NH ₂ guard cartridge	1.52030.0001	5 mm	4.6 mm	b/c *	3 guard cartridges
Chromolith® NH ₂ guard cartridge kit	1.52029.0001	5 mm	4.6 mm	b *	1 starter kit with holder and 3 guard cartridges

* Guard column type examples and detailed information please find on page 243.

Ordering information – Chromolith® Si guard cartridges

Product	Ordering No.	Column length	Column diameter	Type	Contents of one package
Chromolith® Si guard cartridge	1.52011.0001	5 mm	4.6 mm	b/c *	3 guard cartridges
Chromolith® Si guard cartridge kit	1.52010.0001	5 mm	4.6 mm	b *	1 starter kit with holder and 3 guard cartridges

* Guard column type examples and detailed information please find on page 243.

Chromolith® HPLC guard cartridges and cartridge kits

Separation examples with and without a precolumn
Chromolith® Performance RP-18e 100-2 mm
with a Chromolith® RP-18e 5-2 mm precolumn

Column	Chromolith® Performance RP-18e 100-2 mm with precolumn Chromolith® RP-18e 5-2 mm	
Mobile phase	Acetonitrile/water 60/40	
Flow rate	0.38 mL/min	
Pressure	20 bar	
Detection	UV 254 nm	
Anthracene	N/m	113540
	T _{USP}	1.14
	K'-value	3.79
Sample	1. Thiourea 2. Biphenyl-2-ol 3. Progesterone 4. Hexanophenone 5. Anthracene	

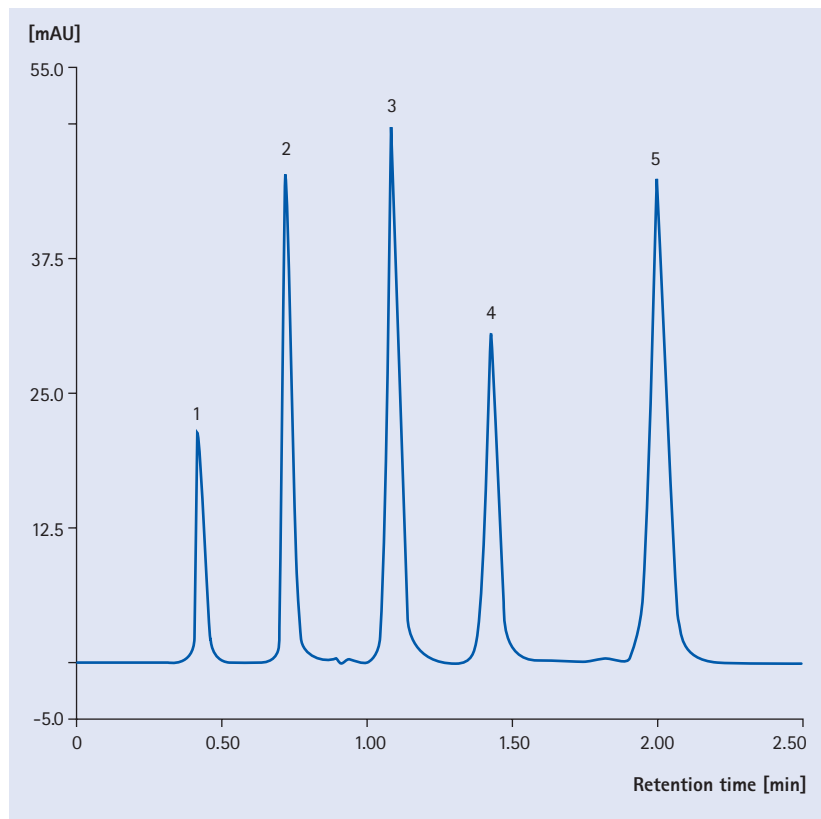

Guard cartridges in 5 mm
and 10 mm length



Chromolith® Performance RP-18e 100-2 mm without a precolumn

Column	Chromolith® Performance RP-18e 100-2 mm without precolumn	
Mobile phase	Acetonitrile/water 60/40	
Flow rate	0.38 mL/min	
Pressure	20 bar	
Detection	UV 254 nm	
Anthracene	N/m	115460
	T _{USP}	1.07
	K'-value	3.90
Sample	<ol style="list-style-type: none"> 1. Thiourea 2. Biphenyl-2-ol 3. Progesterone 4. Hexanophenone 5. Anthracene 	

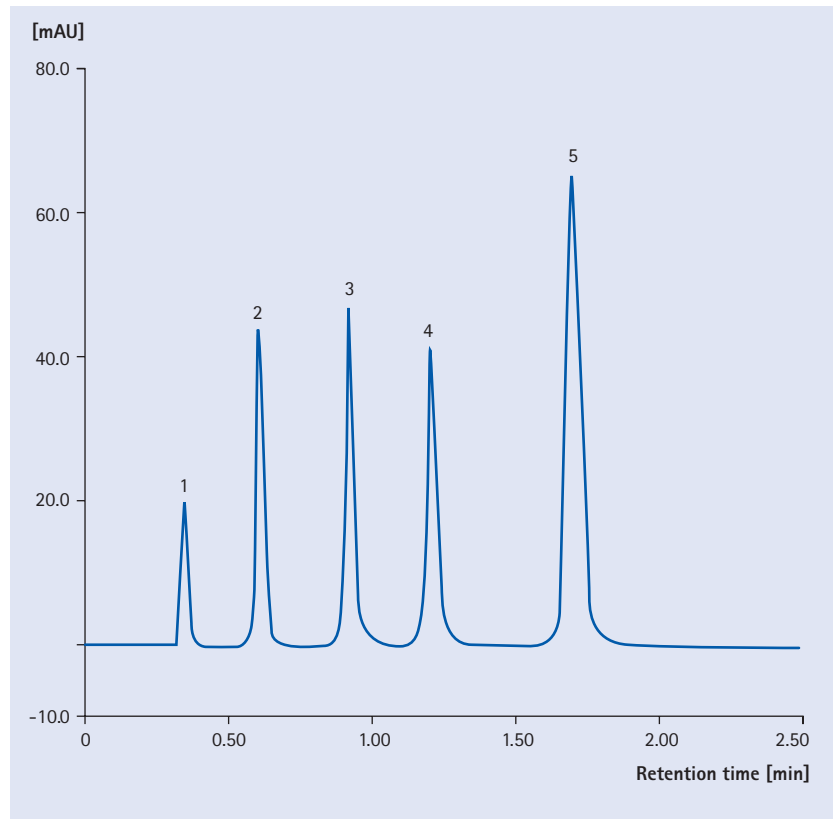

As seen in the examples, guard columns have very little negative effects on the separation. These may include a slight shift in elution time, or a minimal loss in efficiency.

Chromolith® column coupler

Chromolith® Performance RP-18 endcapped columns provide rapid high quality separation of complex mixtures. But, if necessary, the separation efficiency can be increased by coupling several columns together using the Chromolith® column coupler. With the column coupler it is possible to increase the plate count by coupling several columns in series producing a column with a theoretical plate count which is significantly higher compared to any particulate column available, while producing pressures still well below the HPLC system limit. This added column performance is the key to solve even very critical separation problems where resolution is the limiting factor! Therefore they are perfect for use to separate formerly non-separable complex mixtures.

The table below shows the comparison between Chromolith® columns and particulate columns. As you can clearly see, the combination of two Chromolith® Performance RP-18 endcapped columns (linked by a column coupler) will result in a column with a separation efficiency of 19,000 theoretical plates per column, which is usually the maximum for particulate columns.

Typical column efficiency using the Chromolith® column coupler

Column	Length [mm]	Pressure * [bar]	Plate number per column [Anthracene]
Chromolith® Performance 1x	100	30	10,000
Chromolith® Performance 2x	200	60	19,000
Chromolith® Performance 3x	300	90	27,000
Chromolith® Performance 4x	400	120	35,000
Chromolith® Performance 5x	500	150	41,000
Particulate column (5 µm)	250	220	18,500
Particulate column (3.5 µm)	150	400	19,000

Pressure * 3 mL/min 75 % acetonitrile, 25 % water

Ordering information – Chromolith® column coupler

Product	Ordering No.	Contents of one package
Chromolith® column coupler	1.51467.0001	1 column coupler



Column coupler

Application of Chromolith® column coupler 81,000 plates at 85 bar pressure

Column	10 columns of Chromolith® Performance RP-18e, 100-4.6 mm
Mobile phase	80 /20 Acetonitrile/water
Flow rate	1 mL/min
Detection	UV 254 nm
Temperature	ambient
Injection volume	10 µL
Sample	1. Thiourea 2. Benzene 3. Toluene 4. Ethylbenzene 5. Propylbenzene 6. Butylbenzene 7. Penylbenzene

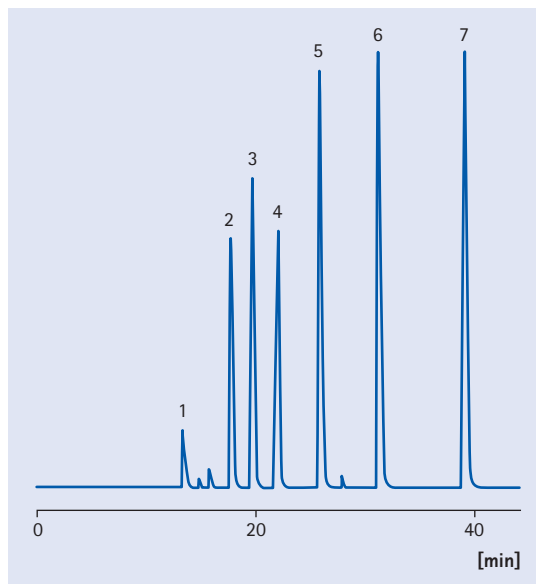

Column coupling: 11 steroids Chromolith® HighResolution RP-18e 2 x 100-4.6 mm / 1 x 50-4.6 mm

Column	Chromolith® HighResolution RP-18e 2 x 100-4.6 mm / 1 x 50-4.6 mm		
Mobile phase	ACN / water		
Gradient	Time [min]	ACN [%]	Water [%]
	0	55	45
	2	95	5
	15	95	5
Flow rate	1 mL/ min		
Column pressure	30 – 68 bar		
LC system	LaChrom® L7000		
Detection	UV = 240 nm		
Vol. detector cell	16 µL		
Temperature	ambient		
Injection volume	10 µL		
Sample	1. Fluoxymesterone 2. Boldenone 3. Methandrostenolone 4. Testosterone 5. Methyltestosterone 6. Boldenone-Acetate 7. Testosterone-Acetate 8. Nandrolone-Propionate 9. Testosterone-Propionate 10. Nandrolone-Phenylpropionate 11. Testosterone-Isocaproate		

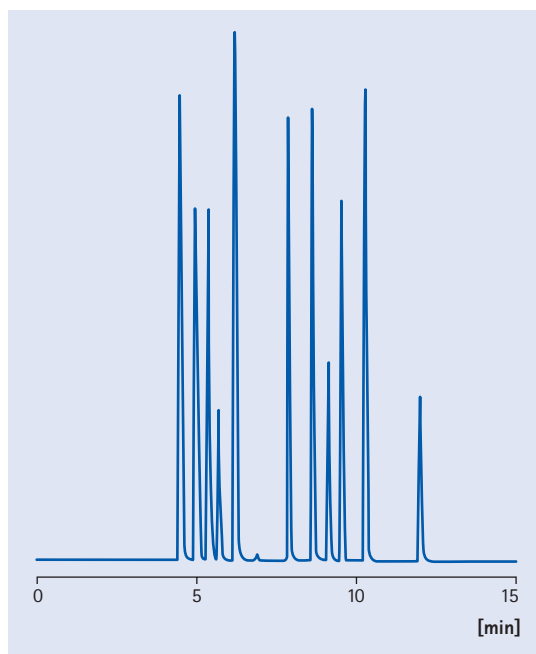

Chromolith® SemiPrep

Perfect scale-up from analytical to preparative LC

Optimum separation at flow rates exceeding 40 mL/min

Chromolith® SemiPrep 10 mm i.d. columns combine high separation speed with very high separation performance. They are the ideal alternative to particulate columns with 10 mm i.d. (and even 21.2 mm). The Chromolith® SemiPrep columns have the same bimodal porous silica rod structure as the Chromolith® analytical columns with 4.6 mm inner diameter. The macropores are 2 µm diameter and the mesopores are 13 nm.

Chromolith® SemiPrep benefits

- Direct scale-up from analytical to semi-prep
- Faster sample throughput at lower operating pressure compared to semi-prep columns packed with 5 µm particles
- Sharp separations, even at high sample loading
- Excellent column lifetime, thanks to rugged monolithic silica structure
- Chromolith® SemiPrep columns are optimized for LC-MS by a surface modification process minimizing column bleed.

Specifications of Chromolith® SemiPrep 100–10 mm

Silica type	High-purity (99.999 %)
Particle size	Monolithic
Macropore size	2 µm
Mesopore size	13 nm (130 Å)
Pore volume	1.0 mL/g
Total porosity	>80 %
Surface area	300 m ² /g
Surface modification	RP-18 endcapped
Selectivity equivalent to	L1 (USP)
Carbon content	18 %
Surface coverage	3.6 µmol/m ²
Mobile phase compatibility	all standard HPLC solvents may be used with the following restrictions
Max. dichloromethane conc.	5 %
Max. tetrahydrofuran conc.	50 %
Max. dimethylsulphoxide DMSO	5 % but OK as sample solvent
pH range	2 – 7.5
Max pressure	150 bar for 10 mm columns
Max temperature	45°C

▶ Chromolith® CapRod®
Monolithic capillary
page 201

▶ Chromolith® RP-18
endcapped Chromolith®
RP-18 endcapped col-
umns are the fastest C18
columns in the world.
page 214

▶ Chromolith® RP-8
endcapped
page 230

▶ Chromolith® Si
page 238

▶ Chromolith®
guard cartridges and
cartridge kit
page 243

▶ Chromolith® column
coupler
page 248

▶ Chromolith® Prep
Chromolith® – increase
in speed, efficiency and
productivity
page 254

Ordering information – Chromolith® SemiPrep 100–10 mm

Product	Ordering No.	Dimension length	Dimension diameter	Contents of one package
Chromolith® SemiPrep Si	1.52015.0001	100 mm	10 mm	1 piece
Chromolith® SemiPrep RP-18 endcapped	1.52016.0001	100 mm	10 mm	1 piece
Chromolith® SemiPrep Si guard cartridge	1.52035.0001	10 mm	10 mm	3 pieces
Chromolith® SemiPrep RP-18 endcapped guard cartridge	1.52036.0001	10 mm	10 mm	3 pieces
Chromolith® SemiPrep guard cartridge holder	1.52037.0001	10 mm	10 mm	1 piece



Optimum separation at flow rates exceeding 40 mL/min

Chromolith® SemiPrep RP-18e 100–10 mm i.d. columns combine high separation speed with very high separation performance. They are the ideal alternative to particulate columns with 10 mm i.d. (and even 21.2 mm).

Separation of a standard mixture

Acetonitrile/water 60/40, Data for anthracene (3rd peak)

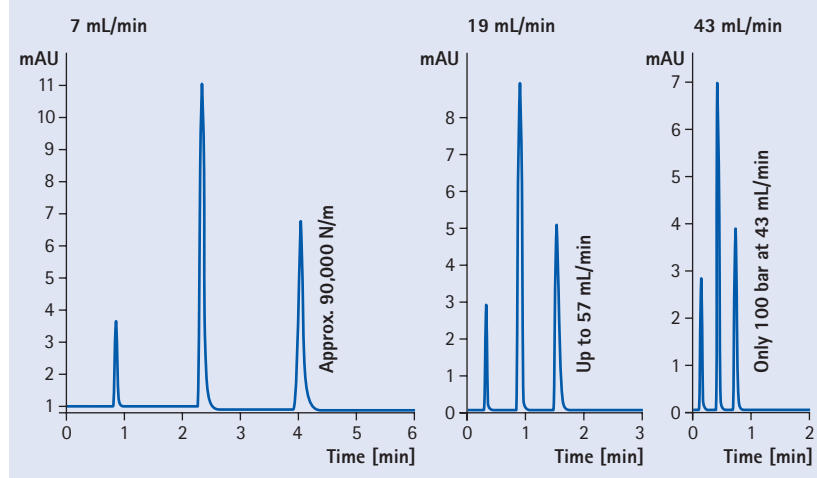

Mobile phase	Acetonitrile/water 60/40
Flow rate	2 mL/min
Detection	UV 254 nm
Temp.	ambient
Injection volume	5 µL
Sample	1. Thiourea 2. Progesterone 3. Anthracene

Accurate scale-up from analytical to preparative columns

25 mg injected onto a Chromolith® SemiPrep RP-18 endcapped column show the same excellent separation when compared with the corresponding analytical column.

Chromolith® Performance RP-18 endcapped 100-4.6 mm

Column	Chromolith® Performance RP-18 endcapped 100-4.6 mm	
Mobile phase	A: Acetonitrile with 0.1 % TFA B: Water with 0.1 % TFA	
Gradient	0 – 10 min	15 – 80 % A
Flow rate	1 mL/min	
Detection	UV 270 nm	
Injection volume	2 µL	
Sample	1. Nadolol	1 mg/mL
	2. Metoprolol	1 mg/mL
	3. Propranolol	0.5 mg/mL

Chromolith® SemiPrep RP-18 endcapped 100-10 mm

Column	Chromolith® SemiPrep RP-18 endcapped 100-10 mm	
Mobile phase	A: Acetonitrile with 0.1 % TFA B: Water with 0.1 % TFA	
Gradient	0 – 10 min 15 – 80 % A	
Flow rate	4.7 mL/min	
Detection	UV 270 nm	
Injection volume	100 µL	
Sample	1. Nadolol	100 mg/mL
	2. Metoprolol	100 mg/mL
	3. Propranolol	50 mg/mL

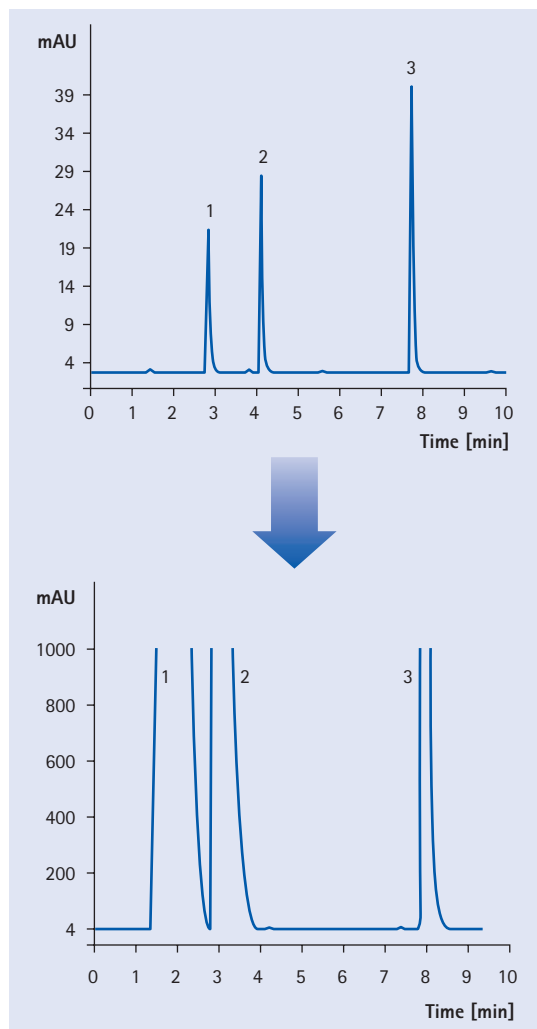

Sample loadability

The sample loadability depends on many factors including the solubility of the sample in the mobile phase.

The following example shows that the sample loadability on the Chromolith® SemiPrep column can exceed 80 mg. Here DMSO is used as solvent.

Chromolith® SemiPrep RP-18 endcapped 100–10 mm

Column	Chromolith® SemiPrep RP-18 endcapped 100–10 mm	
Mobile phase	A: Acetonitrile with 0.05 % TFA B: Water with 0.05 % TFA	
Gradient	0 – 1 min	5 % A
	1 – 5 min	5 – 90 % A
	5 – 5.2 min	95 % A
	5.2 – 6.2 min	95 % A
Flow rate	8 mL/min	
Detection	UV 214 nm	
Injection volume	400 µL	
Sample	1. Propranolol	200 mg/mL
	2. Nifedipine	200 mg/mL
	dissolved in DMSO/Methanol 1/1	

Separation of 80 mg/injection

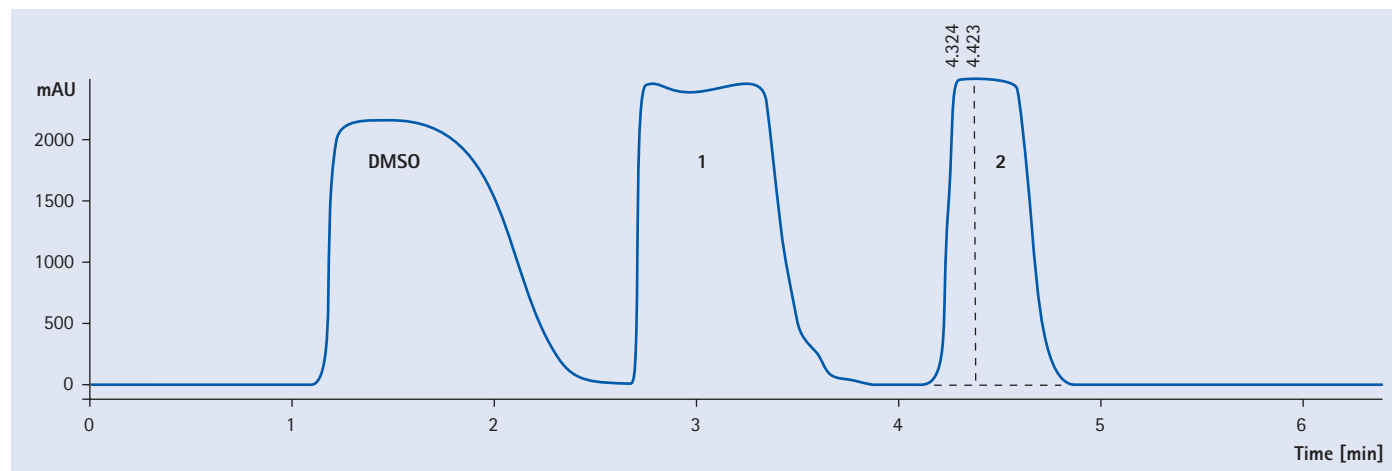

By courtesy of Dr. A. Espada and C. Anta, Lilly Spain

Chromolith® Prep

Chromolith® – increase in speed, efficiency and productivity

Chromolith® Prep monolithic stationary phases are new ultra-pure silica phases. Their special properties are due to a bimodal pore structure. This structure is based on the new "sol-gel" technology and consists of macropores and mesopores.



Ready-to-use Chromolith® Prep column

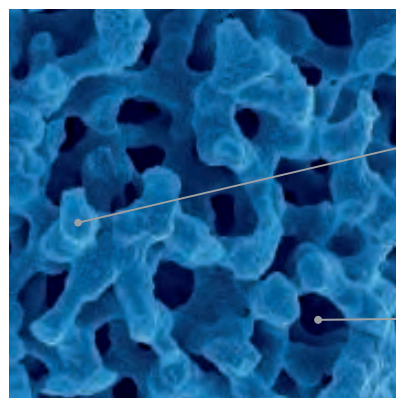

Mesopores and macropores of Chromolith® Prep Si

Mesopores: 13 nm

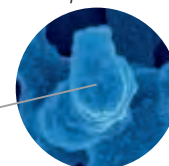

Macropores: 2 µm

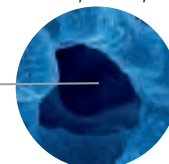

The combination of macro- and mesopores ensures high efficiency as well as high speed. The mesopores with an average diameter of 12 nm form the fine porous structure of the column interior and create a very large surface area on which adsorption of the target compounds occurs. The large macropores with a pore diameter of 3 µm form a dense network of pores and allow a high flow rate due to a low resistance factor. The resulting excellent accessibility of the mesopores (total porosity >80 %) ensures fast adsorption and desorption kinetics due to short diffusion length inside the pores. This results in dramatically reduced separation times providing an essential increase in productivity.

Typical technical data of Chromolith® Prep Si and RP-18e

Macropore size	3 µm
Mesopore size	12 nm (120 Å)
Specific pore volume	1 mL/g
Specific surface area	350 m ² /g
Packing density	0.2 g/mL
Total porosity	0.8
Surface pH	neutral
Dimension	100–25 mm
Maximum operating pressure	100 bar (1450 psi)

► **Chromolith® RP-18 endcapped** Chromolith® RP-18 endcapped columns are the fastest C18 columns in the world.
page 214

► **Chromolith® Si**
page 238

Customer benefits

- Low pressure drop at higher flow rate.
- The higher porosity assures fast adsorption and desorption kinetics.
- In comparison to particulate sorbents, monolithic column ensure shorter separation times which lead to less solvent consumption and shorter separation.
- Higher productivity and greater efficiency compared to particulate sorbents.

Ordering information – Chromolith® Prep Si 100–25 mm and RP–18e 100–25 mm

Product	Ordering No.	Dimension length	Dimension diameter	Contents of one package
Chromolith® Prep Si 100-25 mm	1.25251.0001	100 mm	25 mm	1 piece 2 connectors (1/8" and 1/16")
Chromolith® Prep RP-18e 100-25 mm	1.25252.0001	100 mm	25 mm	1 piece 2 connectors (1/8" and 1/16")
Chromolith® Prep guard cartridge Si 10-25 mm	1.25260.0001	10 mm	25 mm	1 piece
Chromolith® Prep guard cartridge RP-18e 10-25 mm	1.25261.0001	10 mm	25 mm	1 piece

The monolith is clad with a polymeric material (PEEK) and can be connected directly to each HPLC system and used as "ready to use" column.

Ordering information – Chromolith® Prep accessories

Product	Ordering No.	Dimension diameter	Contents of one package
Chromolith® Prep sealing set	1.25254.0001	25 mm	2 O-rings
Chromolith® Prep tool set	1.25255.0001	25 mm	1 mounting tool filter 1 mounting tool 1 hook wrench
Chromolith® Prep end cap set	1.25256.0001	25 mm	1 inlet cap complete 1 outlet cap
Chromolith® Prep frit set	1.25257.0001	25 mm	10 frits
Chromolith® Prep 25 mm column coupler	1.25259.0001	25 mm	1 piece
Chromolith® Prep 25 mm guard cartridge holder	1.25262.0001	25 mm	1 piece

The formula for direct scale-up

An analytical separation can be simply transferred to semi-preparative and preparative columns by linear transfer of methods. The objective of any preparative separation strategy is high sample throughput per unit of time. Therefore, columns are often run under concentration and/or volume overload conditions. The maximum load on the column however, is dependent on the complexity of the separation problem and the nature of the sample.

If working in the linear or the non-linear mode the calculation of the flow rate or injection volume is made according to the equation.

$$\frac{X_{an}}{\pi r_{an}^2} = \frac{X_{pr}}{\pi r_{pr}^2} \cdot \frac{1}{c_L}$$

X_{an}	Flow rate in the analytical system	
X_{pr}	Flow rate in the preparative system	$X_{pr} = X_{an} \cdot r_{pr}^2 \cdot c_L / r_{an}^2$
r_{an}	Radius of analytical column	
r_{pr}	Radius of preparative column	
c_L	Length of the preparative column to length of the analytical column	
M	Substance mass	$M_{pr} = M_{an} \cdot r_{pr}^2 \cdot c_L / r_{an}^2$

Guide values of typical flow rates and loading capacity for the transfer from an analytical to a preparative column

Columns	Column dimension [length/diameter]	Typical flow rate	Loading capacity	Loading volume
Analytical column	100 – 4.6 mm	2 mL/min	5 mg	5 – 50 µL
Preparative column	100 – 25 mm	60 mL/min	150 – 370 mg	100 – 1500 µL

Analytical separation

Chromolith® Performance RP-18e 100-4.6 mm

Column	Chromolith® Performance RP-18e 100-4.6 mm
Mobile phase	A: Water + 0.1 % formic acid B: Acetonitrile
Gradient	linear gradient from 10 % B to 40 % in 14 min
Flow rate	2 mL/min
Detection	UV 254 nm
Sample	0.28 mg Heterocyclic racemate (EMD 53986) in 10 µL DMSO

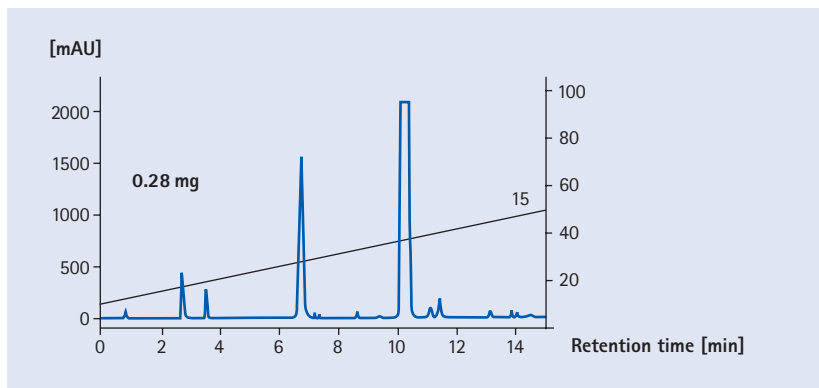

Preparative separation

Chromolith® Prep RP-18e 100-25 mm

Column	Chromolith® Prep RP-18e 100-25 mm
Mobile phase	A: Water + 0.1 % formic acid B: Acetonitrile
Gradient	linear gradient from 10 % B to 40 % in 14 min
Flow rate	60 mL/min
Detection	UV 254 nm
Sample	8.46 mg Heterocyclic racemate (EMD 53986) in 300 µL DMSO

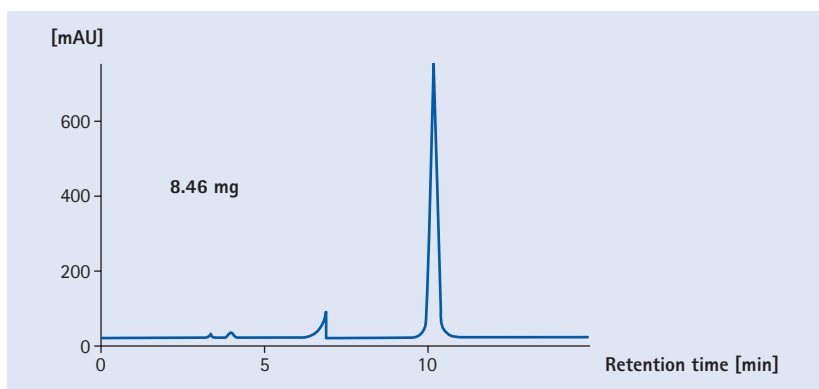

Chromolith® Prep RP-18e 100-25 mm

Column	Chromolith® Prep RP-18e 100-25 mm
Mobile phase	A: Water + 0.1 % formic acid B: Acetonitrile
Gradient	linear gradient from 10 % B to 40 % in 14 min
Flow rate	60 mL/min
Detection	UV 254 nm
Sample	141 mg Heterocyclic racemate (EMD 53986) in 300 µL DMSO

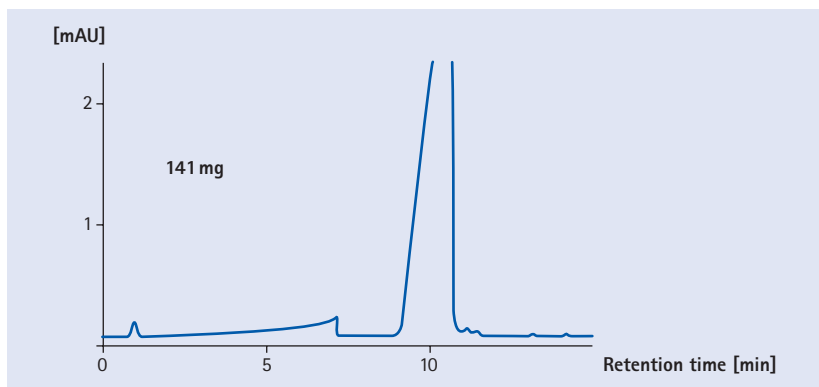

Various applications with Chromolith® Prep monolithic columns – comparison of flow rates

Chromolith® Prep columns can be operated with a flow rate of up to 400 mL/min and pressures of up to 100 bar. This is a tenfold increase of flow rate compared to equivalent size particulate packed columns.

Separation at different flow rates 40 and 390 mL/min Chromolith® Prep Si 100–25 mm

Column	Chromolith® Prep Si 100-25 mm
Solvent	n-Heptane / Dioxane (80/20 v/v)
Flow rate	40 mL/min
Sample	1. Toluene 2. Dimethylphthalate 3. Dibutylphthalate

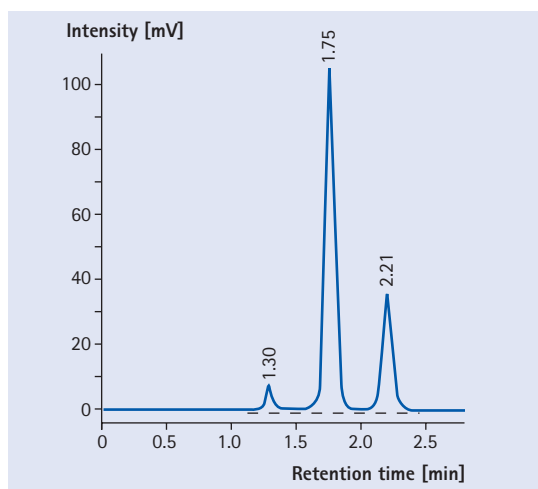

Chromolith® Prep Si 100–25 mm

Column	Chromolith® Prep Si 100-25 mm
Solvent	n-Heptane / Dioxane (80/20 v/v)
Flow rate	390 mL/min
Sample	1. Toluene 2. Dimethylphthalate 3. Dibutylphthalate

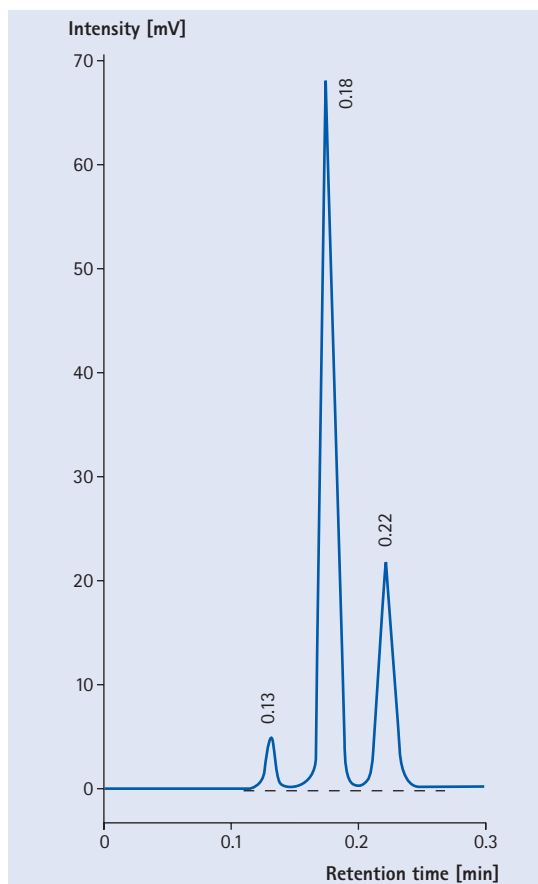

Separation of α - and δ -Tocopherol from sunflower oil at different flow rates

Flow rate 40 mL/min

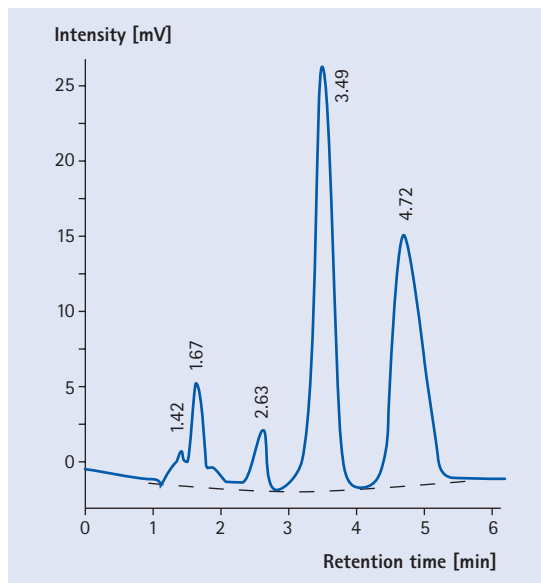

Flow rate 160 mL/min

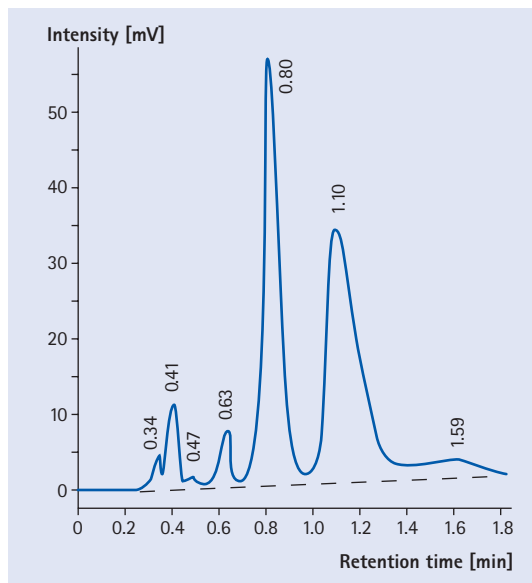

Separation of diastereomers with a productivity of 861 g/d

Chromolith® Prep Si 100–25 mm

Column	Chromolith® Prep Si 100–25 mm
Solvent	n-Heptane / Dioxane (80/20 v/v)
Flow rate	140 mL/min
Injection	249 mg
Cycle time	25 sec
Sample	Fluoro-dihydro-oxyranil-benzopyran

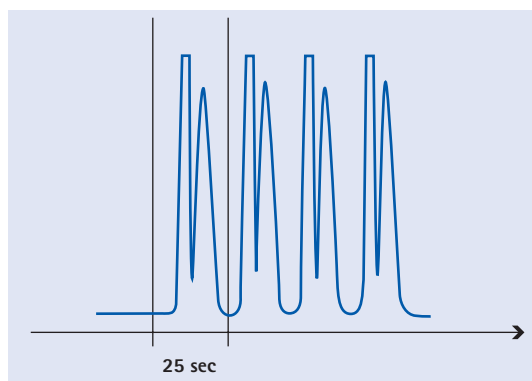

Preparative RP-Chromatography with monolithic columns

The selectivity of a Chromolith® Prep RP-18 endcapped column is comparable to common RP-18 endcapped reversed phase columns. It provides you with an excellent tool to solve your separation problems regarding nonpolar basic and acidic compounds as well as peptides. In most cases your existing methods from using particulate columns can easily be transferred to Chromolith® Prep. However for some applications it is worth optimizing the method to make use of the full potential of this enhanced technology.

Chromolith® Prep RP-18 endcapped 100–25 opens the door to high speed separation in preparative chromatography

Comparison of Chromolith® Prep RP-18 endcapped 100–25 mm with particulate material – separation of Oxime-derivates

The comparison of Chromolith® Prep RP-18 endcapped with a particulate Purospher® RP-18 endcapped-column (250–50 mm) shows that both separations have a similar resolution under the same chromatographic conditions, however Chromolith® Prep RP-18 endcapped has a better selectivity than Purospher® RP-18 endcapped as exhibited by the resolution of the additional isomer peak at 7 minutes.

Packing stand NW 50 (250–50) filled with Purospher® RP-18 endcapped, 10 µm

Column	Packing stand NW 50 (250–50) filled with Purospher® RP-18 endcapped, 10 µm
Mobile phase	A: Water + 0.05 % TFA B: Acetonitrile + 0.05 % TFA
Gradient	linear in 30 min up to 100 % B
Flow rate	100 mL/min
Detection	UV 210 nm
Sample	125 mg Oxime-derivates in 500 µL Acetonitrile

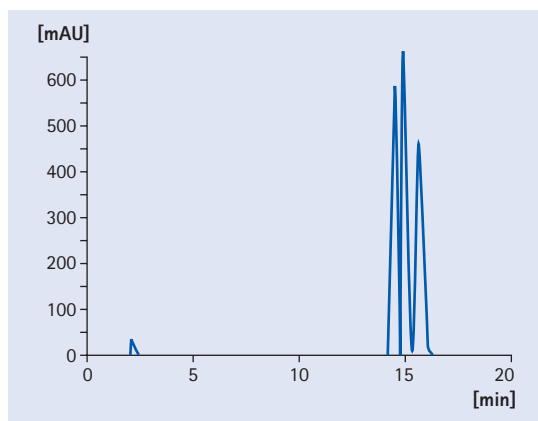

Chromolith® Prep RP-18 endcapped 100–25 mm

Column	Chromolith® Prep RP-18 endcapped 100–25 mm
Mobile phase	A: Water + 0.05 % TFA B: Acetonitrile + 0.05 % TFA
Gradient	linear in 11 min up to 100 % B
Flow rate	100 mL/min
Detection	UV 210 nm
Sample	125 mg Oxime-derivates in 500 µL Acetonitrile

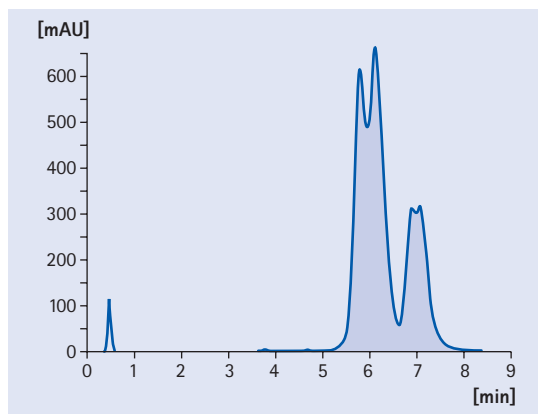

Separation of Hirudin (filtrate of crude extract)

Without any sample preparation the crude sample was injected directly onto the Chromolith® Prep RP-18 endcapped. The separation took only 5 minutes. It was possible to isolate the desired product from the impurities.

Chromolith® Prep RP-18 endcapped 100–25 mm

Column	Chromolith® Prep RP-18 endcapped 100–25 mm		
Mobile phase	A: Water + 0.1 % Formic acid B: Acetonitrile 100 %		
Gradient	Time [min]	% A	% B
	0	90	10
	10	70	30
	10.1	90	10
Flow rate	60 mL/min		
Detection	UV 254 nm		
Sample	23 mg Hirudin (filtrate of crude extract) in 5 mL solution injected		

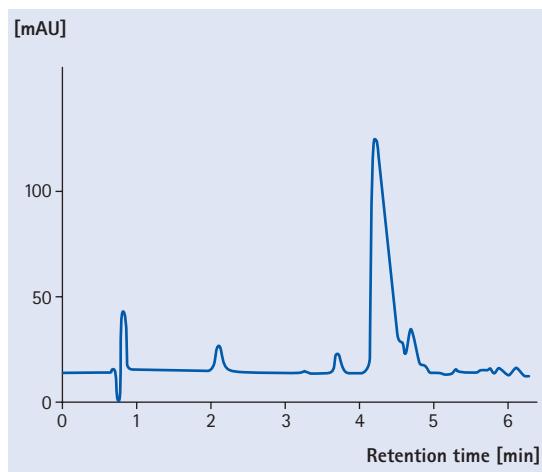

Separation of Dihydropyridines (Nifedipine, Nimodipine and Nisoldipine)

With monolithic silica rod technology it is possible to speed up your separation significantly!

Chromolith® Prep RP-18 endcapped shows a significant reduction of back-pressure.

Chromolith® Prep RP-18 endcapped 100–25 mm

Column	Chromolith® Prep RP-18 endcapped 100–25 mm		
Mobile phase	A: Water B: Acetonitrile		
Gradient	Time [min]	% A	% B
	0	80	20
	8	20	80
	8.1	80	20
Flow rate	100 mL/min		
Detection	UV 224 nm		
Sample	90 mg mixture of Nifedipine, Nimodipine and Nisoldipine		

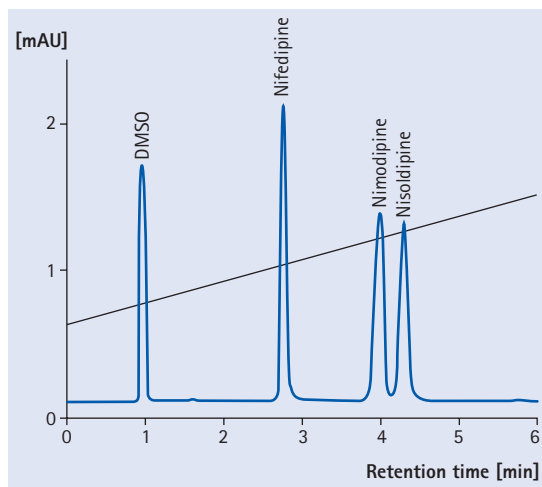

Purospher®

The all-round high performance solution for complex HPLC separations

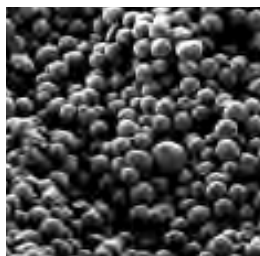

High-purity HPLC columns

The key component for modern RP-HPLC sorbents is a high purity silica as starting material. Purospher® HPLC columns are based on high purity, metal-free silica for outstanding separations with excellent peak symmetry. The base silica for Purospher® high purity HPLC columns is made from tetraalkoxysilane in a sol-gel process. Due to the absence of metals in the silica matrix and combined with an optimized surface coating and shielding process, Purospher® columns provide tailing-free separations of acidic, basic, and chelating compounds. This is of particular advantage for any kind of method development in Research and Development (R&D) and Quality Control (QC) laboratories.

▶ **Purospher® STAR RP-18 endcapped**
The versatility you need!
page 269

▶ **Purospher® STAR RP-8 endcapped** Ideal for less hydrophobic compounds
page 283

▶ **Purospher® STAR Phenyl**
Enhanced selectivity for aromatic compounds
page 286

▶ **Purospher® STAR Si (Silica) and NH₂ (Amino-phase)**
page 289

▶ **Purospher® RP-18 endcapped** Excellent peak symmetry with either basic or strongly acidic compounds
page 302

▶ **Purospher® RP-18**
Polar endcapped column material
page 304

▶ **Customized packings**
Always the right column
page 366

Accessories for particulate HPLC columns:

▶ **manu-CART® cartridge holder** for LiChroCART® cartridges
page 370

▶ **LiChroCART® cartridge**
Different lengths, different internal diameter
page 373

Purospher® HPLC columns benefits

- Enhanced performance and excellent peak symmetry due to high purity silica gel
- Outstanding batch-to-batch reproducibility for reliable analyses
- Balanced chromatographic properties (Tanaka Hexagon)
- Excellent separation efficiency for reliable results
- Extended column lifetime for higher laboratory efficiency

The Purospher® product family comprises different Purospher® HPLC packing materials

Purospher® RP-18 is polar Amino endcapped and suitable for separations of strong basic or chelating compounds (no acidic compounds) and separations of hydrophilic compounds with a high percentage of water in the mobile phase.

Purospher® RP-18 endcapped is suitable for separations of complex samples with simple eluents.

Purospher® RP-18 HC is not endcapped with very good suitability for separation of polar, non-basic compounds e.g. explosives.

Purospher® STAR RP-18 endcapped allows the tailing-free separation of neutral, acidic, basic or chelating compounds. The excellent stability up to pH 10.5 enables the separation of strong basic compounds with alkaline eluents. Purospher® STAR RP-18 endcapped is available in different particle sizes of 2 µm, 3 µm and 5 µm and as special UHPLC columns.

Purospher® STAR RP-8 endcapped for separation of less hydrophobic compounds or separation of position isomeric compounds.

Purospher® STAR Phenyl HPLC columns are the best alternative for the separation of aromatic compounds, and compounds containing aromatic groups.

Purospher® STAR NH₂ and Si for normal phase chromatography (Si) and separation of carbohydrates (NH₂).

Specifications of Purospher® high-purity HPLC columns

	Particle size [µm]	Pore size [Å]	Pore vol. [mL/g]	Spec. surface area [m ² /g]	% C load	Endcapping	pH stability	USP classification	Analytes
Purospher® STAR RP-18 endcapped	2, 3 or 5	120	1.1	330	17	hydrophobic	1.5 – 10.5	L1	neutral, acidic, basic or chelating compounds, high pH stability
Purospher® STAR RP-8 endcapped	2, 3 or 5	120	1.1	330	11.2	hydrophobic	1.5 – 10.5	L7	less hydrophobic compounds, position isomers
Purospher® Phenyl	2, 3 or 5	120	1.1	330	12.5	hydrophobic	1.5 – 10.5	L11	aromatic compounds
Purospher® STAR NH ₂	5	120	1.1	330	3.5	no endcapping	2 – 7.5	L8	carbohydrates
Purospher® STAR Si	5	120	1.1	330	–	–	2 – 7.5	L3	normal phase chromatography
Purospher® RP-18 endcapped	5	120	1.0	350	18.0	hydrophobic	2 – 8	L1	acids, basic or chelating compounds
Purospher® RP-18	5	90	0.95	500	18.5	amino endcapping	2 – 7.5	L1	strong bases or chelating compounds
Purospher® RP-18 HC	5	90	1.0	>470	18.0	no endcapping	2 – 7.5	L1	explosives

High purity silica gel

The prerequisite for a modern RP-sorbent is a highly purified silica as a starting material. Purospher® has a total heavy-metal content of 5 ppm. Thus no chelate complexes can be formed, as the symmetrical elution of 2,2' bipyridine shows – a very sensitive metal-complexing agent.

Chromatographic conditions

Mobile phase	Heptane/Dioxane (90/10, V/V)
Flow rate	1 mL/min
Detection	UV 254 nm
Temperature	30°C

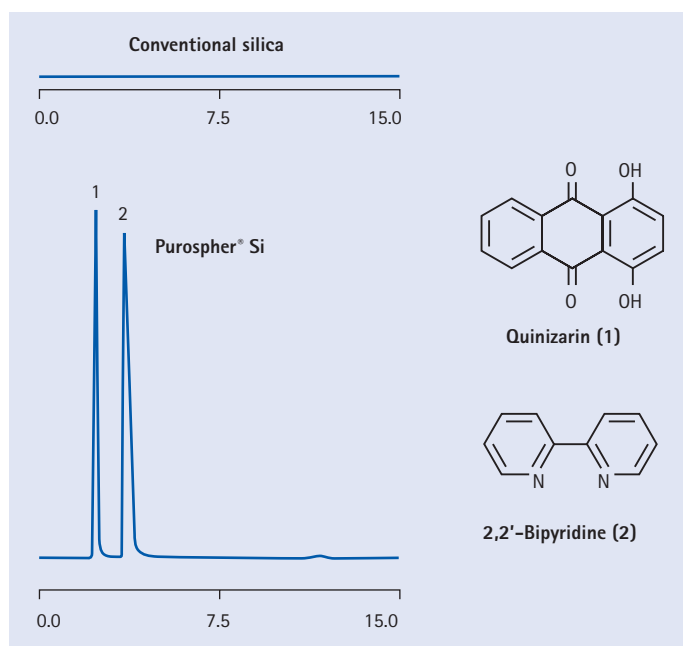

Characterization of Purospher® HPLC columns

Although it is very important to control the physical and chemical properties of stationary phases, a consistently high level of reproducibility can only be ensured by a comprehensive chromatographic characterization. **With respect to consistent selectivity we apply different approaches of leading scientists in HPLC.**

1. According to a proposal of Prof. Tanaka* Purospher® HPLC sorbents are characterized by a set of seven selected substances to describe retention capacity, hydrophobicity, steric selectivity and silanophilic properties.
2. The selectivity test of Prof. Engelhardt**, where the sorbent is controlled by injecting a mixture of 10 compounds.

Tanaka* test

The Tanaka* test illustrates the overall chromatographic properties of stationary phases. A set of seven selected substances is used to describe retention capacity, hydrophobicity, steric selectivity and silanophilic properties. To facilitate the illustration and to recognize the quality of a sorbent at one glance, the values of these parameters are outlined on the six axes of a hexagon. The more symmetrical the hexagon appears and the larger its area, the more balanced the stationary phase is in the sum of its chromatographic properties.

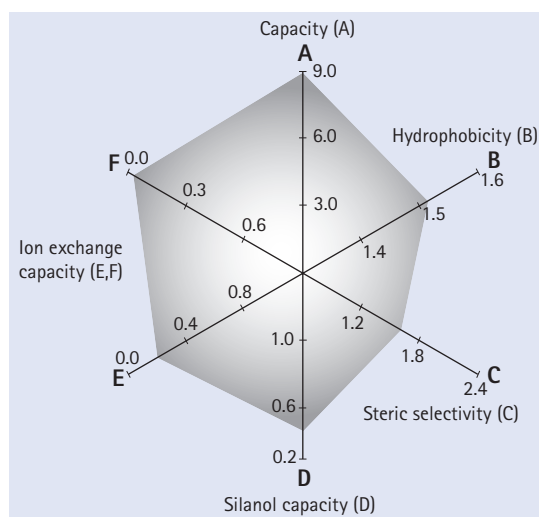

*Prof. Tanaka, Kyoto Institute of Technology, *J. Chrom. Sci.* 27, 725, 1989 | **Prof. Engelhardt, Universität des Saarlandes, Saarbrücken, *Chromatographia* 29, 59, 1990

Parameter for the characterization of Purospher® HPLC sorbents

Parameters	Property of the stationary phase	Factors in preparation of the stationary phase
(A) Retention capacity	k' (Pentylbenzene) / 80 % Methanol	amount of alkyl chains silica surface coverage
(B) Hydrophobicity	k' (Pentylbenzene) / k' (Butylbenzene) / 80 % Methanol	hydrophobic capacity surface coverage
(C) Steric selectivity	k' (Triphenylene) / k' (o-Terphenyl) / 80 % Methanol	steric selectivity silane functionality surface coverage
(D) Silanol capacity	k' (Caffeine) / k' (Phenol) / 30 % Methanol	silanol capacity residual silanols endcapping surface coverage
(E) Ion exchange capacity	k' (Benzylamine) / k' (Phenol) / 30 % Methanol / 70 % Phosphate buffer pH 7.6	ion exchange capacity at pH 7 residual silanols active sites pH 7
(F) Ion exchange capacity	k' (Benzylamine) / k' (Phenol) / 30 % Methanol / 70 % Phosphate buffer pH 2.7	ion exchange capacity at pH 3 active sites pH 3 treatment of basic silica

Tanaka test 1–4

Tanaka 1

[Retention capacity/Hydrophobicity/Steric Selectivity]

Column	Purospher® STAR RP-18 endcapped, 5 µm LiChroCART® 150-4.6
Mobile phase	Methanol / Water 80:20
Flow rate	1.0 mL/min
Detection	UV 254 nm
Temperature	30°C
Injection volume	10 µL
Sample	1. Uracil 2. Butylbenzene 3. o-Terphenyl 4. Pentylbenzene 5. Triphenylene

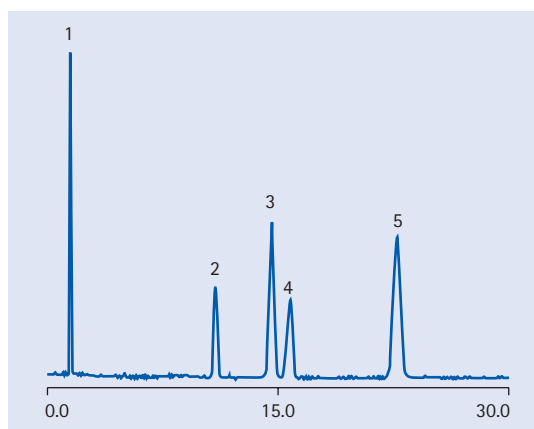

Tanaka 2 [Silanophilic properties]

Column	Purospher® STAR RP-18 e, 5 µm LiChroCART® 125-4	
Mobile phase	A: Methanol / Water 30:70 (v/v)	B: Acetonitrile / Water 30:70 (v/v)
Flow rate	1.0 mL/min	
Detection	UV 254 nm	
Sample	A: 1. Uracil 2. Caffeine 3. Phenol	B: 1. Pyridine 2. Phenol

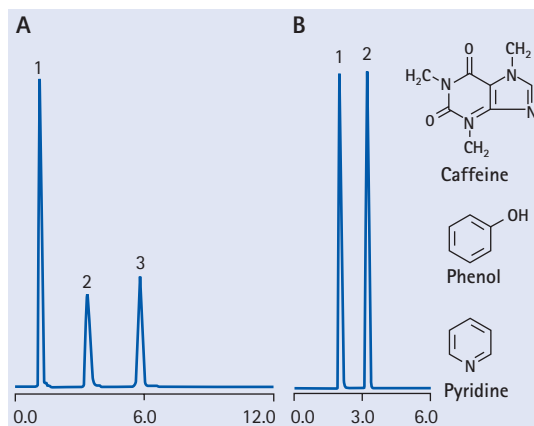

Tanaka 3+4 [Ion exchange properties]

Column	Purospher® STAR RP-18 endcapped, 5 µm LiChroCART® 125-4	
Mobile phase	Methanol (0.02 M) / Phosphoric acid 30:70 (v/v)	
Flow rate	0.6 mL/min	
Detection	UV 254 nm	
Sample	1. Uracil 2. Benzylamine 3. Phenol	

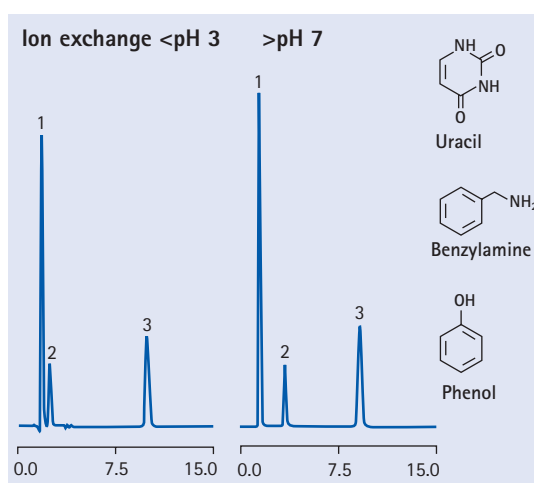

Engelhardt* test

This test, developed by Prof. Engelhardt, is suitable for describing the properties of a RP-phase. Toluene and ethylbenzene demonstrate the hydrophobic properties; neutral polar interactions can be investigated using phenol and ethyl benzoate. The important behavioural characteristic with respect to basic compounds is shown by the injection of 5 different amines. Aniline is eluted before phenol and with excellent peak shape. **The most important criteria is the co-elution of the isomers of ethyl aniline, that indicates a good suppression of the silanolic activity.**

* Prof. Engelhardt, Universität des Saarlandes, Saarbrücken, Chromatographia 29, 59, 1990

Purospher® RP-18

Purospher® RP-18 shows no co-elution of p-, m- and o-ethyl aniline and polar interactions due to the amino endcapping of this phase. The anilines are eluting with symmetric peaks, which shows its very good suitability for separation of strong bases.

Column	Purospher® RP-18 LiChroCART® 125-4	
Mobile phase	Methanol/Water 55/45 (v/v)	
Flow rate	1.0 mL/min	
Detection	UV 254 nm	
Temperature	ambient	
Sample	1. Thiourea	t_0
	2. Aniline	basic
	3. Phenol	acidic
	4. p-, m-, o-ethyl aniline	basic
	5. N,N-Dimethyl aniline	basic
	6. Ethyl benzoate	neutral
	7. Toluene	neutral
	8. Ethylbenzene	neutral

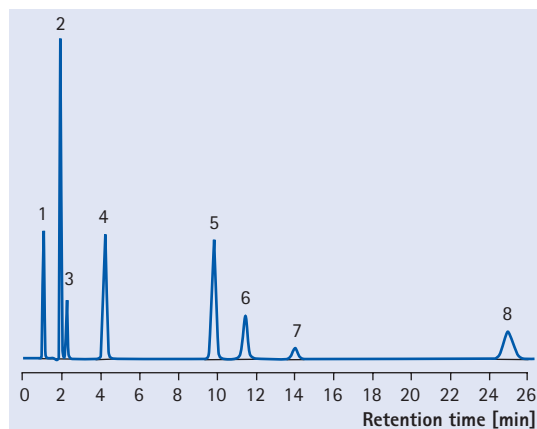

Purospher® RP-18 endcapped

Purospher® RP-18 endcapped shows perfect co-elution of p-, m- and o-ethyl aniline indicating no polar interactions. The anilines are eluting as symmetric peaks which shows the very good suitability for separation of strong bases. The retention time of ethyl benzene indicates the hydrophobic properties of the phase.

Column	Purospher® RP-18 endcapped LiChroCART® 125-4	
Mobile phase	Methanol/Water 55/45 (v/v)	
Flow rate	1.0 mL/min	
Detection	UV 254 nm	
Temperature	ambient	
Sample	1. Thiourea	t_0
	2. Aniline	basic
	3. Phenol	acidic
	4. p-, m-, o-ethyl aniline	basic
	5. N,N-Dimethyl aniline	basic
	6. Ethyl benzoate	neutral
	7. Toluene	neutral
	8. Ethylbenzene	neutral

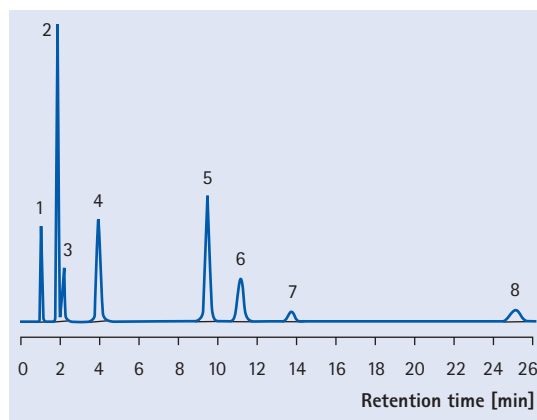

Purospher® STAR RP-18 endcapped

Purospher® STAR RP-18 endcapped shows perfect co-elution of p-, m- and o-ethyl aniline indicating no polar interactions. The anilines are eluting as symmetric peaks, which shows the very good suitability for separation of strong bases. Purospher® STAR RP-18 endcapped shows an analogue selectivity to Purospher® RP-18 endcapped.

Column	Purospher® STAR RP-18 endcapped LiChroCART® 125-4	
Mobile phase	Methanol/Water 55/45 (v/v)	
Flow rate	1.0 mL/min	
Detection	UV 254 nm	
Temperature	ambient	
Sample	1. Thiourea	t_0
	2. Aniline	basic
	3. Phenol	acidic
	4. p-, m-, o-ethyl aniline	basic
	5. N,N-Dimethyl aniline	basic
	6. Ethyl benzoate	neutral
	7. Toluene	neutral
	8. Ethylbenzene	neutral

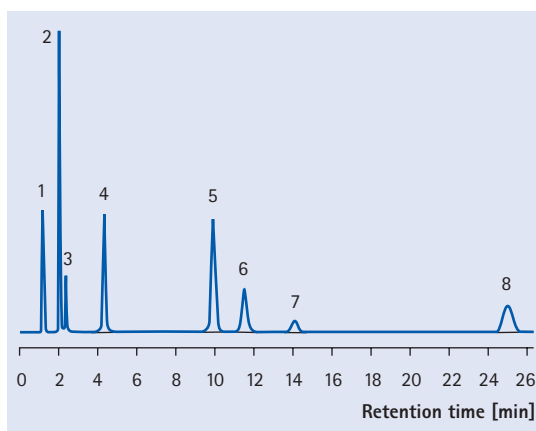
**Purospher® RP-18 HC**

Purospher® RP-18 HC shows very clear polar interactions, due to no endcapping. Aniline and Phenol are eluting in one peak. Bases are eluting late. Best suitability for separation of polar, non-basic molecules e.g. explosives.

Column	Purospher® RP-18 HC LiChroCART® 125-4	
Mobile phase	Methanol/Water 55/45 (v/v)	
Flow rate	1.0 mL/min	
Detection	UV 254 nm	
Temperature	ambient	
Sample	1. Thiourea	t_0
	2. Aniline	basic
	3. Phenol	acidic
	4. p-, m-, o-ethyl aniline	basic
	5. N,N-Dimethyl aniline	basic
	6. Ethyl benzoate	neutral
	7. Toluene	neutral
	8. Ethylbenzene	neutral

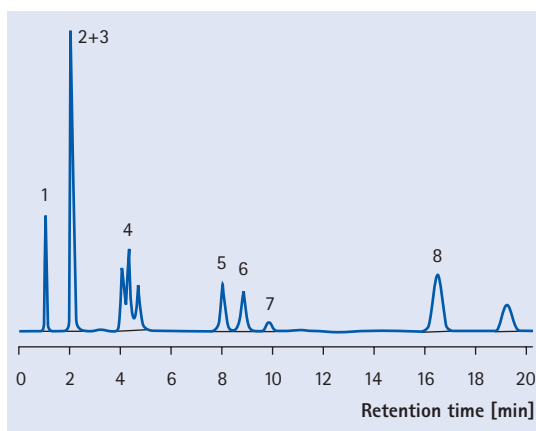

Purospher® STAR RP-8 endcapped

Purospher® STAR RP-8 endcapped shows no co-elution of p-, m- and o-ethyl aniline and polar interactions, because of the thin hydrophobic coverage with short C-chains. The anilines are eluting as symmetric peaks, which shows the very good suitability for separation of strong bases. Ethyl benzoate and toluene are eluting in one peak – this is typical for C-8 phases.

Column	Purospher® STAR RP-8 endcapped LiChroCART® 125-4	
Mobile phase	Methanol/Water 55/45 (v/v)	
Flow rate	1.0 mL/min	
Detection	UV 254 nm	
Temperature	ambient	
Sample	1. Thiourea	t ₀
	2. Aniline	basic
	3. Phenol	acidic
	4. p-, m-, o-ethyl aniline	basic
	5. N,N-Dimethyl aniline	basic
	6. Ethyl benzoate	neutral
	7. Toluene	neutral
	8. Ethylbenzene	neutral

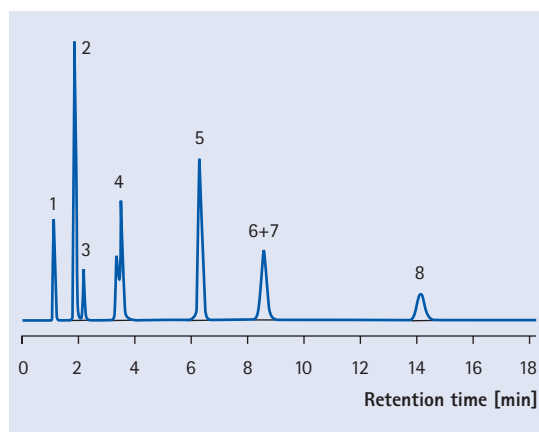

Chromatographic properties of Purospher® stationary phases

	Peak symmetry of complexing agents	Polar interactions	Steric selectivity	CH ₂ group selectivity	Silanol group activity	Hydrophobicity
Purospher® RP-18	+++	++	+++	+++	++	+
Purospher® RP-18 endcapped	+++	-	+++	+++	-	+++
Purospher® STAR RP-18 endcapped	+++	-	+++	+++	-	+++
Purospher® STAR RP-8 endcapped	+++	+	+	++	++	+
Purospher® RP-18 HC	+++	++	+++	+++	+	++

Purospher® STAR RP-18 endcapped

The versatility you need!

Purospher® STAR RP-18 endcapped HPLC columns are designed for universal use. Basic, neutral, and metal chelating compounds can easily be separated with simple mobile phases – naturally without peak tailing! Thanks to its outstanding performance and stability, Purospher® STAR RP-18 endcapped offers maximum flexibility in method development. Robust methods can be developed over the entire pH range from 1.5 to 10.5. The high pH-stability up to pH 10.5 allows the separation of strongly basic compounds with alkaline eluents. The combination of high purity silica, best all-round retention characteristics, outstanding pH stability up to pH 10.5, and suitability for up to 100 % aqueous mobile phases, make Purospher® STAR RP-18 endcapped an all-round top performance column, almost universal in its range of applications.



Experience the performance of Purospher® STAR RP-18 endcapped

- Highest silica purity (99.999 %) for excellent peak symmetry
- High separation efficiency
- Absolutely reproducible results from run-to-run and from batch-to-batch
- Best all-round retention characteristics
- Outstanding pH-stability from pH 1.5 – 10.5
- No phase collapse when using highly aqueous mobile phases
- Good suitability for LC-MS applications

Key performance benefits: Fast method development of complex samples across the pH range from 1.5 to 10.5 at different mobile phases and temperature conditions.

Specification of Purospher® STAR RP-18 endcapped

Sorbent characteristics	High purity silica with polymeric C18 modification and endcapping	
Metal content	Na, Ca, Mg, Al: 1 ppm; Fe: 3 ppm	
Particle shape	spherical	
Particle size	2 µm, 3 µm and 5 µm	
Pore size	12 nm (120 Å)	
Pore volume	1.1 mL/g	
Specific surface area	330 m ² /g	
Carbon load	17 % C	
Coverage of the surface	3 µmol/m ²	
Efficiency	5 µm	>90,000 N/m
	3 µm	>130,000 N/m
	2 µm	>180,000 N/m
pH range	pH 1.5 – 10.5	
Shipping eluent	Acetonitrile/Water	

► Purospher® STAR UHPLC columns for ultra fast HPLC Where speed meets performance **page 292**

► Purospher® STAR RP-8 endcapped Ideal for less hydrophobic compounds **page 283**

► Purospher® STAR Phenyl Enhanced selectivity for aromatic compounds **page 286**

► Purospher® STAR Si (Silica) and NH₂ (Amino-phase) **page 289**

► Purospher® RP-18 endcapped Excellent peak symmetry with either basic or strongly acidic compounds **page 302**

► Purospher® RP-18 Polar endcapped column material **page 304**

► Customized packings Always the right column **page 366**

Accessories for particulate HPLC columns:

► manu-CART® cartridge holder for LiChroCART® cartridges **page 370**

► LiChroCART® cartridge Different lengths, different internal diameter **page 373**

► Hibar® column **page 375**

Ordering information – Purospher® STAR RP-18 endcapped (3 µm), stainless steel cartridges LiChroCART®

Product	Ordering No.	Particle size	Dimension length	Dimension i.d.	Contents of one package
Purospher® STAR RP-18 endcapped, cartridge set (1 LiChroCART® 30-2 and 1 manu-CART® 30 mm)	1.50237.0001	3 µm	30 mm	2 mm	1 set
Purospher® STAR RP-18 endcapped	1.50238.0001	3 µm	30 mm	2 mm	3 pieces
Purospher® STAR RP-18 endcapped, cartridge set (1 LiChroCART® 55-2 and 1 manu-CART® 55 mm)	1.50240.0001	3 µm	55 mm	2 mm	1 set
Purospher® STAR RP-18 endcapped, cartridge set	1.50241.0001	3 µm	55 mm	2 mm	3 pieces
Purospher® STAR RP-18 endcapped, custom packed	1.50190.7184	3 µm	125 mm	2 mm	1 piece
Purospher® STAR RP-18 endcapped, custom packed	1.50175.7184	3 µm	125 mm	3 mm	1 piece
Purospher® STAR RP-18 endcapped, custom packed	1.50177.7184	3 µm	250 mm	3 mm	1 piece
Purospher® STAR RP-18 endcapped, cartridge set (1 LiChroCART® 30-4 and 1 manu-CART® 30 mm)	1.50239.0001	3 µm	30 mm	4 mm	1 set
Purospher® STAR RP-18 endcapped	1.50225.0001	3 µm	30 mm	4 mm	3 pieces
Purospher® STAR RP-18 endcapped, cartridge set (1 LiChroCART® 55-4 and 1 manu-CART® 55 mm)	1.50242.0001	3 µm	55 mm	4 mm	1 set
Purospher® STAR RP-18 endcapped	1.50231.0001	3 µm	55 mm	4 mm	3 pieces
Purospher® STAR RP-18 endcapped	1.51460.0001	3 µm	75 mm	4 mm	1 piece
Purospher® STAR RP-18 endcapped, custom packed	1.50174.7184	3 µm	250 mm	4 mm	1 piece
Purospher® STAR RP-18 endcapped, custom packed	1.51448.7184	3 µm	100 mm	4.6 mm	1 piece

The LiChroCART® columns (75, 125, 150 and 250 mm length) in the list above (2, 3, 4 and 4.6 mm i.d.) require part number 1.51486.0001 manu-CART® cartridge column holder, which can be used to hold one cartridge column with or without a 4–4 mm guard column. LiChroCART® columns 250–10 mm require part number 1.51419.0001 manu-CART® 10. The short LiChroCART® columns (30 and 55 mm length) can be ordered as a set including the corresponding cartridge holder and one cartridge, or as a pack of 3 cartridges without cartridge holder. Additional dimensions available as customized packings see page 366. The separate part numbers for the cartridge are as follows: 1.50227.0001 LiChroCART® cartridge holder for 30 mm cartridge and 1.50226.0001 LiChroCART® cartridge holder for 55 mm cartridge.

Ordering information – Purospher® STAR RP-18 endcapped (5 µm), stainless steel cartridges LiChroCART®

Product	Ordering No.	Particle size	Dimension length	Dimension i.d.	Contents of one package
Purospher® STAR RP-18 endcapped, custom packed	1.50234.7185	5 µm	55 mm	2 mm	1 piece
Purospher® STAR RP-18 endcapped	1.50623.0001	5 µm	100 mm	2 mm	1 piece
Purospher® STAR RP-18 endcapped	1.50255.0001	5 µm	125 mm	2 mm	1 piece
Purospher® STAR RP-18 endcapped	1.50624.0001	5 µm	150 mm	2 mm	1 piece
Purospher® STAR RP-18 endcapped	1.50256.0001	5 µm	250 mm	2 mm	1 piece
Purospher® STAR RP-18 endcapped	1.50625.0001	5 µm	100 mm	3 mm	1 piece
Purospher® STAR RP-18 endcapped	1.50253.0001	5 µm	125 mm	3 mm	1 piece
Purospher® STAR RP-18 endcapped	1.50626.0001	5 µm	150 mm	3 mm	1 piece
Purospher® STAR RP-18 endcapped	1.50254.0001	5 µm	250 mm	3 mm	1 piece
Purospher® STAR RP-18 endcapped	1.50250.0001	5 µm	4 mm	4 mm	10 pieces
Purospher® STAR RP-18 endcapped, custom packed	1.50172.7185	5 µm	25 mm	4 mm	1 piece
Purospher® STAR RP-18 endcapped, custom packed	1.50302.7185	5 µm	30 mm	4 mm	1 piece
Purospher® STAR RP-18 endcapped, custom packed	1.50228.7185	5 µm	55 mm	4 mm	1 piece
Purospher® STAR RP-18 endcapped, custom packed	1.50171.7185	5 µm	75 mm	4 mm	1 piece
Purospher® STAR RP-18 endcapped	1.50251.0001	5 µm	125 mm	4 mm	1 piece
Purospher® STAR RP-18 endcapped	1.50252.0001	5 µm	250 mm	4 mm	1 piece
Purospher® STAR RP-18 endcapped	1.50627.0001	5 µm	100 mm	4.6 mm	1 piece
Purospher® STAR RP-18 endcapped	1.50358.0001	5 µm	150 mm	4.6 mm	1 piece
Purospher® STAR RP-18 endcapped	1.50359.0001	5 µm	250 mm	4.6 mm	1 piece
Purospher® STAR RP-18 endcapped	1.50257.0001	5 µm	250 mm	10 mm	1 piece

The LiChroCART® columns (75, 100, 125, 150 and 250 mm length) in the list above (2, 3, 4 and 4.6 mm i.d.) require part number 1.51486.0001 manu-CART® cartridge column holder, which can be used to hold one cartridge column with or without a 4–4 mm guard column. LiChroCART® columns 250–10 mm require part number 1.51419.0001 manu-CART® 10. The short LiChroCART® columns (30 and 55 mm length) can be ordered as a set including the corresponding cartridge holder and one cartridge, or as a pack of 3 cartridges without cartridge holder. Additional dimensions available as customized packings see page 366. The separate part numbers for the cartridge are as follows: 1.50227.0001 LiChroCART® cartridge holder for 30 mm cartridge and 1.50226.0001 LiChroCART® cartridge holder for 55 mm cartridge.



Purospher® STAR RP-18 endcapped column

Ordering information – Purospher® STAR RP-18 endcapped (3 µm), stainless steel Hibar® RT columns

Product	Ordering No.	Particle size	Dimension length	Dimension i.d.	Contents of one package
Purospher® STAR RP-18 endcapped	1.50393.0001	3 µm	50 mm	3 mm	1 piece
Purospher® STAR RP-18 endcapped	1.50398.0001	3 µm	100 mm	3 mm	1 piece
Purospher® STAR RP-18 endcapped	1.50413.0001	3 µm	125 mm	3 mm	1 piece
Purospher® STAR RP-18 endcapped	1.50414.0001	3 µm	150 mm	3 mm	1 piece
Purospher® STAR RP-18 endcapped	1.50427.0001	3 µm	250 mm	3 mm	1 piece
Purospher® STAR RP-18 endcapped	1.50428.0001	3 µm	50 mm	4 mm	1 piece
Purospher® STAR RP-18 endcapped	1.50431.0001	3 µm	125 mm	4 mm	1 piece
Purospher® STAR RP-18 endcapped	1.50468.0001	3 µm	250 mm	4 mm	1 piece
Purospher® STAR RP-18 endcapped	1.50469.0001	3 µm	100 mm	4.6 mm	1 piece
Purospher® STAR RP-18 endcapped, custom packed	1.50012.7184	3 µm	125 mm	4.6 mm	1 piece
Purospher® STAR RP-18 endcapped	1.50470.0001	3 µm	150 mm	4.6 mm	1 piece
Purospher® STAR RP-18 endcapped	1.50471.0001	3 µm	250 mm	4.6 mm	1 piece

The Hibar® RT columns are complete with endfittings. When using a guard column with a Hibar® RT column, we recommend part number 1.51487.0001 guard column cartridge holder for 4–4 mm guard column cartridges LiChroCART®. Additional dimensions available as customized packings see page 366.

Ordering information – Purospher® STAR RP-18 endcapped (5 µm), stainless steel Hibar® RT columns

Product	Ordering No.	Particle size	Dimension length	Dimension i.d.	Contents of one package
Purospher® STAR RP-18 endcapped	1.50593.0001	5 µm	50 mm	2 mm	1 piece
Purospher® STAR RP-18 endcapped	1.50595.0001	5 µm	100 mm	2 mm	1 piece
Purospher® STAR RP-18 endcapped	1.50596.0001	5 µm	125 mm	2 mm	1 piece
Purospher® STAR RP-18 endcapped	1.50597.0001	5 µm	150 mm	2 mm	1 piece
Purospher® STAR RP-18 endcapped	1.50598.0001	5 µm	250 mm	2 mm	1 piece
Purospher® STAR RP-18 endcapped	1.50607.0001	5 µm	50 mm	3 mm	1 piece
Purospher® STAR RP-18 endcapped	1.50612.0001	5 µm	100 mm	3 mm	1 piece
Purospher® STAR RP-18 endcapped	1.50615.0001	5 µm	125 mm	3 mm	1 piece
Purospher® STAR RP-18 endcapped	1.50617.0001	5 µm	150 mm	3 mm	1 piece
Purospher® STAR RP-18 endcapped	1.50620.0001	5 µm	250 mm	3 mm	1 piece
Purospher® STAR RP-18 endcapped	1.50621.0001	5 µm	50 mm	4 mm	1 piece
Purospher® STAR RP-18 endcapped	1.50036.0001	5 µm	125 mm	4 mm	1 piece
Purospher® STAR RP-18 endcapped	1.50037.0001	5 µm	250 mm	4 mm	1 piece
Purospher® STAR RP-18 endcapped	1.50622.0001	5 µm	100 mm	4.6 mm	1 piece
Purospher® STAR RP-18 endcapped	1.51455.0001	5 µm	150 mm	4.6 mm	1 piece
Purospher® STAR RP-18 endcapped	1.51456.0001	5 µm	250 mm	4.6 mm	1 piece

The Hibar® RT columns are complete with endfittings. When using a guard column with a Hibar® RT column, we recommend part number 1.51487.0001 guard column cartridge holder for 4–4 mm guard column cartridges LiChroCART®. Additional dimensions available as customized packings see page 366.

Ordering information – Validation kits, Purospher® STAR RP-18 endcapped, stainless steel cartridges LiChroCART®

Product	Ordering No.	Particle size	Dimension length	Dimension i.d.	Contents of one package
Purospher® STAR RP-18 endcapped, validation kit (3 columns of 3 different sorbent batches)	1.50251.1003	5 µm	125 mm	4 mm	1 set
Purospher® STAR RP-18 endcapped, validation kit (3 columns of 3 different sorbent batches)	1.50252.1003	5 µm	250 mm	4 mm	1 set
Purospher® STAR RP-18 endcapped, validation kit (3 columns of 3 different sorbent batches)	1.50358.1003	5 µm	125 mm	4.6 mm	1 set
Purospher® STAR RP-18 endcapped, validation kit (3 columns of 3 different sorbent batches)	1.50359.1003	5 µm	250 mm	4.6 mm	1 set

The LiChroCART® columns (125 and 250 mm length) in the list above (4 and 4.6 mm i.d.) require part number 1.51486.0001 manu-CART® cartridge column holder, which can be used to hold one cartridge column with or without a 4-4 mm guard column. Additional dimensions available as customized packings see page 366.

Ordering information – Validation kits, Purospher® STAR RP-18 endcapped, stainless steel Hibar® RT columns

Product	Ordering No.	Particle size	Dimension length	Dimension i.d.	Contents of one package
Purospher® STAR RP-18 endcapped, validation kit (3 columns of 3 different sorbent batches)	1.50617.1003	5 µm	150 mm	3 mm	1 set
Purospher® STAR RP-18 endcapped, validation kit (3 columns of 3 different sorbent batches)	1.50036.1003	5 µm	125 mm	4 mm	1 set
Purospher® STAR RP-18 endcapped, validation kit (3 columns of 3 different sorbent batches)	1.50037.1003	5 µm	250 mm	4 mm	1 set
Purospher® STAR RP-18 endcapped, validation kit (3 columns of 3 different sorbent batches)	1.51455.1003	5 µm	150 mm	4.6 mm	1 set
Purospher® STAR RP-18 endcapped, validation kit (3 columns of 3 different sorbent batches)	1.51456.1003	5 µm	250 mm	4.6 mm	1 set

The Hibar® RT columns are complete with endfittings. When using a guard column with a Hibar® RT column, we recommend part number 1.51487.0001 guard column cartridge holder for 4-4 mm guard column cartridges LiChroCART®. Additional dimensions available as customized packings see page 366.

Purospher® STAR RP-18 endcapped

Characterization of Purospher® STAR RP-18 endcapped

Purospher® STAR RP-18 endcapped HPLC columns are designed for universal use. It doesn't matter if your samples are basic, neutral, metal chelating or indeed any other format. You can be sure that Purospher® STAR can do it, naturally without peak tailing! This is proved by many users, who appreciate the excellent properties of Purospher® STAR RP-18 endcapped HPLC columns.

Surface modification of Purospher® STAR RP-18 endcapped

The polymeric surface modification of Purospher® RP-18 endcapped provides a nearly perfect coverage of the surface. This prevents polar interactions.

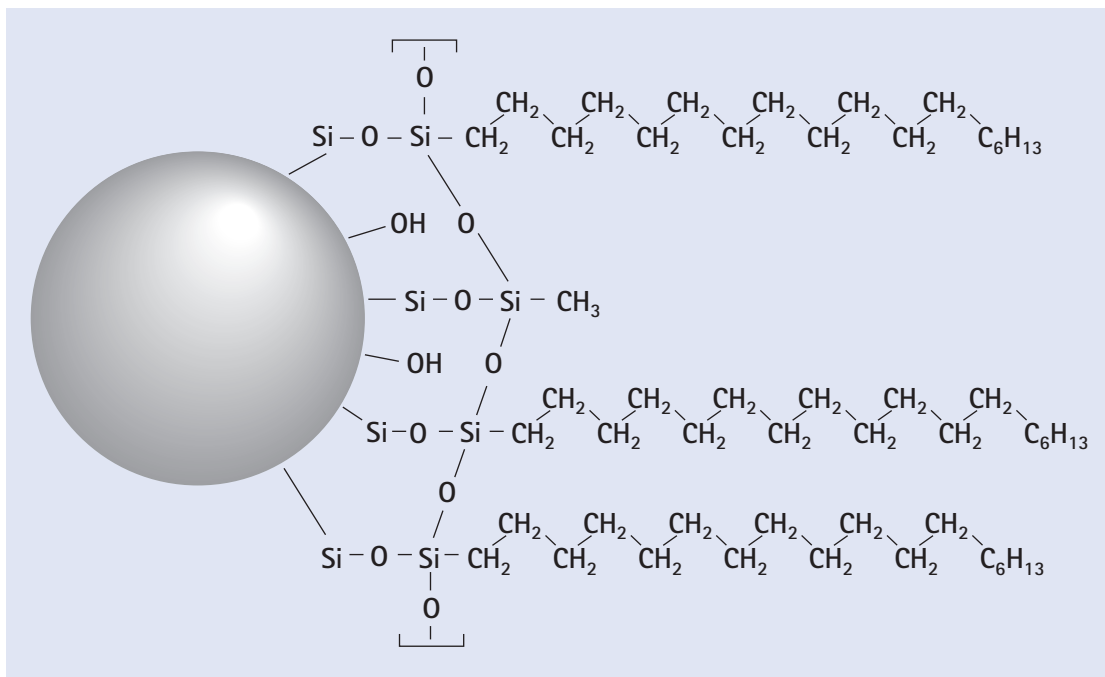

*Purospher® STAR RP-18
endcapped column*

Highest purity

Due to the absence of metals in the silica matrix, in combination with a complete coverage of the silica surface, this stationary phase enables tailing-free chromatography of acidic, basic and chelating compounds. There are differences in quality of so-called "high purity" HPLC column materials. The peak shape of the complexing agent Quinizarin is the best indicator for purity of silica.

The column comparison shown in the figures below demonstrates Purospher® STAR RP-18 endcapped with the best peak-symmetry for Quinizarin and the silica of highest purity.

Mobile phase	Methanol/Buffer pH 7.0 80/20 (5 mmol KH ₂ PO ₄ and 5 mmol K ₂ HPO ₄)
Flow rate	1.0 mL/min
Detection	UV 254 nm
Temperature	22°C
Sample	1. Uracil 2. Toluene 3. Ethylbenzene 4. Quinizarin 5. Amitriptyline

Purospher® STAR RP-18 endcapped

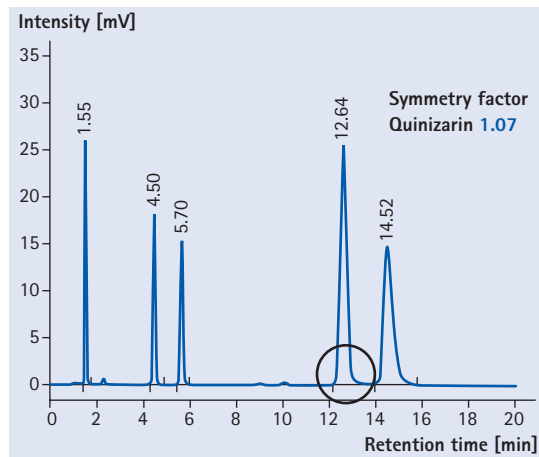

Column I

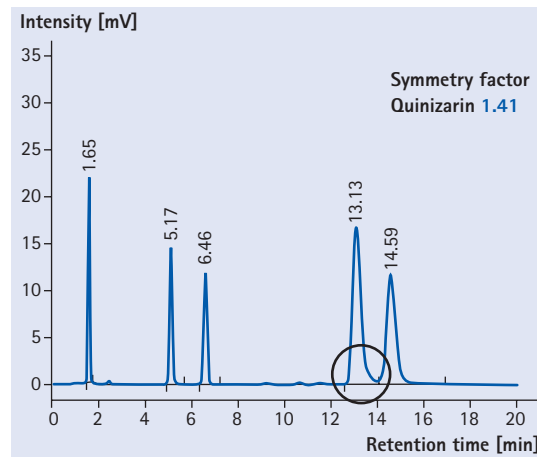

Column X

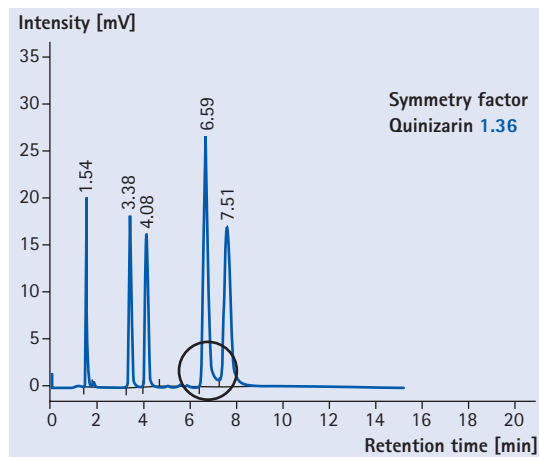

Column L

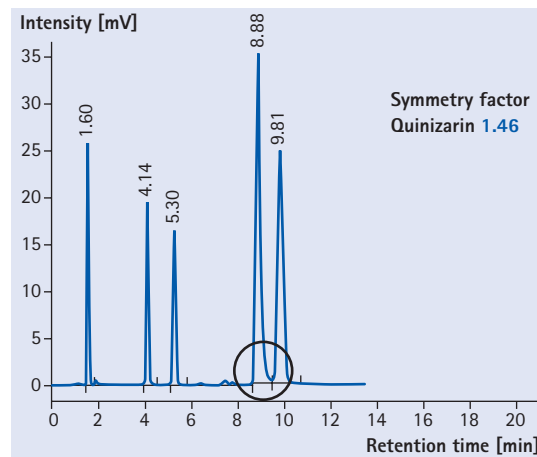

Outstanding pH-stability

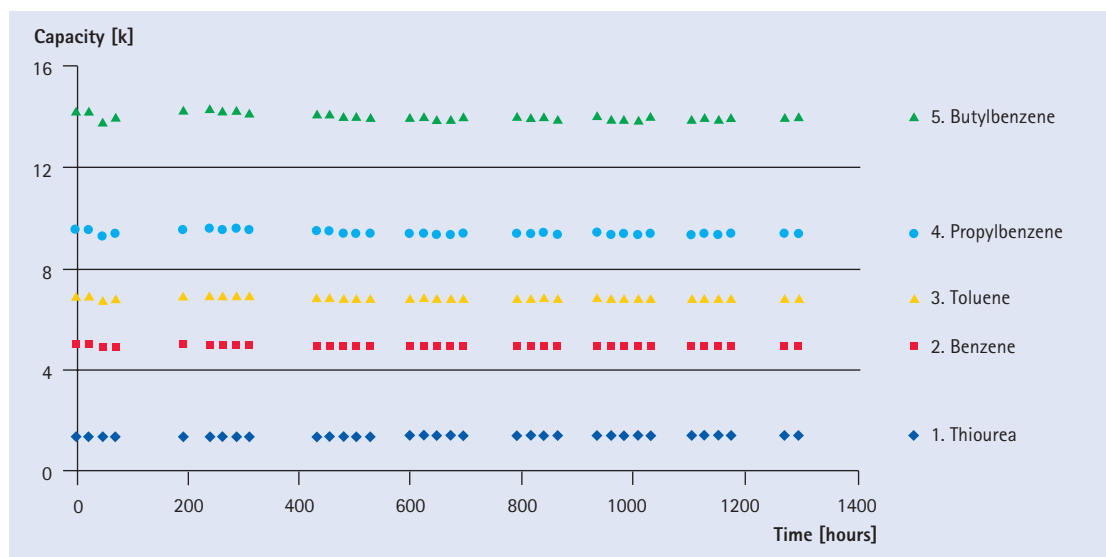

Stability test at pH 10.5

Column	Purospher® STAR RP-18 endcapped, 5 µm LiChroCART® 150-4.6
Mobile phase	Acetonitrile/Water (0.1 % NH ₃ ; [25 %]; 60 : 40)
Flow rate	1.0 mL/min
Detection	UV 254 nm
Temperature	ambient
Injection volume	10 µL
Sample	1. Thiourea 2. Benzene 3. Toluene 4. Propylbenzene 5. Butylbenzene

A column that is robust, stable in a range of eluent conditions has an extended column life and provides the required pH stability for 99 % of common analysis. Purospher® STAR RP-18 endcapped has outstanding pH stability. Various studies have shown that Purospher® STAR RP-18 endcapped remains stable and reproducible in a pH range of **1.5 to 10.5**. This ensures a simple choice in most applications.

Excellently balanced

The Tanaka* test (please see page 264) is established world-wide as the best method of comparing the selectivity and performance of HPLC columns. This test summarizes and visualizes all the most important parameters required when choosing the right HPLC column and allows easy comparisons to be made.

A set of seven selected substances is used to describe capacity, hydrophobicity, steric selectivity and silanophilic properties. To facilitate the illustration and to recognize the quality of a sorbent at one glance, the values of these parameters are outlined on the six axes of a hexagon. **The more symmetrical the hexagon appears and the larger its area, the more balanced the stationary phase is in the sum of its chromatographic properties.**

*Prof. Tanaka, Kyoto Institute of Technology, *J. Chrom. Sci.* 27, 725, 1989

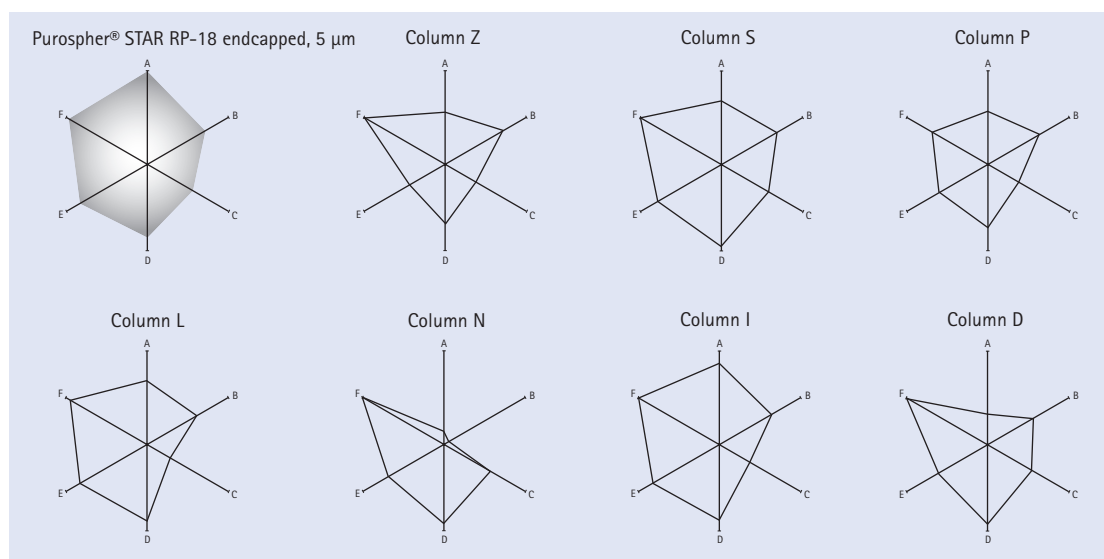

Tanaka test results for Purospher® STAR RP-18e

Column	Purospher® STAR RP-18 endcapped, 5 µm		
Chromatographic properties			
A	Retention capacity	K Pentylbenzene	9.59
B	Hydrophobicity	α Pentyl-/Butylbenzene	1.51
C	Steric selectivity	α Triphenylene/o-Terphenyl	1.63
D	Silanol capacity	α Caffeine/Phenol	0.44
E	Ion exchange capacity	α Benzylamine/Phenol pH 7.6	0.23
F	Ion exchange capacity	α Benzylamine/Phenol pH 2.7	0.02

Use with 100 % aqueous phase

Standard reversed phase columns, particularly RP-18 columns, often suffer from phase collapse when used in combination with highly aqueous mobile phases. The outstanding performance of Purospher® STAR RP-18 endcapped enables the use with 100 % aqueous mobile phases in combination with selectivity of a classical RP-18 stationary phase. Chromatogram **A** shows the first separation with 1 % acetic acid as mobile phase. Chromatogram **B** shows the same separation after 3 hours.

Purospher® STAR RP-18 endcapped

Only Purospher® STAR RP-18 endcapped shows the same separation in Chromatogram B. In contrast to competitive columns Purospher® STAR RP-18 endcapped is suitable as aqua phase.

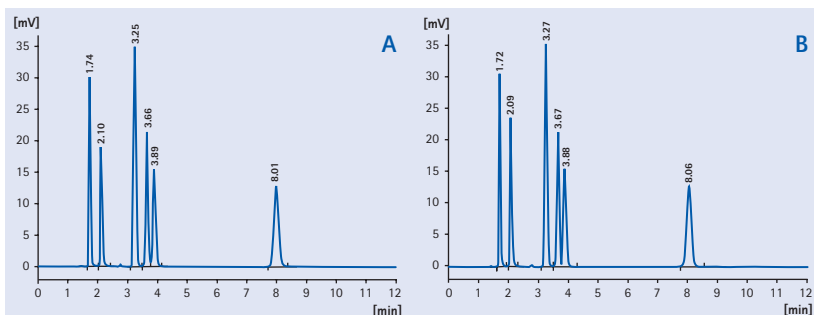

Column I

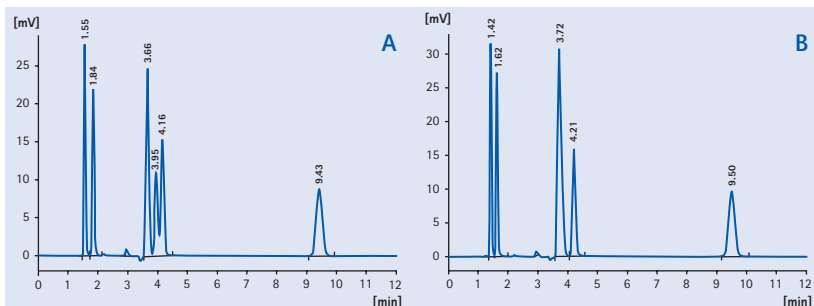

Column X

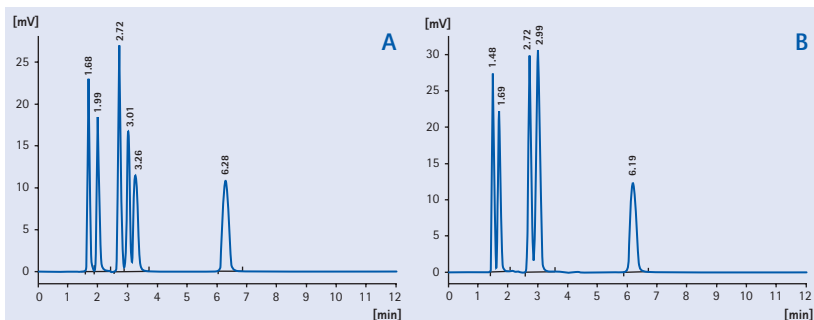

Column L

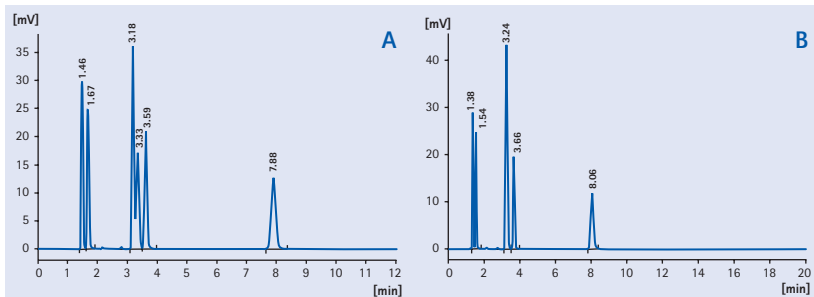

Stability test for efficiency and retention time over 15,000 column volumes (115 h)

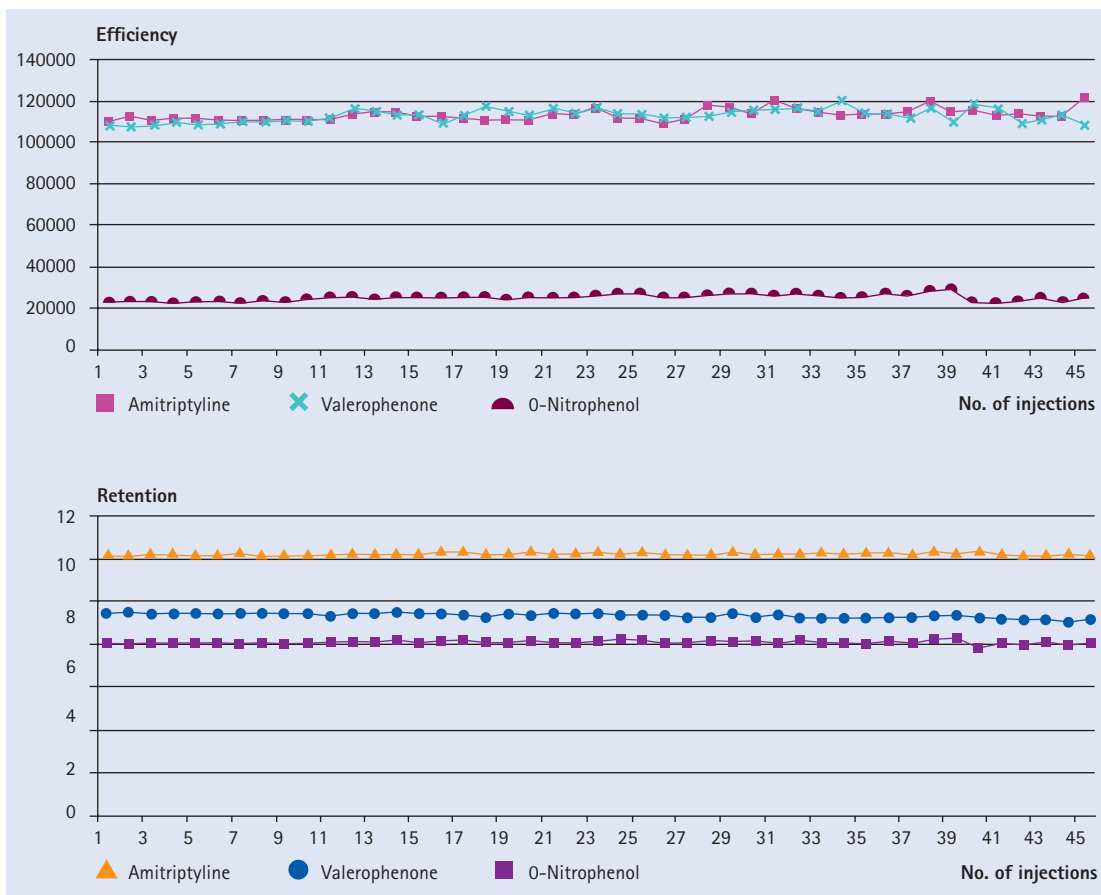

Stability test

Column	Purospher® STAR RP-18 endcapped, 3 µm LiChroCART® 55-4
Mobile phase	0.1 v/v% H ₃ PO ₄ in Water
Flow rate	1.5 mL/min
Temperature	60°C
Sample	Amitriptyline Valerophenone o-Nitrophenol

The combination of extremely high purity silica, best all-round retention characteristics, outstanding pH stability up to pH 10.5 and suitability for use with 100 % aqueous mobile phases makes Purospher® STAR RP-18 endcapped an all-round top performance column, almost universal in its range of applications. The present stability test shows the suitability with 100 % aqueous mobile phase at high temperature at 60°C.

Fenofibrate and related substances

Column	Purospher® STAR RP-18 endcapped, 5 µm Hibar® RT 250-4.6
Mobile phase	Acetonitrile and water acidified with phosphoric acid to a pH of 2.5. Mix water and acetonitrile 30:70.
Flow rate	1.0 mL/min
Detection	UV 286 nm
Detector cell volume	13 µL
Temperature	ambient
Injection volume	20 µL
Diluent	Mobile phase
Sample	1 ppm of Fenofibrate, Fenofibrate RS A and RS B, and 2ppm Fenofibrate RS C

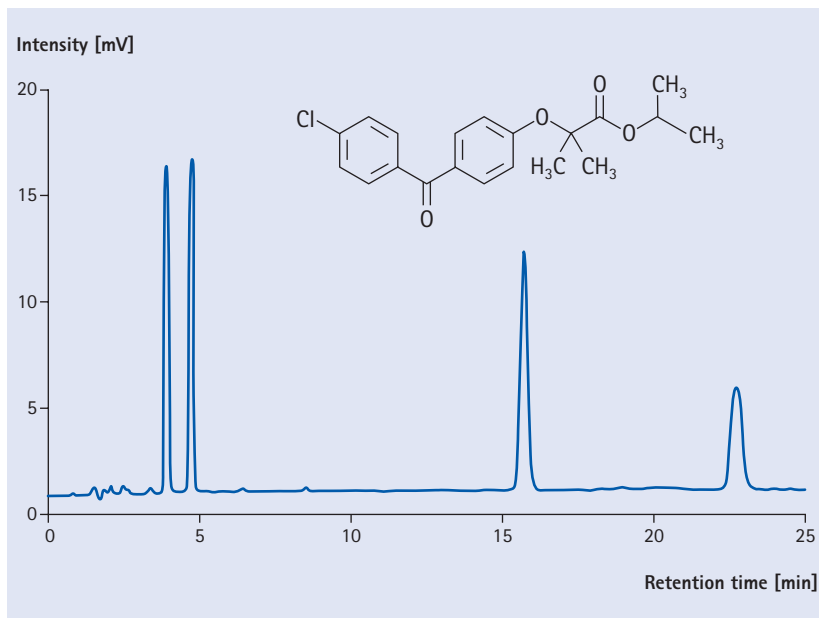

Fenofibrate is a drug of the fibrate class, which is most commonly used to reduce cholesterol levels in patients at risk of cardiovascular disease. In addition to increasing high-density lipoprotein (HDL) levels, Fenofibrate decreases the levels of low-density lipoprotein (LDL), very low-density lipoprotein (VLDL) and triglycerides.

Pioglitazone HCl

Column	Purospher® STAR RP-18 endcapped, 5 µm Hibar® RT 150-4.6
Mobile phase	Acetonitrile, 0.1 M ammonium acetate, and glacial acetic acid (25:25:1)
Flow rate	0.7 mL/min
Detection	DAD 269 nm
Detector cell volume	13 µL
Temperature	ambient
Injection volume	20 µL
Diluent	Mobile phase
Sample	50 µg/mL of Pioglitazone HCl and 13 µg/mL of benzophenone (SST solution)

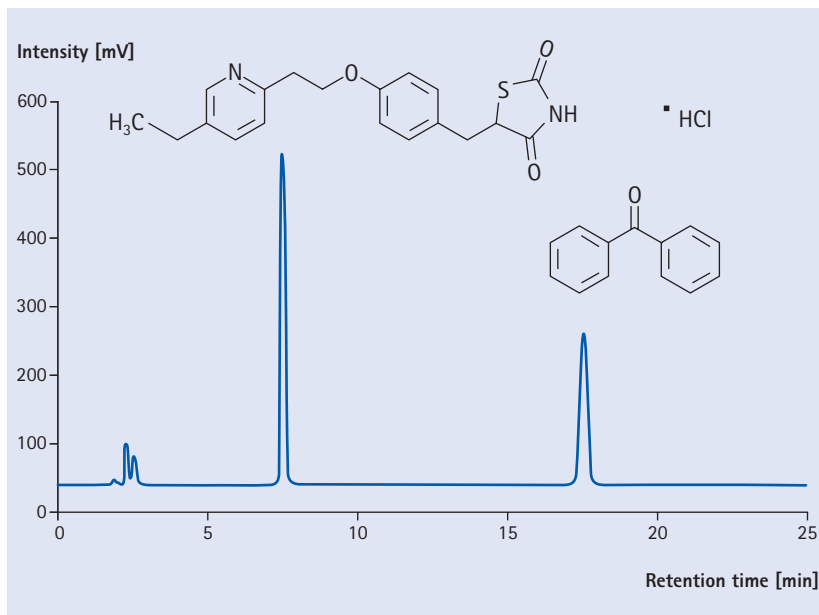

One of the best selling medications in the U.S., Pioglitazone is a prescription drug of the class thiazolidinedione (TZD) with hypoglycemic (antihyperglycemic, antidiabetic) action.

Flavonoids

Column	Purospher® STAR RP-18 endcapped, 5 µm LiChroCART® 150-4.6
Mobile phase	A: Acetonitrile B: 0.1 % Phosphoric acid
Gradient	0 min 40 % A, 3 min 40 % A, 8 min 50 % A
Flow rate	1.0 mL/min
Detection	UV 365 nm
Temperature	30°C
Injection volume	10 µL
Sample	1. Rutin 2. Morin 3. Quercetin 4. 3-Hydroxyflavon

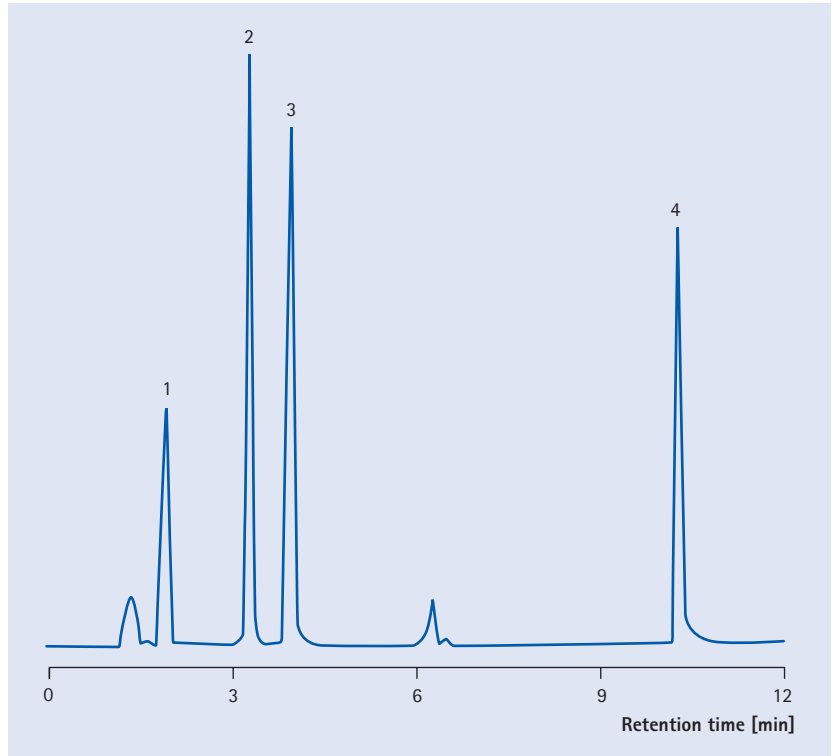

Contents of energy drinks

Column	Purospher® STAR RP-18 endcapped, 5 µm LiChroCART® 150-4.6	
Mobile phase	A: Acetonitrile B: 0.02 M Phosphate buffer pH 5.0	
Gradient	0 min 15 % A, 3 min 15 % A, 10 min 30 % A	
Flow rate	1.0 mL/min	
Detection	UV 227 nm	
Temperature	30°C	
Injection volume	10 µL	
Sample	1. Acesulfame-K	23 µg/mL
	2. Saccharin	29 µg/mL
	3. Benzoic acid	13 µg/mL
	4. Sorbic acid	14 µg/mL
	5. Caffeine	47 µg/mL
	6. Aspartame	100 µg/mL

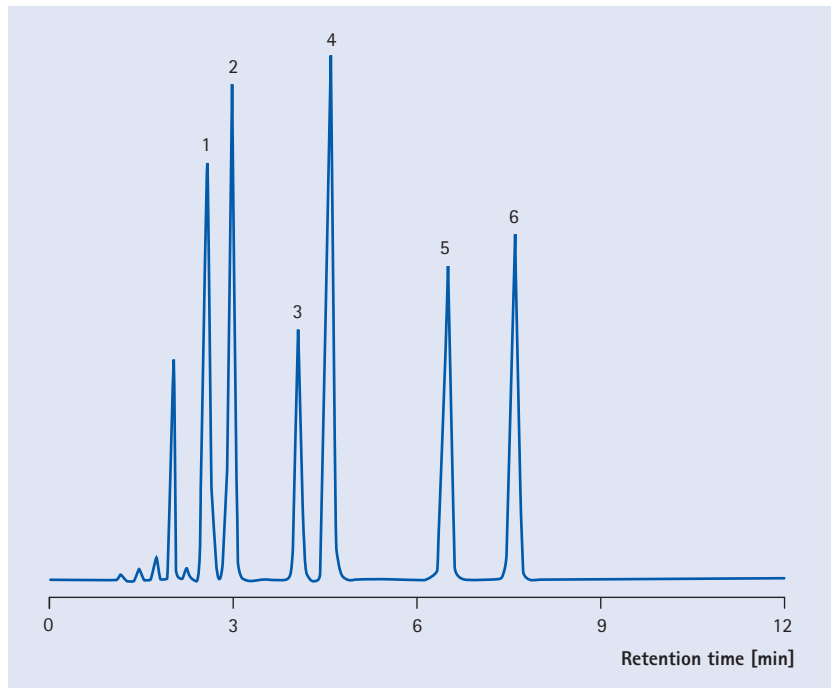

Analytical HPLC

Separation of Catecholamines

Column	Purospher® STAR RP-18 endcapped, 5 µm LiChroCART® 150-4.6	
Mobile phase	A: Acetonitrile B: 0.1 % Phosphoric acid	
Gradient	0.0 min 0 % A; 15.0 min 30 % A	
Flow rate	1.0 mL/min	
Detection	UV 210 nm	
Temperature	30°C	
Injection volume	10 µL	
Sample	1. Norepinephrine	140 µg/mL
	2. Octopamine	160 µg/mL
	3. Epinephrine tartrate	190 µg/mL
	4. Dopamine	208 µg/mL
	5. DOPA	210 µg/mL
	6. Norephedrine	160 µg/mL
	7. Ephedrine hemihydrate	140 µg/mL
	8. N-Methylephedrine	170 µg/mL

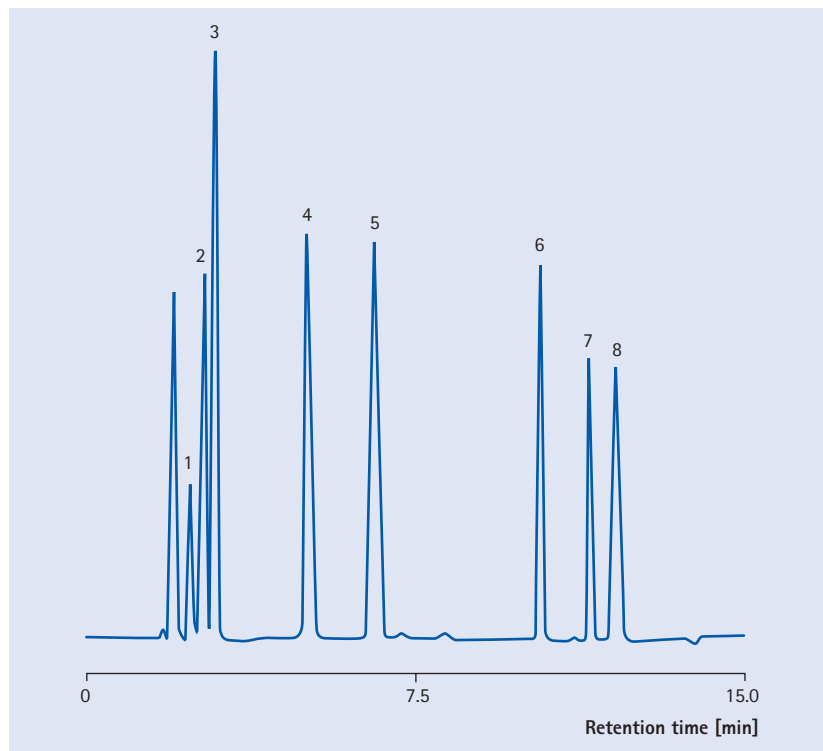

Separation of Carbidopa

Column	Purospher® STAR RP-18 endcapped, 5 µm LiChroCART® 150-4.6	
Mobile phase	A: Methanol B: 20 mM Potassium dihydrogenphosphate buffer pH 4.3	
Gradient	0.0 – 2.4 min	1 % A
	2.5 – 15.0 min	14 % A
Flow rate	1.0 mL/min	
Detection	UV 282 nm	
Temperature	ambient	
Injection volume	5 µL	
Sample	1. 1,2,4,5 trihydroxyphenylalanine	125 µg/mL
	2. Levodopa	235 µg/mL
	3. Methyldopa	160 µg/mL
	4. Dopamine	190 µg/mL
	5. Carbidopa	175 µg/mL
	6. 3,4-dihydroxyphenylacetic acid	185 µg/mL
	7. 3-o-Methylcarbidopa	140 µg/mL

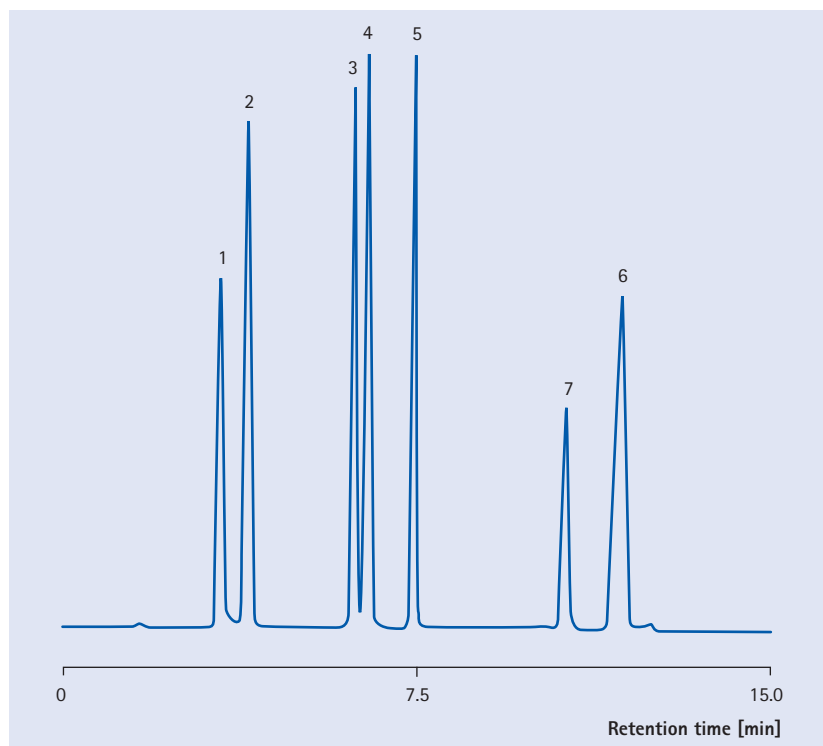

Purospher® STAR RP-8 endcapped

Ideal for less hydrophobic compounds

Purospher® STAR RP-8 endcapped, like Purospher® STAR RP-18 endcapped, is based on high purity silica and an almost complete surface coverage. Thus, Purospher® STAR RP-8 provides excellent peak symmetry for acidic, basic and even chelating compounds, highest column efficiency in terms of the number of theoretical plates, and exceptional stability from pH 1.5 to 10.5.

In addition, Purospher® STAR RP-8 endcapped columns offer a wide applicability. As the sorbent is less hydrophobic than Purospher® STAR RP-18 endcapped, analytes will typically elute faster on the C8 phase. Purospher® STAR RP-8 endcapped provides enhanced selectivity for positional isomers, and symmetrical peak shapes for strongly basic and less hydrophobic compounds. Like all other Purospher® HPLC columns, Purospher® STAR RP-8 endcapped columns are available in a large number of different hardware formats.

Purospher® STAR RP-8 endcapped benefits

- Enhanced selectivity for positional isomers
- Excellent peak symmetry for less hydrophobic and basic compounds

Specification of Purospher® STAR RP-8 endcapped

Sorbent characteristics	High purity C8-modified silica gel with endcapping	
Metal content	Na, Ca, Mg, Al: 1 ppm; Fe: 3 ppm	
Particle shape	spherical	
Particle size	2 µm, 3 µm and 5 µm	
Pore size	12 nm (120 Å)	
Pore volume	1.1 mL/g	
Specific surface area	330 m ² /g	
Carbon load	17 %	
Coverage of the surface	3 µmol/m ²	
Efficiency	5 µm	>80,000 N/m
	3 µm	>130,000 N/m
	2 µm	>180,000 N/m
pH range	pH 1.5 – 10.5	
Shipping eluent	Acetonitrile/Water	

► Customized packings
Always the right column
page 366

Accessories for particulate
HPLC columns:

► LiChroCART® cartridge
Different lengths, different
internal diameter
page 373

► Hibar® column
page 375

Purospher® STAR RP-8 endcapped

Ordering information – Purospher® STAR RP-8 endcapped, stainless steel cartridges LiChroCART®

Product	Ordering No.	Particle size	Dimension length	Dimension i.d.	Contents of one package
Purospher® STAR RP-8 endcapped, custom packed	1.50229.7220	3 µm	30 mm	2 mm	1 piece
Purospher® STAR RP-8 endcapped, custom packed	1.50234.7220	3 µm	55 mm	2 mm	1 piece
Purospher® STAR RP-8 endcapped, custom packed	1.50302.7220	3 µm	30 mm	4 mm	1 piece
Purospher® STAR RP-8 endcapped, custom packed	1.50228.7220	3 µm	55 mm	4 mm	1 piece
Purospher® STAR RP-8 endcapped, custom packed	1.50171.7220	3 µm	75 mm	4 mm	1 piece
Purospher® STAR RP-8 endcapped	1.50274.0001	5 µm	125 mm	2 mm	1 piece
Purospher® STAR RP-8 endcapped	1.50038.0001	5 µm	125 mm	3 mm	1 piece
Purospher® STAR RP-8 endcapped	1.50273.0001	5 µm	250 mm	3 mm	1 piece
Purospher® STAR RP-8 endcapped	1.50270.0001	5 µm	4 mm	4 mm	10 pieces
Purospher® STAR RP-8 endcapped	1.50271.0001	5 µm	125 mm	4 mm	1 piece
Purospher® STAR RP-8 endcapped	1.50272.0001	5 µm	250 mm	4 mm	1 piece
Purospher® STAR RP-8 endcapped	1.50031.0001	5 µm	150 mm	4.6 mm	1 piece
Purospher® STAR RP-8 endcapped	1.50032.0001	5 µm	250 mm	4.6 mm	1 piece
Purospher® STAR RP-8 endcapped	1.50276.0001	5 µm	250 mm	10 mm	1 piece

The LiChroCART® columns (75, 125, 150 and 250 mm length) in the list above (2, 3, 4 and 4.6 mm i.d.) require part number 1.51486.0001 manu-CART® cartridge column holder, which can be used to hold one cartridge column with or without a 4–4 mm guard column. LiChroCART® columns 250–10 mm require part number 1.51419.0001 manu-CART® 10. The short LiChroCART® columns (30 and 55 mm length) can be ordered as a set including the corresponding cartridge holder and one cartridge, or as a pack of 3 cartridges without cartridge holder. Additional dimensions available as customized packings see page 366. The separate part numbers for the cartridge are as follows. 1.50227.0001 LiChroCART® cartridge holder for 30 mm cartridge 1.50226.0001 LiChroCART® cartridge holder for 55 mm cartridge.

Ordering information – Purospher® STAR RP-8 endcapped, stainless steel columns Hibar® RT

Product	Ordering No.	Particle size	Dimension length	Dimension i.d.	Contents of one package
Purospher® STAR RP-8 endcapped	1.50750.0001	3 µm	150 mm	3 mm	1 piece
Purospher® STAR RP-8 endcapped, custom packed	1.50009.7220	3 µm	150 mm	4.6 mm	1 piece
Purospher® STAR RP-8 endcapped, custom packed	1.00424.7220	3 µm	250 mm	4.6 mm	1 piece
Purospher® STAR RP-8 endcapped	1.50644.0001	5 µm	150 mm	3 mm	1 piece
Purospher® STAR RP-8 endcapped	1.50033.0001	5 µm	125 mm	4 mm	1 piece
Purospher® STAR RP-8 endcapped	1.50035.0001	5 µm	250 mm	4 mm	1 piece
Purospher® STAR RP-8 endcapped	1.51453.0001	5 µm	150 mm	4.6 mm	1 piece
Purospher® STAR RP-8 endcapped	1.51454.0001	5 µm	250 mm	4.6 mm	1 piece

The Hibar® RT columns are complete with endfittings. When using a guard column with a Hibar® RT column, we recommend part number 1.51487.0001 guard column cartridge holder for 4–4 mm guard column cartridges LiChroCART®. Additional dimensions available as customized packings see page 366.

Separation examples Purospher® STAR RP-8 endcapped
Caffeine Et derivatives

Column	Purospher® STAR RP-8 endcapped, 5 µm LiChroCART® 125-4
Mobile phase	Methanol/Ammonia Acetate Buffer pH 3.5 (Gradient)
Flow rate	1.0 mL/min
Detection	UV 270 nm
Temperature	ambient
Injection volume	10 µL
Sample	1. 1-Methylxanthine 2. 1,3-Dimethyl uric acid 3. Paracetamol 4. Theobromine 5. 1,7-Dimethyl uric acid 6. 1,7-Dimethyl xanthine 7. Theophylline 8. Caffeine

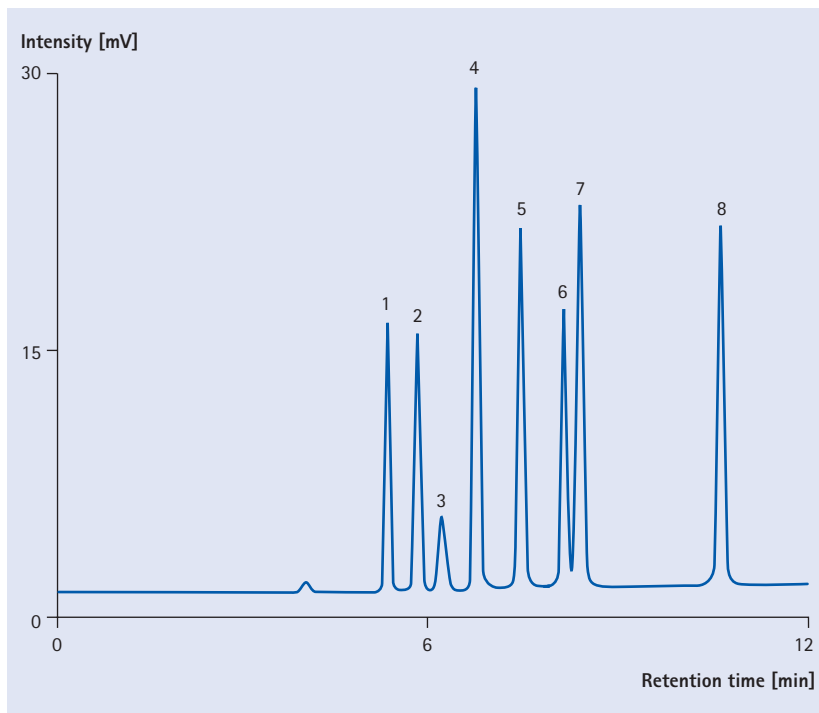

Separation of Diclofenac Na and Related Compound

Column	Purospher® STAR RP-8 endcapped, 5 µm Hibar® RT 250-4.6
Mobile phase	Buffer: 0.5 gm/L phosphoric acid and 0.8 gm/L sodium dihydrogen phosphate. Adjust pH to 2.5 with orthophosphoric acid and Methanol 36:64
Flow rate	0.9 mL/min
Detection	UV 254 nm
Temperature	ambient
Injection volume	20 µL

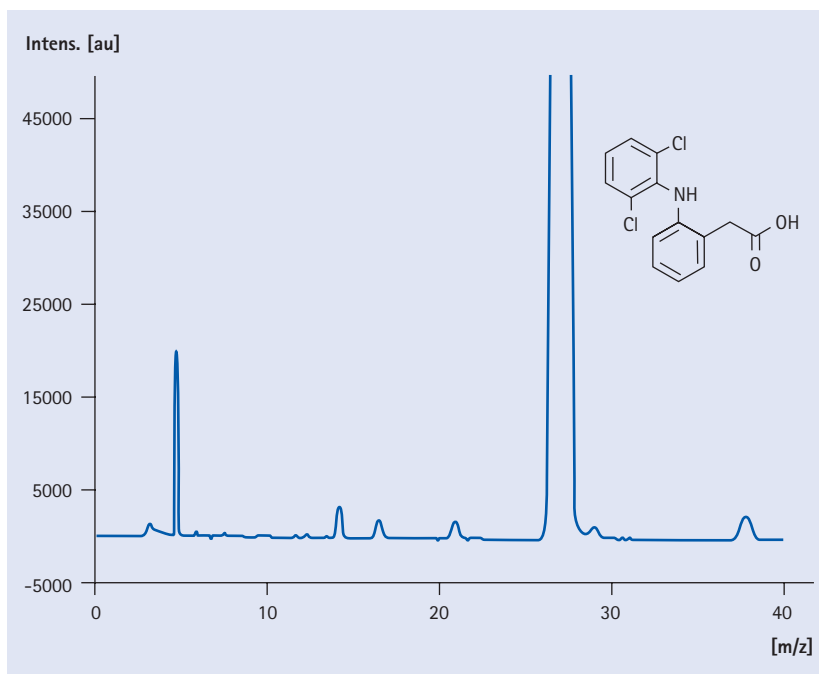

Purospher® STAR Phenyl

Enhanced selectivity for aromatic compounds

Phenyl HPLC columns are the best alternative to RP-8 or RP-18 columns for the separation of aromatic compounds, and compounds containing aromatic groups. Purospher® STAR Phenyl can retain analytes via several different mechanisms, including π - π interactions between the overlap of the delocalized electrons on the analyte and the stationary phase phenyl group, and via partitioning between the mobile phase and the hydrophobic aryl-alkyl phase.

Purospher® STAR Phenyl columns are based on high-purity silica particles, which provide symmetrical peaks for basic compounds, as well as high stability and excellent reproducibility. Furthermore, hydrophobic compounds elute much faster with Purospher® STAR Phenyl columns than with C-18 columns.

Purospher® STAR Phenyl benefits

- Enhanced selectivity for aromatic compounds
- Low silanol activity
- Excellent pH stability from 1.5 to 10.5
- Suitable for up to 100 % aqueous mobile phases

Specification of Purospher® STAR Phenyl

Sorbent characteristics	High purity C8-modified silica gel with endcapping	
Metal content	Na, Ca, Mg, Al: 1 ppm; Fe: 3 ppm	
Particle shape	spherical	
Particle size	2 μ m, 3 μ m and 5 μ m	
Pore size	12 nm (120 Å)	
Pore volume	1.1 mL/g	
Specific surface area	330 m ² /g	
Carbon load	12.5 %	
Coverage of the surface	3 μ mol/m ²	
Efficiency	5 μ m	>80,000 N/m
	3 μ m	>130,000 N/m
	2 μ m	>180,000 N/m
pH range	pH 1.5 – 10.5	
Shipping eluent	Acetonitrile/Water	

► Customized packings
Always the right column
page 366

Accessories for particulate
HPLC columns:

► LiChroCART® cartridge
Different lengths, different
internal diameter
page 373

► Hibar® column
page 375



Ordering information – Purospher® STAR Phenyl, stainless steel cartridges LiChroCART®

Product	Ordering No.	Particle size	Dimension length	Dimension i.d.	Contents of one package
Purospher® STAR Phenyl	1.51922.0001	5 µm	150 mm	4.6 mm	1 piece
Purospher® STAR Phenyl	1.51921.0001	5 µm	250 mm	4.6 mm	1 piece

The LiChroCART® columns (150 and 250 mm length) in the list above (4.6 mm i.d.) require part number 1.51486.0001 manu-CART® cartridge column holder, which can be used to hold one cartridge column with or without a 4–4 mm guard column. Additional dimensions available as customized packings see page 366.

Ordering information – Purospher® STAR Phenyl, stainless steel columns Hibar® RT

Product	Ordering No.	Particle size	Dimension length	Dimension i.d.	Contents of one package
Purospher® STAR Phenyl	1.50631.0001	3 µm	150 mm	3 mm	1 piece
Purospher® STAR Phenyl	1.51920.0001	5 µm	150 mm	3 mm	1 piece
Purospher® STAR Phenyl	1.51919.0001	5 µm	150 mm	4.6 mm	1 piece
Purospher® STAR Phenyl	1.51918.0001	5 µm	250 mm	4.6 mm	1 piece

The Hibar® RT columns are complete with endfittings. When using a guard column with a Hibar® RT column, we recommend part number 1.51487.0001 guard column cartridge holder for 4–4 mm guard column cartridges LiChroCART®. Additional dimensions available as customized packings see page 366.

Ordering information – Validation kits, Purospher® STAR Phenyl, stainless steel cartridges LiChroCART®

Product	Ordering No.	Particle size	Dimension length	Dimension i.d.	Contents of one package
Purospher® STAR Phenyl, validation kit (3 columns of 3 different sorbent batches)	1.51922.1003	5 µm	150 mm	4.6 mm	1 set
Purospher® STAR Phenyl, validation kit (3 columns of 3 different sorbent batches)	1.51921.1003	5 µm	250 mm	4.6 mm	1 set

Ordering information – Validation kits, Purospher® STAR Phenyl, stainless steel columns Hibar® RT

Product	Ordering No.	Particle size	Dimension length	Dimension i.d.	Contents of one package
Purospher® STAR Phenyl, validation kit (3 columns of 3 different sorbent batches)	1.51920.1003	5 µm	150 mm	3 mm	1 set
Purospher® STAR Phenyl, validation kit (3 columns of 3 different sorbent batches)	1.51919.1003	5 µm	150 mm	4.6 mm	1 set
Purospher® STAR Phenyl, validation kit (3 columns of 3 different sorbent batches)	1.51918.1003	5 µm	250 mm	4.6 mm	1 set

Sander & Wise SRM 869b Test

Purospher® STAR RP-18 endcapped, 5 µm

Purospher® STAR Phenyl, 5 µm

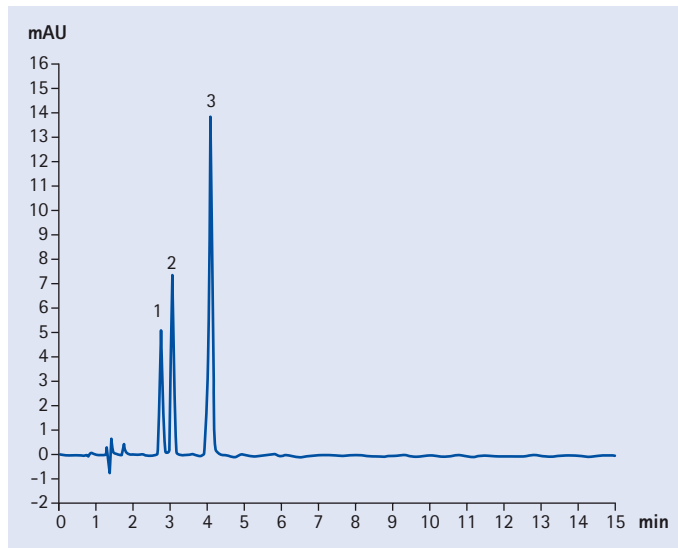
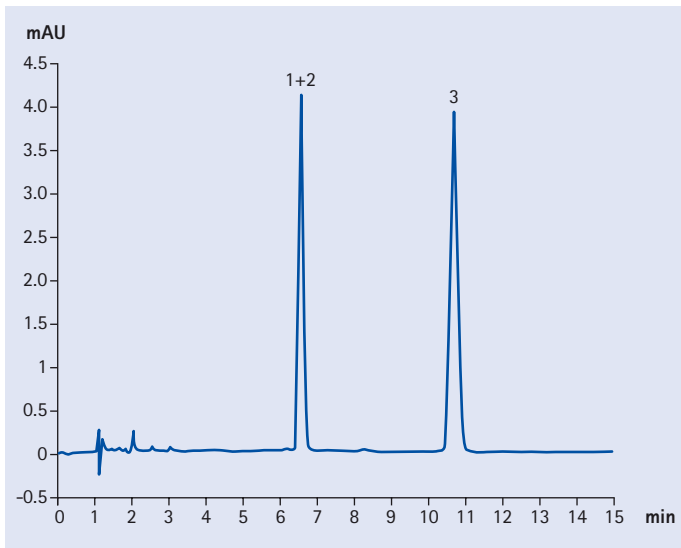

Mobile phase	Acetonitrile/water 90/10 (v/v)
Flow rate	1.3 mL/min
Detection	UV 254 nm
Injection volume	1 µL
Sample	1. PhPh (Phenanthro-[3,4-c]-phenanthrene) 2. BaP (Benzo[a]pyrene) 3. TBN (Tetrabenzonaphthalene)

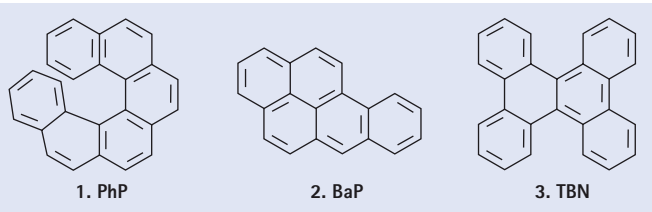

Separation of nucleobases under aqueous conditions

Column	Purospher® STAR Phenyl, 5 µm Hibar® RT 150-4.6 mm
Mobile phase	10 mM Ammonium acetate buffer pH=3.0
Flow rate	1.3 mL/min
Detection	UV 270 nm
Temperature	35°C
Injection volume	1 µL
Sample	1. Uracil 2. Cytosine 3. Thymine 4. Adenine

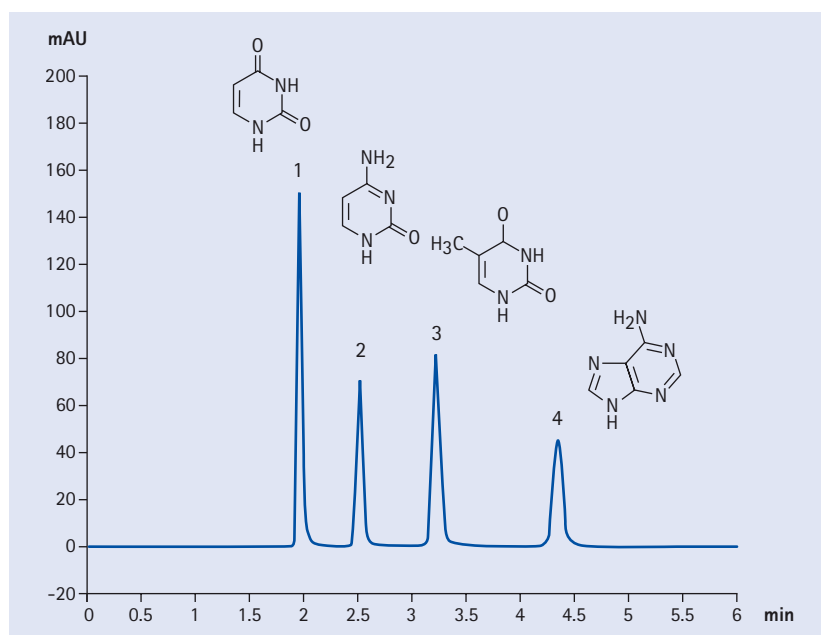

Purospher® STAR Si (Silica) and NH₂ (Amino-phase)

Purospher® STAR HPLC columns based on highest purity silica are also available for normal phase separations.

Purospher® STAR Si (Silica) offers highest separation efficiency for normal-phase chromatography of low molecular weight compounds soluble in organic solvents.

Purospher® STAR NH₂ (Amino-phase) is primarily designed for carbohydrate analysis with a typical mobile phase consisting of acetonitrile and water. Additionally, Purospher® STAR NH₂ can also be used in the normal-phase retention mode.

Purospher® STAR Si and Purospher® STAR NH₂ benefits

- Very high separation efficiency as measured by the plate count
- Absence of metal impurities, thus giving consistently symmetrical peaks
- Extended column lifetime

Specifications of Purospher® STAR Si and Purospher® STAR NH₂

	Purospher® STAR Si	Purospher® STAR NH ₂
Sorbent characteristics	High-purity silica gel particles	with NH ₂ (Amino) modification
Metal content	Na, Ca, Mg, Al: 1 ppm; Fe: 3 ppm	Na, Ca, Mg, Al: 1 ppm; Fe: 3 ppm
Particle shape	spherical	spherical
Particle size	5 µm	5 µm
Pore size	12 nm (120 Å)	12 nm (120 Å)
Pore volume	1.1 mL/g	1.1 mL/g
Specific surface area	330 m ² /g	330 m ² /g
Carbon load	–	3.5 %
Coverage of the surface	3 µmol/m ²	3 µmol/m ²
Efficiency	>50,000 N/m	>50,000 N/m
pH range	pH 2 – 7.5	pH 2 – 7.5
Shipping eluent	n-Heptane	n-Heptane



▶ **LiChrospher® 100 NH₂**
A versatile sorbent for both reversed phase and normal phase chromatography
page 336

▶ **Customized packings**
Always the right column
page 366

Accessories for particulate HPLC columns:

▶ **LiChroCART® cartridge**
Different lengths, different internal diameter
page 373

▶ **Hibar® column**
page 375

Purospher® STAR Si and Purospher® STAR NH₂

Ordering information – Purospher® STAR Si, stainless steel cartridges LiChroCART®

Product	Ordering No.	Particle size	Dimension length	Dimension i.d.	Contents of one package
Purospher® STAR Si, custom packed	1.50175.7174	3 µm	125 mm	3 mm	1 piece
Purospher® STAR Si, custom packed	1.50177.7174	3 µm	150 mm	3 mm	1 piece
Purospher® STAR Si, custom packed	1.50190.7175	5 µm	150 mm	2 mm	1 piece
Purospher® STAR Si, custom packed	1.50175.7175	5 µm	125 mm	3 mm	1 piece
Purospher® STAR Si	1.50249.0001	5 µm	4 mm	4 mm	10 pieces
Purospher® STAR Si	1.50268.0001	5 µm	125 mm	4 mm	1 piece
Purospher® STAR Si	1.50269.0001	5 µm	250 mm	4 mm	1 piece
Purospher® STAR Si	1.50356.0001	5 µm	150 mm	4.6 mm	1 piece
Purospher® STAR Si	1.50357.0001	5 µm	250 mm	4.6 mm	1 piece

The LiChroCART® columns (75, 125, 150 and 250 mm length) in the list above (4 mm i.d.) require part number 1.51486.0001 manu-CART® cartridge column holder, which can be used to hold one cartridge column with or without a 4–4 mm guard column. Additional dimensions available as customized packings see page 366.

Ordering information – Purospher® STAR Si, stainless steel columns Hibar® RT

Product	Ordering No.	Particle size	Dimension length	Dimension i.d.	Contents of one package
Purospher® STAR Si, custom packed	1.50181.7174	3 µm	125 mm	4 mm	1 piece
Purospher® STAR Si, custom packed	1.50182.7174	3 µm	250 mm	4 mm	1 piece
Purospher® STAR Si, custom packed	1.50012.7174	3 µm	125 mm	4.6 mm	1 piece
Purospher® STAR Si, custom packed	1.50009.7174	3 µm	150 mm	4.6 mm	1 piece
Purospher® STAR Si, custom packed	1.50009.7175	5 µm	150 mm	4.6 mm	1 piece

The Hibar® RT columns are complete with endfittings. When using a guard column with a Hibar® RT column, we recommend part number 1.51487.0001 guard column cartridge holder for 4–4 mm guard column cartridges LiChroCART®. Additional dimensions available as customized packings see page 366.

Ordering information – Purospher® STAR NH₂, stainless steel cartridges LiChroCART®

Product	Ordering No.	Particle size	Dimension length	Dimension i.d.	Contents of one package
Purospher® STAR NH ₂	1.50190.7177	5 µm	250 mm	2 mm	1 piece
Purospher® STAR NH ₂	1.50177.7177	5 µm	250 mm	3 mm	1 piece
Purospher® STAR NH ₂	1.50267.0001	5 µm	4 mm	4 mm	10 pieces
Purospher® STAR NH ₂	1.50244.0001	5 µm	125 mm	4 mm	1 piece
Purospher® STAR NH ₂	1.50245.0001	5 µm	250 mm	4 mm	1 piece
Purospher® STAR NH ₂	1.50247.0001	5 µm	150 mm	4.6 mm	1 piece
Purospher® STAR NH ₂	1.50248.0001	5 µm	250 mm	4.6 mm	1 piece

The LiChroCART® columns (75, 125, 150 and 250 mm length) in the list above (4 mm i.d.) require part number 1.51486.0001 manu-CART® cartridge column holder, which can be used to hold one cartridge column with or without a 4–4 mm guard column. Additional dimensions available as customized packings see page 366.

Ordering information – Purospher® STAR NH₂, stainless steel columns Hibar® RT

Product	Ordering No.	Particle size	Dimension length	Dimension i.d.	Contents of one package
Purospher® STAR NH ₂ , custom packed	1.50182.7177	5 µm	250 mm	4 mm	1 piece
Purospher® STAR NH ₂ , custom packed	1.50009.7177	5 µm	150 mm	4.6 mm	1 piece

The Hibar® RT columns are complete with endfittings. When using a guard column with a Hibar® RT column, we recommend part number 1.51487.0001 guard column cartridge holder for 4–4 mm guard column cartridges LiChroCART®. Additional dimensions available as customized packings see page 366.

Separation examples on Purospher® STAR Si and Purospher® STAR NH₂

Carbohydrates

Column	Purospher® STAR NH ₂ , 5 µm LiChroCART® 250-4
Mobile phase	Acetonitrile / Water 75:25
Flow rate	1.0 mL/min
Detection	RI
Temperature	30°C
Injection volume	10 µL
Sample	1. Xylose 2. Fructose 3. Glucose 4. Saccharose 5. Maltose 6. Lactose

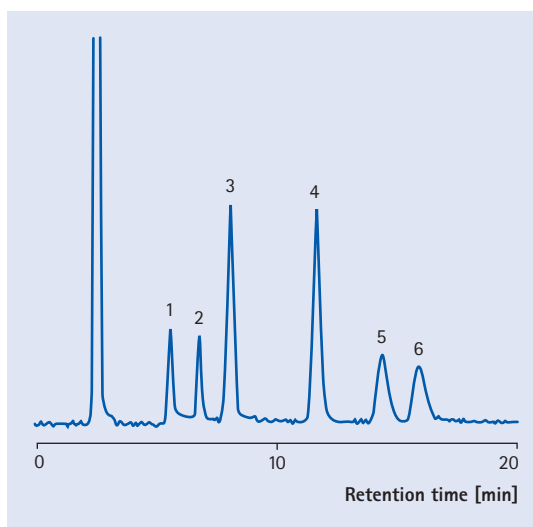

Anisoles

Column	Purospher® STAR Si, 5 µm LiChroCART® 125-4
Mobile phase	Heptane/Dioxane 95/5 v/v
Flow rate	2 mL/min
Detection	UV 254 nm response fast
Temperature	Room temperature
Injection volume	5 µL
Sample	1. Anisole 2. 3-Nitroanisole 3. 4-Nitroanisole 4. 2-Nitroanisole

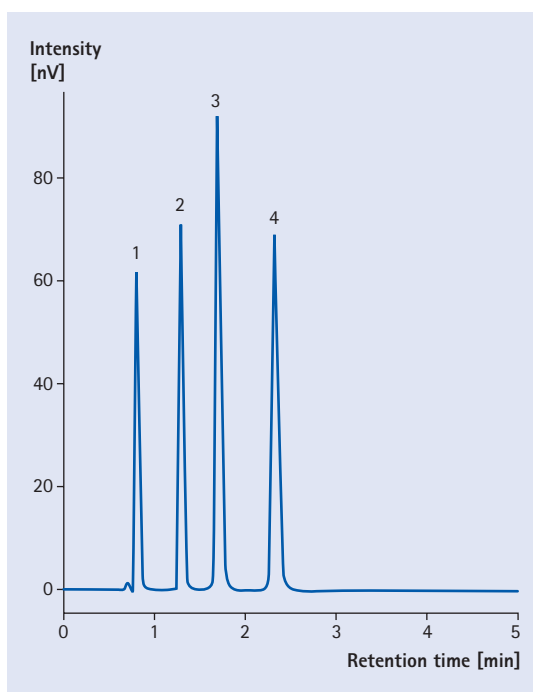

Purospher® STAR UHPLC columns for ultra fast HPLC

Where speed meets performance

Speed, resolution and sensitivity

Fast and ultra-fast separations have become particularly important due to the need for high sample throughput and higher productivity in daily lab work. Using UHPLC methods with short columns, narrow inner diameters and small particles sizes, it is possible to speed up analyses up to ten-fold.

Available as optimized 2 μm and 3 μm particulate silica, these UHPLC columns based on Purospher® STAR are ideal for ultra-fast applications, where resolution, sensitivity and sample throughput are crucial. They are the first choice for high-throughput screening & QC analyses, process monitoring, method development, and LC-MS applications. The **Purospher® STAR 3 μm UHPLC columns** are recommended for difficult samples where clogging and back-pressure present an issue.

Purospher® STAR UHPLC columns benefits

- In UHPLC environment, speed is increased by a factor of 10
- Solvent consumption is drastically cut (up to 90 %)
- Excellent peak shape for all types of acidic, basic and metal chelating analytes due to high purity silica
- pH stability from pH 1.5 – 10.5 for an extremely wide application range
- Enhanced sensitivity due to improved signal-to-noise ratio



► **Purospher® STAR RP-18 endcapped**
The versatility you need!
page 269

► **Purospher® STAR RP-8 endcapped** Ideal for less hydrophobic compounds
page 283

► **Purospher® STAR Phenyl**
Enhanced selectivity for aromatic compounds
page 286

Purospher® STAR UHPLC columns are available in different selectivities and particle sizes:

- **Purospher® STAR RP-18 endcapped UHPLC columns** cover almost all demanding separations with tailing-free chromatograms, due to its balanced selectivity.
- **Purospher® STAR RP-8 endcapped UHPLC columns** are the best alternative for separation of less hydrophobic compounds.
- **Purospher® STAR Phenyl UHPLC columns** show an enhanced selectivity to compared for separation of aromatic compounds, due to π - π interactions.

Ordering information – Purospher® STAR RP-18e, stainless steel Hibar® HR UHPLC columns

Product	Ordering No	Particle size	Dimension length	Dimension i.d.	Contents of one package
Purospher® STAR RP-18 endcapped	1.50645.0001	2 µm	30 mm	2.1 mm	1 piece
Purospher® STAR RP-18 endcapped	1.50646.0001	2 µm	50 mm	2.1 mm	1 piece
Purospher® STAR RP-18 endcapped	1.50648.0001	2 µm	100 mm	2.1 mm	1 piece
Purospher® STAR RP-18 endcapped	1.50649.0001	2 µm	150 mm	2.1 mm	1 piece
Purospher® STAR RP-18 endcapped	1.50650.0001	3 µm	30 mm	2.1 mm	1 piece
Purospher® STAR RP-18 endcapped	1.50651.0001	3 µm	50 mm	2.1 mm	1 piece
Purospher® STAR RP-18 endcapped	1.50653.0001	3 µm	100 mm	2.1 mm	1 piece
Purospher® STAR RP-18 endcapped	1.50654.0001	3 µm	150 mm	2.1 mm	1 piece
Purospher® STAR RP-18 endcapped	1.50655.0001	3 µm	250 mm	2.1 mm	1 piece

Ordering information – Validation kit, Purospher® STAR RP-18e, stainless steel Hibar® HR UHPLC columns

Product	Ordering No	Particle size	Dimension length	Dimension i.d.	Contents of one package
Purospher® STAR RP-18 endcapped, validation kit (3 columns of 3 different sorbent batches)	1.50648.1003	2 µm	100 mm	2.1 mm	1 set

Ordering information – Purospher® STAR RP-8e, stainless steel Hibar® HR UHPLC columns

Product	Ordering No	Particle size	Dimension length	Dimension i.d.	Contents of one package
Purospher® STAR RP-8 endcapped	1.50630.0001	2 µm	50 mm	2.1 mm	1 piece
Purospher® STAR RP-8 endcapped	1.50629.0001	2 µm	100 mm	2.1 mm	1 piece
Purospher® STAR RP-8 endcapped	1.50674.0001	3 µm	50 mm	2.1 mm	1 piece
Purospher® STAR RP-8 endcapped	1.50675.0001	3 µm	100 mm	2.1 mm	1 piece

Ordering information – Purospher® STAR Phenyl, stainless steel Hibar® HR UHPLC columns

Product	Ordering No	Particle size	Dimension length	Dimension i.d.	Contents of one package
Purospher® STAR Phenyl	1.51013.0001	2 µm	50 mm	2.1 mm	1 piece
Purospher® STAR Phenyl	1.51014.0001	2 µm	100 mm	2.1 mm	1 piece
Purospher® STAR Phenyl	1.50672.0001	3 µm	50 mm	2.1 mm	1 piece
Purospher® STAR Phenyl	1.50673.0001	3 µm	100 mm	2.1 mm	1 piece

Purospher® STAR UHPLC columns for ultra fast HPLC

High resolution separation of 9 Alkylphenones

Purospher® STAR RP-18 endcapped, 5 µm
LiChroCART® 150-4.6

Mobile phase	A: Water B: Acetonitrile	
Gradient	0 min	45 % B
	15 min	45 – 95 % B
	15.1–20 min re-equilibration with 45 % B	
Flow rate	1.0 mL/min	
Pressure	105 bar	
Detection	UV 247 nm	
Temperature	40°C	
Injection volume	10 µL	
Sample	1. Acetanilide 2. Acetophenone 3. Propiophenone 4. Butyrophenone 5. Benzophenone 6. Valerophenone 7. Hexanophenone 8. Heptanophenone 9. Octanophenone	

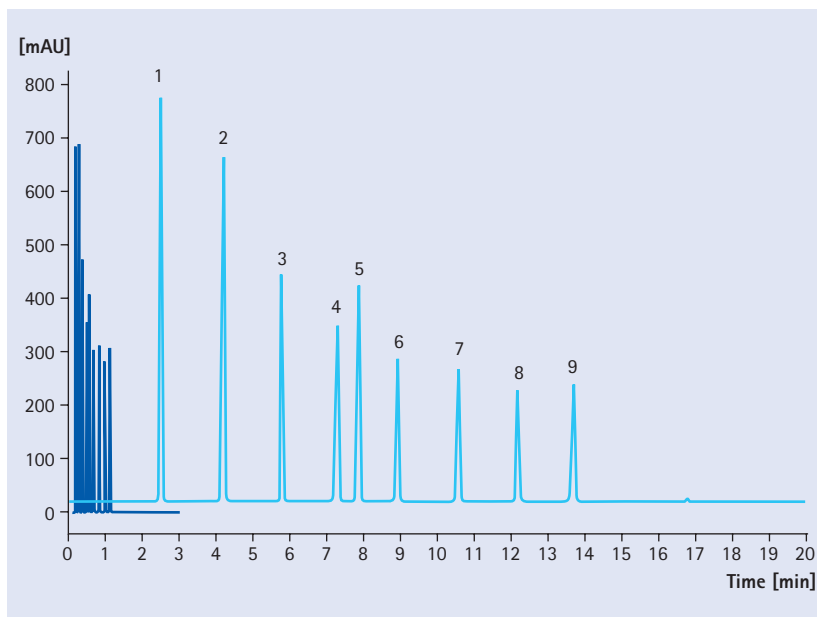

Purospher® STAR RP-18 endcapped, 2 µm
Hibar® HR 50-2.1

Mobile phase	A: Water B: Acetonitrile	
Gradient	0 min	55 % B
	0.8 min	55 – 100 % B
	0.9 – 2 min re-equilibration with 55 % B	
Flow rate	1.1 mL/min	
Pressure	505 bar	
Detection	UV 247 nm	
Temperature	40°C	
Injection volume	1 µL	
Sample	1. Acetanilide 2. Acetophenone 3. Propiophenone 4. Butyrophenone 5. Benzophenone 6. Valerophenone 7. Hexanophenone 8. Heptanophenone 9. Octanophenone	

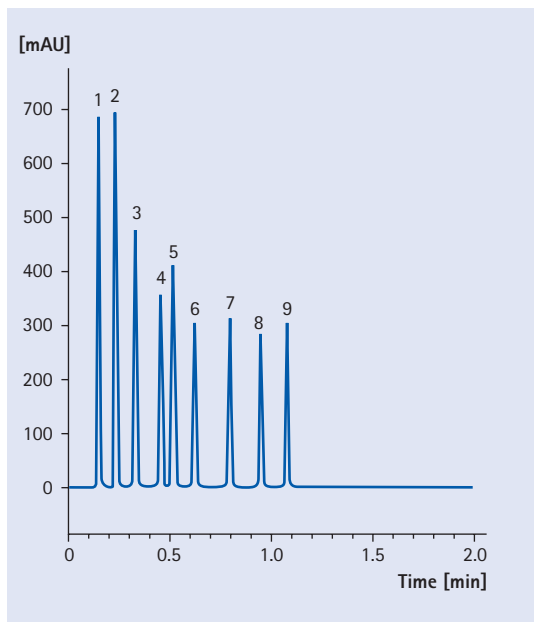

High resolution at lower column back-pressure

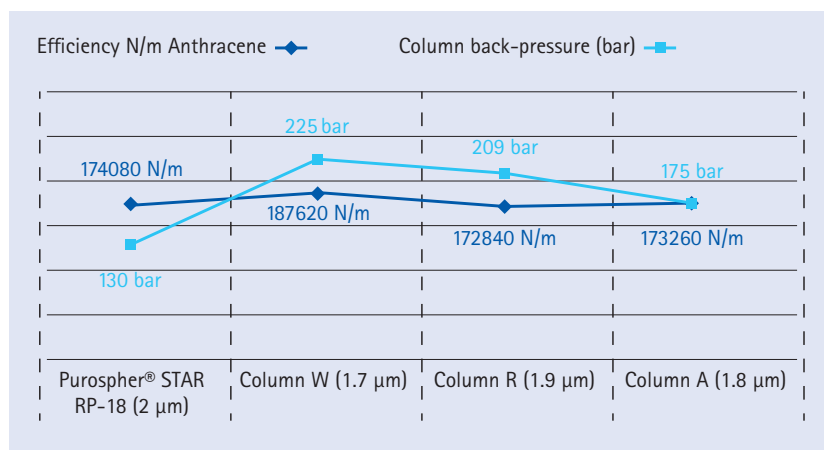

Column dimension	50 x 2.1 mm
Mobile phase	Acetonitrile / Water 60:40
Flow rate	0.350 mL/min
Injection volume	0.2 µL
Sample	1. Thiourea 2. Biphenyl-2-ol 3. Progesterone 4. Hexanophenone 5. Anthracene

Although UHPLC is typically performed with a particle size smaller than 2 µm, Merck Millipore employs 2 µm particles due to two important factors. Firstly, column efficiency and back-pressure depend on the particle size of the column material. Secondly, column efficiency is also highly influenced by instrument effects.

When UHPLC columns with 1.7 µm, 1.8 µm, 1.9 µm and 2 µm particles are compared on the same instrument and under the same conditions, the results show no significant difference in efficiency. However, column pressure varies substantially among the different particle size materials. For example, a 1.7 µm particulate material has over 100 bar higher column back-pressure, compared to a 2 µm material. As a result a 2 µm particulate material shows a significant better pressure to efficiency ratio than sub 2 µm particles.

Ultra fast separation of strychnine and brucine

Column	Purospher® STAR RP-18 endcapped, 2 µm Hibar® HR 50-2.1 mm
Mobile phase	A: 0.1 % Phosphoric acid B: Acetonitrile
Gradient	6 min 8 % - 17 % B 8 min 30 % B 8.1-12 min re-equilibration with 8 % B
Flow rate	0.9 mL/min
Detection	UV 260 nm
Temperature	40°C
Injection volume	5 µL
Sample	Strychnos tree seed (1:30 diluted) 1. Strychnine 2. Brucine

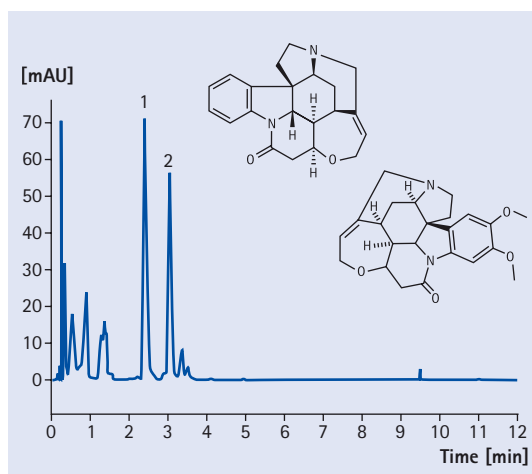

Perfectly suitable at high pH

The separation of Omeprazole requires basic conditions due to the fact that this compound is unstable under acidic conditions. The separation at pH 2 clearly shows the decomposition products of omeprazole. Separation of omeprazole at high pH shows good stability (see separation example below).

Omeprazole (OMZ) is a proton pump inhibitor used in the treatment of dyspepsia, peptic ulcer disease, gastroesophageal reflux disease and Zollinger–Ellison syndrome. Its mechanism of action is by selectively inhibiting the hydrogen–potassium adenosine triphosphatase enzyme (H⁺/K⁺ ATPase) of the parietal cells, leading to a reduction of the gastric acid secretion. Omeprazole is one of the most widely prescribed drugs internationally.

Separation of Omeprazole

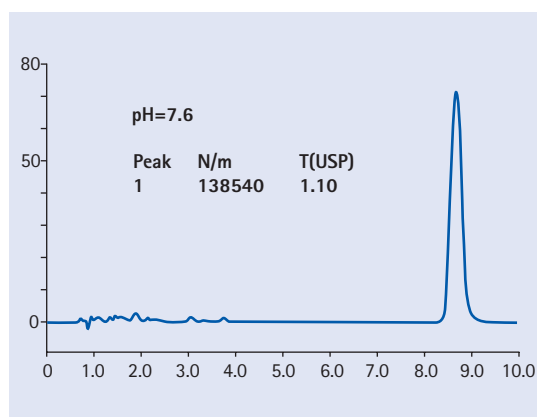
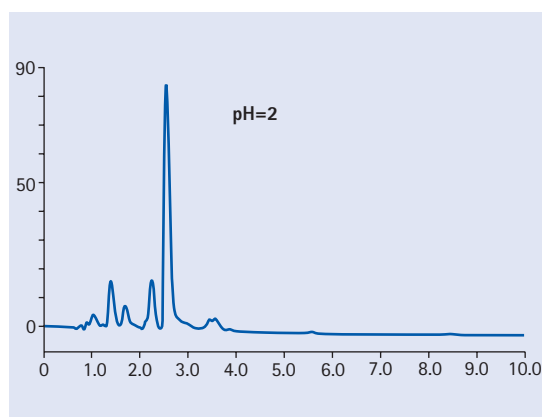

Column	Purospher® STAR RP-18 endcapped, 2 µm Hibar® HR 50-2.1 mm
Mobile phase	1.) Acetonitrile / 20 mM Na-Phosphate buffer pH = 2 25/75 v/v 2.) Acetonitrile / 20 mM Na-Phosphate buffer pH = 7.6 25/75 v/v
Flow rate	167 µL/min
Detection	UV 280 nm
Temperature	30°C
Injection volume	1.1 µL
Sample	Omeprazole 20 mg
Sample preparation	20 mg Omeprazole were dissolved in 75 mL water, ultra sonic after 20 min, add 25 mL Acetonitrile and filter through a 0.2 µm filter directly into a vial.

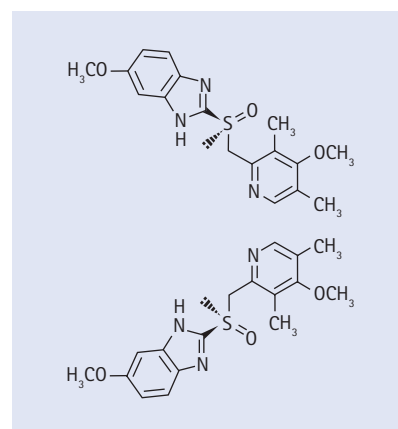

High resolution UHPLC separation of Lamotrigine & related substances

For separation of complex mixtures higher separation efficiencies are needed, provided by the new 100 mm and 150 mm (2.1 mm i.d.) UHPLC columns filled with Purospher® STAR RP-18 endcapped 2 µm particles.

Column	Purospher® STAR RP-18 endcapped, 2 µm Hibar® HR 50–2.1 mm	
	Purospher® STAR RP-18 endcapped, 2 µm Hibar® HR 150–2.1 mm	
Mobile phase	A: Buffer (14 mL Triethylamine in 1 liter water, adjusted to pH 1.9 with perchloric acid) B: Acetonitrile	
Gradient	0 min	17 % B
	16 min	17–34 % B
	16.1–25 min re-equilibration with 17 % B	
Flow rate	0.38 mL/min	
Pressure	530 bar	
Temperature	40°C	
Injection volume	2 µL	
Sample	Lamotrigine and related compound standard: 1. 2-Chloro-Lamotrigine 2. 3-Chloro-Lamotrigine 3. 4-Chloro-Lamotrigine 4. 2,5-Dichloro-Lamotrigine 5. Lamotrigine 6. 2,4-Dichloro-Lamotrigine 7. 3,5-Dichloro-Lamotrigine 8. 3,4-Dichloro-Lamotrigine 9. 2,3,5-Trichloro-Lamotrigine 10. Lamotrigine – open form	

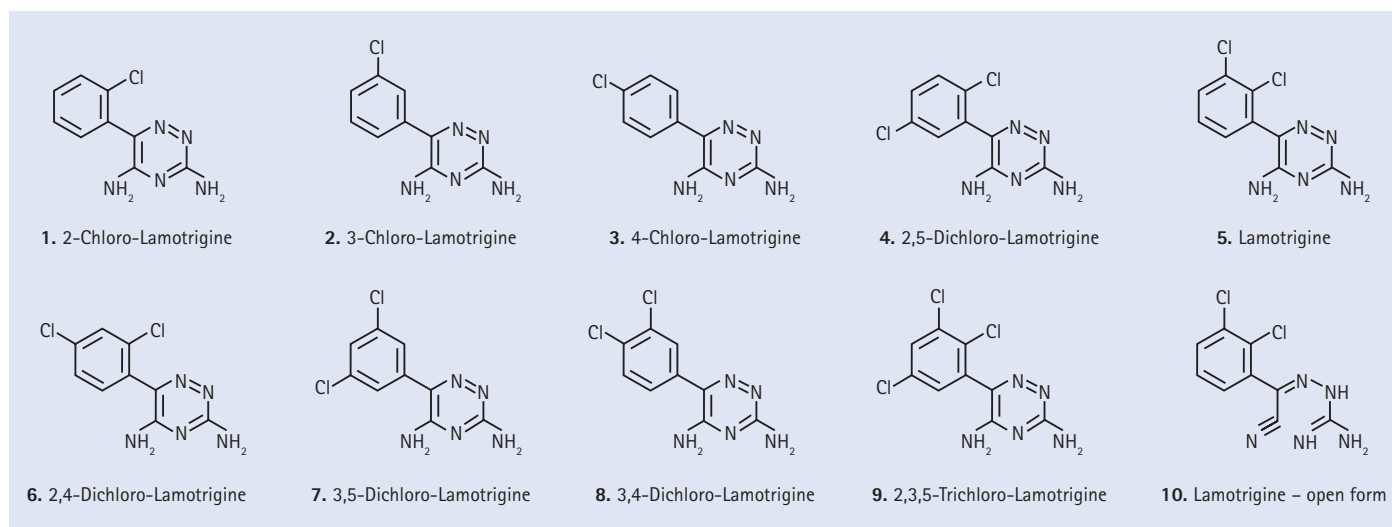
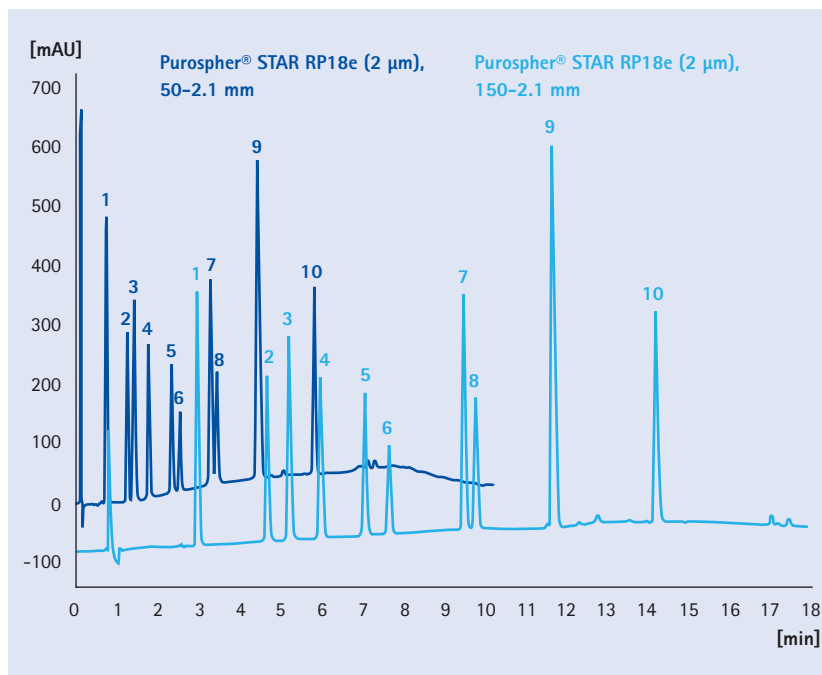

Purospher® STAR UHPLC columns for ultra fast HPLC

UHPLC-MS separation of Steroids with Purospher® STAR RP-8 endcapped (2 µm)

Column	Purospher® STAR RP-8 endcapped, 2 µm Hibar® HR 50-2.1	
Mobile phase	A: ACN + 0.1 % formic acid B: Water + 0.1 % formic acid	
Flow rate	0.4 mL/min	
Pressure drop	240 – 90 bar	
Detection	pos. ESI-MS (m/z 270-410), EICs	
Temperature	25°C	
Injection volume	1 µL	
Sample		
Compound	RT [min]	detected mass [m/z / g/Mol]
1. Fluoxymesterone	1.08	337.0
2. Boldenone	1.41	287.1
3. Methandrostenolone	1.63	301.0
4. Methyltestosterone	1.97	303.1
5. Boldenone acetate	2.91	329.1
6. Testosterone acetate	3.15	331.1
7. Nandrolone propionate	3.30	331.1
8. Testosterone propionate	3.42	345.1
9. Nandrolone phenylpropionate	3.69	407.1
10. Testosterone isocaproate	3.94	387.2

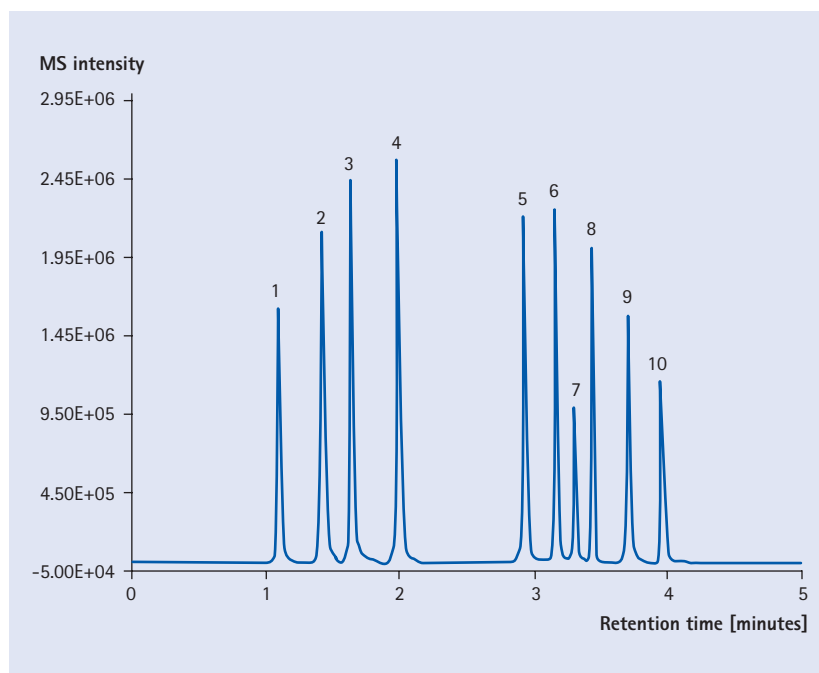

Separation of Carboxylic acids

Column	Purospher® STAR RP-8 endcapped, 2 µm Hibar® HR 50-2.1	
Mobile phase	A: Acetonitrile B: 20 mM sodium phosphate buffer pH=2.5	
Gradient	0 min	2 % A 98 % B
	0.15 min	18 % A 82 % B
	2.15 min	18 % A 82 % B
	2.3 min	32 % A 68 % B
	4 min	32 % A 68 % B
Flow rate	600 µL/min	
Pressure	287 bar	
Detection	220 nm	
Injection volume	0.2 µL	
Sample	1. Malic acid	0.94 mg/mL
	2. Succinic acid	1.06 mg/mL
	3. Glutaric acid	1.25 mg/mL
	4. 3,4-Dihydroxy-cinnamic acid	0.12 mg/mL
	5. 4-Hydroxy-cinnamic acid	0.04 mg/mL
	6. Sorbic acid	0.20 mg/mL
	7. Benzoic acid	0.05 mg/mL
	8. 2-Hydroxybenzoic acid	0.24 mg/mL
	9. Cinnamic acid	0.06 mg/mL

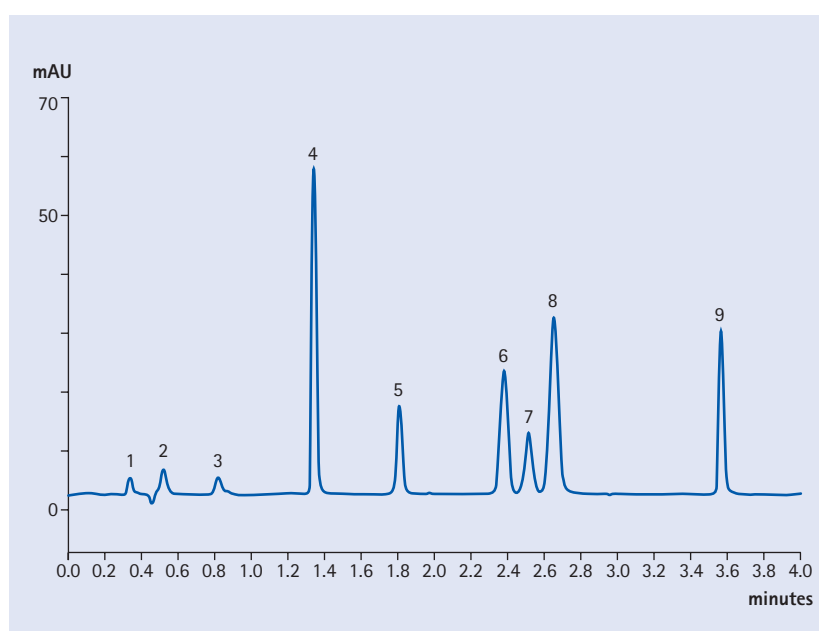

Purospher® STAR columns for LC-MS applications

"Ghost" mass peaks represent one problem frequently encountered in gradient LC-MS. It is impossible to differentiate whether these ghost peaks are originating from an unknown compound in the sample, from an impurity in the mobile phase or from bonded phase leaching.

To solve the problem of spurious LC-MS peaks, a three-step procedure is proposed for consistently running of ghost-peak-free HPLC. It includes cleaning the columns and choosing appropriate solvents for LC-MS applications, thus increasing ionization efficiency. Hence, both sensitivity and reproducibility of LC-MS results are improved.

A simple, easy to follow 3-step process optimizes performance in LC-MS

1. Flush the column for 60 minutes with a special solvent mixture to remove possible trace impurities. The recommended LC-MS wash solvent is 2-propanol with 0.1 % formic acid at a flow rate of 0.5 mL/min (for 3 mm i.d. columns).
2. To reduce the LC-MS background signal, work with extremely highly purified solvents. The recommended solvent is LiChrosolv® hypergrade with special MS specifications.
3. Finally, the column must be re-equilibrated with the mobile phase. Best results are obtained when two blank solvent gradients (without sample injection) are run prior to analysis. Purospher® STAR RP-18 end-capped HPLC columns give ideally low and very stable background signals in LC-MS, **simply after washing with 2-propanol / 0.1 % formic acid.**

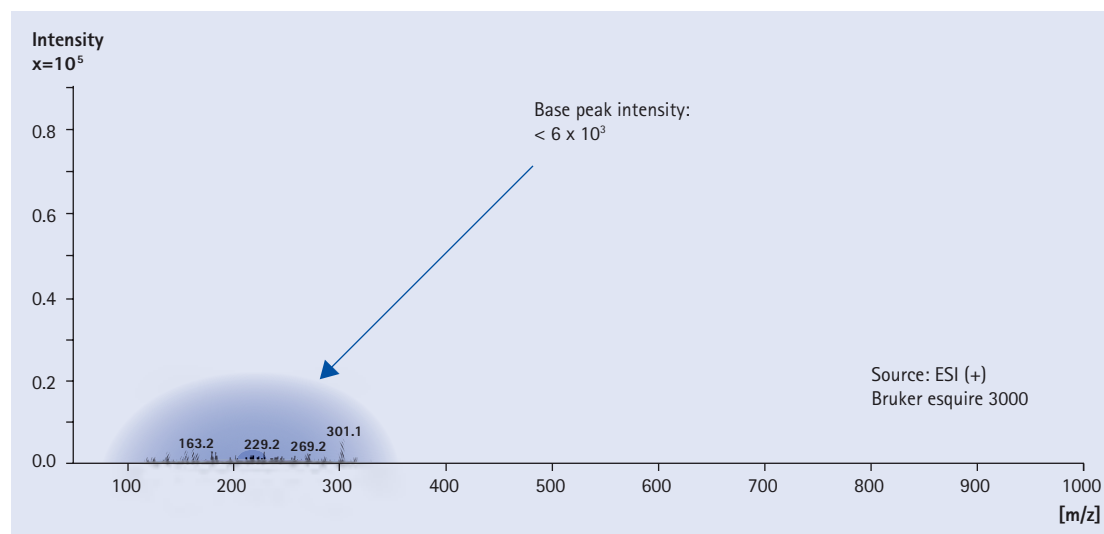

Purospher® STAR columns for LC-MS applications

Extracted ion chromatograms of "profens" in negative ion mode separated on Purospher® STAR RP-18 endcapped

Chromatographic conditions

Column	Purospher® STAR RP-18 endcapped, 3 µm LiChroCART® 55-2	
Mobile phase	A: 0.1 % Acetic acid in Acetonitrile B: 0.1 % Acetic acid in Water	
Gradient	From 25 % A to 50 % A in 3 min, then isocratic	
Flow rate	300 µL, without split	
Detection	UV 220 nm, Ion Trap MS	
Temperature	ambient	
Inj. volume	1 µL	
Sample	1. Ketoprofen	0.1 µg/µL
	2. Fenoprofen	0.1 µg/µL
	3. Ibuprofen	0.1 µg/µL

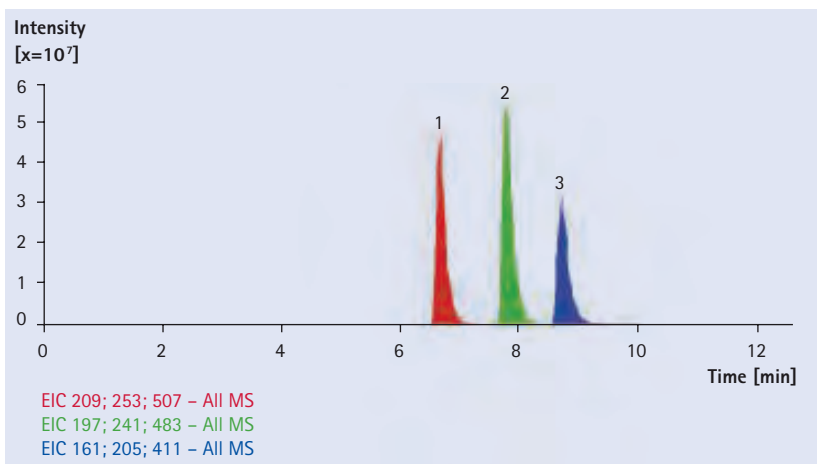

MS conditions

Ionization	ESI(-)
Nebulizer	36 psi
Dry gas	8.5 L/min
Dry temperature	330°C
Smart mode optimization	Target mass 205
Ion charge control	Target 50,000, max 50 ms
Scan mode	Standard/Normal
Scan range	50-600 m/z

Ketoprofen, Fenoprofen and Ibuprofen (100 ng) give ghost-peak-free MS spectra using LiChrosolv® Acetonitrile hypergrade and Purospher® STAR RP-18 endcapped columns.

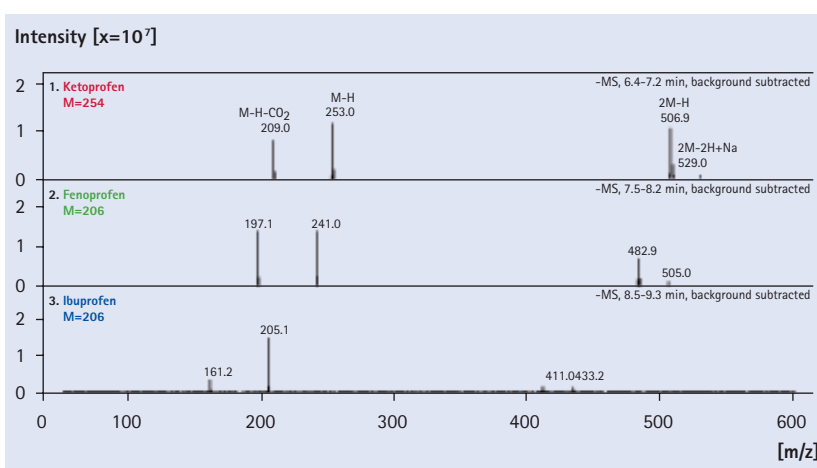

Best choice for UHPLC-MS – Purospher® STAR UHPLC columns

Purospher® STAR RP-18 endcapped columns fulfill all requirements for fast, modern UHPLC-MS analysis. Identification and quantification of Buprenorphine and its metabolites can be done in just a few minutes. The analysis time for Buprenorphine is 1.4 minutes.

Quantification of Buprenorphine and Norbuprenorphine with UHPLC-MS/MS

Buprenorphine is a synthetic derivative of the alkaloid thebaine and has partial agonistic properties at the opiate receptor. It is used for pain treatment and aversion therapy for heroin dependence.

Buprenorphine

MS instrument	Sciex API4000		
UHPLC Column	Purospher® STAR RP-18 endcapped, 2 µm Hibar® HR 50-2.1 mm		
Mobile phase	A. 0.1 % formic acid in Milli-Q water B. 0.1 % formic acid in acetonitrile		
Gradient	Time [min]	A [%]	B [%]
	0.00	90	10
	0.25	90	10
	2.00	10	90
	2.10	90	10
	3.00	90	10
Flow rate	0.7 mL/min		
Mobile phase start	90/10 A/B		
Column back-pressure at start	230 bar		

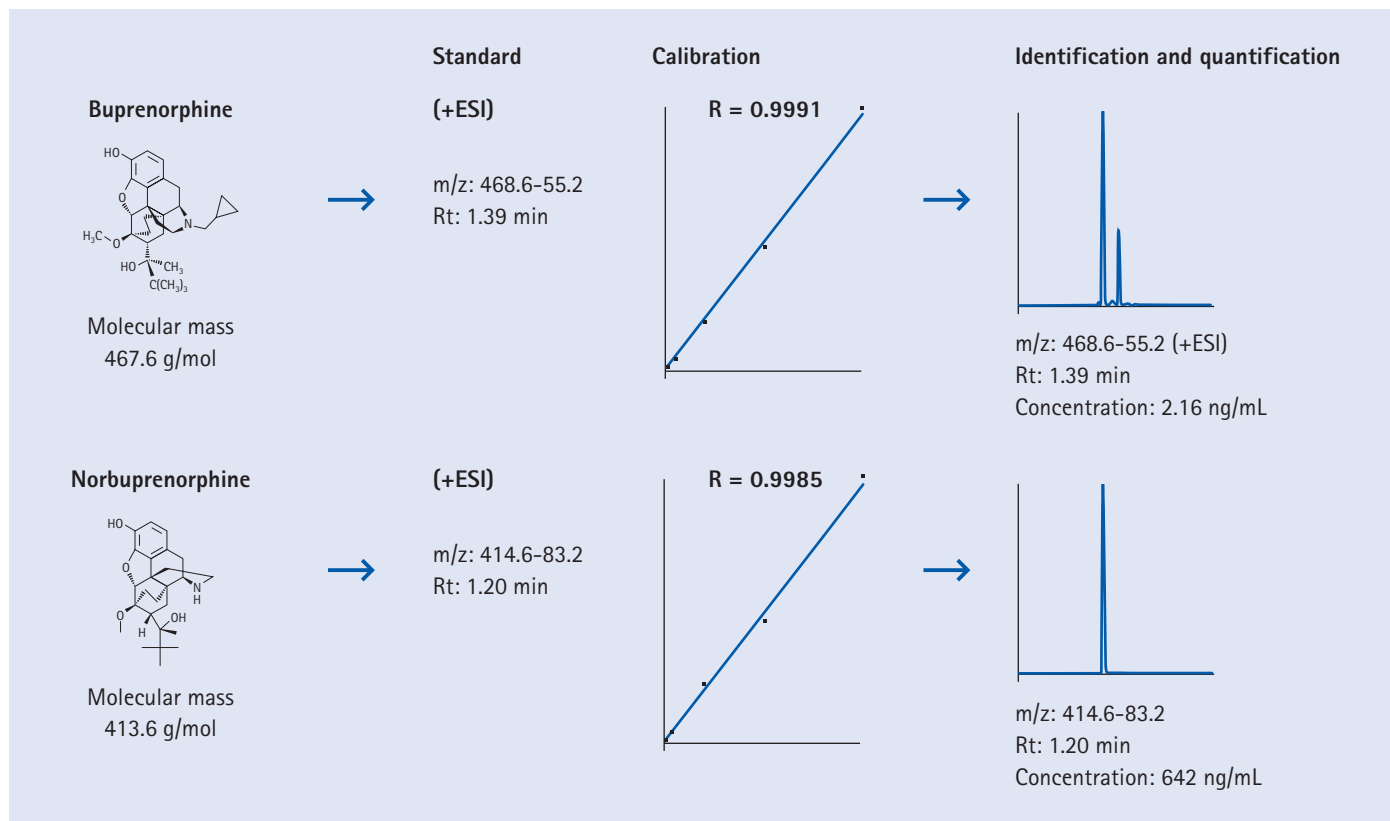

Purospher® RP-18 endcapped

Excellent peak symmetry with either basic or strongly acidic compounds

Purospher® RP-18 endcapped is a versatile HPLC column providing separations with excellent peak symmetry for both basic and strongly acidic compounds. Simply composed eluents can be employed for the separation of basic drugs. This results in shorter analysis time and increases laboratory productivity. The excellent balance of chromatographic properties is the key for better separating complex samples with simple, neutral eluents. Purospher® RP-18 endcapped is based upon a high purity, metal-free silica with a complete coverage of the silica surface with C18-ligands. This enables a peak-tailing free elution of acidic, basic, and chelating compounds. Key applications are the determination of various azo dyestuff amines and beta-blockers demonstrating the good resolution and high peak symmetry.

Additionally, the chemical stability of Purospher® RP-18 endcapped is high. Mobile phase conditions at pH 8 can be used for a long period of time without loss of performance. Purospher® RP-18 endcapped columns have excellent selectivity and column efficiency – allowing robust method development in R&D and QC.

Purospher® RP-18 endcapped benefits

- Excellent column selectivity for both basic and strongly acidic drugs
- Robust and fast method development with simple, neutral eluents

Specifications of Purospher® RP-18 endcapped

Sorbent characteristics	High-purity silica particles C18 with special modification and deactivation of the surface
Metal content	Na, Ca, Mg, Al: 1 ppm; Fe: 3 ppm
Particle shape	spherical
Particle size	5 µm
Pore size	9 nm (90 Å)
Pore volume	1.05 mL/g
Specific surface area	480 m ² /g
Carbon load	18.0 % C
Efficiency	80,000 N/m
pH range	pH 2 – 8
Shipping eluent	Acetonitrile/Water

Ordering information – Purospher® RP-18 endcapped, stainless steel cartridges LiChroCART®

Product	Ordering No.	Particle size	Dimension length	Dimension i.d.	Contents of one package
Purospher® RP-18 endcapped	1.50798.0001	5 µm	125 mm	3 mm	1 piece
Purospher® RP-18 endcapped	1.50799.0001	5 µm	125 mm	3 mm	3 pieces
Purospher® RP-18 endcapped	1.51384.0001	5 µm	250 mm	3 mm	1 piece
Purospher® RP-18 endcapped	1.50167.0001	5 µm	4 mm	4 mm	10 pieces
Purospher® RP-18 endcapped	1.50168.0001	5 µm	125 mm	4 mm	1 piece
Purospher® RP-18 endcapped	1.50169.0001	5 µm	250 mm	4 mm	1 piece
Purospher® RP-18 endcapped, custom packed	1.50013.7130	5 µm	100 mm	4.6 mm	1 piece

The LiChroCART® columns (75, 125, 150 and 250 mm length) in the list above (4 mm i.d.) require part number 1.51486.0001 manu-CART® cartridge column holder, which can be used to hold one cartridge column with or without a 4–4 mm guard column. Additional dimensions available as customized packings see page 366.

► **Purospher® STAR RP-18 endcapped**
The versatility you need!
page 269

► **Purospher® RP-18**
Polar endcapped column material
page 304

► **LiChrospher® 60 RP-select B** Excellent separations even with basic compounds
page 329

► **Aluspher®**
Alkaline stable HPLC separations
page 345

► **Customized packings**
Always the right column
page 366

Accessories for particulate HPLC columns:

► **manu-CART® cartridge holder** for LiChroCART® cartridges
page 370

► **LiChroCART® cartridge**
Different lengths, different internal diameter
page 373

Separation examples on Purospher® RP-18 endcapped

Amines from Azo Dyes

Column	Purospher® RP-18 endcapped, 5 µm LiChroCART® 125-4	
Mobile phase	A: Acetonitrile B: 20 mM Phosphate buffer pH 7.0 (H ₃ PO ₄ with ammonia)	
Gradient	0.0 – 19.9 min	25 % A
	19.9 – 20.0 min	28 – 60 % A
	20.0 – 30.0 min	60 % A
Flow rate	1.0 mL/min	
Detection	UV 254 nm	
Temperature	55°C	
Injection volume	10 µL	
Sample	<ol style="list-style-type: none"> 1. 2,4-Diaminoanisole 2. 2,4-Diaminotoluene 3. 4,4'-Oxydianiline 4. Benzidine 5. o-Toluidine 6. 4,4'-Diaminodiphenylmethane 7. p-Chloroaniline 8. p-Cresidine 9. 3,3'-Dimethoxybenzidine 10. 4,4'-Thiodianiline 11. 3,3'-Dimethylbenzidine 12. 2-Naphthylamine 13. 4-Chloro-o-toluidine 14. 2,4,5-Trimethylaniline 15. 4,4'-Diamino-3,3'-dimethyldiphenylmethane 16. 4-Aminobiphenyl 17. 3,3'-Dichlorobenzidine 18. 4,4'-Diamino-3,3'-dichlorodiphenylmethane 	

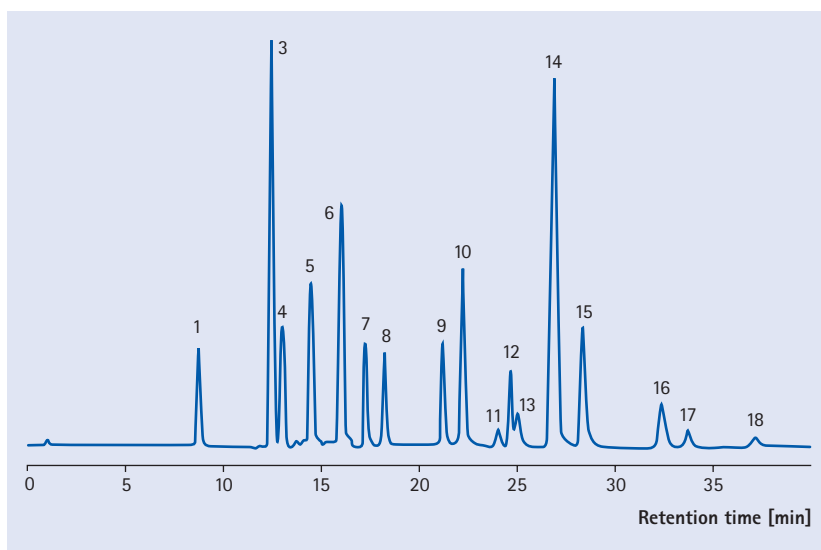

Beta-Blockers

Column	Purospher® RP-18 endcapped, 5 µm LiChroCART® 125-4	
Mobile phase	Methanol/0.05 M Phosphate buffer pH 3.0 45/55 (v/v)	
Flow rate	0.5 mL/min	
Detection	UV 265 nm	
Temperature	32°C	
Injection volume	2 µL	
Sample	<ol style="list-style-type: none"> 1. Practolol 2. Pafenolol 3. Metoprolol 4. Celiprolol 5. Carazolol 	<ol style="list-style-type: none"> 6. Bisoprolol 7. Metipranolol 8. Propanolol 9. Alprenolol 10. Carvedilol

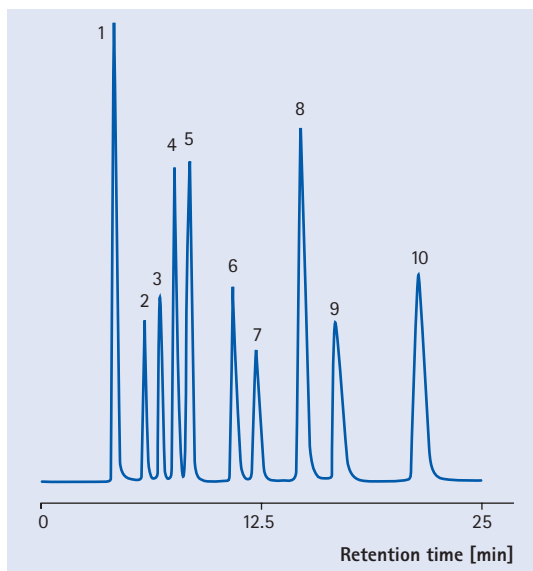

Purospher® RP-18

Polar endcapped column material

Purospher® RP-18 is designed for peak-tailing free chromatography of strongly basic compounds with simple, neutral mobile phases. Thus, method development time and consequently analyses costs are reduced. Additionally, Purospher® RP-18 allows the separation of hydrophilic compounds using up to 100 % aqueous eluents.

The key for understanding the properties of Purospher® RP-18 lies in the chemistry of the base, high purity silica with virtually no metal contaminants present. In addition, multi-step chemical modification and deactivation by polymeric coating and amino shielding of the surface eliminate unpredictable interactions from residual silanols. This results in symmetric peak shapes of basic and chelating analytes without the addition of any modifiers to the mobile phase. Due to the amino endcapping step, Purospher® RP-18 is not suitable for the separation of acidic compounds. The high chemical stability of Purospher® RP-18 permits the usage of mobile phase conditions at pH 8 for a long period of time without decline of performance.

Purospher® RP-18 benefits

- Symmetrical peaks for basic, chelating, and polar analytes
- Fast method development for basic compounds

Specifications of Purospher® RP-18

Sorbent characteristics	High-purity silica particles with C18 modification and deactivation of the surface; amino shielding not suitable for acidic compounds!
Particle shape	spherical
Particle size	5 µm
Pore size	9 nm (90 Å)
Pore volume	1.05 mL/g
Specific surface area	480 m ² /g
Carbon load	17 % C
Efficiency	80,000 N/m
pH range	pH 2 – 8
Shipping eluent	Acetonitrile/Water

Ordering information – Purospher® RP-18, stainless steel cartridges LiChroCART®

Product	Ordering No.	Particle size	Dimension length	Dimension i.d.	Contents of one package
Purospher® RP-18, custom packed	1.50175.7127	5 µm	125 mm	3 mm	1 piece
Purospher® RP-18, custom packed	1.50177.7127	5 µm	250 mm	3 mm	1 piece
Purospher® RP-18	1.50141.0001	5 µm	4 mm	4 mm	10 pieces
Purospher® RP-18, custom packed	1.50171.7127	5 µm	75 mm	4 mm	1 piece
Purospher® RP-18	1.50142.0001	5 µm	125 mm	4 mm	1 piece
Purospher® RP-18	1.50144.0001	5 µm	250 mm	4 mm	1 piece
Purospher® RP-18, custom packed	1.51431.7127	5 µm	250 mm	4.6 mm	1 piece
Purospher® RP-18, custom packed	1.50179.7127	5 µm	250 mm	10 mm	1 piece

The LiChroCART® columns (75, 125, 150 and 250 mm length) in the list above (4 mm i.d.) require part number 1.51486.0001 manu-CART® cartridge column holder, which can be used to hold one cartridge column with or without a 4–4 mm guard column. Additional dimensions available as customized packings see page 366.

► **Purospher® STAR RP-18 endcapped**
The versatility you need!
page 269

► **Purospher® RP-18 endcapped** Excellent peak symmetry with either basic or strongly acidic compounds
page 302

► **LiChrospher® 60 RP-select B** Excellent separations even with basic compounds
page 329

► **Aluspher®**
Alkaline stable HPLC separations
page 345

► **Customized packings**
Always the right column
page 366

Accessories for particulate HPLC columns:

► **manu-CART® cartridge holder** for LiChroCART® cartridges
page 370

► **LiChroCART® cartridge**
Different lengths, different internal diameter
page 373

Ordering information – Purospher® STAR RP18, stainless steel columns Hibar® RT

Product	Ordering No.	Particle size	Dimension length	Dimension i.d.	Contents of one package
Purospher® RP-18, custom packed	1.50012.7127	5 µm	125 mm	4.6 mm	1 piece
Purospher® RP-18, custom packed	1.50009.7127	5 µm	150 mm	4.6 mm	1 piece
Purospher® RP-18, custom packed	1.00424.7127	5 µm	250 mm	4.6 mm	1 piece
Purospher® RP-18, custom packed	1.50183.7127	5 µm	250 mm	10 mm	1 piece

The Hibar® RT columns are complete with endfittings. When using a guard column with a Hibar® RT column, we recommend part number 1.51487.0001 guard column cartridge holder for 4–4 mm guard column cartridges LiChroCART®. Additional dimensions available as customized packings see page 366.

Separation examples on Purospher® RP-18
Toluidines

Column	Purospher® RP-18, 5 µm LiChroCART® 125-4
Mobile phase	Acetonitrile/Water 30/70 (v/v)
Flow rate	1.0 mL/min
Detection	UV 254 nm
Temperature	Room temperature
Injection volume	10 µL
Sample	1. Caffeine 2. Aniline 3. Pyridine 4. o-Toluidine 5. m-Toluidine 6. p-Toluidine 7. N-Methylaniline 8. 2-Ethylaniline 9. 3-Nitroanisole 10. N,N-Dimethylaniline

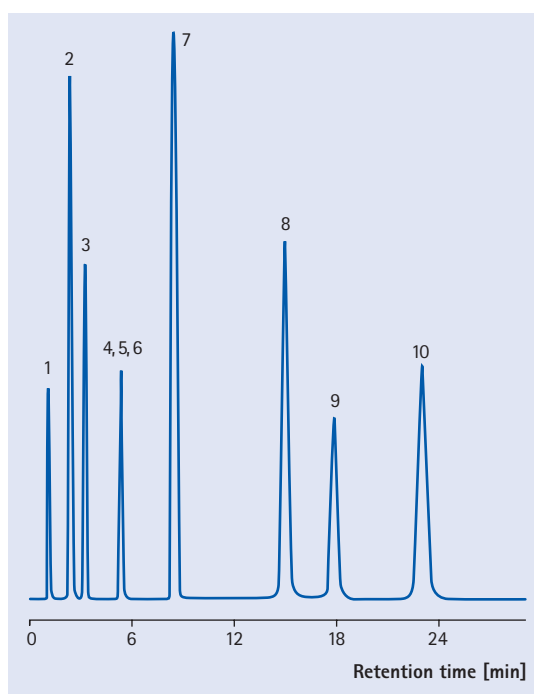

Purospher® RP-18 HC

High resolution separation of explosives and related compounds

Purospher® RP-18 HC is a non-encapped stationary phase providing high resolution for the separation of explosives and related compounds.

The determination of traces of explosives in soil and water samples in combination with solid-phase extraction is of great importance for scenarios like hazardous waste site characterization. With this HPLC column, also microbial transformation products of TNT (2-amino-4,6-dinitrotoluene [2-Am-DNT] and 4-amino-2,6-dinitrotoluene [4-Am-DNT]) and manufacturing impurities of TNT (2,4-DNT, 2,6-DNT, and 1,3-DNB) could easily be separated from each other. Purospher® RP-18 HC is also suitable for the separation of picric acid from hexyl and ethylene glycol dinitrate (EGDN) from diethylene glycol nitrate (DEGN).

Purospher® RP-18 HC benefits

- Separation of polar, non-basic analytes
- Traces determination of explosives



Specifications of Purospher® RP-18 HC

Sorbent characteristics	High-purity silica particles with dedicated RP-18 modification
Particle shape	spherical
Particle size	5 µm
Pore size	9 nm (90 Å)
Pore volume	1.05 mL/g
Specific surface area	470 m ² /g
Carbon load	18 % C
pH range	pH 2 – 8
Shipping eluent	Acetonitrile/Water

Ordering information – Purospher® RP-18 HC, stainless steel cartridges LiChroCART®

Product	Ordering No.	Particle size	Dimension length	Dimension i.d.	Contents of one package
Purospher® RP-18 HC, custom packed	1.50171.7131	5 µm	75 mm	4 mm	1 piece
Purospher® RP-18 HC, custom packed	1.50170.7131	5 µm	125 mm	4 mm	1 piece
Purospher® RP-18 HC	1.51436.0001	5 µm	250 mm	4 mm	1 piece

The LiChroCART® columns (75, 125, 150 and 250 mm length) in the list above (4 mm i.d.) require part number 1.51486.0001 manu-CART® cartridge column holder, which can be used to hold one cartridge column with or without a 4-4 mm guard column. Additional dimensions available as customized packings see page 366.

► Purospher® STAR RP-18 endcapped
The versatility you need!
page 269

► Purospher® STAR RP-8 endcapped
Ideal for less hydrophobic compounds
page 283

► Purospher® STAR Si (Silica) and NH₂ (Amino-phase)
page 289

► LiChrospher® 60 RP-select B
Excellent separations even with basic compounds
page 329

► Aluspher®
Alkaline stable HPLC separations
page 345

► Customized packings
Always the right column
page 366

Accessories for particulate HPLC columns:

► manu-CART® cartridge holder for LiChroCART® cartridges
page 370

► LiChroCART® cartridge
Different lengths, different internal diameter
page 373

Separation examples on Purospher® RP-18 HC

Separation of explosives from drinking water

Column	Purospher® RP-18 HC, 5 µm LiChroCART® 250-4	
Mobile phase	A: Acetonitrile / Methanol; 20 / 80, v/v B: Sodium dihydrogenphosphate buffer (c = 0.01 mol/L, pH 4.5)	
Gradient	0 min 35 % A; 28 min 55 % A; 40 min 85 % A; 50 min 85 % A; 51 min 35 % A; 71 min 35 % A	
Flow rate	0.8 mL/min	
Detection	DAD 210 and 235 nm	
Temperature	36°C	
Injection volume	40 µL	
Sample	No 1.-19.	Recovery
	1. Octogen (HMX)	105 %
	2. Picric acid	96 %
	3. Hexogen (RDX)	107 %
	4. Ethylene glycol dinitrate (EGDN)	61 %
	5. Dethylene glycol dinitrate (DEGN)	95 %
	6. 1,3,5-Trinitrobenzene	102 %
	7. 1,3-Dinitrobenzene	96 %
	8. Tetryl	91 %
	9. Nitroglycerine	53 %
	10. 2,4,6-Trinitrotoluene	99 %
	11. 4-Amino-2,6-dinitrotoluene	106 %
	12. 2-Amino-4,6-dinitrotoluene	107 %
	13. 2,6-Dinitrotoluene	104 %
	14. 2,4-Dinitrotoluene	104 %
	15. 2-Nitrotoluene	85 %
	16. 4-Nitrotoluene	88 %
	17. 3-Nitrotoluene	86 %
	18. Nitropenta (PETN)	106 %
	19. Hexyl	73 %

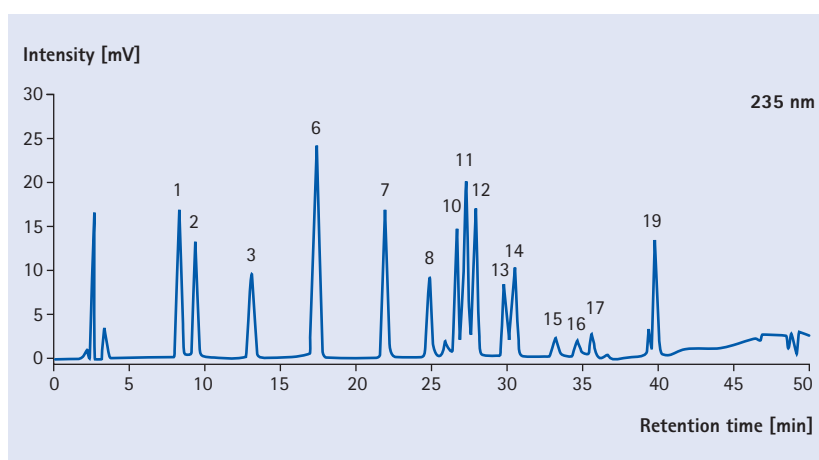
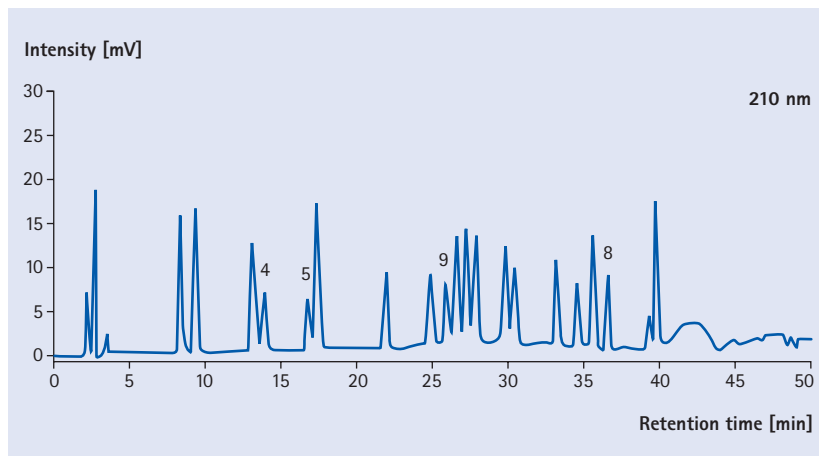

Sample preparation

Solid phase extraction	LiChrolut® EN (200 mg) [Cat. No. 119870]
Solvents	A: Methanol [LiChrosolv® Cat. No. 106007] B: Acetonitrile [LiChrosolv® Cat. No. 100030] C: Water [LiChrosolv® Cat. No. 115333]
Initial sample preparation	Filtrate if necessary and add approx. 5 g NaCl/L water sample.
Conditioning of extraction column	3 mL A 3 mL B 10 mL C
	Do not allow column to dry out!

Sample application	Pass 1 L water sample through the extraction column within 1 hour by using LiChrolut® extraction unit [Cat. No. 119851] which is connected to the water sample with PTFE hose [Cat. No. 122143] and a steel capillary [Cat. No. 119902]. The PTFE hose is placed through the adapter [Cat. No. 102206] which is plugged into the column.
Drying step	10 min by means of nitrogen and LiChrolut® drying unit [Cat. No. 119852].
Elution step	1 x 2 mL, then 1 x 3 mL A/B (1:1), collect in a conical flask and gently evaporate the solvent by means of nitrogen up to a volume of 0.5 mL. Fill up to 1.0 mL with C. Subsequently filtrate sample into a 1.5 mL sample vial [Cat. No. 118081] through a 0.2 µm anotop membrane filter [Cat. No. 111318].

Analytical HPLC

Superspher[®]

Silica carrier for highly efficient separations

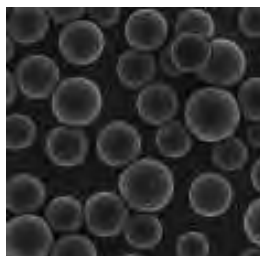

Superspher[®], a high-performance spherical silica carrier with a mean particle size of 4 μm , provides an excellent pressure/separation performance ratio in terms of today's generation of HPLC systems. The number of theoretical plates for Superspher[®] is approx. 100,000 N/m. Thus, Superspher[®] columns are always the first choice when complex mixtures demand high peak capacity. **A broad range of modifications on Superspher[®] is available: non-polar derivatives (RP-8, RP-8 endcapped, RP-18, RP-18 endcapped and RP-select B) and polar derivatives (Si 60).**

Superspher[®] packing materials are available as LiChroCART[®] cartridges in various lengths and internal diameters (4.6 mm, 4 mm, 3.9 mm, 3 mm and 2 mm). LiChroCART[®] 3 mm i.d. and 2 mm i.d. narrow bore cartridges for HPLC save costs by reducing solvent consumption and allow the handling of very small quantities with excellent sensitivity and resolution. LiChroCART[®] cartridges 4.6 mm, 4 mm i.d., 3.9 mm i.d., 3 mm i.d. and 2 mm i.d. are compatible with manu-CART[®] "4". This facilitates faster and more flexible method adaptation to smaller bore columns.

Specifications of Superspher[®]

Packing material	Characteristics	Spec. surface area S_{BET} [m^2/g]	Pore volume V_p [mL/g]	Particle size d_p [μm]	% C	Surface coverage [$\mu\text{mol/m}^2$]
Superspher [®] Si 60	spherical particles of silica medium pore size: 6 nm (60 Å)	700	0.85	4	–	–
Superspher [®] 60 RP-8	spherical particles of silica with octyl derivative	350	1.25	4	12.5	4.04
Superspher [®] 60 RP-8 endcapped	spherical particles of silica with octyl derivative endcapped	350	1.25	4	13.0	4.44
Superspher [®] 100 RP-18	spherical particles of silica with octadecyl derivative	350	1.25	4	21.0	3.61
Superspher [®] 100 RP-18 endcapped	spherical particles of silica with octadecyl derivative endcapped	350	1.25	4	21.6	4.09
Superspher [®] 60 RP-select B	spherical particles of silica with octyl derivative, especially suitable for the RP-separation of basic compounds	360	0.9	4	11.5	3.55

Superspher®

For highly efficient HPLC of complex mixtures
where high peak capacity is required

Ordering information – Superspher® sorbents

Product	Ordering No.	Particle size	Package	Quantity
Superspher® 60 RP-8	1.19612.0010	4 µm	Glass	10 g
Superspher® 60 RP-select B	1.19643.0010	4 µm	Glass	10 g
Superspher® 100 RP-18	1.19613.0010	4 µm	Glass	10 g
Superspher® 100 RP-18 endcapped	1.19618.0010	4 µm	Glass	10 g



Ordering information – Superspher®, stainless steel columns Hibar®

Product	Ordering No.	Particle size	Dimension length	Dimension i.d.	Contents of one package
Superspher® 60 RP-8	1.50012.7139	4 µm	125 mm	4.6 mm	1 piece
Superspher® 60 RP-8 endcapped	1.50181.7140	4 µm	125 mm	4 mm	1 piece
Superspher® 60 RP-8 endcapped	1.50012.7140	4 µm	125 mm	4.6 mm	1 piece
Superspher® 60 RP-select B	1.50181.7141	4 µm	125 mm	4 mm	1 piece
Superspher® 60 RP-select B	1.50182.7141	4 µm	250 mm	4 mm	1 piece
Superspher® 60 RP-select B	1.50009.7141	4 µm	150 mm	4.6 mm	1 piece
Superspher® 100 RP-18	1.00423.7137	4 µm	250 mm	3 mm	1 piece
Superspher® 100 RP-18	1.50182.7137	4 µm	250 mm	4 mm	1 piece
Superspher® 100 RP-18	1.50012.7137	4 µm	125 mm	4.6 mm	1 piece
Superspher® 100 RP-18	1.50009.7137	4 µm	150 mm	4.6 mm	1 piece
Superspher® 100 RP-18	1.00424.7137	4 µm	250 mm	4.6 mm	1 piece
Superspher® 100 RP-18 endcapped	1.50182.7138	4 µm	250 mm	4 mm	1 piece
Superspher® 100 RP-18 endcapped	1.50013.7138	4 µm	100 mm	4.6 mm	1 piece
Superspher® 100 RP-18 endcapped	1.50012.7138	4 µm	125 mm	4.6 mm	1 piece
Superspher® 100 RP-18 endcapped	1.50009.7138	4 µm	150 mm	4.6 mm	1 piece

The Hibar® columns are complete with endfittings. When using a guard column with a Hibar® column, we recommend part number 1.51487.0001 guard column cartridge holder for 4–4 mm guard column cartridges LiChroCART®. Additional dimensions available as customized packings see page 366.

► Customized packings
Always the right column
page 366

Accessories for particulate HPLC columns:

► manu-CART® cartridge holder for LiChroCART® cartridges
page 370

► LiChroCART® cartridge
Different lengths, different internal diameter
page 373

Ordering information – Superspher®, stainless steel cartridges LiChroCART®

Product	Ordering No.	Particle size	Dimension length	Dimension i.d.	Contents of one package
Superspher® Si 60	1.16054.0001	4 µm	125 mm	4 mm	1 piece
Superspher® Si 60	1.16009.0001	4 µm	250 mm	4 mm	1 piece
Superspher® 60 RP-8	1.50195.7139	4 µm	125 mm	2 mm	1 piece
Superspher® 60 RP-8	1.50177.7139	4 µm	250 mm	3 mm	1 piece
Superspher® 60 RP-8	1.50228.7139	4 µm	55 mm	4 mm	1 piece
Superspher® 60 RP-8	1.16052.0001	4 µm	125 mm	4 mm	1 piece
Superspher® 60 RP-8 (3 HPLC columns from 3 batches)	1.16052.1003	4 µm	125 mm	4 mm	3 pieces
Superspher® 60 RP-8	1.16010.0001	4 µm	250 mm	4 mm	1 piece
Superspher® 60 RP-8 (3 HPLC columns from 3 batches)	1.16010.1003	4 µm	250 mm	4 mm	3 pieces
Superspher® 60 RP-8 endcapped	1.50195.7140	4 µm	125 mm	2 mm	1 piece
Superspher® 60 RP-8 endcapped	1.16854.0001	4 µm	125 mm	4 mm	1 piece
Superspher® 60 RP-8 endcapped	1.16857.0001	4 µm	250 mm	4 mm	1 piece
Superspher® 60 RP-select B	1.50205.0001	4 µm	10 mm	2 mm	3 pieces
Superspher® 60 RP-select B	1.50197.0001	4 µm	125 mm	2 mm	1 piece
Superspher® 60 RP-select B	1.51308.0001	4 µm	250 mm	2 mm	1 piece
Superspher® 60 RP-select B	1.50233.7141	4 µm	30 mm	3 mm	1 piece
Superspher® 60 RP-select B	1.50791.0001	4 µm	125 mm	3 mm	1 piece
Superspher® 60 RP-select B	1.51288.0001	4 µm	250 mm	3 mm	1 piece
Superspher® 60 RP-select B	1.50974.0001	4 µm	75 mm	4 mm	3 pieces
Superspher® 60 RP-select B	1.50975.0001	4 µm	125 mm	4 mm	1 piece
Superspher® 60 RP-select B	1.50973.0001	4 µm	250 mm	4 mm	1 piece
Superspher® 60 RP-select B	1.51432.7141	4 µm	150 mm	4.6 mm	1 piece
Superspher® 60 RP-select B	1.51431.7141	4 µm	250 mm	4.6 mm	1 piece
Superspher® 60 RP-select B	1.51444.7141	4 µm	150 mm	10 mm	1 piece

The LiChroCART® columns (75, 125, 150 and 250 mm length) in the list on the left (2, 3, 4 and 4.6 mm i.d.) require part number 1.51486.0001 manu-CART® cartridge column holder, which can be used to hold one cartridge column with or without a 4–4 mm guard column. Additional dimensions available as customized packings see page 366. As guard column we recommend LiChroCART® 4–4 LiChrospher® guard cartridges.



Ordering information – Superspher®, stainless steel cartridges LiChroCART®

Product	Ordering No.	Particle size	Dimension length	Dimension i.d.	Contents of one package
Superspher® 100 RP-18	1.50204.0001	4 µm	10 mm	2 mm	3 pieces
Superspher® 100 RP-18	1.50200.0001	4 µm	125 mm	2 mm	1 piece
Superspher® 100 RP-18 (3 HPLC columns from 3 batches)	1.50200.1003	4 µm	125 mm	2 mm	3 pieces
Superspher® 100 RP-18	1.50190.7137	4 µm	250 mm	2 mm	1 piece
Superspher® 100 RP-18	1.50792.0001	4 µm	125 mm	3 mm	1 piece
Superspher® 100 RP-18 (3 HPLC columns from 3 batches)	1.50792.1003	4 µm	125 mm	3 mm	3 pieces
Superspher® 100 RP-18	1.51299.0001	4 µm	250 mm	3 mm	1 piece
Superspher® 100 RP-18 (3 HPLC columns from 3 batches)	1.51299.1003	4 µm	250 mm	3 mm	3 pieces
Superspher® 100 RP-18	1.16039.0001	4 µm	25 mm	4 mm	3 pieces
Superspher® 100 RP-18	1.50980.0001	4 µm	75 mm	4 mm	3 pieces
Superspher® 100 RP-18	1.16051.0001	4 µm	125 mm	4 mm	1 piece
Superspher® 100 RP-18 (3 HPLC columns from 3 batches)	1.16051.1003	4 µm	125 mm	4 mm	3 pieces
Superspher® 100 RP-18	1.16056.0001	4 µm	250 mm	4 mm	1 piece
Superspher® 100 RP-18 (3 HPLC columns from 3 batches)	1.16056.1003	4 µm	250 mm	4 mm	3 pieces
Superspher® 100 RP-18 endcapped	1.50198.0001	4 µm	125 mm	2 mm	1 piece
Superspher® 100 RP-18 endcapped	1.50193.0001	4 µm	250 mm	2 mm	1 piece
Superspher® 100 RP-18 endcapped	1.51909.0001	4 µm	125 mm	3 mm	1 piece
Superspher® 100 RP-18 endcapped	1.51910.0001	4 µm	250 mm	3 mm	1 piece
Superspher® 100 RP-18 endcapped	1.16869.0001	4 µm	25 mm	4 mm	3 pieces
Superspher® 100 RP-18 endcapped	1.50302.7138	4 µm	30 mm	4 mm	1 piece
Superspher® 100 RP-18 endcapped	1.16855.0001	4 µm	125 mm	4 mm	1 piece
Superspher® 100 RP-18 endcapped	1.16858.0001	4 µm	250 mm	4 mm	1 piece
Superspher® 100 RP-18 endcapped	1.51448.7138	4 µm	100 mm	4.6 mm	1 piece
Superspher® 100 RP-18 endcapped	1.51442.7138	4 µm	125 mm	4.6 mm	1 piece
Superspher® 100 RP-18 endcapped	1.51432.7138	4 µm	150 mm	4.6 mm	1 piece
Superspher® 100 RP-18 endcapped	1.51431.7138	4 µm	250 mm	4.6 mm	1 piece

The LiChroCART® columns (75, 125, 150 and 250 mm length) in the list on the left (2, 3, 4 and 4.6 mm i.d.) require part number 1.51486.0001 manu-CART® cartridge column holder, which can be used to hold one cartridge column with or without a 4–4 mm guard column. Additional dimensions available as customized packings see page 366. As guard column we recommend LiChroCART® 4–4 LiChrospher® guard cartridges.

LiChrospher®

Silica carrier for constant top-rate results

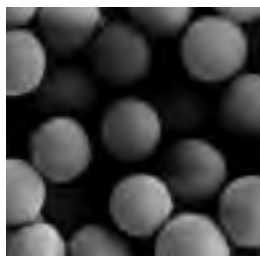

LiChrospher® is the name given to reliable and versatile traditionally produced spherical silica carriers. LiChrospher® silica carriers are available in a number of different modifications. The polar modified phases LiChrospher® CN, LiChrospher® NH₂ and LiChrospher® DIOL as well as LiChrospher® Si with no modification are best for normal-phase HPLC. The non-polar modified phases LiChrospher® RP-8, RP-8 endcapped, RP-select B, RP-18, RP-18 endcapped are made for reversed-phase separations. Furthermore, LiChrospher® PAH is highly efficient and selective for the separation of PAH, as well as LiChrospher® WP 300 RP-18 for the separation of peptides and low molecular weight proteins.

LiChrospher® packing materials are available as Hibar® RT columns and as LiChroCART® cartridges of various lengths and internal diameters (10 mm, 4.6 mm, 4 mm, 3 mm and 2 mm). LiChroCART® 3 mm i.d. and 2 mm i.d. narrow bore cartridges for HPLC save costs by reducing solvent consumption and allow the handling of very small quantities with excellent sensitivity and resolution. LiChroCART® cartridges 4.6 mm, 4 mm i.d., 3.9 mm i.d., 3 mm i.d. and 2 mm i.d. are compatible with manu-CART® "4". This facilitates faster and more flexible method adaptation to smaller bore columns. LiChroCART® cartridges 10 mm i.d. have to be used with manu-CART® "10".

Specifications of LiChrospher® packing materials

Packing material	Characteristics	Spec. surface area S _{BET} [m ² /g]	Pore volume V _p [mL/g]	Particle size d _p [μm]	% C	Surface coverage [μmol/m ²]
LiChrospher® Si 60	spherical particles of silica medium pore size: 6 nm (60 Å)	700	0.85	5, 10	–	–
LiChrospher® Si 100	spherical particles of silica medium pore size: 10 nm (100 Å)	400	1.25	5, 10	–	–
LiChrospher® 100 CN	spherical particles of silica with cyanopropyl function	350	1.25	5, 10	6.6	3.52
LiChrospher® 100 NH ₂	spherical particles of silica with aminopropyl function	350	1.25	5, 10	4.6	4.10
LiChrospher® 100 DIOL	spherical particles of silica with vicinal hydroxyl function on C-chains	350	1.25	5, 10	8.0	3.87
LiChrospher® 100 RP-8	spherical particles of silica with octyl derivative	350	1.25	5, 10	12.5	4.04
LiChrospher® 100 RP-8 endcapped	spherical particles of silica with octyl derivative endcapped	350	1.25	5, 10	13.0	4.44
LiChrospher® 100 RP-18	spherical particles of silica with octadecyl derivative	350	1.25	5, 7, 10	21.0	3.61
LiChrospher® 100 RP-18 endcapped	spherical particles of silica with octadecyl derivative endcapped	350	1.25	5, 10	21.6	4.09
LiChrospher® 60 RP-select B	spherical particles of silica with octyl derivative, especially suitable for the RP separation of basic compounds	350	0.9	5, 10	11.5	3.55
LiChrospher® WP 300 RP-18	spherical particles of silica with octadecyl derivative	80	1.0	5, 12, 15	–	–

Fraction range of LiChrospher® packing materials

Product	Spec. pore volume [mL/g]	Spec. surface area [m ² /g]	Fractionation range (Polystyrene/THF) [g/mol]
LiChrospher® Si 60	0.85	700	100 – 2 · 10 ⁴
LiChrospher® Si 100	1.25	400	200 – 7 · 10 ⁴
LiChrospher® 100 DIOL	1.25	350	200 – 4 · 10 ⁴
LiChrospher® 100 RP-18	1.25	350	200 – 4 · 10 ⁴
LiChrospher® WP 300 RP-18	1.0	80	4000 – 6 · 10 ⁵

Certified reproducibility of HPLC separations

The heart of each HPLC system is the column, where the separation of sample components takes place. Due to the chemical properties of silica, HPLC columns are subject to natural wear, e.g. due to the irreversible adsorption of injected samples or sample matrix or due to mechanical and chemical instabilities of the stationary phase. As a consequence, altered selectivities, "ghost peaks", diminished separation power or excessively elevated column pressures will result, preventing further column use. Hence, changing HPLC columns is a permanent process. This need not necessarily be problematic if the new column is one of the same type and has the same properties as the preceding one. The certified reproducibility of HPLC columns makes extensive method revision unnecessary and does away with additional costs.

Separation performance, selectivity and capacity

Reproducibility is the most important property of an HPLC column, independent of the respective production batch. All columns of the same type should be reproducible and therefore comparable in terms of separation performance, selectivity and retention behaviour. In its determination, a characteristic substance mixture is subjected to chromatography under buffered elution conditions. The resulting chromatographic parameters such as k-values, separation factors and the minimum number of theoretical plates are fixed.

- Retention factor k (previously designated as capacity factor k') of a neutral compound means: the defined hydrophobic character of the stationary phase.
- Separation factors α (i.e. relative retention times, previously designated as selectivity) bring about a defined order of elution and defined peak distance from batch to batch and cartridge to cartridge.
- Minimum number of theoretical plates (N) under buffered (not ideal) chromatographic conditions ensures separation performance.

Certified reproducibility of HPLC columns – no additional costs in method evaluation

The evaluation of quality control methods for certain products, e.g. in the pharmaceutical sector, constitutes a considerable cost factor. The fact that an analytical method once established is used in expensive registration procedures for many years (up to 10 and more) requires thorough and careful elaboration. In this context, the selection of the HPLC column is an important decision criterion. The column certificate places the highest demands on process control during the batch-to-batch production of column materials. This ensures the customer constant HPLC column quality over many years. Therefore, no additional costs will arise for the revision or re-registration of a particular analysis method.

LiChrospher® 100 RP-18 and RP-18 endcapped

LiChrospher® 100 RP-18 and LiChrospher® 100 RP-18 endcapped are reliable and versatile traditionally produced spherical silica carriers with reversed-phase properties. They are well suited for the chromatography of acidic, neutral and weakly basic compounds, substances found frequently in all analytical fields.

For LiChrospher® RP-18, a masterbatch concept, where several individual batches are used to produce a large batch ("the masterbatch") of the LiChrospher® RP-18 sorbent, is applied with the aim of eliminating the variation between the individual batches.

Specifications of LiChrospher® 100 RP-18 and RP-18 endcapped

	LiChrospher® 100 RP-18	LiChrospher® 100 RP-18 endcapped
Sorbent characteristics	Particles of silica with octadecyl derivative	Particles of silica with octadecyl derivative endcapped
Particle shape	spherical	spherical
Particle size	5; 10 µm	5; 10 µm
Pore size	100 Å (nm)	100 Å (nm)
Pore volume	1.25 mL/g	1.25 mL/g
Specific surface area	350 m ² /g	350 m ² /g
Carbon load	21.0 % C	21.6 % C
Coverage of the surface	3.61 µmol/m ²	4.09 µmol/m ²
Efficiency	55,000 N/m; 20,000 N/m	55,000 N/m; 20,000 N/m
pH range	pH 2-7.5	pH 2-7.5
Shipping eluent	Acetonitrile/Water	Acetonitrile/Water

Ordering information – LiChrospher® 100 RP-18 and RP-18 endcapped sorbents

Product	Ordering No.	Particle size	Package	Quantity
LiChrospher® 100 RP-18	1.16177.0010	5 µm	Glass	10 g
LiChrospher® 100 RP-18	1.16105.0010	10 µm	Glass	10 g
LiChrospher® 100 RP-18 endcapped	1.19637.0010	5 µm	Glass	10 g
LiChrospher® 100 RP-18 endcapped	1.19633.0010	10 µm	Glass	10 g

► **Purospher® STAR RP-8 endcapped** Ideal for less hydrophobic compounds
page 283

► **Purospher® RP-18 endcapped** Excellent peak symmetry with either basic or strongly acidic compounds
page 302

► **Purospher® RP-18** Polar endcapped column material
page 304

► **Superspher®** Silica carrier for highly efficient separations
page 308

► **LiChrospher®** Silica carrier for constant top-rate results
page 312

► **LiChrosorb®** Irregular shaped silica sorbent
page 342

► **Customized packings** Always the right column
page 366

Accessories for particulate HPLC columns:

► **manu-CART® cartridge holder** for LiChroCART® cartridges
page 370

► **LiChroCART® cartridge** Different lengths, different internal diameter
page 373

Ordering information – LiChrospher® 100 RP-18, stainless steel columns Hibar®

Product	Ordering No.	Particle size	Dimension length	Dimension i.d.	Contents of one package
LiChrospher® 100 RP-18	1.00423.7079	5 µm	250 mm	3 mm	1 piece
LiChrospher® 100 RP-18	1.50477.0001	5 µm	125 mm	4 mm	1 piece
LiChrospher® 100 RP-18 (3 HPLC columns from 3 batches)	1.50477.1003	5 µm	125 mm	4 mm	3 pieces
LiChrospher® 100 RP-18	1.50377.0001	5 µm	250 mm	4 mm	1 piece
LiChrospher® 100 RP-18 (3 HPLC columns from 3 batches)	1.50377.1003	5 µm	250 mm	4 mm	3 pieces
LiChrospher® 100 RP-18	1.50545.0001	5 µm	100 mm	4.6 mm	1 piece
LiChrospher® 100 RP-18 (3 HPLC columns from 3 batches)	1.50545.1003	5 µm	100 mm	4.6 mm	3 pieces
LiChrospher® 100 RP-18	1.50546.0001	5 µm	150 mm	4.6 mm	1 piece
LiChrospher® 100 RP-18 (3 HPLC columns from 3 batches)	1.50546.1003	5 µm	150 mm	4.6 mm	3 pieces
LiChrospher® 100 RP-18	1.50547.0001	5 µm	250 mm	4.6 mm	1 piece
LiChrospher® 100 RP-18 (3 HPLC columns from 3 batches)	1.50547.1003	5 µm	250 mm	4.6 mm	3 pieces
LiChrospher® 100 RP-18	1.50183.7079	5 µm	250 mm	10 mm	1 piece
LiChrospher® 100 RP-18	1.50181.7080	7 µm	125 mm	4 mm	1 piece
LiChrospher® 100 RP-18	1.50012.7080	7 µm	125 mm	4.6 mm	1 piece
LiChrospher® 100 RP-18	1.50009.7080	7 µm	150 mm	4.6 mm	1 piece
LiChrospher® 100 RP-18	1.00424.7080	7 µm	250 mm	4.6 mm	1 piece
LiChrospher® 100 RP-18	1.50013.7081	10 µm	100 mm	4.6 mm	1 piece
LiChrospher® 100 RP-18	1.00424.7081	10 µm	250 mm	4.6 mm	1 piece
LiChrospher® 100 RP-18	1.50183.7081	10 µm	250 mm	10 mm	1 piece

The Hibar® columns are complete with endfittings. When using a guard column with a Hibar® column, we recommend part number 1.51487.0001 guard column cartridge holder for 4–4 mm guard column cartridges LiChroCART®. Additional dimensions available as customized packings see page 366.

Ordering information – LiChrospher® 100 RP-18 endcapped, stainless steel columns Hibar®

Product	Ordering No.	Particle size	Dimension length	Dimension i.d.	Contents of one package
LiChrospher® 100 RP-18 endcapped	1.51907.0001	5 µm	125 mm	2 mm	1 piece
LiChrospher® 100 RP-18 endcapped	1.50182.7085	5 µm	250 mm	4 mm	1 piece
LiChrospher® 100 RP-18 endcapped	1.50548.0001	5 µm	100 mm	4.6 mm	1 piece
LiChrospher® 100 RP-18 endcapped	1.51906.0001	5 µm	125 mm	4.6 mm	1 piece
LiChrospher® 100 RP-18 endcapped	1.50549.0001	5 µm	150 mm	4.6 mm	1 piece
LiChrospher® 100 RP-18 endcapped	1.50550.0001	5 µm	250 mm	4.6 mm	1 piece
LiChrospher® 100 RP-18 endcapped	1.50183.7085	5 µm	250 mm	10 mm	1 piece
LiChrospher® 100 RP-18 endcapped	1.50182.7084	10 µm	250 mm	4 mm	1 piece
LiChrospher® 100 RP-18 endcapped	1.50012.7084	10 µm	125 mm	4.6 mm	1 piece
LiChrospher® 100 RP-18 endcapped	1.50009.7084	10 µm	150 mm	4.6 mm	1 piece
LiChrospher® 100 RP-18 endcapped	1.00424.7084	10 µm	250 mm	4.6 mm	1 piece
LiChrospher® 100 RP-18 endcapped	1.50183.7084	10 µm	250 mm	10 mm	1 piece

LiChrospher® 100 RP-18 and RP-18 endcapped

Ordering information – LiChrospher® 100 RP-18, stainless steel cartridges LiChroCART®

Product	Ordering No.	Particle size	Dimension length	Dimension i.d.	Contents of one package
LiChrospher® 100 RP-18	1.50195.7079	5 µm	125 mm	2 mm	1 piece
LiChrospher® 100 RP-18	1.50190.7079	5 µm	250 mm	2 mm	1 piece
LiChrospher® 100 RP-18	1.50233.7079	5 µm	30 mm	3 mm	1 piece
LiChrospher® 100 RP-18	1.50159.0001	5 µm	125 mm	3 mm	1 piece
LiChrospher® 100 RP-18 (3 HPLC cartridges from 3 batches)	1.50159.1003	5 µm	125 mm	3 mm	3 pieces
LiChrospher® 100 RP-18	1.50154.0001	5 µm	250 mm	3 mm	1 piece
LiChrospher® 100 RP-18 (3 HPLC cartridges from 3 batches)	1.50154.1003	5 µm	250 mm	3 mm	3 pieces
LiChrospher® 100 RP-18	1.50957.0001	5 µm	4 mm	4 mm	10 pieces
LiChrospher® 100 RP-18	1.50931.0001	5 µm	25 mm	4 mm	3 pieces
LiChrospher® 100 RP-18	1.50302.7079	5 µm	30 mm	4 mm	1 piece
LiChrospher® 100 RP-18	1.50228.7079	5 µm	55 mm	4 mm	1 piece
LiChrospher® 100 RP-18	1.50987.0001	5 µm	75 mm	4 mm	3 pieces
LiChrospher® 100 RP-18	1.50823.0001	5 µm	125 mm	4 mm	1 piece
LiChrospher® 100 RP-18 (3 HPLC cartridges from 3 batches)	1.50823.1003	5 µm	125 mm	4 mm	3 pieces
LiChrospher® 100 RP-18	1.50943.0001	5 µm	125 mm	4 mm	3 pieces
LiChrospher® 100 RP-18	1.50833.0001	5 µm	250 mm	4 mm	1 piece
LiChrospher® 100 RP-18 (3 HPLC cartridges from 3 batches)	1.50833.1003	5 µm	250 mm	4 mm	3 pieces
LiChrospher® 100 RP-18	1.50983.0001	5 µm	250 mm	4 mm	3 pieces
LiChrospher® 100 RP-18	1.50600.0001	5 µm	100 mm	4.6 mm	1 piece
LiChrospher® 100 RP-18 (3 HPLC cartridges from 3 batches)	1.50600.1003	5 µm	100 mm	4.6 mm	3 pieces
LiChrospher® 100 RP-18	1.50601.0001	5 µm	150 mm	4.6 mm	1 piece
LiChrospher® 100 RP-18 (3 HPLC cartridges from 3 batches)	1.50601.1003	5 µm	150 mm	4.6 mm	3 pieces
LiChrospher® 100 RP-18	1.50602.0001	5 µm	250 mm	4.6 mm	1 piece
LiChrospher® 100 RP-18 (3 HPLC cartridges from 3 batches)	1.50602.1003	5 µm	250 mm	4.6 mm	3 pieces
LiChrospher® 100 RP-18	1.51442.7080	7 µm	125 mm	4.6 mm	1 piece
LiChrospher® 100 RP-18	1.51432.7080	7 µm	150 mm	4.6 mm	1 piece
LiChrospher® 100 RP-18	1.51431.7080	7 µm	250 mm	4.6 mm	1 piece
LiChrospher® 100 RP-18	1.50843.0001	10 µm	250 mm	4 mm	1 piece
LiChrospher® 100 RP-18	1.51448.7081	10 µm	100 mm	4.6 mm	1 piece
LiChrospher® 100 RP-18	1.51431.7081	10 µm	250 mm	4.6 mm	1 piece
LiChrospher® 100 RP-18	1.50853.0001	10 µm	250 mm	10 mm	1 piece

The LiChroCART® columns (75, 100, 125, 150 and 250 mm length) in the list above (2, 3, 4 and 4.6 mm i.d.) require part number 1.51486.0001 manu-CART® cartridge column holder, which can be used to hold one cartridge column with or without a 4–4 mm guard column. LiChroCART® columns 250–10 mm require part number 1.51419.0001 manu-CART® 10. Additional dimensions and validation kit available as customized packings see page 366.

Ordering information – LiChrospher® 100 RP-18 endcapped,
stainless steel cartridges LiChroCART®

Product	Ordering No.	Particle size	Dimension length	Dimension i.d.	Contents of one package
LiChrospher® 100 RP-18 endcapped	1.50190.7085	5 µm	250 mm	2 mm	1 piece
LiChrospher® 100 RP-18 endcapped	1.50175.7085	5 µm	125 mm	3 mm	1 piece
LiChrospher® 100 RP-18 endcapped	1.50177.7085	5 µm	250 mm	3 mm	1 piece
LiChrospher® 100 RP-18 endcapped	1.50962.0001	5 µm	4 mm	4 mm	10 pieces
LiChrospher® 100 RP-18 endcapped	1.50936.0001	5 µm	25 mm	4 mm	3 pieces
LiChrospher® 100 RP-18 endcapped	1.50228.7085	5 µm	55 mm	4 mm	1 piece
LiChrospher® 100 RP-18 endcapped	1.50171.7085	5 µm	75 mm	4 mm	1 piece
LiChrospher® 100 RP-18 endcapped	1.50828.0001	5 µm	125 mm	4 mm	1 piece
LiChrospher® 100 RP-18 endcapped	1.50734.0001	5 µm	125 mm	4 mm	3 pieces
LiChrospher® 100 RP-18 endcapped	1.50838.0001	5 µm	250 mm	4 mm	1 piece
LiChrospher® 100 RP-18 endcapped	1.50995.0001	5 µm	250 mm	4 mm	3 pieces
LiChrospher® 100 RP-18 endcapped	1.50603.0001	5 µm	100 mm	4.6 mm	1 piece
LiChrospher® 100 RP-18 endcapped	1.51908.0001	5 µm	125 mm	4.6 mm	1 piece
LiChrospher® 100 RP-18 endcapped	1.50604.0001	5 µm	150 mm	4.6 mm	1 piece
LiChrospher® 100 RP-18 endcapped	1.50605.0001	5 µm	250 mm	4.6 mm	1 piece
LiChrospher® 100 RP-18 endcapped	1.51443.7085	5 µm	125 mm	10 mm	1 piece
LiChrospher® 100 RP-18 endcapped	1.50236.7084	10 µm	55 mm	3 mm	1 piece
LiChrospher® 100 RP-18 endcapped	1.50302.7084	10 µm	30 mm	4 mm	1 piece
LiChrospher® 100 RP-18 endcapped	1.50170.7084	10 µm	125 mm	4 mm	1 piece
LiChrospher® 100 RP-18 endcapped	1.50848.0001	10 µm	250 mm	4 mm	1 piece
LiChrospher® 100 RP-18 endcapped	1.51432.7084	10 µm	150 mm	4.6 mm	1 piece
LiChrospher® 100 RP-18 endcapped	1.51431.7084	10 µm	250 mm	4.6 mm	1 piece
LiChrospher® 100 RP-18 endcapped	1.50858.0001	10 µm	250 mm	10 mm	1 piece

The LiChroCART® columns (75, 100, 125, 150 and 250 mm length) in the list above (2, 3, 4 and 4.6 mm i.d.) require part number 1.51486.0001 manu-CART® cartridge column holder, which can be used to hold one cartridge column with or without a 4–4 mm guard column. LiChroCART® columns 250–10 mm require part number 1.51419.0001 manu-CART® 10. Additional dimensions and validation kit available as customized packings see page 366.

Separation examples on LiChrospher® 100 RP-18

Pharmaceutical analysis: Acetyl salicylic acid

Column	LiChroCART® 250-4 LiChrospher® 100 RP-18, 5 µm
Mobile phase	0.01 mol/L sodiumdihydrogenphosphate pH 2.0 with phosphoric acid/Acetonitrile/ Methanol 70/25/5 (v/v/v)
Flow rate	1.0 mL/min
Detection	UV 237 nm
Temperature	Room temperature
Injection volume	100 µL
Sample	1. Acetylsalicylic acid 2. Salicylic acid 3. p-Hydroxybenzoic acid ethyl ester (internal standard)

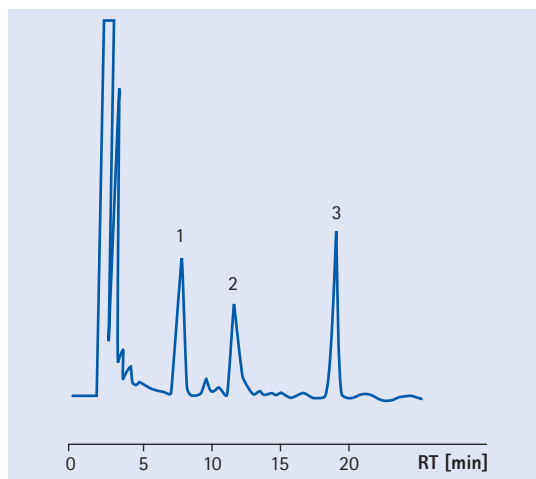

Pharmaceutical analysis: 2-Oxoacids

Column	LiChroCART® 250-4 LiChrospher® 100 RP-18, 5 µm
Mobile phase	Methanol/Water/Acetonitrile 35/45/20 (v/v/v)
Flow rate	1.0 mL/min
Detection	Fluorescence Ex 350 nm, Em 410 nm
Temperature	Room temperature
Injection volume	100 µL
Sample	1. Pyruvate 2. - 3. 2-Oxobutyric acid 4. 2-Oxoisovaleric acid (from valine) 5. 2-Oxoisocaproic acid (from leucine) 6. 2-Oxocaproic acid (internal standard) 7. 2-Oxo-3-methyl valeric acid (from isoleucine)

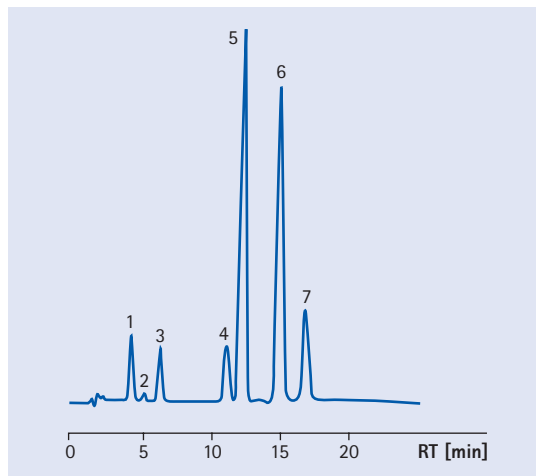

Pharmaceutical analysis: Corticoids

Column	LiChroCART® 125-4 LiChrospher® 100 RP-18, 5 µm
Mobile phase	Acetonitrile/0.5 mmol/L sodium acetate buffer 30/70 (v/v)
Flow rate	0.8 mL/min
Detection	UV 235 nm
Temperature	Room temperature
Injection volume	100 µL
Sample	1. Prednisolone 2. Cortisone 3. Dexamethasone 4. Prednisolone acetate 5. Hydrocortisone acetate 6. Cortisone acetate

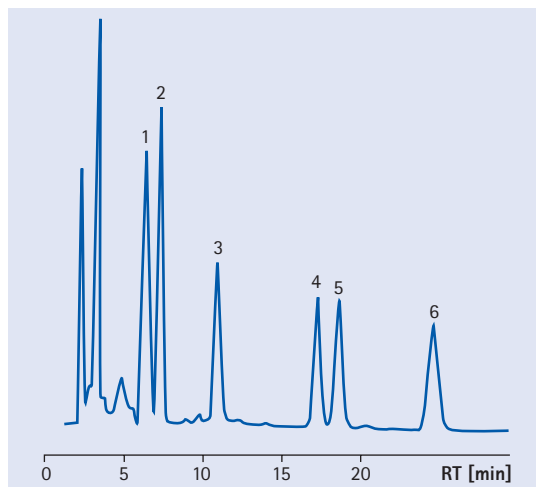

Separation examples on LiChrospher® 100 RP-18

Environmental analysis: Explosives

Column	LiChroCART® 250-3 LiChrospher® 100 RP-18, 5 µm
Mobile phase	A: Methanol B: Water
Gradient	0 min 26 % A 25 min 48 % A 55 min 48 % A
Flow rate	0.4 mL/min
Detection	Diode array detection 200-320 nm Spectral band with 4 nm
Temperature	32°C
Injection volume	50 µL
Sample	1. Octogene 2. Hexogene 3. 2-Amino-6-nitotoluene 4. 4-Amino-2-nitrotoluene 5. 1,3-Dinitrotoluene 6. Nitrobenzene 7. Trinitrobenzene 8. 4-Amino-2,6-dinitrotoluene 9. 2-Amino-4,6-dinitrotoluene 10. 3,4-Dinitrotoluene 11. 2,6-Dinitrotoluene 12. 2,4-Dinitrotoluene 13. 2-Nitrotoluene 14. 4-Nitrotoluene

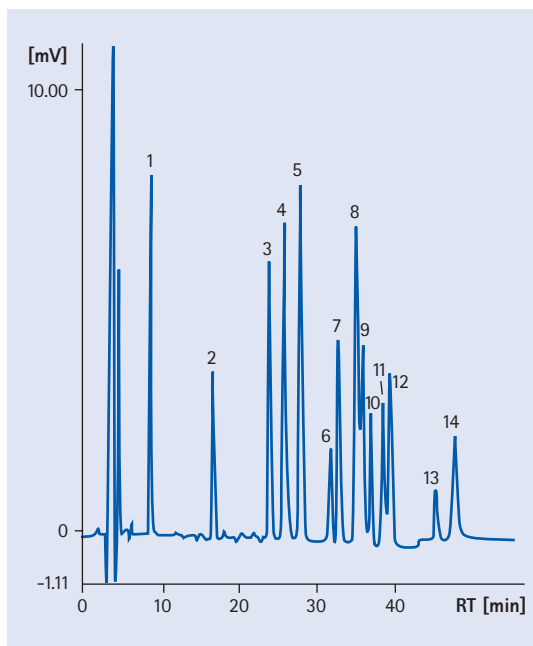

Environmental analysis: Naphthols, chlorophenol and nitro-aromatics in water

Column	LiChroCART® 250-4 LiChrospher® 100 RP-18, 5 µm
Mobile phase	Acetonitrile/Water 40/60 (v/v)
Flow rate	1.0 mL/min
Detection	Diode array detector min / 233 nm 15.70 min 263 nm 18.75 min 270 nm
Temperature	Room temperature
Injection volume	100 µL
Sample	1. 2-Naphthol 2. 1-Naphthol 3. 2,4-Dichlorophenol 4. 2,4-Dinitrotoluene 5. 2-Nitrotoluene 6. 4-Nitrotoluene 7. 2-Nitrotoluene

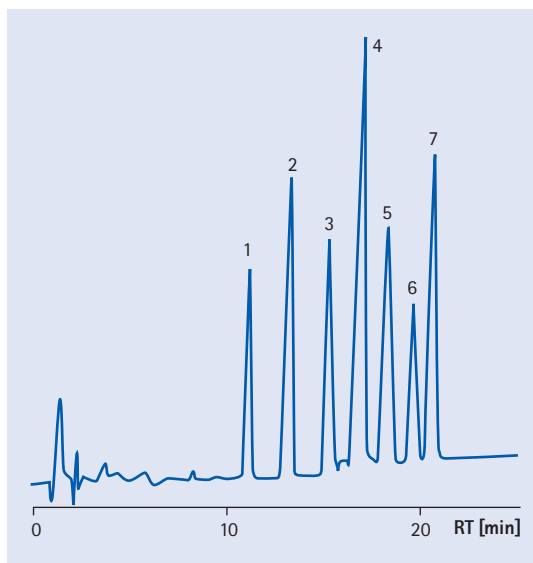

LiChrospher® WP 300 RP-18

High-resolution separations of peptides and tRNA molecules

LiChrospher® WP 300 RP-18 is a highly selective and reliable HPLC column for the separation of peptides and low molecular weight proteins. LiChrospher® WP 300 RP-18 enables the tailing-free separation of basic compounds and is excellently suited for the separation of tRNA molecules. High recovery rates are achieved, especially in the case of highly hydrophobic peptides.

Specifications of LiChrospher® WP 300 RP-18

Sorbent characteristics	Particles of silica with octadecyl derivative
Particle shape	spherical
Particle size	5, 12, 15 µm
Pore size	300 Å (30 nm)
Specific surface area	80 m ² /g
pH range	pH 2.0 – 7.5
Shipping eluent	Acetonitrile/Water

Ordering information – LiChrospher® WP 300 RP-18, stainless steel columns Hibar®

Product	Ordering No.	Particle size	Dimension length	Dimension i.d.	Contents of one package
LiChrospher® WP 300 RP-18	1.50181.7116	5 µm	125 mm	4 mm	1 piece

The Hibar® columns are complete with endfittings. When using a guard column with a Hibar® column, we recommend part number 1.51487.0001 guard column cartridge holder for 4–4 mm guard column cartridges LiChroCART®. Additional dimensions available as customized packings see page 366.

Ordering information – LiChrospher® WP 300 RP-18, stainless steel cartridges LiChroCART®

Product	Ordering No.	Particle size	Dimension length	Dimension i.d.	Contents of one package
LiChrospher® WP 300 RP-18	1.50195.7116	5 µm	125 mm	2 mm	1 piece
LiChrospher® WP 300 RP-18	1.50140.0001	5 µm	4 mm	4 mm	10 pieces
LiChrospher® WP 300 RP-18	1.50137.0001	5 µm	250 mm	4 mm	1 piece
LiChrospher® WP 300 RP-18	1.50179.7116	5 µm	250 mm	10 mm	1 piece

The LiChroCART® columns in the list above require part number 1.51486.0001 manu-CART® cartridge column holder, which can be used to hold one cartridge column with or without a 4–4 mm guard column. LiChroCART® columns 250–10 mm require part number 1.51419.0001 manu-CART® 10. Additional dimensions available as customized packings see page 366.

► **LiChrospher®**
Silica carrier for constant top-rate results
page 312

► **Customized packings**
Always the right column
page 366

Accessories for particulate HPLC columns:

► **manu-CART® cartridge holder** for LiChroCART® cartridges
page 370

► **LiChroCART® cartridge**
Different lengths, different internal diameter
page 373

Separation examples on LiChrospher® WP 300 RP-18

Angiotensin I and II

Column	LiChroCART® 250-4 LiChrospher® WP 300 RP-18, 5 µm
Mobile phase	A: Water + 0.1 % TFA B: Acetonitrile + 0.1 % TFA
Gradient	20 min 20 % B – 60 % B
Flow rate	0.6 mL/min
Detection	UV 214
Temperatur	Room temperature
Injection volume	100 µL
Sample	1. Angiotensin II (human) 2. Angiotensin I (human) each 1 mg/mL

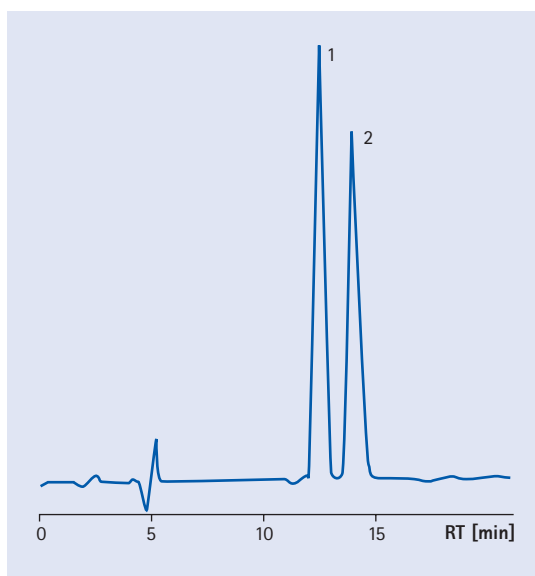

Poly-L-lysine peptides

Column	LiChroCART® 250-4 LiChrospher® WP 300 RP-18, 5 µm
Mobile phase	A: Water + 0.2 % TFA B: Acetonitrile + 0.2 % TFA
Gradient	60 min 0 % B – 100 % B
Flow rate	0.7 mL/min
Detection	UV 214
Temperatur	Room temperature
Injection volume	100 µL
Sample	Poly-L-lysine hydrobromide Molecular weight 1000 – 4000 Dalton

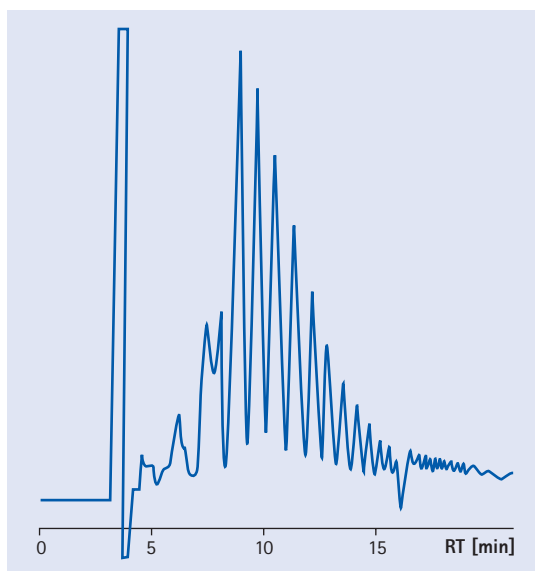

LiChrospher® PAH

Indispensable in PAH trace analysis

LiChrospher® PAH is a highly efficient and selective HPLC column especially designed for the high-resolution separation of 16 PAH (polycyclic aromatic hydrocarbons) according to EPA 610 and 550 + benzo(e)pyrene + perylene.

Polycyclic aromatic hydrocarbons (PAH) originate from organic material through pyrolysis or incomplete combustion. The main sources are the exhaust fumes of private and industrial furnaces, car exhaust and tobacco smoke. Since some PAH are carcinogenic, their determination is of great importance.

LiChrospher® PAH is based on an RP-18 silica gel special modified to achieve highly resolved PAH separations.

LiChrospher® PAH can be used for both the isocratic separation of 6 PAH according to the German DIN draft method and the gradient separation of 16 PAH according to EPA + benzo(e)pyrene + perylene.

LiChrospher® PAH produces excellent results for the separation of 16 PAH (EPA 610) + benzo(e)pyrene + perylene:

- baseline separation at 25° or 20°C by gradient HPLC (esp.: benzo(e)pyrene, benzo(b)fluoranthene and perylene)
- programmed fluorescence detection
- first-eluting PAH (naphthalene) at approx. 10 minutes
- separation within 30 minutes
- simple eluents and gradients

Specifications of LiChrospher® PAH

Sorbent characteristic	Particles of silica with octadecyl derivative
Particle shape	spherical
Particle size	5 µm
Pore size	150 Å (15 nm)
Specific surface area	200 m ² /g
Carbon load	20 %
pH range	pH 2 – 7.5
Shipping eluent	Acetonitrile/Water

Ordering information – LiChrospher® PAH, stainless steel columns Hibar®

Product	Ordering No.	Particle size	Dimension length	Dimension i.d.	Contents of one package
LiChrospher® PAH	1.50181.7078	5 µm	125 mm	4 mm	1 piece

The Hibar® columns are complete with endfittings. When using a guard column with a Hibar® column, we recommend part number 1.51487.0001 guard column cartridge holder for 4–4 mm guard column cartridges LiChroCART®. Additional dimensions available as customized packings see page 366.

Accessories for particulate HPLC columns:

- ▶ manu-CART® cartridge holder for LiChroCART® cartridges

page 370

- ▶ LiChroCART® cartridge
- Different lengths, different internal diameter

page 373

Ordering information – LiChrospher® PAH, stainless steel cartridges LiChroCART®

Packing material	Ordering No.	Particle size	Dimension Length	Dimension i.d.	Contents of one package
LiChrospher® PAH	1.50156.0001	5 µm	250 mm	3 mm	1 piece
LiChrospher® PAH	1.50148.0001	5 µm	4 mm	4 mm	10 pieces
LiChrospher® PAH	1.50302.7078	5 µm	30 mm	4 mm	1 piece
LiChrospher® PAH	1.50228.7078	5 µm	55 mm	4 mm	1 piece
LiChrospher® PAH	1.50149.0001	5 µm	250 mm	4 mm	1 piece
LiChrospher® PAH	1.51442.7078	5 µm	125 mm	4.6 mm	1 piece
LiChrospher® PAH	1.51432.7078	5 µm	150 mm	4.6 mm	1 piece
LiChrospher® PAH	1.51431.7078	5 µm	250 mm	4.6 mm	1 piece

The LiChroCART® columns (75, 125, 150 and 250 mm length) in the list above (3 and 4 mm i.d.) require part number 1.51486.0001 manu-CART® cartridge column holder, which can be used to hold one cartridge column with or without a 4–4 mm guard column.

Separation examples on LiChrospher® PAH

6 PAH acc. to EU-proposal ISO/CD 7981 + perylene by UV detection

Column	LiChroCART® 250-3 LiChrospher® PAH, 5 µm	
Mobile phase	Acetonitrile	
Flow rate	1.0 mL/min	
Detection	UV 254	
Temperature	25°C	
Injection volume	30 µL	
Sample	1. Fluoranthene	1.04 µg/mL
	2. Benzo(b)fluoranthene	0.68 µg/mL
	3. Perylene	0.72 µg/mL
	4. Benzo(k)fluoranthene	0.65 µg/mL
	5. Benzo(a)pyrene	0.60 µg/mL
	6. Benzo(g,h,i)perylene	0.65 µg/mL
	7. Ideno(1,2,3-c,d)pyrene	0.58 µg/mL

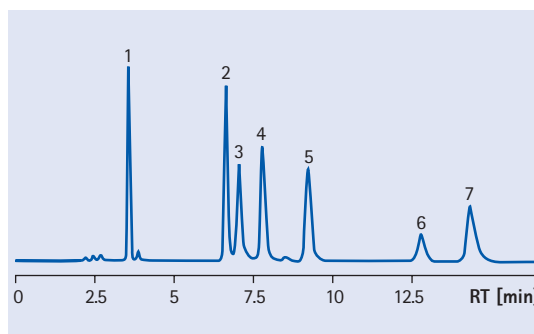

Separation examples on LiChrospher® PAH

16 PAH acc. to EPA 610/550 + benzo(e)pyrene + perylene by UV detection

Column	LiChroCART® 250-3 LiChrospher® PAH, 5 µm
Mobile phase	A: Acetonitrile B: Water
Gradient	0 – 3 min 50 % A 3 – 10 min 50 % A – 100 % A 10 – 45 min 100 % A
Flow rate	0.56 mL/min
Detection	UV 254
Temperature	20°C
Injection volume	20 µL

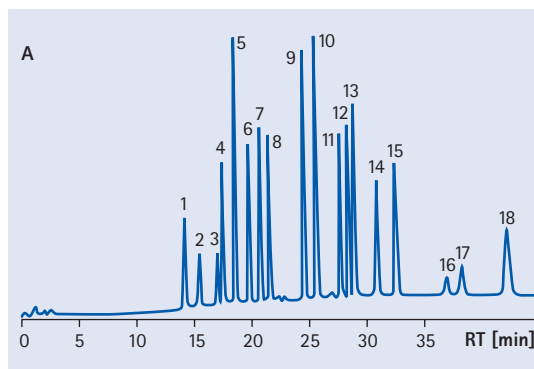

16 PAH acc. to EPA 610/550 + benzo(e)pyrene + perylene by fluorescence detection

Column	LiChroCART® 250-4 LiChrospher® PAH, 5 µm
Mobile phase	A: Acetonitrile B: Water
Gradient	0 – 3 min 60 % A 3 – 15 min 60 % A – 100 % A 15 – 50 min 100 % A
Flow rate	Flow rate 1.0 mL/min
Detection	Peak No. Ex [nm] Em [nm]
[programmed fluorescence detection]	1, 3, 4 280 330
	5 246 370
	6 250 406
	7 280 450
	8 270 390
	9, 10 265 380
	11 – 15 290 430
	16, 17 290 410
	18 300 500
Temperature	20°C
Injection volume	10 µL

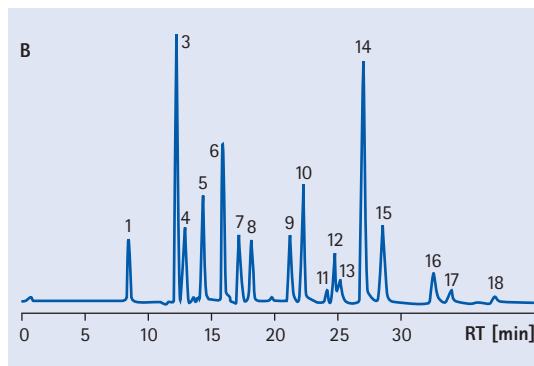

Sample	A [µg/mL]	B [ng/mL]
1. Naphthalene	2.00	100.0
2. Acenaphthylene	1.54	n.n.
3. Acenaphthene	2.06	103.0
4. Fluorene	0.48	24.0
5. Phenanthrene	0.35	17.5
6. Anthracene	0.08	4.0
7. Fluoranthene	0.77	4.0
8. Pyrene	0.85	42.5
9. Benzo(a)anthracene	0.41	20.5
10. Chrysene	0.37	18.5
11. Benzo(e)pyrene	1.00	37.0
12. Benzo(b)fluoranthene	0.42	21.0
13. Perylene	1.00	36.0
14. Benzo(k)fluoranthene	0.42	23.5
15. Benzo(a)pyrene	0.49	24.5
16. Dibenzo(a,h)anthracene	0.36	18.0
17. Benzo(g,h,i)perylene	0.37	18.5
18. Ideno(1,2,3-c,d)pyrene	0.43	21.5

LiChrospher® 100 RP-8 and RP-8 endcapped

For reproducible reversed phase separation

LiChrospher® 100 RP-8 and LiChrospher® 100 RP-8 endcapped are reliable and versatile traditionally produced spherical silica carriers with reversed-phase properties. They are well suited for the chromatography of acidic, neutral and weakly basic compounds, substances found frequently in all analytical fields. Their good column selectivity and performance ensure that these parameters remain constant from batch to batch and from year to year.

Specifications of LiChrospher® 100 RP-8 and RP-8 endcapped

	LiChrospher® 100 RP-8	LiChrospher® 100 RP-8 endcapped
Sorbent characteristics	Particles of silica with octyl derivative	Particles of silica with octyl derivative endcapped
Particle shape	spherical	spherical
Particle size	5; 10 µm	5; 10 µm
Pore size	100 Å (10 nm)	100 Å (10 nm)
Pore volume	1.25 mL/g	1.25 mL/g
Specific surface area	350 m ² /g	350 m ² /g
Carbon load	12.5 % C	13.0 % C
Coverage of the surface	4.04 µmol/m ²	4.44 µmol/m ²
Efficiency	55,000 N/m; 25,000 N/m	55,000 N/m; 25,000 N/m
pH range	pH 2-7.5	pH 2-7.5
Shipping eluent	Acetonitrile/Water	Acetonitrile/Water

Ordering information – LiChrospher® 100 RP-8 and RP-8 endcapped sorbents

Product	Ordering No.	Particle size	Package	Quantity
LiChrospher® 100 RP-8	1.16129.0010	5 µm	Glass	10 g
LiChrospher® 100 RP-8	1.16139.0010	10 µm	Glass	10 g
LiChrospher® 100 RP-8 endcapped	1.19636.0010	5 µm	Glass	10 g
LiChrospher® 100 RP-8 endcapped	1.19632.0010	10 µm	Glass	10 g

► **Purospher® STAR RP-8 endcapped** Ideal for less hydrophobic compounds [page 283](#)

► **Purospher® RP-18 endcapped** Excellent peak symmetry with either basic or strongly acidic compounds [page 302](#)

► **Purospher® RP-18** Polar endcapped column material [page 304](#)

► **Superspher®** Silica carrier for highly efficient separations [page 308](#)

► **LiChrosorb®** Irregular shaped silica sorbent [page 342](#)

► **Customized packings** Always the right column [page 366](#)

Accessories for particulate HPLC columns:

► **manu-CART® cartridge holder** for LiChroCART® cartridges [page 370](#)

► **LiChroCART® cartridge** Different lengths, different internal diameter [page 373](#)

LiChrospher® 100 RP-8 and RP-8 endcapped

Ordering information – LiChrospher® 100 RP-8 and RP-8 endcapped, stainless steel columns Hibar®

Product	Ordering No.	Particle size	Dimension length	Dimension i.d.	Contents of one package
LiChrospher® 100 RP-8	1.00423.7087	5 µm	250 mm	3 mm	1 piece
LiChrospher® 100 RP-8	1.50181.7087	5 µm	125 mm	4 mm	1 piece
LiChrospher® 100 RP-8	1.50329.0001	5 µm	250 mm	4 mm	1 piece
LiChrospher® 100 RP-8	1.50578.0001	5 µm	100 mm	4.6 mm	1 piece
LiChrospher® 100 RP-8	1.50012.7087	5 µm	125 mm	4.6 mm	1 piece
LiChrospher® 100 RP-8	1.50579.0001	5 µm	150 mm	4.6 mm	1 piece
LiChrospher® 100 RP-8	1.50580.0001	5 µm	250 mm	4.6 mm	1 piece
LiChrospher® 100 RP-8	1.50181.7088	10 µm	125 mm	4 mm	1 piece
LiChrospher® 100 RP-8	1.50012.7088	10 µm	125 mm	4.6 mm	1 piece
LiChrospher® 100 RP-8	1.50183.7088	10 µm	250 mm	10 mm	1 piece
LiChrospher® 100 RP-8 endcapped	1.50181.7092	5 µm	125 mm	4 mm	1 piece
LiChrospher® 100 RP-8 endcapped	1.50581.0001	5 µm	100 mm	4.6 mm	1 piece
LiChrospher® 100 RP-8 endcapped	1.50582.0001	5 µm	150 mm	4.6 mm	1 piece
LiChrospher® 100 RP-8 endcapped	1.50583.0001	5 µm	250 mm	4.6 mm	1 piece
LiChrospher® 100 RP-8 endcapped	1.50182.7091	10 µm	250 mm	4 mm	1 piece
LiChrospher® 100 RP-8 endcapped	1.50009.7091	10 µm	150 mm	4.6 mm	1 piece
LiChrospher® 100 RP-8 endcapped	1.00424.7091	10 µm	250 mm	4.6 mm	1 piece

The Hibar® columns are complete with endfittings. When using a guard column with a Hibar® column, we recommend part number 1.51487.0001 guard column cartridge holder for 4–4 mm guard column cartridges LiChroCART®. Additional dimensions available as customized packings see page 366.

Ordering information – LiChrospher® 100 RP-8 and RP-8 endcapped,
stainless steel cartridges LiChroCART®

Product	Ordering No.	Particle size	Dimension length	Dimension i.d.	Contents of one package
LiChrospher® 100 RP-8	1.50190.7087	5 µm	250 mm	2 mm	1 piece
LiChrospher® 100 RP-8	1.50177.7087	5 µm	250 mm	3 mm	1 piece
LiChrospher® 100 RP-8	1.50956.0001	5 µm	4 mm	4 mm	10 pieces
LiChrospher® 100 RP-8	1.50930.0001	5 µm	25 mm	4 mm	3 pieces
LiChrospher® 100 RP-8	1.50228.7087	5 µm	55 mm	4 mm	1 piece
LiChrospher® 100 RP-8	1.50986.0001	5 µm	75 mm	4 mm	3 pieces
LiChrospher® 100 RP-8	1.50822.0001	5 µm	125 mm	4 mm	1 piece
LiChrospher® 100 RP-8	1.50942.0001	5 µm	125 mm	4 mm	3 pieces
LiChrospher® 100 RP-8	1.50832.0001	5 µm	250 mm	4 mm	1 piece
LiChrospher® 100 RP-8	1.50982.0001	5 µm	250 mm	4 mm	3 pieces
LiChrospher® 100 RP-8	1.50634.0001	5 µm	100 mm	4.6 mm	1 piece
LiChrospher® 100 RP-8	1.50635.0001	5 µm	150 mm	4.6 mm	1 piece
LiChrospher® 100 RP-8	1.50636.0001	5 µm	250 mm	4.6 mm	1 piece
LiChrospher® 100 RP-8	1.51443.7087	5 µm	125 mm	10 mm	1 piece
LiChrospher® 100 RP-8	1.50842.0001	10 µm	250 mm	4 mm	1 piece
LiChrospher® 100 RP-8	1.51448.7088	10 µm	100 mm	4.6 mm	1 piece
LiChrospher® 100 RP-8	1.50179.7088	10 µm	250 mm	10 mm	1 piece
LiChrospher® 100 RP-8 endcapped	1.50175.7092	5 µm	125 mm	3 mm	1 piece
LiChrospher® 100 RP-8 endcapped	1.50177.7092	5 µm	250 mm	3 mm	1 piece
LiChrospher® 100 RP-8 endcapped	1.50961.0001	5 µm	4 mm	4 mm	10 pieces
LiChrospher® 100 RP-8 endcapped	1.50827.0001	5 µm	125 mm	4 mm	1 piece
LiChrospher® 100 RP-8 endcapped	1.50837.0001	5 µm	250 mm	4 mm	1 piece
LiChrospher® 100 RP-8 endcapped	1.50637.0001	5 µm	100 mm	4.6 mm	1 piece
LiChrospher® 100 RP-8 endcapped	1.51442.7092	5 µm	125 mm	4.6 mm	1 piece
LiChrospher® 100 RP-8 endcapped	1.50638.0001	5 µm	150 mm	4.6 mm	1 piece
LiChrospher® 100 RP-8 endcapped	1.50639.0001	5 µm	250 mm	4.6 mm	1 piece
LiChrospher® 100 RP-8 endcapped	1.50234.7091	10 µm	55 mm	2 mm	1 piece
LiChrospher® 100 RP-8 endcapped	1.50236.7091	10 µm	55 mm	3 mm	1 piece
LiChrospher® 100 RP-8 endcapped	1.50847.0001	10 µm	250 mm	4 mm	1 piece
LiChrospher® 100 RP-8 endcapped	1.51432.7091	10 µm	150 mm	4.6 mm	1 piece
LiChrospher® 100 RP-8 endcapped	1.51431.7091	10 µm	250 mm	4.6 mm	1 piece
LiChrospher® 100 RP-8 endcapped	1.50179.7091	10 µm	250 mm	10 mm	1 piece

The LiChroCART® columns (75, 100, 125, 150 and 250 mm length) in the list above (4 or 4.6 mm i.d.) require part number 1.51486.0001 manu-CART® cartridge column holder, which can be used to hold one cartridge column with or without a 4–4 mm guard column. LiChroCART® columns 250–10 mm require part number 1.51419.0001 manu-CART® 10. Additional dimensions available as customized packings see page 366.

Separation examples on LiChrospher® 100 RP-8, 5 µm

Nucleotides

Column	LiChrospher® 100 RP-8, 5 µm
Mobile phase	Acetonitrile/0.05 M phosphate buffer pH 6.5 90/10 (v/v) + 0.001 mol/L TBAHSO ₄
Flow rate	1.5 mL/min
Detection	UV 254 nm
Sample	1. NAD 2. Adenosine 3. NADH 4. NADPH

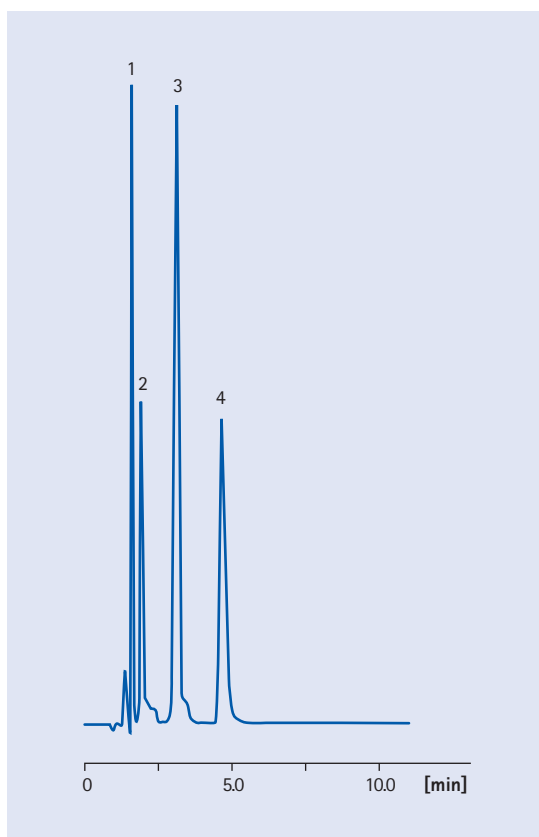

Digitalis

Column	LiChrospher® 100 RP-8, 5 µm
Mobile phase	Acetonitrile/0.05 M phosphate buffer pH 3.5 32/68 (v/v)
Flow rate	1.5 mL/min
Detection	UV 254 nm
Sample	1. Digoxigenine 2. Lanatosid C 3. Digoxine 4. Gitoxigenine 5. Digitoxigenine

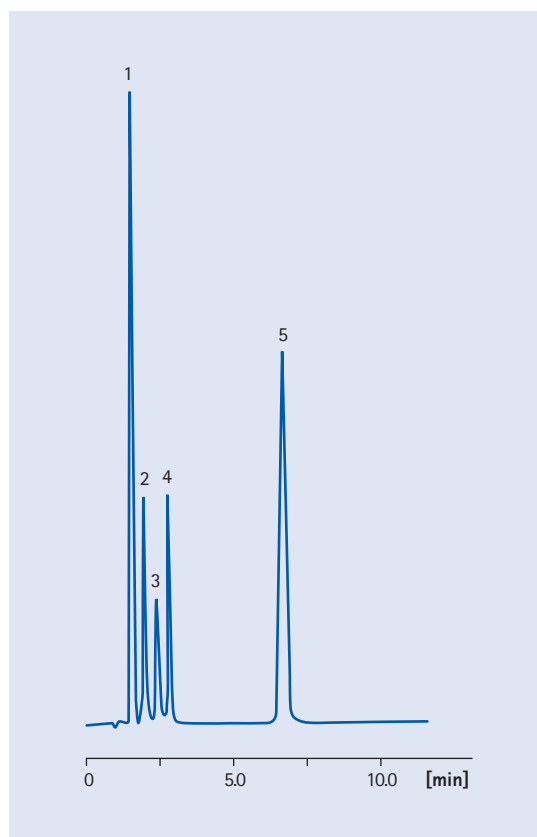

LiChrospher® 60 RP-select B

Excellent separations even with basic compounds

LiChrospher® RP-select B is a versatile reversed-phase sorbent based on spherical silica particles with excellent properties for the determination of basic substances, but with still good properties for the determination of neutral and acidic substances. **LiChrospher® 60 RP-select B is optimized in order to prevent any secondary interactions with basic substances and ensures that basic compounds are eluted as symmetrical substance peaks.**

Highest reliability of your HPLC results

The basis for the success of your HPLC analysis is the safety of an HPLC method that provides highly reproducible results. LiChrospher® RP-select B meets your challenging demands regarding excellent batch-to-batch reproducibility of an HPLC sorbent. A masterbatch concept, where several individual batches are used to produce a large batch ("the masterbatch") of the LiChrospher® RP-select B sorbent, is applied with the aim of eliminating the variations between the different individual batches.



Specifications of LiChrospher® 60 RP-select B

Sorbent characteristics	Particles of silica with octyl derivative
Particle shape	spherical
Particle size	5; 10 µm
Pore size	60 Å (6 nm)
Pore volume	0.9 mL/g
Specific surface area	360 m ² /g
Carbon load	11.5 % C
Coverage of the surface	3.55 µmol/m ²
Efficiency	55,000 N/m; 25,000 N/m
pH range	pH 2-7.5
Shipping eluent	Acetonitrile/Water

► **Purospher® STAR RP-8 endcapped** Ideal for less hydrophobic compounds
page 283

► **Purospher® RP-18 endcapped** Excellent peak symmetry with either basic or strongly acidic compounds
page 302

► **Purospher® RP-18** Polar endcapped column material
page 304

► **Superspher®** Silica carrier for highly efficient separations
page 308

► **LiChrospher®** Silica carrier for constant top-rate results
page 312

► **LiChrosorb®** Irregular shaped silica sorbent
page 342

► **Customized packings** Always the right column
page 366

Accessories for particulate HPLC columns:

► **manu-CART® cartridge holder** for LiChroCART® cartridges
page 370

► **LiChroCART® cartridge** Different lengths, different internal diameter
page 373

Ordering information – LiChrospher® 60 RP-select B sorbents

Product	Ordering No.	Particle size	Package	Quantity
LiChrospher® 60 RP-select B	1.19641.0010	5 µm	Glass	10 g
LiChrospher® 60 RP-select B	1.19642.0010	10 µm	Glass	10 g
LiChrospher® 60 RP-select B	1.19642.0100	10 µm	Glass	100 g

Ordering information – LiChrospher® 60 RP-select B, stainless steel columns Hibar®

Product	Ordering No.	Particle size	Dimension length	Dimension i.d.	Contents of one package
LiChrospher® 60 RP-select B	1.50181.7093	5 µm	125 mm	4 mm	1 piece
LiChrospher® 60 RP-select B	1.50182.7093	5 µm	250 mm	4 mm	1 piece
LiChrospher® 60 RP-select B	1.50573.0001	5 µm	100 mm	4.6 mm	1 piece
LiChrospher® 60 RP-select B (3 HPLC columns from 3 batches)	1.50573.1003	5 µm	100 mm	4.6 mm	3 pieces
LiChrospher® 60 RP-select B	1.50012.7093	5 µm	125 mm	4.6 mm	1 piece
LiChrospher® 60 RP-select B	1.50574.0001	5 µm	150 mm	4.6 mm	1 piece
LiChrospher® 60 RP-select B (3 HPLC columns from 3 batches)	1.50574.1003	5 µm	150 mm	4.6 mm	3 pieces
LiChrospher® 60 RP-select B	1.50575.0001	5 µm	250 mm	4.6 mm	1 piece
LiChrospher® 60 RP-select B (3 HPLC columns from 3 batches)	1.50575.1003	5 µm	250 mm	4.6 mm	3 pieces
LiChrospher® 60 RP-select B	1.50183.7094	10 µm	250 mm	10 mm	1 piece

The Hibar® columns are complete with endfittings. When using a guard column with a Hibar® column, we recommend part number 1.51487.0001 guard column cartridge holder for 4–4 mm guard column cartridges LiChroCART®. Additional dimensions available as customized packings see page 366.

Ordering information – LiChrospher® 60 RP-select B, stainless steel cartridges LiChroCART®

Product	Ordering No.	Particle size	Dimension length	Dimension i.d.	Contents of one package
LiChrospher® 60 RP-select B	1.50195.7093	5 µm	125 mm	2 mm	1 piece
LiChrospher® 60 RP-select B	1.50158.0001	5 µm	125 mm	3 mm	1 piece
LiChrospher® 60 RP-select B (3 HPLC cartridges from 3 batches)	1.50158.1003	5 µm	125 mm	3 mm	3 pieces
LiChrospher® 60 RP-select B	1.50155.0001	5 µm	250 mm	3 mm	1 piece
LiChrospher® 60 RP-select B (3 HPLC cartridges from 3 batches)	1.50155.1003	5 µm	250 mm	3 mm	3 pieces
LiChrospher® 60 RP-select B	1.50963.0001	5 µm	4 mm	4 mm	10 pieces
LiChrospher® 60 RP-select B	1.50937.0001	5 µm	25 mm	4 mm	3 pieces
LiChrospher® 60 RP-select B	1.50993.0001	5 µm	75 mm	4 mm	3 pieces
LiChrospher® 60 RP-select B	1.50829.0001	5 µm	125 mm	4 mm	1 piece
LiChrospher® 60 RP-select B	1.50981.0001	5 µm	125 mm	4 mm	3 pieces
LiChrospher® 60 RP-select B (3 HPLC cartridges from 3 batches)	1.50981.1003	5 µm	125 mm	4 mm	3 pieces
LiChrospher® 60 RP-select B	1.50839.0001	5 µm	250 mm	4 mm	1 piece
LiChrospher® 60 RP-select B (3 HPLC cartridges from 3 batches)	1.50839.1003	5 µm	250 mm	4 mm	3 pieces
LiChrospher® 60 RP-select B	1.50984.0001	5 µm	250 mm	4 mm	3 pieces
LiChrospher® 60 RP-select B	1.50640.0001	5 µm	100 mm	4.6 mm	1 piece
LiChrospher® 60 RP-select B (3 HPLC cartridges from 3 batches)	1.50640.1003	5 µm	100 mm	4.6 mm	3 pieces
LiChrospher® 60 RP-select B	1.50641.0001	5 µm	150 mm	4.6 mm	1 piece
LiChrospher® 60 RP-select B (3 HPLC cartridges from 3 batches)	1.50641.1003	5 µm	150 mm	4.6 mm	3 pieces
LiChrospher® 60 RP-select B	1.50642.0001	5 µm	250 mm	4.6 mm	1 piece
LiChrospher® 60 RP-select B (3 HPLC cartridges from 3 batches)	1.50642.1003	5 µm	250 mm	4.6 mm	3 pieces
LiChrospher® 60 RP-select B	1.50742.0001	10 µm	250 mm	4 mm	1 piece

The LiChroCART® columns (75, 100, 125, 150 and 250 mm length) in the list above (3, 4 and 4.6 mm i.d.) require part number 1.51486.0001. manu-CART® cartridge column holder, which can be used to hold one cartridge column with or without a 4–4 mm guard column. Additional dimensions and validation kit available as customized packings see page 366.

Separation examples on LiChrospher® 60 RP-select B

Environmental analysis: Phenols

Column	LiChroCART® 250-4 LiChrospher® 60 RP-select B, 5 µm	
Mobile phase	A: Water LiChrosolv® + 1 % Acetic acid (96 %) B: Acetonitrile LiChrosolv® + 1 % Acetic acid (96 %)	
Gradient	0 – 10 min	30 % B
	10 – 28 min	30 – 80 % B
	28 – 29 min	80 – 30 % B
	29 – 35 min	30 % B
Flow rate	1.0 mL/min	
Detection	Diode array	Detector
	0.0 min	362 nm
	6.0 min	273 nm
	8.5 min	319 nm
	11.0 min	278 nm
	16.0 min	283 nm
	19.5 min	269 nm
	22.0 min	293 nm
	25.0 min	304 nm
Temperature	30°C	
Injection volume	100 µL	
Sample	1. Picric acid	7. 2,4-Dimethylphenol
	2. Phenol	8. 4-Chloro-3-methylphenol
	3. 4-Nitrophenol	9. 2-Methyl-4,6-dinitrophenol
	4. 2-Chlorophenol	10. 2,4,6-Trichlorophenol
	5. 2,4-Dinitrophenol	11. Pentachlorophenol
	6. 2-Nitrophenol	

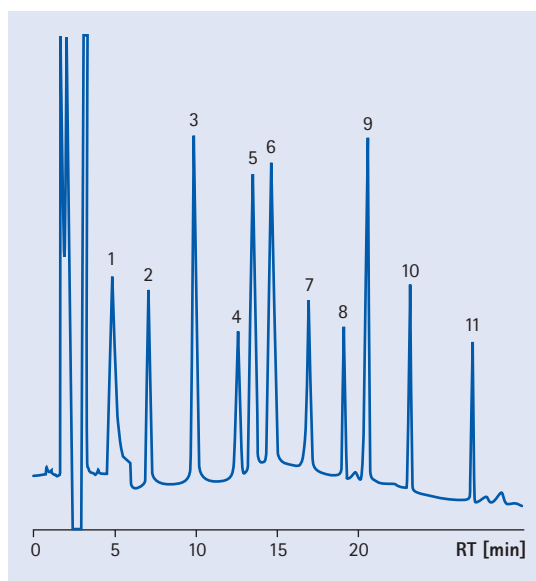

Environmental analysis: Fungicides in wine

Column	LiChroCART® 125-4 LiChrospher® 60 RP-select B, 5 µm
Mobile phase	Acetonitrile/Water 45/55 (v/v)
Flow rate	0.8 mL/min
Detection	UV 215
Temperature	Room temperature
Injection volume	50 µL
Sample	1. Iprodione 2. Procymidone 3. Vinclozoline

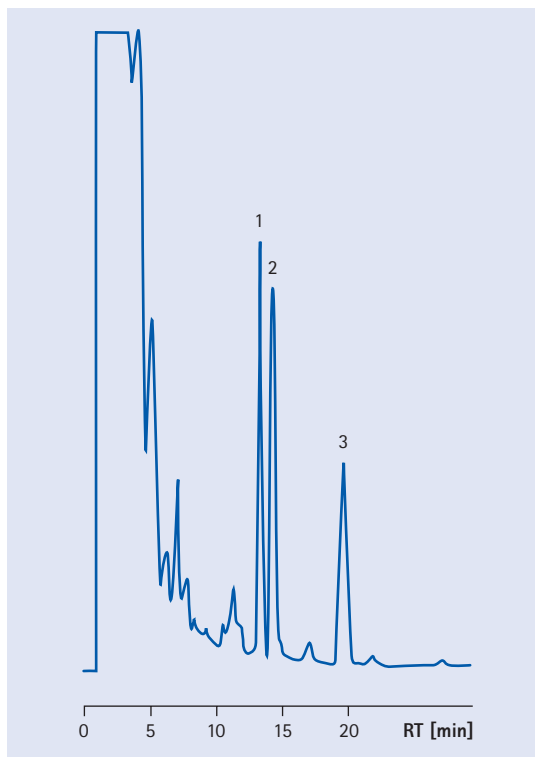

Alkaloids

Column	LiChroCART® 250-4 LiChrospher® 60 RP-select B, 5 µm
Mobile phase	A: 0.05 mol/L KH ₂ PO B: Methanol
Gradient	0 – 35 min 90 % A – 55 % A 35 – 40 min 55 % A – 40 % A 40 – 60 min 40 % A 60 – 70 min 40 % A – 25 % A 70 – 80 min 25 % A – 20 % A
Flow rate	0.7 mL/min
Detection	UV 285
Temperature	Room temperature
Injection volume	20 µL
Sample	1. α-Homochelidonine 2. Chelidonine 3. Protopine 4. Allocryptopine 5. Stylopine 6. Coptisine 7. Berberine 8. Sanguinarine 9. Chelerythrine

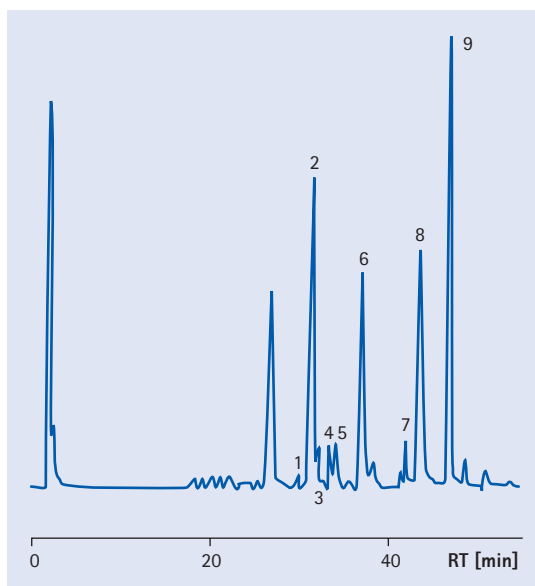

LiChrospher® 100 CN

Excellent for complex samples with polar and hydrophobic characteristics

LiChrospher® 100 CN has both polar and hydrophobic properties, thus can be used as a less polar alternative to LiChrospher® Si 60 in normal phase applications or as a less hydrophobic alternative to LiChrospher® RP-8 in reversed-phase applications. The combination of weak hydrophobic interactions and polar interactions enables successful separations of complex samples. In addition, the possibility of selective charged interactions makes it even more versatile.

Specifications of LiChrospher® 100 CN

Sorbent characteristics	Particles of silica with g-Cyanopropyl function
Particle shape	spherical
Particle size	5; 10 µm
Pore size	100 Å (10 nm)
Pore volume	1.25 mL/g
Specific surface area	350 m ² /g
Carbon load	6.6 % C
Coverage of the surface	3.52 µmol/m ²
Efficiency	40,000 N/m; 15,000 N/m
pH range	pH 2-7.5
Shipping eluent	n-Heptane

► **Superspher®**
Silica carrier for highly efficient separations
page 308

► **LiChrosorb®**
Irregular shaped silica sorbent
page 342

► **Customized packings**
Always the right column
page 366

Accessories for particulate HPLC columns:

► **manu-CART® cartridge holder** for LiChroCART® cartridges
page 370

► **LiChroCART® cartridge**
Different lengths, different internal diameter
page 373



Ordering information – LiChrospher® 100 CN sorbents

Product	Ordering No.	Particle size	Package	Quantity
LiChrospher® 100 CN	1.19638.0010	5 µm	Glass	10 g

Ordering information – LiChrospher® 60 RP-select B, stainless steel columns Hibar®

Product	Ordering No.	Particle size	Dimension length	Dimension i.d.	Contents of one package
LiChrospher® 100 CN	1.50181.7071	5 µm	125 mm	4 mm	1 piece
LiChrospher® 100 CN	1.50012.7071	5 µm	125 mm	4.6 mm	1 piece
LiChrospher® 100 CN	1.00424.7071	5 µm	250 mm	4.6 mm	1 piece
LiChrospher® 100 CN	1.50009.7070	10 µm	150 mm	4.6 mm	1 piece

The Hibar® columns are complete with endfittings. When using a guard column with a Hibar® column, we recommend part number 1.51487.0001 guard column cartridge holder for 4–4 mm guard column cartridges LiChroCART®. Additional dimensions available as customized packings see page 366.

Ordering information – LiChrospher® 100 CN, stainless steel cartridges LiChroCART®

Product	Ordering No.	Particle size	Dimension length	Dimension i.d.	Contents of one package
LiChrospher® 100 CN	1.50959.0001	5 µm	4 mm	4 mm	10 pieces
LiChrospher® 100 CN	1.50171.7071	5 µm	75 mm	4 mm	1 piece
LiChrospher® 100 CN	1.50825.0001	5 µm	125 mm	4 mm	1 piece
LiChrospher® 100 CN	1.50892.0001	5 µm	250 mm	4 mm	1 piece
LiChrospher® 100 CN	1.50845.0001	10 µm	250 mm	4 mm	1 piece

The LiChroCART® columns (125 and 250 mm length) in the list above (4 mm i.d.) require part number 1.51486.0001. manu-CART® cartridge column holder, which can be used to hold one cartridge column with or without a 4–4 mm guard column. Additional dimensions available as customized packings see page 366.

LiChrospher® 100 NH₂

A versatile sorbent for both reversed phase and normal phase chromatography

LiChrospher® 100 NH₂ provides polar and hydrophobic properties and can be used for normal phase chromatography, reversed-phase chromatography and ion exchange chromatography. Typical applications are the separation of carbohydrates (mono-, di- and oligosaccharides) with reversed phase chromatography or the separation of nucleotides with LiChrospher® NH₂ as weak anion exchanger.

Specifications of LiChrospher® 100 NH₂

Sorbent characteristics	Particles of silica with γ -Aminopropyl function
Particle shape	spherical
Particle size	5; 10 μm
Pore size	100 Å (10 nm)
Pore volume	1.25 mL/g
Specific surface area	350 m ² /g
Carbon load	4.6 % C
Coverage of the surface	4.1 $\mu\text{mol}/\text{m}^2$
Efficiency	25,000 N/m; 20,000 N/m
pH range	pH 2-7.5
Shipping eluent	n-Heptane

► **Purospher® STAR**
Si (Silica) and NH₂
(Amino-phase)
page 289

► **Superspher®**
Silica carrier for highly
efficient separations
page 308

► **LiChrosorb®**
Irregular shaped silica
sorbent
page 342

► **Customized packings**
Always the right column
page 366

Accessories for particulate
HPLC columns:

► **manu-CART® cartridge
holder** for LiChroCART®
cartridges
page 370

► **LiChroCART® cartridge**
Different lengths, differ-
ent internal diameter
page 373



Ordering information – LiChrospher® 100 NH₂ sorbents

Product	Ordering No.	Particle size	Package	Quantity
LiChrospher® 100 NH ₂	1.16178.0010	5 µm	Glass	10 g

Ordering information – LiChrospher® 100 NH₂, stainless steel columns Hibar®

Product	Ordering No.	Particle size	Dimension length	Dimension i.d.	Contents of one package
LiChrospher® 100 NH ₂	1.50181.7076	5 µm	125 mm	4 mm	1 piece
LiChrospher® 100 NH ₂	1.50182.7076	5 µm	250 mm	4 mm	1 piece
LiChrospher® 100 NH ₂	1.50013.7076	5 µm	100 mm	4.6 mm	1 piece
LiChrospher® 100 NH ₂	1.50012.7076	5 µm	125 mm	4.6 mm	1 piece
LiChrospher® 100 NH ₂	1.51905.0001	5 µm	150 mm	4.6 mm	1 piece
LiChrospher® 100 NH ₂	1.51904.0001	5 µm	250 mm	4.6 mm	1 piece
LiChrospher® 100 NH ₂	1.50183.7076	5 µm	250 mm	10 mm	1 piece
LiChrospher® 100 NH ₂	1.50012.7077	10 µm	125 mm	4.6 mm	1 piece
LiChrospher® 100 NH ₂	1.00424.7077	10 µm	250 mm	4.6 mm	1 piece

The Hibar® columns are complete with endfittings. When using a guard column with a Hibar® column, we recommend part number 1.51487.0001 guard column cartridge holder for 4–4 mm guard column cartridges LiChroCART®. Additional dimensions available as customized packings see page 366.

Ordering information – LiChrospher® 100 NH₂, stainless steel cartridges LiChroCART®

Product	Ordering No.	Particle size	Dimension length	Dimension i.d.	Contents of one package
LiChrospher® 100 NH ₂	1.50175.7076	5 µm	125 mm	3 mm	1 piece
LiChrospher® 100 NH ₂	1.50177.7076	5 µm	250 mm	3 mm	1 piece
LiChrospher® 100 NH ₂	1.50958.0001	5 µm	4 mm	4 mm	10 pieces
LiChrospher® 100 NH ₂	1.50932.0001	5 µm	25 mm	4 mm	3 pieces
LiChrospher® 100 NH ₂	1.50302.7076	5 µm	30 mm	4 mm	1 piece
LiChrospher® 100 NH ₂	1.50824.0001	5 µm	125 mm	4 mm	1 piece
LiChrospher® 100 NH ₂	1.50834.0001	5 µm	250 mm	4 mm	1 piece
LiChrospher® 100 NH ₂	1.51431.7076	5 µm	250 mm	4.6 mm	1 piece
LiChrospher® 100 NH ₂	1.50170.7077	10 µm	125 mm	4 mm	1 piece
LiChrospher® 100 NH ₂	1.50844.0001	10 µm	250 mm	4 mm	1 piece
LiChrospher® 100 NH ₂	1.51442.7077	10 µm	125 mm	4.6 mm	1 piece
LiChrospher® 100 NH ₂	1.51431.7077	10 µm	250 mm	4.6 mm	1 piece

The LiChroCART® columns (125 and 250 mm length) in the list above (4 mm i.d.) require part number 1.51486.0001. manu-CART® cartridge column holder, which can be used to hold one cartridge column with or without a 4–4 mm guard column. Additional dimensions available as customized packings see page 366.

LiChrospher® 100 DIOL

Excellent for complex samples with polar and hydrophobic characteristics and for exclusion chromatography

LiChrospher® 100 DIOL provides both polar and hydrophobic properties, thus can be used as a less polar alternative to LiChrospher® Si 60 in normal phase applications or as a less hydrophobic alternative with some limitations to LiChrospher® RP-8 in reversed-phase applications. The combination of weak hydrophobic interactions and polar interactions enables successful separations of complex samples. In addition, LiChrospher® 100 DIOL is also suitable for exclusion chromatography.

Specifications of LiChrospher® 100 DIOL

Sorbent characteristics	Particles of silica with Diol function on C-chains
Particle shape	spherical
Particle size	5; 10 µm
Pore size	100 Å (10 nm)
Pore volume	1.25 mL/g
Specific surface area	350 m ² /g
Carbon load	8.0 % C
Coverage of the surface	3.87 µmol/m ²
Efficiency	45,000 N/m; 20,000 N/m
pH range	pH 2-7.5
Shipping eluent	n-Heptane

► **Superspher®**
Silica carrier for highly efficient separations
page 308

► **LiChrosorb®**
Irregular shaped silica sorbent
page 342

► **Customized packings**
Always the right column
page 366

Accessories for particulate HPLC columns:

► **manu-CART® cartridge holder** for LiChroCART® cartridges
page 370

► **LiChroCART® cartridge**
Different lengths, different internal diameter
page 373



Ordering information – LiChrospher® 100 DIOL sorbents

Product	Ordering No.	Particle size	Package	Quantity
LiChrospher® 100 DIOL	1.16152.0010	5 µm	Glass	10 g

Ordering information – LiChrospher® 100 DIOL, stainless steel columns Hibar®

Product	Ordering No.	Particle size	Dimension length	Dimension i.d.	Contents of one package
LiChrospher® 100 DIOL	1.50182.7075	5 µm	250 mm	4 mm	1 piece
LiChrospher® 100 DIOL	1.50009.7075	5 µm	150 mm	4.6 mm	1 piece
LiChrospher® 100 DIOL	1.00424.7075	5 µm	250 mm	4.6 mm	1 piece
LiChrospher® 100 DIOL	1.50183.7075	5 µm	250 mm	10 mm	1 piece

The Hibar® columns are complete with endfittings. When using a guard column with a Hibar® column, we recommend part number 1.51487.0001 guard column cartridge holder for 4–4 mm guard column cartridges LiChroCART®. Additional dimensions available as customized packings see page 366.

Ordering information – LiChrospher® 100 DIOL, stainless steel cartridges LiChroCART®

Product	Ordering No.	Particle size	Dimension length	Dimension i.d.	Contents of one package
LiChrospher® 100 DIOL	1.50190.7075	5 µm	250 mm	2 mm	1 piece
LiChrospher® 100 DIOL	1.50175.7075	5 µm	125 mm	3 mm	1 piece
LiChrospher® 100 DIOL	1.50177.7075	5 µm	250 mm	3 mm	1 piece
LiChrospher® 100 DIOL	1.50960.0001	5 µm	4 mm	4 mm	10 pieces
LiChrospher® 100 DIOL	1.50172.7075	5 µm	25 mm	4 mm	1 piece
LiChrospher® 100 DIOL	1.50302.7075	5 µm	30 mm	4 mm	1 piece
LiChrospher® 100 DIOL	1.50826.0001	5 µm	125 mm	4 mm	1 piece
LiChrospher® 100 DIOL	1.50836.0001	5 µm	250 mm	4 mm	1 piece

The LiChroCART® columns (125 and 250 mm length) in the list above (4 mm i.d.) require part number 1.51486.0001. manu-CART® cartridge column holder, which can be used to hold one cartridge column with or without a 4–4 mm guard column. Additional dimensions available as customized packings see page 366.

LiChrospher® Si 60 and Si 100

LiChrospher® Si 60 and Si 100 are versatile HPLC sorbents based on spherical silica particles providing polar properties and to be used for normal phase chromatography.

Specifications	LiChrospher® Si 60	LiChrospher® Si 100
Sorbent characteristics	Particles of silica	Particles of silica
Particle shape	spherical	spherical
Particle size	5; 10 µm	5; 10 µm
Pore size	60 Å (60 nm)	100 Å (10 nm)
Pore volume	0.85 mL/g	1.25 mL/g
Specific surface area	700 m ² /g	400 m ² /g
Efficiency	55,000 N/m; 20,000 N/m	55,000 N/m; 20,000 N/m
pH range	pH 2-7.5	pH 2-7.5
Shipping eluent	n-Heptane	n-Heptane

- ▶ **Purospher® STAR**
Si (Silica) and NH₂
(Amino-phase)
page 289
- ▶ **Superspher®**
Silica carrier for highly
efficient separations
page 308
- ▶ **LiChrospher®**
Silica carrier for constant
top-rate results
page 312
- ▶ **LiChrosorb®**
Irregular shaped silica
sorbent
page 342
- ▶ **Customized packings**
Always the right column
page 366

Accessories for particulate HPLC columns:

- ▶ **manu-CART® cartridge holder** for LiChroCART® cartridges
page 370
- ▶ **LiChroCART® cartridge**
Different lengths, different internal diameter
page 373
- ▶ **Standardized silica gels**
page 406

Ordering information – LiChrospher® Si 60, sorbents

Product	Ordering No.	Particle size	Package	Quantity
LiChrospher® Si 60	1.19640.0010	5 µm	Glass	10 g
LiChrospher® Si 60	1.19640.0100	5 µm	Glass	100 g



Ordering information – LiChrospher® Si 60 and Si 100, stainless steel columns Hibar® RT

Product	Ordering No.	Particle size	Dimension length	Dimension i.d.	Contents of one package
LiChrospher® Si 60	1.50181.7109	5 µm	125 mm	4 mm	1 piece
LiChrospher® Si 60	1.50182.7109	5 µm	250 mm	4 mm	1 piece
LiChrospher® Si 60	1.50013.7109	5 µm	100 mm	4.6 mm	1 piece
LiChrospher® Si 60	1.50012.7109	5 µm	125 mm	4.6 mm	1 piece
LiChrospher® Si 60	1.50009.7109	5 µm	150 mm	4.6 mm	1 piece
LiChrospher® Si 60	1.00424.7109	5 µm	250 mm	4.6 mm	1 piece
LiChrospher® Si 60	1.50183.7109	5 µm	250 mm	10 mm	1 piece
LiChrospher® Si 60	1.50009.7104	10 µm	150 mm	4.6 mm	1 piece
LiChrospher® Si 100	1.50316.0001	5 µm	250 mm	4 mm	1 piece
LiChrospher® Si 100	1.50182.7101	10 µm	250 mm	4 mm	1 piece
LiChrospher® Si 100	1.00424.7101	10 µm	250 mm	4.6 mm	1 piece

The Hibar® columns are complete with endfittings. When using a guard column with a Hibar® column, we recommend part number 1.51487.0001 guard column cartridge holder for 4–4 mm guard column cartridges LiChroCART®. Additional dimensions available as customized packings see page 366.

Ordering information – LiChrospher® Si 60, stainless steel cartridges LiChroCART®

Product	Ordering No.	Particle size	Dimension length	Dimension i.d.	Contents of one package
LiChrospher® Si 60	1.50195.7109	5 µm	125 mm	2 mm	1 piece
LiChrospher® Si 60	1.50190.7109	5 µm	250 mm	2 mm	1 piece
LiChrospher® Si 60	1.50177.7109	5 µm	250 mm	3 mm	1 piece
LiChrospher® Si 60	1.50955.0001	5 µm	4 mm	4 mm	10 pieces
LiChrospher® Si 60	1.50928.0001	5 µm	25 mm	4 mm	3 pieces
LiChrospher® Si 60	1.50171.7109	5 µm	75 mm	4 mm	1 piece
LiChrospher® Si 60	1.50820.0001	5 µm	125 mm	4 mm	1 piece
LiChrospher® Si 60	1.50830.0001	5 µm	250 mm	4 mm	1 piece
LiChrospher® Si 60	1.51448.7109	5 µm	100 mm	4.6 mm	1 piece
LiChrospher® Si 60	1.51442.7109	5 µm	125 mm	4.6 mm	1 piece
LiChrospher® Si 60	1.51432.7109	5 µm	150 mm	4.6 mm	1 piece
LiChrospher® Si 60	1.51431.7109	5 µm	250 mm	4.6 mm	1 piece
LiChrospher® Si 60	1.50179.7109	5 µm	250 mm	10 mm	1 piece
LiChrospher® Si 60	1.50840.0001	10 µm	250 mm	4 mm	1 piece
LiChrospher® Si 60	1.50850.0001	10 µm	250 mm	10 mm	1 piece

The LiChroCART® columns (125 and 250 mm length) in the list above (4 mm i.d.) require part number 1.51486.0001 manu-CART® cartridge column holder, which can be used to hold one cartridge column with or without a 4–4 mm guard column. LiChroCART® columns 250–10 mm require part number 1.51419.0001 manu-CART® 10. Additional dimensions available as customized packings see page 366.

LiChrosorb®

Irregular shaped silica sorbent



LiChrosorb® is one of the most successful and reliable packing materials, used in HPLC for more than 25 years and documented in the literature in the form of several thousand applications. **The totally porous irregular particles are finely graded in the 5, 7 and 10 µm range.**

LiChrosorb® packing materials offer the complete program of non-polar derivatives (RP-8, RP-18, RP-select B) polar derivatives (Si 60 and Si 100). In addition to the analytical cartridges and columns, such as LiChroCART® 250-4 or Hibar® RT 250-4, Merck Millipore offers semi-preparative cartridges LiChroCART® 250-10 as well as Hibar® RT columns 250-10, packed on request with various LiChrosorb® packing materials.

Specifications of LiChrosorb® packing materials

Packing material	Characteristics	Spec. surface area S_{BET} [m ² /g]	Pore volume V_p [mL/g]	Particle size d_p [µm]	% C	Surface coverage [µmol/m ²]
LiChrosorb® Si 60	irregular particles of silica medium pore size: 6 nm (60Å)	500	0.75	5, 10	–	–
LiChrosorb® Si 100	irregular particles of silica medium pore size: 10 nm (100Å)	300	1.0	10	–	–
LiChrosorb® RP-8	irregular particles of silica with octyl derivative	300	1.0	5, 10	9.5	3.4
LiChrosorb® RP-18	irregular particles of silica with octadecyl derivative	300	1.0	5, 10	16.2	3.0

Fraction range of LiChrosorb® packing materials

Product	Spec. pore volume [mL/g]	Spec. surface area [m ² /g]	Fractionation range (Polystyrene/THF) [g/mol]
LiChrosorb® Si 40	50 – 4 · 10 ³	0.6	800
LiChrosorb® Si 60	80 – 2 · 10 ⁴	0.7	500
LiChrosorb® Si 100	200 – 4 · 10 ⁴	1.0	300
LiChrosorb® RP-8	100 – 4 · 10 ⁴	1.0	300
LiChrosorb® RP-18	100 – 4 · 10 ⁴	1.0	300

- ▶ Customized packings
Always the right column
page 366

Accessories for particulate HPLC columns:

- ▶ manu-CART® cartridge holder for LiChroCART® cartridges
page 370

- ▶ LiChroCART® cartridge
Different lengths, different internal diameter
page 373

- ▶ Hibar® column
page 375

- ▶ LiChroprep®
page 408

LiChrosorb®

A successful packing material from the start

Ordering information – LiChrosorb® sorbents

Product	Ordering No.	Particle size	Package	Quantity
LiChrosorb® Si 60	1.09387.0100	10 µm	Glass	100 g
LiChrosorb® Si 100	1.09309.0010	10 µm	Glass	10 g
LiChrosorb® RP-8	1.09332.0010	5 µm	Glass	10 g
LiChrosorb® RP-8	1.09318.0010	10 µm	Glass	10 g
LiChrosorb® RP-8	1.09318.0100	10 µm	Glass	100 g
LiChrosorb® RP-18	1.09333.0010	5 µm	Glass	10 g
LiChrosorb® RP-18	1.09334.0010	10 µm	Glass	10 g



Ordering information – LiChrosorb®, stainless steel columns Hibar® RT

Product	Ordering No.	Particle size	Dimension length	Dimension i.d.	Contents of one package
LiChrosorb® Si 60	1.50388.0001	5 µm	250 mm	4 mm	1 piece
LiChrosorb® RP-8	1.50432.0001	5 µm	125 mm	4 mm	1 piece
LiChrosorb® RP-8	1.50332.0001	5 µm	250 mm	4 mm	1 piece
LiChrosorb® RP-8	1.50012.7057	5 µm	125 mm	4.6 mm	1 piece
LiChrosorb® RP-8	1.51903.0001	5 µm	250 mm	4.6 mm	1 piece
LiChrosorb® RP-8	1.50181.7059	10 µm	125 mm	4 mm	1 piece
LiChrosorb® RP-8	1.50318.0001	10 µm	250 mm	4 mm	1 piece
LiChrosorb® RP-8	1.00424.7059	10 µm	250 mm	4.6 mm	1 piece
LiChrosorb® RP-18	1.51901.0001	5 µm	250 mm	3 mm	1 piece
LiChrosorb® RP-18	1.50433.0001	5 µm	125 mm	4 mm	1 piece
LiChrosorb® RP-18	1.50333.0001	5 µm	250 mm	4 mm	1 piece
LiChrosorb® RP-18	1.50009.7052	5 µm	150 mm	4.6 mm	1 piece
LiChrosorb® RP-18	1.51902.0001	5 µm	250 mm	4.6 mm	1 piece
LiChrosorb® RP-18	1.50181.7054	10 µm	125 mm	4 mm	1 piece
LiChrosorb® RP-18	1.50334.0001	10 µm	250 mm	4 mm	1 piece
LiChrosorb® RP-18	1.00424.7054	10 µm	250 mm	4.6 mm	1 piece

The Hibar® columns are complete with endfittings. When using a guard column with a Hibar® column, we recommend part number 1.51487.0001 guard column cartridge holder for 4–4 mm guard column cartridges LiChroCART®. Additional dimensions available as customized packings see page 366.

Ordering information – LiChrosorb®, stainless steel cartridges LiChroCART®

Product	Ordering No.	Particle size	Dimension length	Dimension i.d.	Contents of one package
LiChrosorb® Si 60	1.51343.0001	5 µm	125 mm	4 mm	1 piece
LiChrosorb® Si 60	1.51351.0001	5 µm	250 mm	4 mm	1 piece
LiChrosorb® RP-8	1.51345.0001	5 µm	125 mm	4 mm	1 piece
LiChrosorb® RP-8	1.51353.0001	5 µm	250 mm	4 mm	1 piece
LiChrosorb® RP-8	1.51354.0001	10 µm	250 mm	4 mm	1 piece
LiChrosorb® RP-8	1.51443.7054	10 µm	125 mm	10 mm	1 piece
LiChrosorb® RP-18	1.51349.0001	5 µm	125 mm	4 mm	1 piece
LiChrosorb® RP-18	1.51355.0001	5 µm	250 mm	4 mm	1 piece
LiChrosorb® RP-18	1.51448.7052	5 µm	100 mm	4.6 mm	1 piece
LiChrosorb® RP-18	1.51356.0001	10 µm	250 mm	4 mm	1 piece

The LiChroCART® columns (125 and 250 mm length) in the list above (4 mm i.d.) require part number 1.51486.0001 manu-CART® cartridge column holder, which can be used to hold one cartridge column with or without a 4–4 mm guard column. LiChroCART® columns 250–10 mm require part number 1.51419.0001 manu-CART® 10. Additional dimensions available as customized packings see page 366.

Aluspher®

Alkaline stable HPLC separations

Due to its stability, alumina, together with alkaline eluents, has enabled new applications to be found for HPLC. Advanced formulation techniques permit the production of spherical alumina particles as a base for Aluspher® 100 RP-select B.

Aluspher® 100 RP-select B is ideal for use with basic eluents, as ionization of basic compounds is suppressed and peak-tailing is avoided. Due to its stability in the range of pH 2-12, Aluspher® 100 RP-select B permits the use of basic eluents such as NaOH for the separation of neutral, basic and acidic compounds.



Specifications of Aluspher® 100 RP-select B

Sorbent characteristics	Alumina particles, coated with polybutadiene (PBD)
Particle shape	spherical
Particle size	5 µm
Pore size	100 Å (10 nm)
Specific surface area	170 m ² /g
Efficiency	55,000 N/m
pH range	pH 2-12
Shipping eluent	Acetonitrile/Water



▶ **LiChrospher® 60 RP-select B** Excellent separations even with basic compounds
page 329

▶ **Customized packings** Always the right column
page 366

Accessories for particulate HPLC columns:

▶ **manu-CART® cartridge holder** for LiChroCART® cartridges
page 370

▶ **LiChroCART® cartridge** Different lengths, different internal diameter
page 373

▶ **Aluminium oxide** for preparative chromatography
page 404

Aluspher® RP-select B

A stable reversed phase stationary phase optimized for applications up to pH 12

Ordering information – Aluspher® 100 RP-select B, stainless steel columns Hibar®

Product	Ordering No.	Particle size	Dimension length	Dimension i.d.	Contents of one package
Aluspher® 100 RP-select B	1.50182.7002	5 µm	250 mm	4 mm	1 piece

The Hibar® columns are complete with endfittings. When using a guard column with a Hibar® column, we recommend part number 1.51487.0001 guard column cartridge holder for 4–4 mm guard column cartridges LiChroCART®. Additional dimensions available as customized packings see page 366.

Ordering information – Aluspher® 100 RP-select B, stainless steel cartridges LiChroCART®

Product	Ordering No.	Particle size	Dimension length	Dimension i.d.	Contents of one package
Aluspher® 100 RP-select B	1.51311.0001	5 µm	4 mm	4 mm	10 pieces
Aluspher® 100 RP-select B	1.51315.0001	5 µm	125 mm	4 mm	1 piece
Aluspher® 100 RP-select B	1.51318.0001	5 µm	250 mm	4 mm	1 piece

The LiChroCART® columns (125, 150 and 250 mm length) in the list above (4.6 mm i.d.) require part number 1.51486.0001 manu-CART® cartridge column holder, which can be used to hold one cartridge column with or without a 4–4 mm guard column. Additional dimensions available as customized packings see page 366.

Separation examples on Aluspher® 100 RP-select B

Amphetamine compounds

Column	LiChroCART® 250-4 Aluspher® 100 RP-select B, 5 µm
Mobile phase	Methanol/0.025 M NaOH 25/75 (v/v)
Flow rate	1.0 mL/min
Detection	UV 215 nm
Temperature	Room temperature
Sample	1. Amphetamine 2. p-Methoxyamphetamine (PMA) 3. Methylenedioxyamphetamine (MDA) 4. Methamphetamine 5. Methylenedioxymethamphetamine (MDMA) 6. Ethylamphetamine 7. Methylenedioxyethylamphetamine (MDEA)

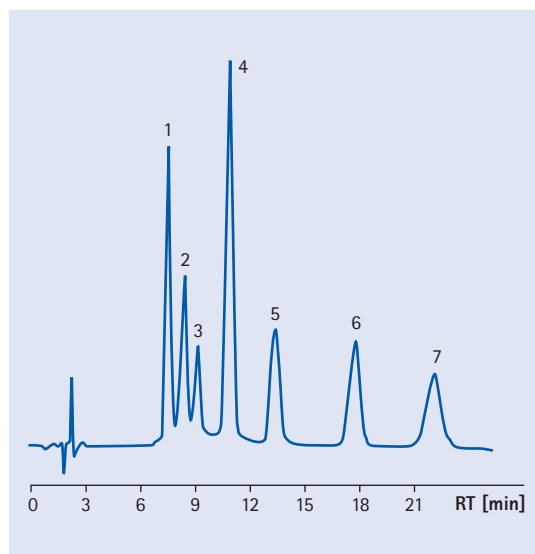

Pharmaceuticals with non-buffered eluent

Column	LiChroCART® 250-4 Aluspher® 100 RP-select B, 5 µm
Mobile phase	Acetonitrile/Water 35/65 (v/v)
Flow rate	1.0 mL/min
Detection	UV 220 nm
Temperature	Room temperature
Sample	1. Levamisole 2. 5-Methyl-5-phenyldantoin (MPH) 3. 5-Phenyl-5-(2-pyridyl)-hydantoin (PPH) 4. 5-(p-Methylphenyl)-5-phenylhydantoin (MPH) 5. Diazepam

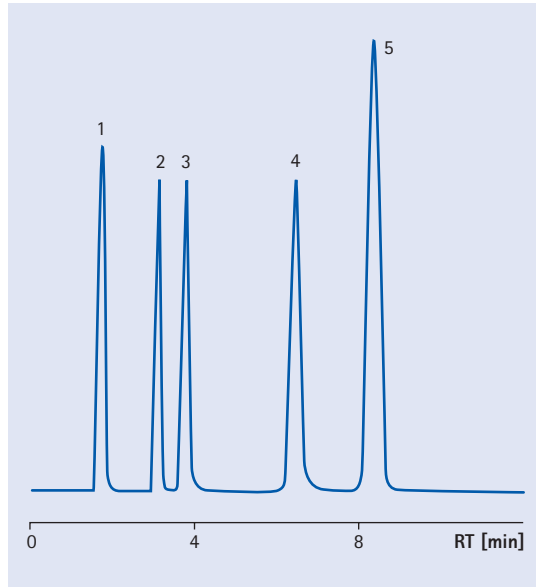

Beta-Blockers with alkaline eluents

Column	LiChroCART® 250-4 Aluspher® 100 RP-select B, 5 µm
Mobile phase	Methanol/0.025 M NaOH 50/50 (v/v)
Flow rate	1.0 mL/min
Detection	UV 220 nm
Temperature	Room temperature
Sample	1. Sotalol 2. Atenolol 3. Metoprolol

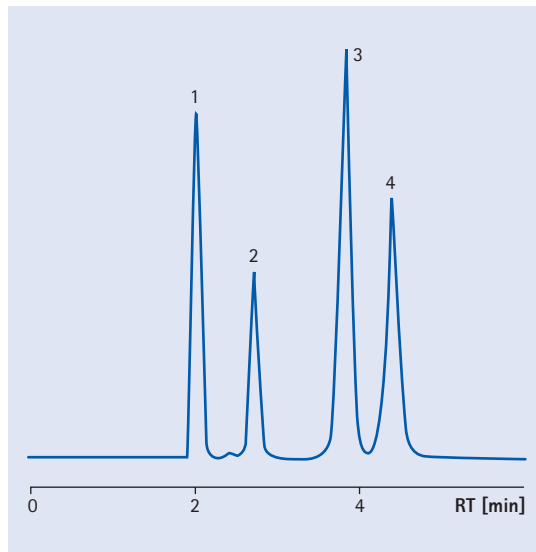

SeQuant® HILIC

ZIC®-HILIC, ZIC®-cHILIC and ZIC®-pHILIC are the ideal columns for all classes of polar hydrophilic compounds

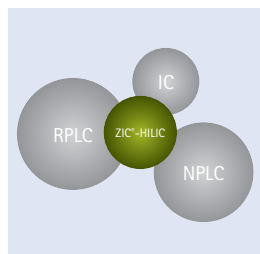

Your ideal choice for separation of all types of polar and hydrophilic compounds are the SeQuant® HILIC HPLC columns. Reproducible retention for compounds that have proved difficult to separate on reversed-phase HPLC columns is ensured by the high-performance zwitterionic sorbents in these columns.

Straightforward separation of compounds such as acids and bases, anions and cations, carbohydrates, metabolites, metal complexes, amino acids, peptides, protein digests and oligonucleotides can therefore be achieved with a selectivity complementary to reversed-phase columns. Enhanced LC-MS sensitivity is an additional benefit of using these columns.

Columns are available in a wide range of formats from capillary to semi-preparative dimensions, and with several different particles sizes and pore sizes.

SeQuant® HILIC benefits

- Improved separation of hydrophilic polar compounds
- Selectivity complementary to reversed phase
- Optimal design for HPLC and LC-MS
- Easy method development
- Excellent stability



Specification of SeQuant® HILIC sorbents

	Characteristics	Particle size [μm]	Surface area [m ² /g]	pH stability	Max temp [°C]
ZIC®-HILIC 100 Å	Densely bonded zwitterionic sulfobetaine on high-purity spherical silica particles	3.5	180	2-8	70
ZIC®-HILIC 200 Å	Densely bonded zwitterionic sulfobetaine on high-purity spherical silica particles	3.5, 5	130	2-8	70
ZIC®-cHILIC 100 Å	Densely bonded zwitterionic phosphorylcholine on high-purity spherical silica particles	3	-	2-8	70
ZIC®-pHILIC	Densely bonded zwitterionic sulfobetaine on spherical polymer particles	5	-	2-12	50

▶ **SeQuant® ZIC®-HILIC**
High-performance columns for hydrophilic compounds

page 354

▶ **SeQuant® ZIC®-cHILIC**
Complementary selectivity for polar hydrophilic compounds

page 359

▶ **SeQuant® ZIC®-pHILIC**
Polymeric columns with extended pH stability for demanding separations of hydrophilic compounds

page 362

What is HILIC?

HILIC or Hydrophilic Interaction Liquid Chromatography is a straightforward chromatographic technique for separation of many types of polar and hydrophilic compounds. To put it simple one can say that HILIC is a normal-phase (NPLC) type of separation but uses reversed-phase (RPLC) type eluents.

In HILIC one uses:

- A column with a hydrophilic stationary phase
- An eluent with water, buffer and a high concentration of water-miscible organic solvent.

A typical HILIC application uses an eluent with 50 – 95 % organic solvent in an aqueous buffer that has a high solubility in the solvent, for example acetonitrile in ammonium acetate. The elution order in HILIC is roughly the opposite of that in RPLC and retention increases with hydrophilicity and charge of the analyte. This enables straightforward separation of compounds that would otherwise elute in the void volume on RPLC columns.

Schematic illustration of retention processes on the ZIC®-HILIC stationary phase

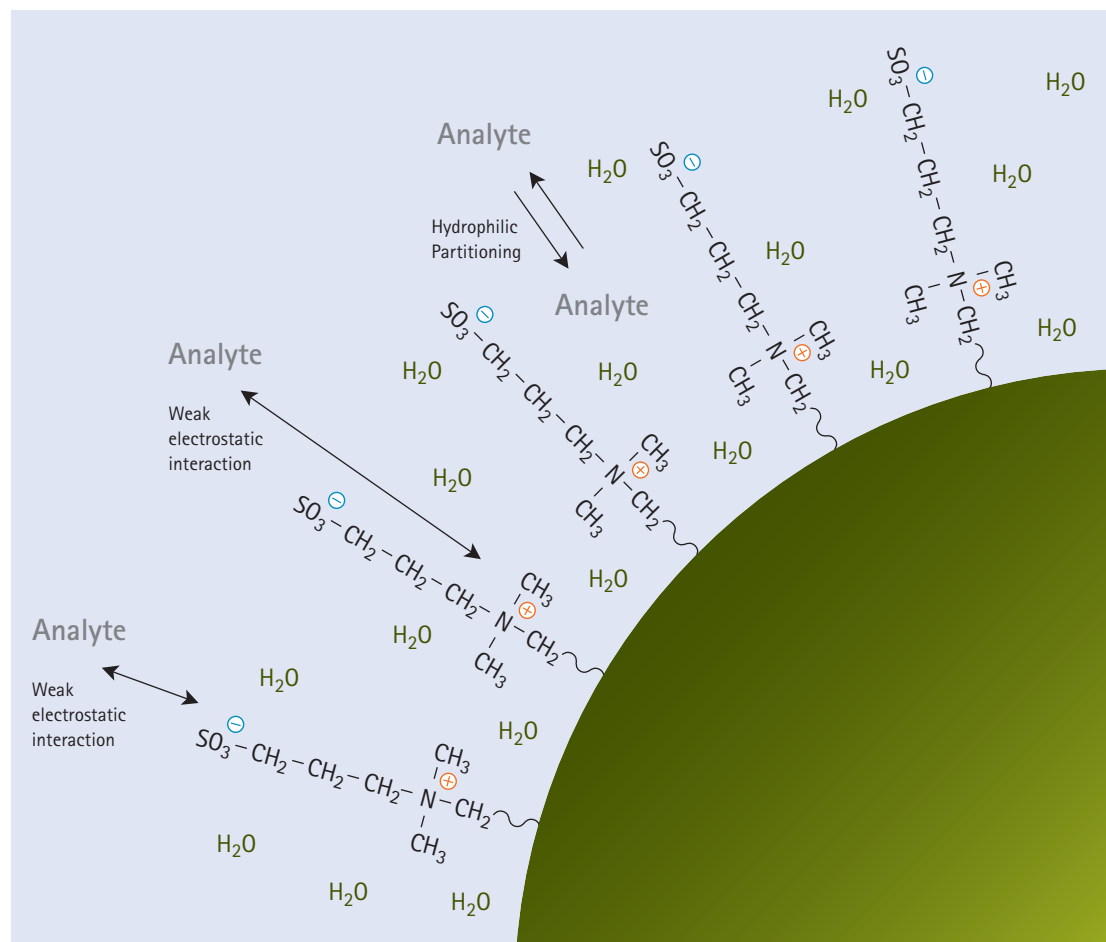



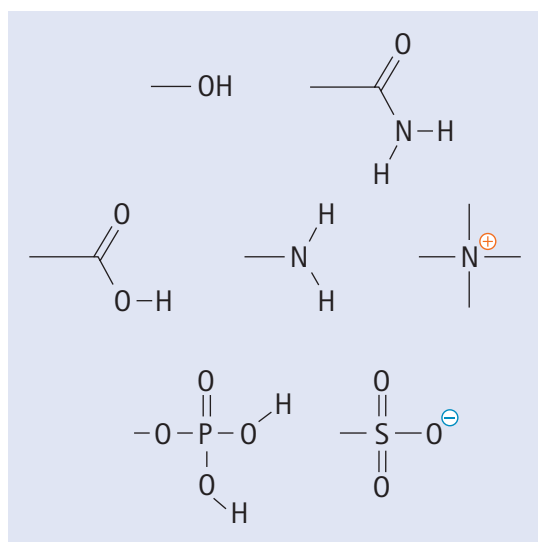

For all classes of polar and hydrophilic compounds

With the SeQuant® HILIC columns, separation of polar and hydrophilic compounds is straightforward. The selectivity is complementary to reversed phase and therefore suitable for a wide variety of molecules containing hydrophilic or ionizable functional groups. This includes compounds such as carbohydrates, metabolites, acids and bases, organic and inorganic ions, metal complexes, amino acids, peptides, protein digests, plant and cell extracts, plus much more. These compounds are normally characterized by a small or negative log P value* and have poor retention on reversed-phase columns.

The high hydrophilicity and high retention per surface area of the SeQuant® HILIC columns enable separation of a very wide range of polar hydrophilic compounds.

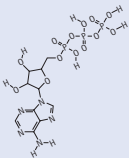
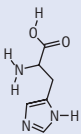
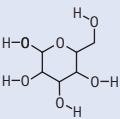

Examples of hydrophilic functional groups

SeQuant® -HILIC range										
ATP	Histidine	Glucose	Uracil	Pyridine	Toluene	Hexane				
										
-6	-5	-4	-3	-2	-1	0	1	2	3	Analyte log P*

Examples of polar and hydrophilic compounds with different log P values* that can be separated with SeQuant® HILIC columns. In contrast, two compounds that are too hydrophobic to be retained (toluene and hexane) are also displayed.

*Log P is the octanol-water partition coefficient.

Simplified method development

SeQuant® HILIC columns have densely bonded stationary phases consisting of highly polar, permanent zwitterionic functional groups. Separation selectivity is enhanced by the truly 1:1 zwitterion charge balance in close proximity.

The highly hydrophilic structures are very good at establishing an immobilized water-rich layer within the stationary phase – a feature that is fundamentally important for all HILIC separations. Separation optimization during method development with SeQuant® HILIC columns is simplified by the low requirements for buffer concentrations due to the inherent weak ionic interactions of the zwitterionic columns. This is advantageous for many detection principles, including mass spectrometry (MS).

The column pair of ZIC®-HILIC and ZIC®-cHILIC can facilitate your method development since they have complementary zwitterionic functional groups that provide different weak ionic interactions to charged molecules. This allows for selectively changing retention for charged molecules while keeping similar elution pattern for neutral compounds by change of column.

SeQuant® ZIC®-cHILIC

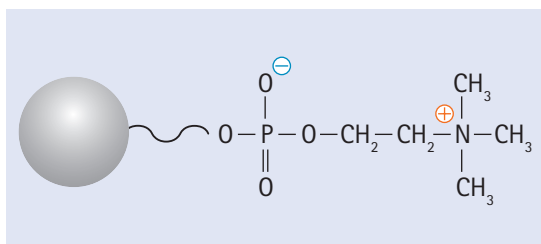

Functional group of ZIC®-cHILIC; phosphorylcholine

SeQuant® ZIC®-HILIC and ZIC®-pHILIC

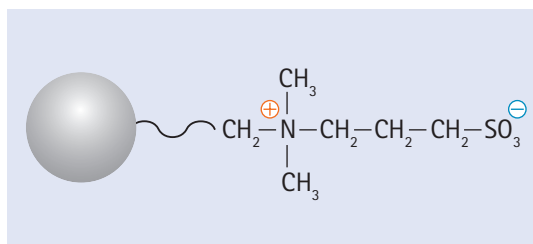

Functional group of ZIC®-HILIC and ZIC®-pHILIC; sulfobetaine

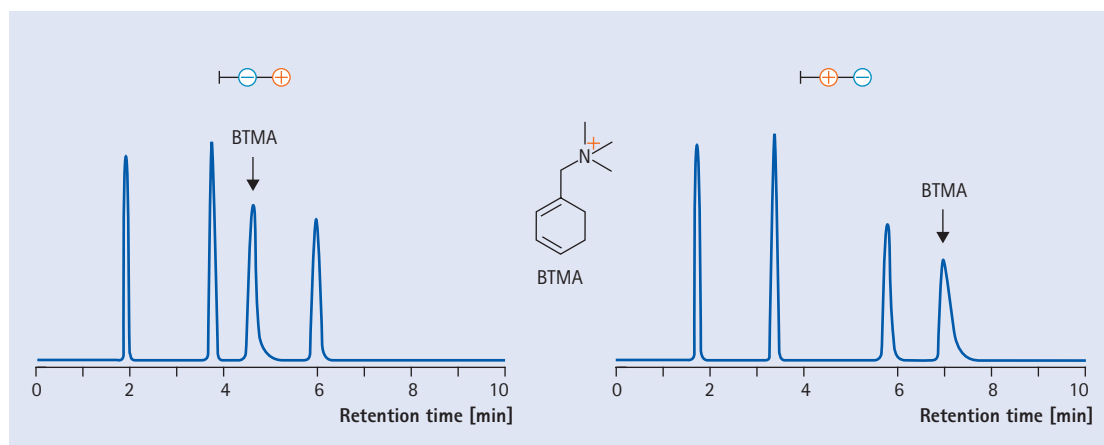

Isocratic separations of the positively charged benzyltrimethylamine (BTMA, peaks indicated with arrows) and the neutral toluene (void marker), uracil and cytosine on ZIC®-cHILIC (left) and ZIC®-HILIC (right) illustrating differences and similarities in selectivity caused by the different charge orientation of the zwitterionic functional groups (see illustrations). Column dimensions were 100 x 4.6 mm, particles size 3 or 3.5 μm, and pore size 100 Å. Eluent was 80 : 20 acetonitrile/ 25 mM aqueous ammonium acetate pH 6.8 pumped at 0.5 mL/min at 23°C. Detection by UV absorption at 254 nm.

Enhanced control of selectivity with pH

Eluent pH can be a powerful tool to optimize selectivity on SeQuant® HILIC columns. Especially so since the bonded pH-independent permanent zwitterions ensures that only the analytes, and not the column, is affected by changes in buffer pH.

With the polymer-based ZIC®-pHILIC column, this effect can be used to solve the most difficult separations by ionizing weak acids such as phenolic groups.

The chromatograms show isocratic separations of gentisic acid, protocatechuic acid and isophthalic acid on a ZIC®-pHILIC column. The pH-increase also results in higher retention and improved peak shape for these analytes.

Separation of gentisic acid, protocatechuic acid, and isophthalic acid on a ZIC®-pHILIC column

Column	ZIC®-pHILIC column
Mobile phase	75:25 Acetonitrile / aqueous buffer pumped at 0.5 mL/min
Buffer salt	Ammonium acetate, 17 mM, pH 6.8 or Ammonium carbonate, 17 mM, pH 9.6

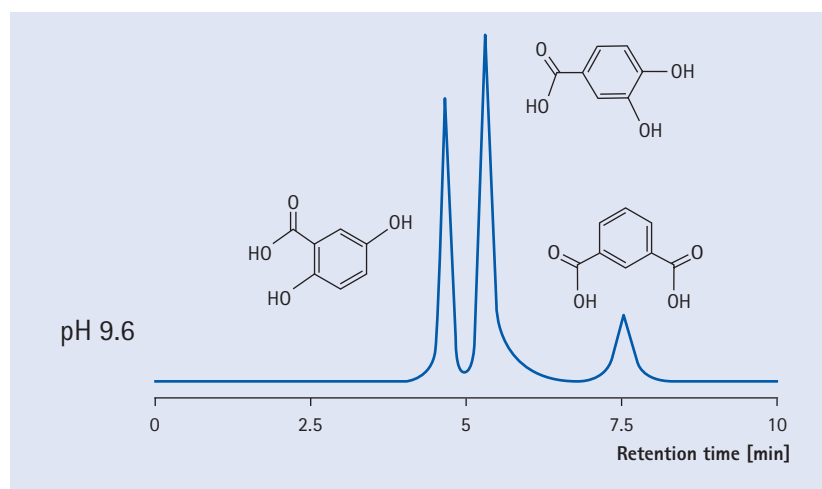
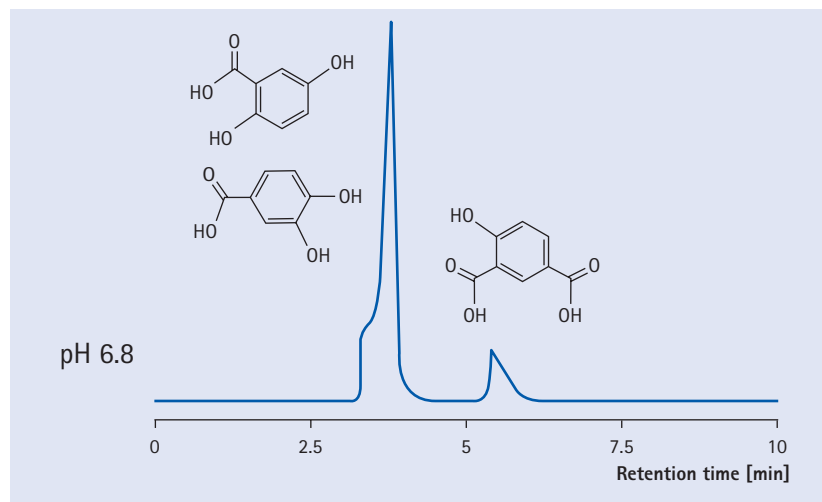

Maximum LC-MS compatibility

SeQuant® HILIC columns excel in stability and low bleed. These features make them particularly suitable for LC-MS applications where high background can lead to signal suppression and interference with quantitative measurements while also increasing instrument wear. Their high stability makes these high-performance HILIC columns also attractive for traditional HPLC applications.

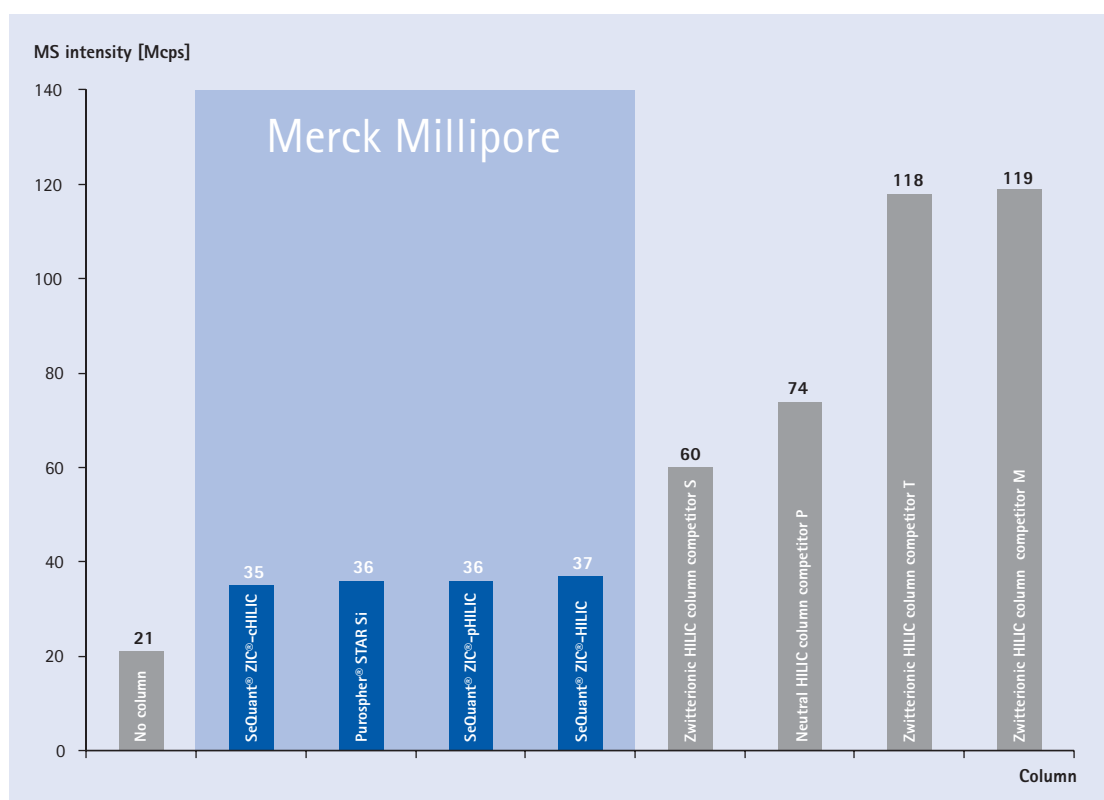

Mass spectrometry intensity data from ESI+ with single quadrupole MS measured as total ion current for 20–2000 m/z. Columns were 100 x 2.1 mm operated at 50°C with a flow rate of 0.1 mL/min. Eluent was 80 : 20 acetonitrile/25 mM aqueous ammonium acetate pH 6.8. Average of 3 measurements, each during 6 minutes. All columns were allowed to equilibrate 1–2 hours until baseline had stabilized before measurement.

Application collections with HILIC methods

Download application examples where the SeQuant® HILIC columns are solving a range of different separation and analysis problems in different areas.

www.merckmillipore.com/application-collections



SeQuant[®] ZIC[®]-HILIC

High-performance columns for hydrophilic compounds

Ordering information – SeQuant[®] ZIC[®]-HILIC analytical PEEK columns

Product	Ordering No.	Particle size	Porosity	Dimension length	Dimension i.d.	Contents of one package
ZIC [®] -HILIC PEEK HPLC column	1.50439.0001	3.5 µm	100 Å	20 mm	2.1 mm	1 piece
ZIC [®] -HILIC PEEK HPLC column	1.50440.0001	3.5 µm	100 Å	50 mm	2.1 mm	1 piece
ZIC [®] -HILIC PEEK HPLC column	1.50441.0001	3.5 µm	100 Å	100 mm	2.1 mm	1 piece
ZIC [®] -HILIC PEEK HPLC column	1.50442.0001	3.5 µm	100 Å	150 mm	2.1 mm	1 piece
ZIC [®] -HILIC PEEK HPLC column	1.50443.0001	3.5 µm	100 Å	250 mm	2.1 mm	1 piece
ZIC [®] -HILIC PEEK HPLC column	1.50444.0001	3.5 µm	100 Å	150 mm	4.6 mm	1 piece
ZIC [®] -HILIC PEEK HPLC column	1.50445.0001	3.5 µm	200 Å	50 mm	2.1 mm	1 piece
ZIC [®] -HILIC PEEK HPLC column	1.50447.0001	3.5 µm	200 Å	100 mm	2.1 mm	1 piece
ZIC [®] -HILIC PEEK HPLC column	1.50448.0001	3.5 µm	200 Å	150 mm	2.1 mm	1 piece
ZIC [®] -HILIC PEEK HPLC column	1.50446.0001	3.5 µm	200 Å	50 mm	4.6 mm	1 piece
ZIC [®] -HILIC PEEK HPLC column	1.50449.0001	3.5 µm	200 Å	150 mm	4.6 mm	1 piece
ZIC [®] -HILIC PEEK HPLC column	1.50450.0001	5 µm	200 Å	50 mm	2.1 mm	1 piece
ZIC [®] -HILIC PEEK HPLC column	1.50452.0001	5 µm	200 Å	100 mm	2.1 mm	1 piece
ZIC [®] -HILIC PEEK HPLC column	1.50454.0001	5 µm	200 Å	150 mm	2.1 mm	1 piece
ZIC [®] -HILIC PEEK validation kit (3 columns of 3 different sorbent batches)	1.50454.1003	5 µm	200 Å	150 mm	2.1 mm	3 pieces
ZIC [®] -HILIC PEEK HPLC column	1.50457.0001	5 µm	200 Å	250 mm	2.1 mm	1 piece
ZIC [®] -HILIC PEEK HPLC column	1.50451.0001	5 µm	200 Å	50 mm	4.6 mm	1 piece
ZIC [®] -HILIC PEEK HPLC column	1.50453.0001	5 µm	200 Å	100 mm	4.6 mm	1 piece
ZIC [®] -HILIC PEEK HPLC column	1.50455.0001	5 µm	200 Å	150 mm	4.6 mm	1 piece
ZIC [®] -HILIC PEEK validation kit (3 columns of 3 different sorbent batches)	1.50455.1003	5 µm	200 Å	150 mm	4.6 mm	3 pieces
ZIC [®] -HILIC PEEK HPLC column	1.50458.0001	5 µm	200 Å	250 mm	4.6 mm	1 piece
ZIC [®] -HILIC PEEK fitting guard column (5-pak)	1.50434.0001	5 µm	200 Å	14 mm	1 mm	5 pieces
ZIC [®] -HILIC guard column (1-pak)	1.50435.0001	5 µm	200 Å	20 mm	2.1 mm	1 piece
ZIC [®] -HILIC guard column incl. column coupler	1.50436.0001	5 µm	200 Å	20 mm	2.1 mm	3 pieces



Ordering information – SeQuant® ZIC®-HILIC Nano, Capillary and Microbore columns

Product	Ordering No.	Particle size	Porosity	Dimension length	Dimension i.d.	Contents of one package
ZIC®-HILIC Microbore column	1.50487.0001	3.5 µm	100 Å	150 mm	1 mm	1 piece
ZIC®-HILIC Microbore column	1.50478.0001	3.5 µm	200 Å	30 mm	1 mm	1 piece
ZIC®-HILIC Microbore column	1.50480.0001	3.5 µm	200 Å	150 mm	1 mm	1 piece
ZIC®-HILIC Nano column	1.50466.0001	3.5 µm	200 Å	100 mm	100 µm	1 piece
ZIC®-HILIC Capillary column	1.50489.0001	3.5 µm	200 Å	30 mm	300 µm	1 piece
ZIC®-HILIC Capillary column	1.50479.0001	3.5 µm	200 Å	150 mm	300 µm	1 piece
ZIC®-HILIC Microbore column	1.50482.0001	5 µm	200 Å	150 mm	1 mm	1 piece
ZIC®-HILIC Nano column	1.50465.0001	5 µm	200 Å	150 mm	75 µm	1 piece
ZIC®-HILIC Capillary column	1.50491.0001	5 µm	200 Å	30 mm	300 µm	1 piece
ZIC®-HILIC Capillary column	1.50481.0001	5 µm	200 Å	150 mm	300 µm	1 piece
ZIC®-HILIC guard column (5-pak)	1.50492.0001	5 µm	200 Å	5 mm	300 µm	5 pieces
ZIC®-HILIC guard column (5-pak)	1.50490.0001	5 µm	200 Å	5 mm	1 mm	5 pieces

Ordering information – SeQuant® ZIC®-HILIC semi-preparative columns

Product	Ordering No.	Particle size	Porosity	Dimension length	Dimension i.d.	Contents of one package
ZIC®-HILIC PEEK HPLC column	1.50456.0001	5 µm	200 Å	150 mm	7.5 mm	1 piece
ZIC®-HILIC Stainless steel column	1.50495.0001	5 µm	200 Å	50 mm	10 mm	1 piece
ZIC®-HILIC Stainless steel column	1.50493.0001	5 µm	200 Å	150 mm	10 mm	1 piece
ZIC®-HILIC Stainless steel column	1.50494.0001	5 µm	200 Å	250 mm	10 mm	1 piece
ZIC®-HILIC Stainless steel column	1.50496.0001	5 µm	200 Å	50 mm	21.2 mm	1 piece
ZIC®-HILIC Stainless steel column	1.50497.0001	5 µm	200 Å	150 mm	21.2 mm	1 piece
ZIC®-HILIC Stainless steel column	1.50671.0001	5 µm	200 Å	250 mm	21.2 mm	1 piece

For more information please visit www.merckmillipore.com/zichilic



Separation examples on ZIC®-HILIC

Separation of cyanuric acid and melamine food contaminants

Column	ZIC®-HILIC 150 x 2.1 mm, 5 µm, 200 Å [Ord. No. 1.50454.0001]			
Mobile phase	A: 95 % acetonitrile in 0.1 % aqueous formic acid B: 50 % acetonitrile in 20 mM aqueous ammonium formate			
Gradient	Time [min]	% A	% B	Flow rate [mL/min]
	0	100	0	0.4
	4.2	100	0	0.4
	8.0	65	35	0.4
	8.5	65	35	0.4
	9.0	25	75	0.4
	11.0	25	75	0.4
	11.2	100	0	0.6
	13.0	100	0	0.6
	14.0	100	0	0.4
Detection	MS/MS, -ESI and +ESI			
Temperature	30°C			
Injection volume	5 µL			
Sample	Standard in mobile phase (7 ng/mL) equivalent to 1 µg/g			
<i>Courtesy of</i>	<i>David N. Heller, FDA Center for Veterinary Medicine, Laurel, MD 20708 USA</i>			

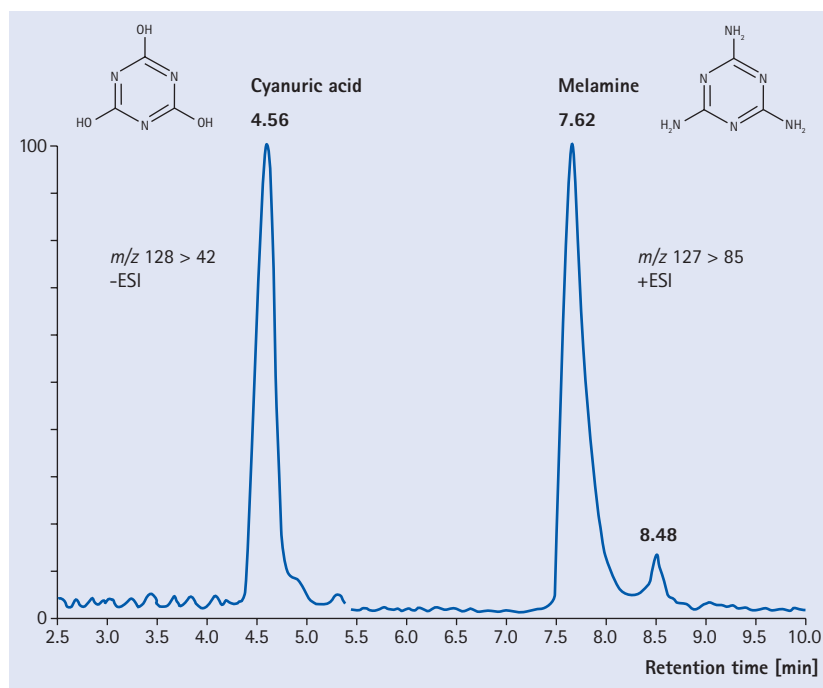

Reference *David N. Heller and Cristina B. Nochetto, Rapid Commun. Mass Spectrom., 22 (2008) 3624–3632. DOI: 10.1002/rcm.3779*

Separation of chlormequat and mepiquat pesticides

Column	ZIC®-HILIC 100 x 2.1 mm, 3.5 µm, 200 Å [Ord. No. 1.50447.0001]			
Mobile phase	80 % Acetonitrile and 20 % Ammonium Acetate 25 mM (v/v)			
Flow rate	0.2 mL/min			
Detection	Electrospray-MS in positive mode (ESI+), Single ion monitoring (SIM) at m/z 114 and 122			
Injection volume	20 µL			
Sample	Chlormequat and Mepiquat standard in mobile phase			
<i>Courtesy of</i>	<i>Dr.-Ing. Ludmila Havlik, Chemisches Labor Dr. Wirts + Partner, Hannover, Germany, www.wirts.de</i>			

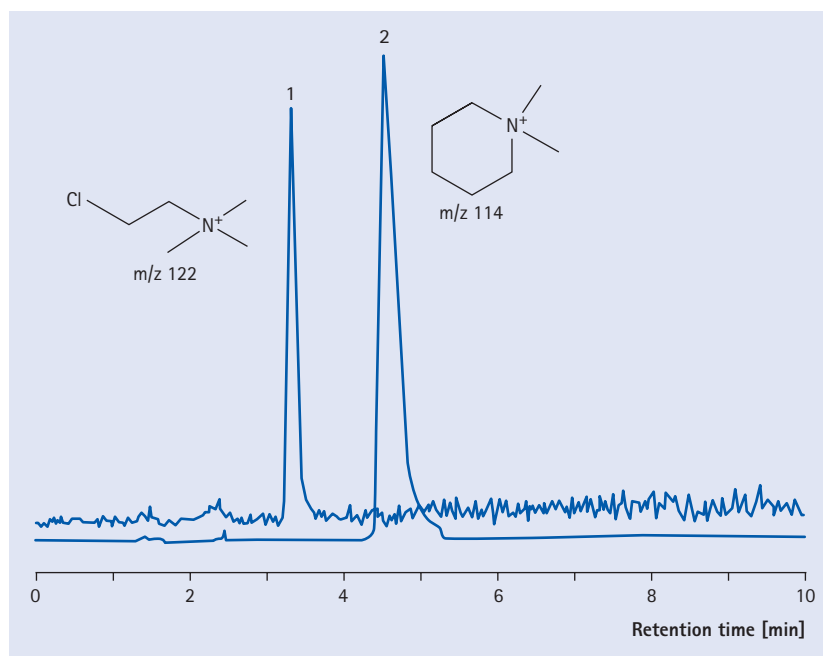

Separation of inorganic anions and cations

Column	ZIC®-HILIC 150 x 2.1 mm, 3.5 µm, 100 Å [Ord. No. 1.50442.0001]		
Mobile phase	A: Acetonitrile B: 20 mM Ammonium Formate, pH 3		
Gradient	Time [min]	% A	% B
	0.0	80	20
	3.0	80	20
	10.0	20	80
	13.0	20	80
	13.1	80	20
	23.0	80	20
Flow rate	0.3 mL/min		
Detection	ELSD, SEDEX 85LT, 40°C, 3.5 bar		
Temperature	40°C		
Injection volume	2 µL		
Sample	1.-8.	LOD [based on S/N=3]	
	1. NO ₃	2.6 mg/L	
	2. Cl	2.3 mg/L	
	3. K	5.1 mg/L	
	4. Na	0.9 mg/L	
	5. PO ₄	15.8 mg/L	
	6. SO ₄	2.4 mg/L	
	7. Mg	0.3 mg/L	
	8. Ca	0.7 mg/L	

Courtesy of *Eric Verette, SEDERE S.A.S, France*

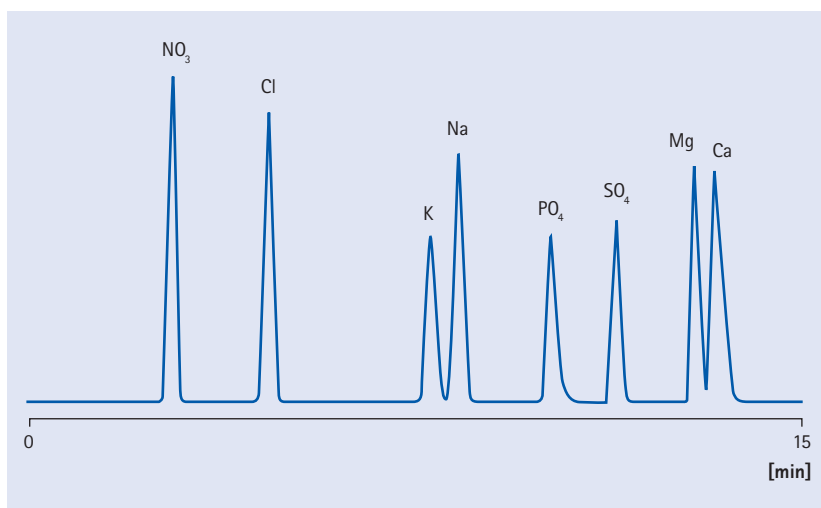

Separation of amino acids

Column	ZIC®-HILIC 150 x 4.6 mm, 3.5 µm, 100 Å [Ord. No. 1.50444.0001]	
Mobile phase	80 % Acetonitrile 20 % Ammonium acetate in water, 50 mM pH adjusted to 4.5 with formic acid	
Flow rate	0.75 mL/min	
Detection	Refractive Index, cell 9 µL, 40°C	
Temperature	40°C	
Injection volume	50 µL	
Sample	1. 2-Amino-5-Hydroxy benzoic acid	100 ppm
	2. Tryptophan	100 ppm
	3. Isoleucine	100 ppm
	4. Methionine	100 ppm
	5. Lysine	100 ppm
	6. Threonine	100 ppm

Courtesy of *Gora Sharangi, Merck India Application Lab*

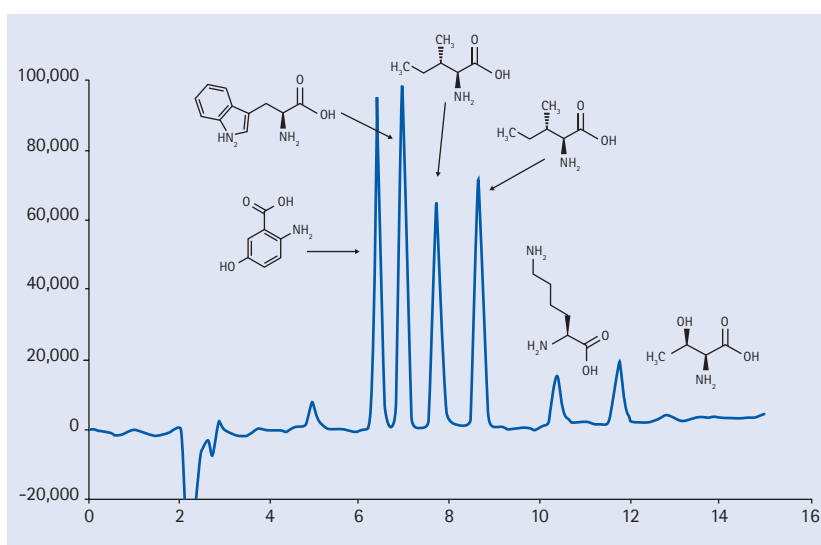

Separation examples on ZIC®-HILIC

Bioanalysis of methyl malonic acid

Column	ZIC®-HILIC 100 x 2.1 mm, 3.5 µm, 100 Å [Ord. No. 1.50441.0001]
Mobile phase	A: 80 % (v/v) acetonitrile B: 20 % (v/v) 100 mM NH ₄ Ac buffer pH 4.5
Flow rate	0.4 mL/min
Detection	MS-ESI- with SIM at 117.2 m/z Drying-gas flow rate 10 L/min Drying-gas temperature 300°C Capillary voltage 3.0 kV
Injection volume	4 µL
Sample	Precipitated-treated plasma sample containing 0.137 mol/L MMA
Reference	<i>H-A Lakso, P. Appelblad, J. Schneede Clin. Chem., 54 (2008) 2028 DOI: 10.1373/clinchem.2007.101253</i>

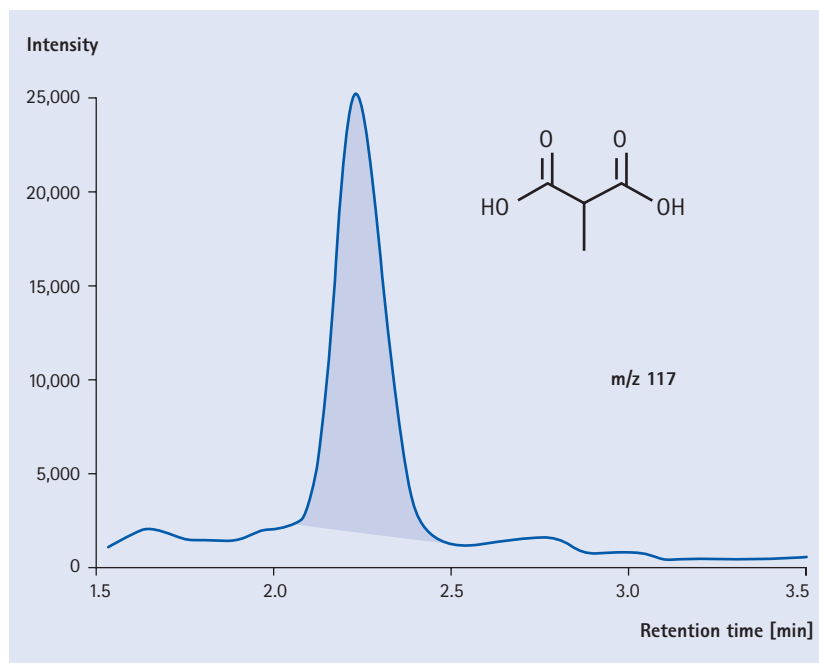

Separation of bovine serum albumin tryptic digest

Column	ZIC®-HILIC 150 x 0.3 mm, 5 µm, 200 Å [Ord. No. 1.50481.0001]
Mobile phase	A: 100 % Acetonitrile with 0.25 % formic acid B: 100 % Milli-Q water with a 0.25 % formic acid
Gradient	Time [min] % A % B 0 90 10 40 10 0
Flow rate	5 µL/min
Detection	MicroMass Ultima-QTOF Needle voltage 3.1 kV Cone voltage 45 V Collision energy 10 V Scan range 400-1800 m/z Cycle time 1.5 s
Injection volume	1 µL
Sample	10 pmole digested sample injected in mobile phase

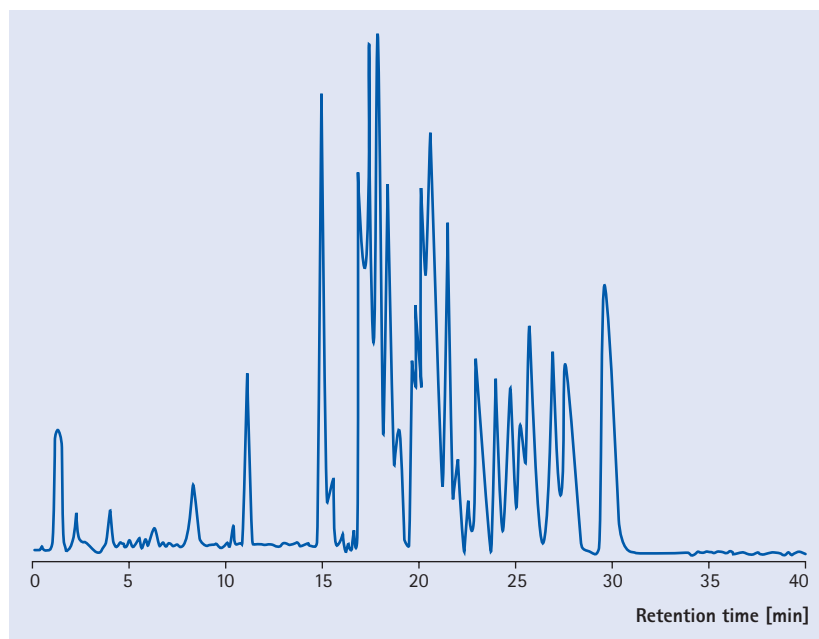

SeQuant[®] ZIC[®]-cHILIC

Complementary selectivity for polar hydrophilic compounds

Ordering information – SeQuant[®] ZIC[®]-cHILIC analytical PEEK columns

Product	Ordering No.	Particle size	Porosity	Dimension length	Dimension i.d.	Column hardware	Contents of one package
ZIC [®] -cHILIC PEEK HPLC column	1.50656.0001	3 µm	100 Å	50 mm	2.1 mm	PEEK	1 piece
ZIC [®] -cHILIC PEEK HPLC column	1.50657.0001	3 µm	100 Å	100 mm	2.1 mm	PEEK	1 piece
ZIC [®] -cHILIC PEEK HPLC column	1.50658.0001	3 µm	100 Å	150 mm	2.1 mm	PEEK	1 piece
ZIC [®] -cHILIC PEEK HPLC column	1.50659.0001	3 µm	100 Å	50 mm	4.6 mm	PEEK	1 piece
ZIC [®] -cHILIC PEEK HPLC column	1.50660.0001	3 µm	100 Å	100 mm	4.6 mm	PEEK	1 piece
ZIC [®] -cHILIC PEEK HPLC column	1.50661.0001	3 µm	100 Å	150 mm	4.6 mm	PEEK	1 piece
ZIC [®] -cHILIC PEEK HPLC column	1.50662.0001	3 µm	100 Å	250 mm	4.6 mm	PEEK	1 piece
ZIC [®] -cHILIC PEEK guard kit incl. column coupler	1.50664.0001	5 µm	100 Å	20 mm	2.1 mm	PEEK	3 pieces

Ordering information – SeQuant[®] ZIC[®]-cHILIC Capillary columns

Product	Ordering No.	Particle size	Porosity	Dimension length	Dimension i.d.	Column hardware	Contents of one package
ZIC [®] -cHILIC Capillary column	1.50669.0001	3 µm	100 Å	150 mm	300 µm	GL-SS	1 piece
ZIC [®] -cHILIC Capillary column	1.50670.0001	3 µm	100 Å	150 mm	1 µm	GL-SS	1 piece
ZIC [®] -cHILIC Capillary guard	1.50665.0001	5 µm	100 Å	5 mm	300 µm	GL-SS	3 pieces
ZIC [®] -cHILIC Capillary guard	1.50666.0001	5 µm	100 Å	5 mm	1 mm	GL-SS	3 pieces

For more information please visit www.merckmillipore.com/zichilic

Separation examples on ZIC®-cHILIC

LC-MS of aminoglycosides

Column	ZIC®-cHILIC 100 x 2.1 mm, 3 µm, 100 Å [Ord. No. 1.50657.0001]		
Mobile phase	A: acetonitrile with 1 % (w/w) formic acid B: 100 mM ammonium acetate with 3 % (w/w) formic acid		
Gradient	Time [min]	% A	% B
	0.0-7.0	50-5	50-95
	7.0-8.0	5	95
	8.0-16.0	50	95-50
			equilibration
Flow rate	0.4 mL/min		
Detection	Shimadzu LCMS 2012 EV, detector voltage: 2.0 kV, heat block and CDL temp: 250°C		
Temperature	50°C		
Injection volume	5 µL		
Diluent	Acetonitrile and Milli-Q water 30:70 (v/v)		
Sample	Solution with 5 µg/mL of streptomycin (STR) and 25 µg/mL of each gentamycin (GEN), paromomycin (PAR), tobramycin (TOB), and neomycin (NEO) in diluted.		
	1. Streptomycin	2.7 min	582 m/z
	2. Gentamycin	4.3 min	464 m/z
	3. Paromomycin	4.9 min	616 m/z
	4. Tobramycin	5.2 min	468 m/z
	5. Neomycin	5.7 min	615 m/z

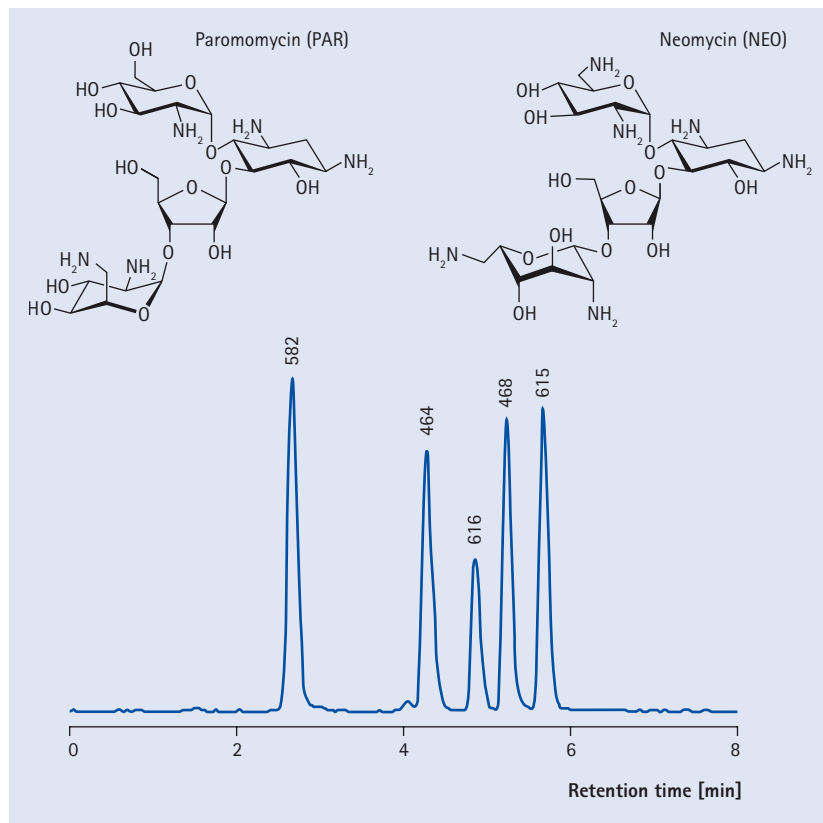

Separation of organic acids

Column	ZIC®-cHILIC 150 x 2.1 mm, 3 µm, 100 Å [Ord. No. 1.50658.0001]	
Mobile phase	75:25 acetonitrile/25 mM potassium phosphate, buffer pH 6.0	
Flow rate	0.3 mL/min	
Detection	UV at 200 nm using a 2.5 µL semi-micro flow-cell. Total system void time was 1.0 min.	
Temperature	30°C	
Injection volume	5 µL	
Sample	Standard mixture containing 10 ppm each of acetic acid/succinic acid/malic acid/tartaric acid/citric acid (diluted in mobile phase/upper trace) and Riesling wine diluted in water 1:10 and then in acetonitrile 1:10 (bottom trace).	
	1. Acetic acid	2.4 min
	2. Succinic acid	3.9 min
	3. Malic acid	5.5 min
	4. Tartaric acid	6.0 min
	5. Citric acid	8.9 min
	* indicates impurities in standards	

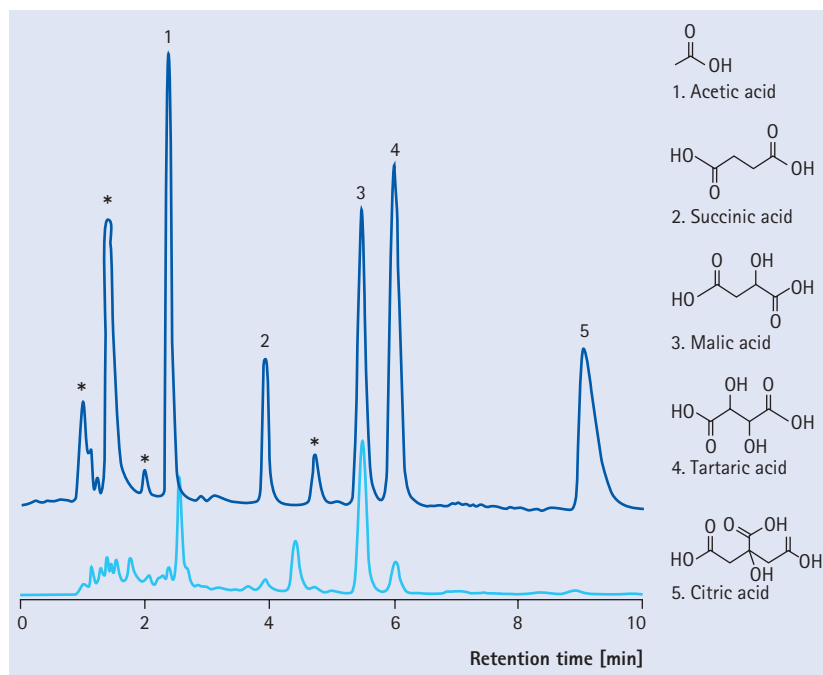

Impurity profiling of metformin

Column	ZIC®-cHILIC 150 x 4.6 mm, 3 µm, 100 Å [Ord. No. 1.50661.0001]
Mobile phase	Dissolve 0.64 g of potassium di-hydrogen phosphate in 1000 mL Milli-Q water. Adjust pH 3.0 with ortho-phosphoric acid and filter. Mix buffer and acetonitrile 15:85 (v/v)
Flow rate	0.8 mL/min
Pressure	43 Bar (624 psi)
Detection	Shimadzu Prominence, R.I.
Vol. detector cell	10 µL
Temperature	40°C (oven), 40°C (detector cell)
Injection volume	10 µL
Diluent	Mix buffer and acetonitrile 20:80 (v/v)
Standard	Dissolve 48 mg each of Sorbitol and Mannitol standard in 10 mL volumetric flask and dilute up to the mark with diluent.
Sample	Dissolve 60 mg of sample in 10 mL volumetric flask and dilute up to the mark with diluent

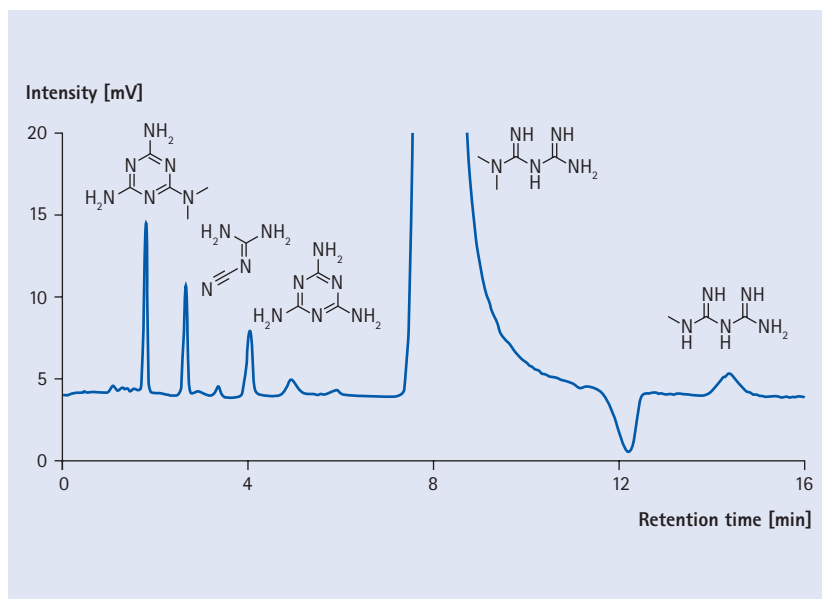

Analysis of excipients

Column	ZIC®-cHILIC 150 x 4.6 mm, 3 µm, 100 Å [Ord. No. 1.50661.0001]
Mobile phase	Buffer: Dissolve 4.62 g of ammonium acetate in 1000 mL water (60 mM).
Flow rate	Adjust buffer a pH 5 using glacial acetic acid. Mix Acetonitrile and Buffer 90:10 (v/v)
Pressure	105 bar (1522 psi)
Detection	Shimadzu LC-10, UV 218 nm
Vol. detector cell	8 µL
Temperature	30°C
Injection volume	5 µL
Diluent	Mobile phase
Sample	5000 ppm metformin and 1 ppm of each impurity: A, C and melamine and 5 ppm of impurity B in mobile phase

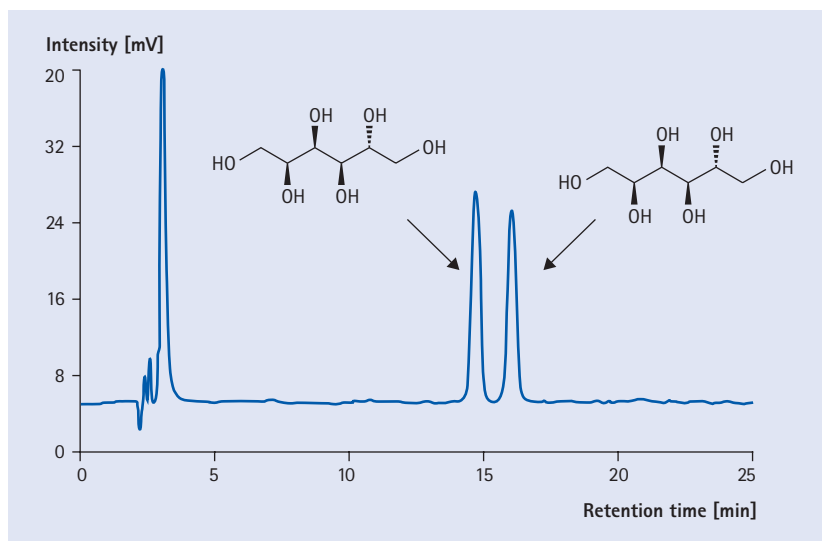

SeQuant[®] ZIC[®]-pHILIC

Polymeric columns with extended pH stability for demanding separations of hydrophilic compounds

Ordering information – SeQuant[®] ZIC[®]-pHILIC analytical PEEK columns

Product	Ordering No.	Particle size	Beads	Dimension length	Dimension i.d.	Contents of one package
ZIC [®] -pHILIC PEEK HPLC column	1.50459.0001	5 µm	polymeric	50 mm	2.1 mm	1 piece
ZIC [®] -pHILIC PEEK HPLC column	1.50462.0001	5 µm	polymeric	100 mm	2.1 mm	1 piece
ZIC [®] -pHILIC PEEK HPLC column	1.50460.0001	5 µm	polymeric	150 mm	2.1 mm	1 piece
ZIC [®] -pHILIC PEEK HPLC column	1.50463.0001	5 µm	polymeric	50 mm	4.6 mm	1 piece
ZIC [®] -pHILIC PEEK HPLC column	1.50464.0001	5 µm	polymeric	100 mm	4.6 mm	1 piece
ZIC [®] -pHILIC PEEK HPLC column	1.50461.0001	5 µm	polymeric	150 mm	4.6 mm	1 piece
ZIC [®] -pHILIC Guard column (1-pak)	1.50437.0001	5 µm	polymeric	20 mm	2.1 mm	1 piece
ZIC [®] -pHILIC Guard column incl. column coupler (3-pak)	1.50438.0001	5 µm	polymeric	20 mm	2.1 mm	3 pieces

For more information please visit www.merckmillipore.com/zicphilic

Separation example on ZIC[®]-pHILIC

LC-MS of dithiocarbamates

Column	ZIC [®] -pHILIC 150 x 4.6 mm, 5 µm, 100 Å [Ord. No. 1.50461.0001]		
Mobile phase	A: acetonitrile B: 10 mM ammonia		
Gradient	Time [min]	% A	% B
	0.0-5.0	90	10
	5.0-13.0	60	40
	13.0-16.0	40	60
Flow rate	0.7 mL/min		
Detection	Electrospray-MS in negative mode. Single ion monitoring (SIM) at m/z 120, 126, 211, 215 and 191		
Temperature	ambient		
Injection volume	5 µL		
Diluent	10 mM each of NaHCO ₃ and DL-Penicillamine pH 12 with NaOH		
Sample	DMD, d6-DMD, EBD, d4-EBD and PBD (20 mg/L for UV and 0.4 mg/L for MS)		
	Void volume (t ₀)	2.0 min	–
	1. DMD (Ziram)	2.2 min	0.1
	2. PBD (Propineb)	12.4 min	5.2
	3. EBD (Zineb)	12.8 min	5.4

Courtesy of John/Wiley & Sons LTD. Original article *Rapid Commun. Mass Spectrom*, 21 (2007) 4009-4016

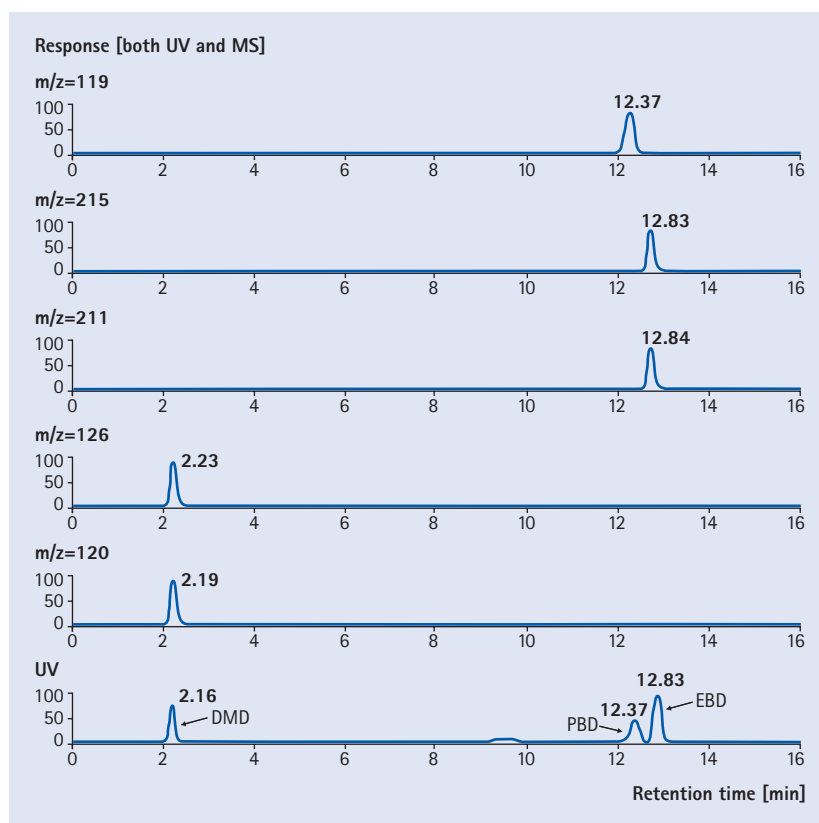

Chiral stationary phases

Always the proper column for enantiomer analysis

Chiral stationary phases

Chirality has become vitally important in the pharmaceutical, chemical, and agricultural industries. The differences which make compounds chiral can produce critically different pharmacological effects in biological systems. As a result, demand for stereoselective separation techniques and analytical assays to evaluate the enantiomeric purity of chiral compounds has increased. Chiral chromatography has become a necessary tool – not only for the analytical determination of enantiomeric purity, but also for the isolation of pure enantiomers. The chromatographic enantiomer separation by chiral stationary phase is an efficient and rapid method in the control of chiral pharmaceuticals or flavour ingredients.



Characterization of chiral HPLC columns

The separation of enantiomers by chiral HPLC has proven to be a most useful method for the analysis of numerous different chiral substances. Of greatest importance is the separation of chiral drugs. Many drugs are administered as racemates. For some chiral drugs, the desired pharmacological effect is almost entirely due to one enantiomer while its other optical isomer may be responsible for significant undesirable side effects. The administration of only optical highly purified drugs is the major goal of pharmaceutical industry, to protect the patient against side-effects, caused by too high drug concentration or against toxic side effects. Chiral HPLC is a very efficient method for the separation of racemic drugs, to control the optical purity and is also a method for the preparation of optical pure drugs. Chiral HPLC is also a valuable tool for the enantioseparation of agrochemicals or flavour compounds.

Enantiomers may confer benefits over racemates for therapeutic uses

Properties of racemate	Potential benefits of enantiomers
One enantiomer is exclusively active	Reduced dose and load on metabolism
The other enantiomer is toxic	Increased latitude in dose and broader use of the drug
Enantiomers have different pharmacokinetics	Better control of kinetics and dose
Enantiomers metabolize at different rates in the same person	Wider latitude in setting the dose Reduction in variability of patient's responses
Enantiomers metabolize at different rates in the population	Reduction in variability of patient's responses Greater confidence in setting a single dose
One enantiomer prone to interaction with key detoxification pathways	Reduced interactions with other common drugs
One enantiomer is agonist, the other antagonist	Enhanced activity and reduction of dose
Enantiomers vary in spectra of pharmacological action and tissue specificity	Increased specificity and reduced side effects for one enantiomer, use of other enantiomer for different indication

► [Column selection guide](#)
page 188

► [ChiraDex®](#)
Specially for the separation of enantiomers
page 364

Accessories for particulate HPLC columns:

► [manu-CART® cartridge holder for LiChroCART® cartridges](#)
page 370

► [LiChroCART® cartridge](#)
Different lengths, different internal diameter
page 373

► [Hibar® column](#)
page 375

ChiraDex®

Specially for the separation of enantiomers

ChiraDex® is a versatile HPLC column characterized by broad enantioselectivity and can be used for the separation of enantiomers of numerous different classes of substances. ChiraDex® is based on beta-cyclodextrin covalently linked to spherical particles of silica and is well suited for the chiral separation of hydrocarbons, steroids, phenol esters and derivatives, aromatic amines, heterocycles with 5-membered ring to 7-membered ring. Simply composed RP-eluents can be used in most separations.

Characterization of ChiraDex®

ChiraDex® is characterized by broad enantioselectivity and can be used for the separation of enantiomers of numerous different classes of substances. Cyclodextrins are cyclic oligosaccharins consisting of α -1,4-glycosidically linked D-glucose units. β -cyclodextrin consist of 7 glucose units, respectively. Geometrically seen, cyclodextrins may be described as truncated cones, where all the secondary hydroxy groups are directed towards the larger opening, whereas the smaller opening at the other end is formed by primary hydroxy groups.

Thus, a hydrophobic inner cavity results, contrasting with the two hydrophilic openings. Since cyclodextrins are made up of chiral D-glucose units, its structure may be regarded as a chiral selector. The enantiomers of a racemic substance mixture, due to their opposite configurations, can now be associated – to different degrees – with the cyclodextrin molecule. Thus, diastereomeric "inclusion complexes" are formed, based on hydrophobic interaction (between cavity and guest molecule) and stereo selective hydrogen bonds (between the C2 and C3 hydrogen groups of glucose molecules and the guest molecule).

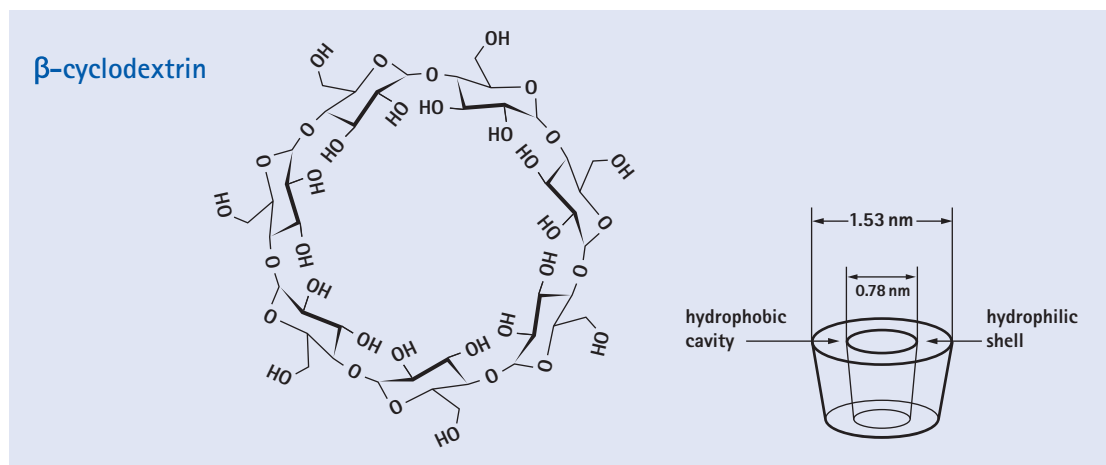

Specifications of ChiraDex®

Sorbent characteristics	Spherical silica particles with covalently bonded beta-cyclodextrin particles
Particle shape	spherical
Particle size	5 μ m
Efficiency	>25 000 N/m
HighResolution	>37 000 N/m
Pore size	10 nm (100 Å)
Spec. surface area	300 – 360 m ² /g
Chiral selector	Beta-cyclodextrin
pH range	pH 3 – 7.5
Shipping eluent	Methanol/Water

Accessories for particulate HPLC columns:

- ▶ manu-CART® cartridge holder for LiChroCART® cartridges

page 370

- ▶ LiChroCART® cartridge Different lengths, different internal diameter

page 373

Ordering information – ChiraDex®, stainless steel columns Hibar®

Product	Ordering No.	Particle size	Dimension length	Dimension i.d.	Contents of one package
ChiraDex®	1.50013.7004	5 µm	100 mm	4.6 mm	1 piece

The Hibar® columns are complete with endfittings. When using a guard column with a Hibar® column, we recommend part number 1.51487.0001 guard column cartridge holder for 4–4 mm guard column cartridges LiChroCART®. Additional dimensions available as customized packings see page 366.

Ordering information – ChiraDex®, stainless steel cartridges LiChroCART®

Product	Ordering No.	Particle size	Dimension length	Dimension i.d.	Contents of one package
ChiraDex®	1.50117.0001	5 µm	4 mm	4 mm	10 pieces
ChiraDex®	1.51333.0001	5 µm	250 mm	4 mm	1 piece
ChiraDex® HighResolution	1.51000.0001	5 µm	250 mm	4 mm	1 piece

The LiChroCART® columns in the list above require part number 1.51486.0001 manu-CART® cartridge column holder, which can be used to hold one cartridge column with or without a 4–4 mm guard column.

Separation examples of chiral pharmaceutical active ingredients on ChiraDex®

Cromakalim

Column	LiChroCART® 250-4 ChiraDex®
Mobile phase	Water/Methanol 80/20 (v/v)
Flow rate	0.8 mL/min
Detection	UV 254 nm

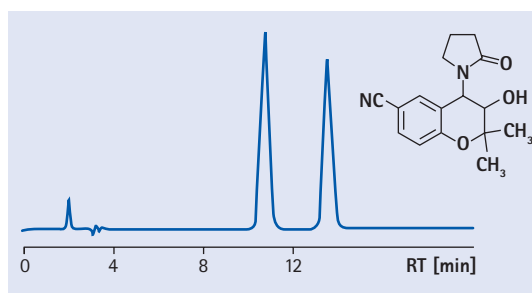

Selectivity with Sertralin

Column	LiChroCART® 250-4 ChiraDex® HighResolution
Mobile phase	Acetonitril/10 mM Phosphat buffer adjusted with Triethylamin to pH=7.0 30/70 v/v
Flow rate	0.6 mL/min
Detection	UV 220 nm
Injection volume	5 µL
Sample	1 mg/mL Sertralin

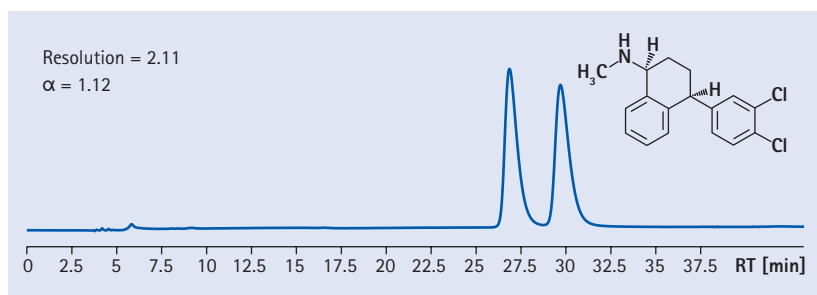

Customized packings

On top of the very extensive column assortment Merck Millipore offers customized packed columns for highest flexibility and professional solutions. Finding the right column for every separation is a tedious business. Merck Millipore, as manufacturer and supplier, can solve this problem for you – from one source. The sorbents and the packed HPLC columns are tested before delivering. The sorbents manufactured by Merck Millipore are subjected to the most stringent controls; some 42 different parameters are tested for each sorbent. Each finished column is provided with an Analysis Certificate.

▶ **Purospher® STAR RP-18 endcapped**
The versatility you need!
page 269

▶ **Purospher® STAR RP-8 endcapped** Ideal for less hydrophobic compounds
page 283

▶ **Purospher® STAR Phenyl**
Enhanced selectivity for aromatic compounds
page 286

▶ **Purospher® RP-18 endcapped** Excellent peak symmetry with either basic or strongly acidic compounds
page 302

▶ **Purospher® RP-18**
Polar endcapped column material
page 304

▶ **Superspher®**
Silica carrier for highly efficient separations
page 308

▶ **LiChrosorb®**
A successful packing material from the start
page 343

▶ **LiChrospher® Si 60 and Si 100**
page 340

Accessories for particulate HPLC columns:

▶ **manu-CART® cartridge holder** for LiChroCART® cartridges
page 370

▶ **LiChroCART® cartridge**
Different lengths, different internal diameter
page 373

▶ **Hibar® column**
page 375



Customized packings

Always the right column

Easy ordering: Please combine the ordering number of the column hardware [LiChroCART® or Hibar® RT] and the sorbent number.

Example: Customized packing ordering number of LiChroCART® 125-4 **1.50170.**
 Sorbent number of Purospher® RP-18 HC, 5 µm **7131**
 Ordering number of Purospher® RP-18 HC, 5 µm, LiChroCART® 125-4 **1.50170.7131**

Ordering information – Customized packings, stainless steel cartridges LiChroCART®

Product	Ordering No.	Dimension length	Dimension i.d.	Packing material
LiChroCART® 10-2	1.50201.*	10 mm	2 mm	*as specified (sorbent numbers)
LiChroCART® 30-2	1.50229.*	30 mm	2 mm	*as specified (sorbent numbers)
LiChroCART® 55-2	1.50234.*	55 mm	2 mm	*as specified (sorbent numbers)
LiChroCART® 100-2	1.51939.*	100 mm	2 mm	*as specified (sorbent numbers)
LiChroCART® 125-2	1.50195.*	125 mm	2 mm	*as specified (sorbent numbers)
LiChroCART® 150-2	1.51940.*	150 mm	2 mm	*as specified (sorbent numbers)
LiChroCART® 250-2	1.50190.*	250 mm	2 mm	*as specified (sorbent numbers)
LiChroCART® 30-3	1.50233.*	30 mm	3 mm	*as specified (sorbent numbers)
LiChroCART® 55-3	1.50236.*	55 mm	3 mm	*as specified (sorbent numbers)
LiChroCART® 100-3	1.51941.*	100 mm	3 mm	*as specified (sorbent numbers)
LiChroCART® 125-3	1.50175.*	125 mm	3 mm	*as specified (sorbent numbers)
LiChroCART® 150-3	1.51942.*	150 mm	3 mm	*as specified (sorbent numbers)
LiChroCART® 250-3	1.50177.*	250 mm	3 mm	*as specified (sorbent numbers)
LiChroCART® 300-3.9	1.51943.*	300 mm	3.9 mm	*as specified (sorbent numbers)
LiChroCART® 4-4	1.50173.*	4 mm	4 mm	*as specified (sorbent numbers)
LiChroCART® 25-4	1.50172.*	25 mm	4 mm	*as specified (sorbent numbers)
LiChroCART® 30-4	1.50302.*	30 mm	4 mm	*as specified (sorbent numbers)
LiChroCART® 55-4	1.50228.*	55 mm	4 mm	*as specified (sorbent numbers)
LiChroCART® 75-4	1.50171.*	75 mm	4 mm	*as specified (sorbent numbers)
LiChroCART® 125-4	1.50170.*	125 mm	4 mm	*as specified (sorbent numbers)
LiChroCART® 250-4	1.50174.*	250 mm	4 mm	*as specified (sorbent numbers)
LiChroCART® 100-4.6	1.51448.*	100 mm	4.6 mm	*as specified (sorbent numbers)
LiChroCART® 125-4.6	1.51442.*	125 mm	4.6 mm	*as specified (sorbent numbers)
LiChroCART® 150-4.6	1.51432.*	150 mm	4.6 mm	*as specified (sorbent numbers)
LiChroCART® 250-4.6	1.51431.*	250 mm	4.6 mm	*as specified (sorbent numbers)
LiChroCART® 10-10	1.50178.*	10 mm	10 mm	*as specified (sorbent numbers)
LiChroCART® 75-10	1.51449.*	75 mm	10 mm	*as specified (sorbent numbers)
LiChroCART® 100-10	1.51445.*	100 mm	10 mm	*as specified (sorbent numbers)
LiChroCART® 125-10	1.51443.*	125 mm	10 mm	*as specified (sorbent numbers)
LiChroCART® 150-10	1.51444.*	150 mm	10 mm	*as specified (sorbent numbers)
LiChroCART® 250-10	1.50179.*	250 mm	10 mm	*as specified (sorbent numbers)

The LiChroCART® columns (75, 125, 150 and 250 mm length) in the list above (2, 3, 4 and 4.6 mm i.d.) require part number 1.51486.0001 manu-CART® cartridge column holder, which can be used to hold one cartridge column with or without a 4-4 mm guard column. LiChroCART® columns 250-10 mm require part number 1.51419.0001 manu-CART® 10. The short LiChroCART® columns (30 and 55 mm length) can be ordered as a set including the corresponding cartridge holder and one cartridge, or as a pack of 3 cartridges without cartridge holder. The separate part numbers for the cartridge are as follows: 1.50227.0001 LiChroCART® cartridge holder for 30 mm cartridge and 1.50226.0001 LiChroCART® cartridge holder for 55 mm cartridge.



LiChroCART® cartridges 2, 3, 4 and 4.6 mm i.d. and 75, 125 and 250 mm length



manu-CART® NT cartridge holder for LiChroCART® cartridges 2, 3, 4 and 4.6 mm i.d. and 75, 100, 125, 150 and 250 mm length

Customized packings

Hibar® column 2, 3, 4 and 4.6 mm i.d. and customized packing 4.6 mm i.d.



Ordering information – Customized packings, stainless steel columns Hibar® RT

Product	Ordering No.	Dimension length	Dimension i.d.	Packing material
Hibar® RT 50-2	1.51928.*	50 mm	2 mm	*as specified (sorbent numbers)
Hibar® RT 100-2	1.51929.*	100 mm	2 mm	*as specified (sorbent numbers)
Hibar® RT 125-2	1.51930.*	125 mm	2 mm	*as specified (sorbent numbers)
Hibar® RT 150-2	1.51931.*	150 mm	2 mm	*as specified (sorbent numbers)
Hibar® RT 250-2	1.51932.*	250 mm	2 mm	*as specified (sorbent numbers)
Hibar® RT 50-3	1.51923.*	50 mm	3 mm	*as specified (sorbent numbers)
Hibar® RT 100-3	1.51924.*	100 mm	3 mm	*as specified (sorbent numbers)
Hibar® RT 125-3	1.51925.*	125 mm	3 mm	*as specified (sorbent numbers)
Hibar® RT 150-3	1.51926.*	150 mm	3 mm	*as specified (sorbent numbers)
Hibar® 250-3	1.00423.*	250 mm	3 mm	*as specified (sorbent numbers)
Hibar® RT 300-3.9	1.51933.*	300 mm	3.9 mm	*as specified (sorbent numbers)
Hibar® 30-4	1.51196.*	30 mm	4 mm	*as specified (sorbent numbers)
Hibar® RT 50-4	1.51927.*	50 mm	4 mm	*as specified (sorbent numbers)
Hibar® 125-4	1.50181.*	125 mm	4 mm	*as specified (sorbent numbers)
Hibar® 250-4	1.50182.*	250 mm	4 mm	*as specified (sorbent numbers)
Hibar® 100-4.6	1.50013.*	100 mm	4.6 mm	*as specified (sorbent numbers)
Hibar® 125-4.6	1.50012.*	125 mm	4.6 mm	*as specified (sorbent numbers)
Hibar® 150-4.6	1.50009.*	150 mm	4.6 mm	*as specified (sorbent numbers)
Hibar® 250-4.6	1.00424.*	250 mm	4.6 mm	*as specified (sorbent numbers)
Hibar® 250-10	1.50183.*	250 mm	10 mm	*as specified (sorbent numbers)

The Hibar® columns are complete with endfittings. When using a guard column with a Hibar® column, we recommend part number 1.51487.0001 guard column cartridge holder for 4–4 mm guard column cartridges LiChroCART®.



Ordering information – Customized packing, stainless steel UHPLC columns Hibar® HR

Product	Ordering No.	Dimension length	Dimension i.d.	Packing material
Hibar® HR 30-2.1	1.51934.*	30 mm	2.1 mm	*as specified (sorbent numbers)
Hibar® HR 50-2.1	1.51935.*	50 mm	2.1 mm	*as specified (sorbent numbers)
Hibar® HR 100-2.1	1.51936.*	100 mm	2.1 mm	*as specified (sorbent numbers)
Hibar® HR 150-2.1	1.51937.*	150 mm	2.1 mm	*as specified (sorbent numbers)
Hibar® HR 250-2.1	1.51938.*	250 mm	2.1 mm	*as specified (sorbent numbers)

Ordering information – Sorbents

Product	Sorbent No.
Purospher® STAR	
Purospher® STAR RP-18 endcapped, 2 µm (for UHPLC columns only)	*.7236
Purospher® STAR RP-18 endcapped, 3 µm	*.7184
Purospher® STAR RP-18 endcapped, 5 µm	*.7185
Purospher® STAR RP-8 endcapped, 2 µm (for UHPLC columns only)	*.7237
Purospher® STAR RP-8 endcapped, 3 µm	*.7220
Purospher® STAR RP-8 endcapped, 5 µm	*.7194
Purospher® STAR Phenyl, 2 µm (for UHPLC columns only)	*.7232
Purospher® STAR Phenyl, 3 µm	*.7234
Purospher® STAR Phenyl, 5 µm	*.7235
Purospher® STAR NH ₂ , 5 µm	*.7177
Purospher® STAR Si, 3 µm	*.7174
Purospher® STAR Si, 5 µm	*.7175
Purospher® RP-18 endcapped	
Purospher® RP-18 endcapped, 5 µm	*.7130
Purospher® RP-18 endcapped, 10 µm	*.7207
Purospher® RP-18	
Purospher® RP-18, 5 µm	*.7127
Purospher® Si, 5 µm	*.7180
Purospher® RP-18 HC	
Purospher® RP-18 HC	*.7131
Superspher®	
Superspher® 60 Si, 4 µm	*.7142
Superspher® 100 Si, 4 µm	*.7143
Superspher® 60 RP-8, 4 µm	*.7139
Superspher® 60 RP-8 endcapped, 4 µm	*.7140
Superspher® 60 RP-select B, 4 µm	*.7141
Superspher® 100 RP-18, 4 µm	*.7137
Superspher® 100 RP-18 endcapped, 4 µm	*.7138
LiChrosorb®	
LiChrosorb® RP-8, 5 µm	*.7057
LiChrosorb® RP-8, 10 µm	*.7059
LiChrosorb® RP-18, 5 µm	*.7052
LiChrosorb® RP-18, 10 µm	*.7054

Product	Sorbent No.
Aluspher®	
Aluspher® 100 RP-select B, 5 µm	*.7002
LiChrospher®	
LiChrospher® Si 60, 5 µm	*.7109
LiChrospher® Si 60, 10 µm	*.7104
LiChrospher® Si 60, 12 µm	*.7106
LiChrospher® Si 60, 15 µm	*.7098
LiChrospher® Si 100, 5 µm	*.7110
LiChrospher® Si 100, 10 µm	*.7101
LiChrospher® Si 100, 15 µm	*.7100
LiChrospher® 100 CN, 5 µm	*.7071
LiChrospher® 100 CN, 10 µm	*.7070
LiChrospher® 100 DIOL, 5 µm	*.7075
LiChrospher® 100 NH ₂ , 5 µm	*.7076
LiChrospher® 100 NH ₂ , 10µm	*.7077
LiChrospher® 100 RP-8, 5 µm	*.7087
LiChrospher® 100 RP-8, 10 µm	*.7088
LiChrospher® 100 RP-8 endcapped, 5 µm	*.7092
LiChrospher® 100 RP-8 endcapped, 10 µm	*.7091
LiChrospher® 60 RP-select B, 5 µm	*.7093
LiChrospher® 60 RP-select B, 10 µm	*.7094
LiChrospher® 60 RP-select B, 15 µm	*.7209
LiChrospher® 60 RP-select B, 25 µm	*.7095
LiChrospher® 100 RP-18, 5 µm	*.7079
LiChrospher® 100 RP-18, 10 µm	*.7081
LiChrospher® 100 RP-18, 12 µm	*.7208
LiChrospher® 100 RP-18, 15 µm	*.7206
LiChrospher® 100 RP-18 endcapped, 5 µm	*.7085
LiChrospher® 100 RP-18 endcapped, 10 µm	*.7084
LiChrospher® 100 PAH, 5 µm	*.7078
LiChrospher® 300 WP RP-18, 5 µm	*.7116
LiChrospher® 300 WP RP-18, 12 µm	*.7114
LiChrospher® 300 WP RP-18, 15 µm	*.7115
Chiral HPLC sorbents	
ChiraDex®, 5 µm	*.7004

manu-CART® cartridge holder for LiChroCART® cartridges

Accessories for particulate HPLC columns

The "one-turn" cartridge system for simple, rapid "hands only" fitting of cartridges and precolumns. manu-CART® cartridge holder for the LiChroCART® cartridge system are ingenious. They are reusable and fit every cartridge length with different internal diameter. And a simple turn permits an easy and problem-free integration of a guard cartridge. For coupling of two LiChroCART® cartridges a coupling unit can be used and for connecting a LiChroCART® HPLC cartridge with a LiChroCART® 25-4 pre-cartridge the coupling kit. The manu-CART® cartridge holder fits for 2, 3, 4 and 4.6 mm i.d. LiChroCART® cartridges and 75, 100, 125, 150 and 250 mm length



LiChroCART® HPLC cartridge (i.d. 2, 3, 4 and 4.6 mm) and LiChroCART® 4-4 (or 10-2) HPLC guard cartridge with manu-CART® NT 1.51486

Selection of manu-CART® cartridge holder

Cartridge holder	Ordering No.	LiChroCART® cartridge
manu-CART® 25 mm	1.50017.0001	25-4 and 25-2
manu-CART® 30 mm	1.50227.0001	30-2, 30-3 and 30-4
manu-CART® 55 mm	1.50226.0001	55-2, 55-3 and 55-4
manu-CART® NT	1.51486.0001	75-4
manu-CART® NT	1.51486.0001	100-4.6
manu-CART® NT	1.51486.0001	125-2, 125-3, 125-4 and 125-4.6
manu-CART® NT	1.51486.0001	150-4.6
manu-CART® NT	1.51486.0001	250-2, 250-3, 250-4 and 250-4.6
manu-CART® 10-II	1.51419.0001	75-10, 100-10, 125-10, 150-10 and 250-10

manu-CART® cartridge holder for LiChroCART® cartridges

Ordering information – manu-CART® cartridge holder, manu-CART® endfittings for stainless steel cartridges LiChroCART®

Product	Ordering No.	Contents of one package
manu-CART® NT cartridge holder for 2, 3, 4 and 4.6 mm i.d. LiChroCART® cartridges	1.51486.0001	2 complete stainless steel units for mounting one LiChroCART® cartridge
manu-CART® "10" II cartridge holder for 10 mm i.d. LiChroCART® cartridges	1.51419.0001	2 complete stainless steel units for mounting one LiChroCART® cartridge
manu-CART® coupling kit for coupling with LiChroCART® 25-4 pre-cartridge	1.50082.0001	1 coupling unit 1 endfitting for LiChroCART® 25-4
manu-CART® coupling unit to connect two LiChroCART® cartridges	1.50083.0001	1 piece
manu-CART® holder 25-4 and 25-2	1.50017.0001	1 piece
manu-CART® holder 30 mm for 30-2, 30-3 and 30-4 LiChroCART® cartridges	1.50227.0001	1 piece
manu-CART® holder 55 mm for 55-2, 55-3 and 55-4 LiChroCART® cartridges	1.50226.0001	1 piece
Pressure cone for manu-CART® endfitting	1.51258.0001	2 pieces
Split collets for manu-CART® endfitting	1.51257.0001	4 pieces



*manu-CART® holder 30 mm [1.50227]
for LiChroCART® 30-4, 30-3 and 30-2*



*manu-CART® holder 55 mm [1.50226]
for LiChroCART® 55-4, 55-3 and 55-2*

Mounting of patented manu-CART® endfittings nothing could be simpler

Mounting with guard cartridge 4-4 or 10-10

1. Slide sleeve over cartridge.
2. Fix split-collets in the groove in direction of the guard cartridge. Apply guard cartridge with its cone in direction of the main cartridge, slide sleeve on top and fasten with cap nut.



Mounting without guard cartridge

1. Slide sleeve with external thread over cartridge.
2. Using your finger, hold one split-collet at the groove. Apply the second split-collet, slide sleeve over it and fasten with cap nut.



What can also be connected to manu-CART®?

manu-CART® NT cartridge holder [1.51486.0001] for LiChroCART® cartridge of 75, 100, 125, 150 and 250 mm length and 2, 3, 4 and 4.6 mm i.d.

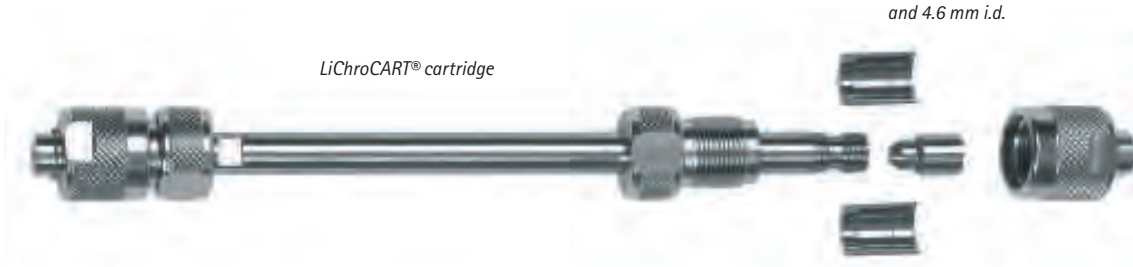

Use of LiChroCART® 4-4 or 10-2 guard cartridges with manu-CART® NT



Coupling two LiChroCART® HPLC cartridges (of 75, 100, 125, 150 and 250 mm length) with coupling unit [1.50083]



Connecting a LiChroCART® HPLC cartridge with a LiChroCART® 25-4 and 25-2 pre-cartridge with coupling kit [1.50082]



Mounting a LiChroCART® 25-4 and 25-2 pre-cartridge with endfitting [from 1.50082] and cap nut [from 1.51486]

LiChroCART® cartridge

Accessories for particulate HPLC columns

The LiChroCART® cartridge – different lengths, different internal diameter

With LiChroCART® cartridges the user works with re-usable endfittings which fit different cartridge lengths. Since these cartridge holders may remain in the system and the capillary connections do not need to be detached, the cartridges may be changed within the shortest possible time. Changing a separation cartridge from a length of 125 to 250 mm and back presents no problems. Furthermore, the adaptation of internal diameter (3 mm or 2 mm) to the analysis problem is possible within a few minutes. The endfittings are designed to allow the cartridges to be hand-sealed at normal working pressures of 150 to 200 bar without the need for any tools. Only at higher pressures may further tightening with a wrench become necessary.



*manu-CART® NT cartridge holder
for LiChroCART® cartridges
2, 3, 4 and 4.6 mm i.d. and 75, 100,
125, 150 and 250 mm length*

*LiChroCART® cartridges
2, 3, 4 and 4.6 mm i.d. and 75,
125 and 250 mm length*



Ordering information – Accessories for stainless steel cartridges LiChroCART®

Product	Ordering No.	Contents of one package
LiChroCART® frit elements for 4 mm and 4.6 mm i.d. cartridges	1.51496.0001	10 stainless steel frits with PFA ring seals 10 glass fibre filters*
LiChroCART® Assembly tool for replacement of frits 2, 3, 4 and 4.6 mm i.d	1.15576.0001	1 centering sleeve 1 assembly tool 1 tool for replacement of sealing rings from LiChroCART® cartridges

Pore size of filters: 2 µm | * Assembly tool 1.15576.0001 not included



*Tool for replacement
of sealing rings
and ring seals with frits*

Cartridges save costs

The HPLC cartridge is a sorbent-filled stainless steel tube closed at both ends by a filter element and fitted with a groove for the holding device. No threads are necessary. The connection pieces can be used over and over again. The cartridge is therefore more economical and in the long run the right concept for reducing analysis costs. Cartridge kits containing the cartridge, the holding devices and a precolumn, allow for a favorably priced start in the HPLC technique. This technology becomes uniquely advantageous by the use of statistically tested cartridges for the most frequently used RP-chromatography applications. Optimum control of the packing process is decisive in this case. Batch size, automation and packing technology for today's RP-materials have reached a standard permitting random testing. The reversed-phase cartridges offered in favorably priced 3-packs are the work horses of chromatography.

A package LiChroCART®
4 x 4 mm precolumns



Cartridges with precolumns have longer lives

The flexibility of the cartridge system becomes obvious in the integration of precolumns. Without the need for additional precolumn holders and capillaries, 4 x 4 mm precolumns may be integrated into the system practically void volume-free. A simple turn of the split collets holding the cartridges in the fitting suffices. A precolumn change also presents no problems. In this way, the lifetime of the separation cartridge may be extended simply and cost-effectively.

Exchanging the sieve and glass fiber filter of LiChroCART® cartridges [using assembly tool]

1. Remove the manu-CART® "4" endfitting. Put them aside for re-use later. Screw the mini cork-screw tool into the PTFE ring and pull gently to remove the filter (A).
2. In case of a PFA filter take the stainless steel core in addition to guide the screw tool.
3. Using a small spatula remove the remains of the glass fiber filter and any soiled packing material. Fill the void with freshly prepared packing material and smooth off the surface. Place a new filter on the top of the cartridge. Use the broad end of the plastic tool to push the filter into the cartridge (B).
4. Place a PTFE sealing element into the open end of the cartridge and press it firmly into its place by using the narrow end of the plastic tool and the plastic core for guiding (C).
5. In case of a PFA element take the new plastic tool to have more power.
6. Reassemble the manu-CART® endfitting and re-equilibrate the column.

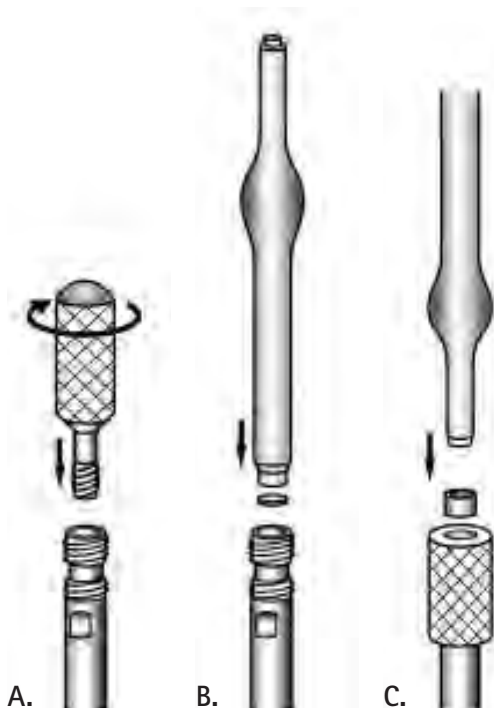

Hibar® column

Accessories for particulate HPLC columns

The traditional heart of HPLC is the "ready-to-use" column with threads at both ends onto which reducers for capillary connection are screwed. As a rule, precolumns are coupled with the main column via capillaries. If the column is exhausted, the user has two possibilities: Refilling, provided aggressive eluents do not prevent this by causing corrosion or worn threads, or the whole column is discarded. Column refilling without tube revision is problematic in view of GLP since each column has a different "history" and a different pretreatment for each new assignment.



*Hibar® column
Purospher® STAR 2, 3, 4 and 4.6 mm i.d.
and customized packing 4.6 mm i.d.*

Ordering information – Guard column holder for Hibar® columns

Product	Ordering No.	Contents of one package [see figure on next 2 pages]
Precolumn holder for 4-4 LiChroCART® cartridges for capillary connection to Hibar® column	1.16217.0001	1 piece
Precolumn holder for 4-4 LiChroCART® cartridges for direct coupling to Hibar® column	1.51487.0001	1 piece

Mounting of LiChroCART® 4 x 4 mm precolumn to any analytical HPLC column



Mounting of LiChroCART® 4 x 4 mm precolumn to Hibar® RT analytical HPLC column for direct connection with column holder [1.51487.0001]



Ordering information – Hibar® / LiChroCART® capillaries

Product	Ordering No.	Dimension i.d.	Contents of one package
Stainless steel capillaries (o.d. 0.5 mm, i.d. 0.20 mm)	1.51236.0001	1000 mm	3 pieces



Ordering information – Hibar® / LiChroCART® nuts and ferrules

Product	Ordering No.	Contents of one package
Dead-volume free coupling unit for capillary connection (o.d. 1/16" or 0.5 mm)	1.51252.0001	3 units
Knurled nuts for capillary connection with PVDF double cones	1.15545.0001	4 knurled nuts
Knurled nuts with long bushing for Rheodyne	1.51237.0001	2 knurled nuts 6 PVDF double cones
PVDF double cones for capillary tubing (1/16") with knurled screw [Fit with Ord. No. 1.15545 or 1.51216]	1.51238.0001	10 PVDF double cones
PVDF double cones for capillary connection (o.d. 0.5 mm) with knurled nuts [Fit with Ord. No. 1.15545]	1.15546.0001	10 PVDF double cones

1.15545.0001

1.51252.0001

1.51238.0001

1.51237.0001

1.15546.0001



LiChroTest®

Standard samples for HPLC system qualification

The quality of analytical results is principally determined by the correct functioning of the analytical instruments employed. For this reason, the various quality assurance systems as well as the FDA require analytical instruments to be subjected to periodical qualification. Therefore, before starting a series of analyses, you first should establish whether your HPLC system meets with your requirements. These "Operational Qualification" (OQ) and "Performance Qualification" (PQ) steps involve tests of the different modules on their specifications and a check on the entire system using a real application relevant to the laboratory-specific requirements. In order to facilitate this instrument qualification in the HPLC laboratory, Merck Millipore and VWR International have developed the LiChroTest® products. These enable time saving operational and performance qualification to be performed routinely and according to standardized methods.

Characterization of LiChroTest®

For both, Operational Qualification and Performance Qualification, different test samples for checking precision, accuracy, linearity and sample-carry-over of the different HPLC modules or the complete system are available. Each set contains several ampoules of sample accompanied by a Certificate of Analysis that ensures uniform quality and traceability to international standards. These test samples can be used to perform a simple and standardized check of the critical parameters of HPLC system function.

LiChroTest® PQ – Performance Qualification

For Performance Qualification, the LiChroTest® PQ, a complete test kit for 8 different system tests, is ideal. The test procedure involved has been selected and optimized to include meaningful system performance parameters and to ensure ease-of-use, time saving and extensive automation. The kit comprises an HPLC column, test samples, a description of the qualification process and the test methods as well as an example test report which are suitable for use with any HPLC system. In this way, you can rapidly and routinely carry out fully automatic performance qualification of your HPLC instruments. The documentation completed in the course of the qualification procedure is very useful for passing future audits.

The following HPLC system tests can be carried out:

- Qualification of system communication
- Qualification of data processing
- Baseline noise and drift levels
- System suitability test: Peak width and symmetry
- Repeatability: Peak area and retention time
- Linearity
- Sample carry-over
- Qualification of system control

The LiChroTest® PQ kit contains ready to use methods for the LaChrom® D-7000 HPLC System Manager software and for the EZChrom Elite chromatography data system in combination with LaChrom® and LaChrom® Elite systems. The certified standard samples contained in the LiChroTest® PQ kit are available as refill packs. Six further UV/VIS standard solutions from Merck Millipore are also available for checking photometers, spectrophotometers and UV detectors for wavelength accuracy, stray light, spectral resolution and absorption accuracy according to the European Pharmacopoeia (Ph Eur). LiChroTest® is a further contribution from VWR International and Merck Millipore towards guaranteeing the quality of your analytical results and preparing you for your next audit.

Ordering information – LiChroTest® PQ: LiChroTest® Standard samples for HPLC System Performance Qualification

Product	Ordering No.	Contents of one package
LiChroTest® PQ Set 1A: Precision and Linearity (PQ)	1.19157.0001	Refill pack for the LiChroTest® PQ Kit. 1.19156.0001 Dilution series of methyl paraben in methanol/water (50/50) (concentrations 50, 100, 150, 200 mg/L)
LiChroTest® PQ Set 1: Precision and Linearity (PQ)	1.19165.0001	Refill pack for the old LiChroTest® PQ Kit. 1.15958.0001 Dilution series of methyl paraben in methanol/water (50/50) (concentrations, 1, 10, 100, 200 mg/L)
LiChroTest® PQ Set 3: Precision (PQ)	1.19158.0001	5 Standard samples of 100 mg/L methyl paraben in methanol/ water (50/50) Refill pack for the LiChroTest® PQ set
LiChroTest® PQ Set 3: Separation (Parabens) (PQ)	1.19159.0001	5 Standard samples with 3 different parabens + t_r -marker in methanol/water (50/50), with sample chromatogram and analysis conditions

Ordering information – LiChroTest® OQ: LiChroTest® Standard samples for HPLC System Operational Qualification

Product	Ordering No.	Contents of one package
LiChroTest® OQ Set 5: Autosampler Test (OQ)	1.15201.0001	5 standard samples with perylene in methanol for checking injection precision (OQ) of LaChrom® autosamplers
LiChroTest® OQ Set 7: Precision (OQ)	1.19161.0001	60 mg/L methyl paraben in methanol
LiChroTest® OQ Set 8: Linearity (OQ)	1.19162.0001	Dilution series of methyl paraben in methanol (concentrations: 1.5, 7.5, 15, 75, 150 mg/L)
Caffeine solution A for gradient test (OQ)	1.19163.0001	20 mg/L caffeine in water (0.5 L)
Caffeine solution B for gradient test (OQ)	1.19169.0001	20 mg/L caffeine in methanol (0.5 L)
Caffeine solution for HPLC OQ/PQ	1.19141.0001	Caffeine kit 5 mg/L
Caffeine solution for HPLC OQ/PQ	1.19142.0001	Caffeine kit 50 mg/L
Caffeine solution for HPLC OQ/PQ	1.19143.0001	Caffeine kit 100 mg/L
Caffeine solution for HPLC OQ/PQ	1.19144.0001	Caffeine kit 250 mg/L
Caffeine solution for HPLC OQ/PQ	1.19145.0001	Caffeine kit 500 mg/L

Column care and use

Column hardware

HPLC and UHPLC columns from Merck Millipore come in a variety of different column hardware formats and materials for different applications. All columns have 10-32 UNF female end fittings that connect to 1/16" capillary tubing. Note that removing pre-installed end fittings from HPLC columns might damage the column bed and reduce performance.

Particulate silica columns for reversed phase and normal phase HPLC are delivered in stainless steel column hardware; either as ready-to-use Hibar® columns or as the LiChroCART® cartridge system comprising separately ordered, re-usable end fittings (manu-CART®). Hibar® HR columns have extra-high pressure stability and extremely small internal dead volumes, making them especially suitable for use in UHPLC instruments. Both Hibar® and LiChroCART® columns have stainless steel frits to keep the stationary phase particles in place.

Chromolith® columns are clad with a mechanically stable and chemically robust poly(ether-ether-ketone) polymer (PEEK). The end fittings are made of the same material.

Chromolith® CapROD® columns are of fused silica tubing and contain no frits. These columns are delivered without end fittings.

SeQuant® columns have different column hardware depending on the internal diameter. Analytical sizes (2.1, 4.6, and 7.5 mm i.d.) have PEEK hardware with PEEK frits for maximum inertness towards hydrophilic analytes. SeQuant® semi-preparative columns have stainless steel hardware and stainless steel frits. SeQuant® microbore and capillary columns (1.0 and 0.3 mm i.d.) are of glass-lined stainless steel and contain stainless steel frits. SeQuant® nano columns (100 µm and 75 µm i.d.) are of PEEK-sheeted fused silica tubing.

NB! The fused silica tubing column material of SeQuant® nano columns and Chromolith® CapROD® is brittle and should not be exposed to extensive bending as it might break.

NB! Columns in PEEK, i.e. Chromolith® and SeQuant® analytical columns, cannot be used with more than 50 % tetrahydrofuran (THF), 5 % dichloromethane (DCM) or 5 % dimethylsulfoxide (DMSO). Such solvents can, however, be used at 100 % as sample solvent.

Column hardware	Type	Body	Frit	Max. pressure	Solvent restrictions
Hibar® RT	Ready-to-use	Stainless steel	Stainless steel	400 bar	
Hibar® HR	Ready-to-use	Stainless steel	Stainless steel	600 bar	
LiChroCART®	Cartridge	Stainless steel	Stainless steel	250 bar	
Chromolith®	Ready-to-use	PEEK	-	200 bar	THF, DMSO, DCM
Chromolith® CapROD®	Ready-to-use	Fused silica	-	200 bar	
SeQuant® Analytical	Ready-to-use	PEEK	PEEK	350 bar*	THF, DMSO, DCM
SeQuant® Semi-prep	Ready-to-use	Stainless steel	Stainless steel	400 bar	
SeQuant® Capillary	Ready-to-use	Glass-lined stainless steel	Stainless steel	400 bar	
SeQuant® Nano	Ready-to-use	PEEK-sheeted fused silica	Stainless steel	400 bar	

* The maximum pressure for SeQuant® ZIC®-pHILIC columns is 200 bar due to the polymer-based particles. The maximum pressure for SeQuant® analytical columns decrease with increasing temperature and is 300 bar at 50°C and 200 bar at 70°C, respectively.

Column installation

Merck Millipore HPLC and UHPLC columns are designed to fit any HPLC instrument; however, care should be taken at installation so as not to introduce dead volumes in the connections, which would reduce separation efficiency. Note that stainless steel tubing fittings are inflexible and cannot be adapted to different port designs after the first installation, whereas PEEK fittings can be adjusted for different columns several times. Also note that stainless steel fittings and ferrules can damage the end fittings of PEEK column hardware, especially if installed with excessive force by using wrench tools. Merck Millipore columns should be installed with the flow arrow on the label pointing towards the detector. Before the column outlet is connected to the detector, it is wise to flush the column with mobile phase.

Please have a look on our website for more information about column installation.

Technical support: www.merckmillipore.com/applications-tech-support-film

Mounting of columns: www.merckmillipore.com/mounting-chrom-columns-film

Column equilibration

Proper column equilibration is time well spent as it will give you more consistent results and reduce trouble-shooting. Verify that your mobile phase is miscible with the shipping solvent before starting to flush or equilibrate the column. Gradually increase the flow rate in small steps until it satisfies your conditions. Flush the column with your mobile phase until you obtain a stable baseline. Mobile phases with additives in low concentrations (e.g. ion-pair reagents) may require longer equilibration times.

Reversed phase columns (RP-18, RP-8) are shipped in acetonitrile/water. If the column has dried out during storage or shipping, thoroughly activate the packing by flushing with 10-20 column volumes of pure organic solvent (e.g. acetonitrile) before equilibrating the column with the mobile phase.

Normal phase columns (Si, NH₂, CN, DIOL) are shipped with n-heptane/dioxane (99/1). If they are going to be used with aqueous eluents, flush the column with ethanol or 2-propanol before you equilibrate with the mobile phase.

HILIC columns (ZIC®) are shipped with acetonitrile/water (80/20) containing 5 mM ammonium acetate salt. In the event that the column has dried out, flush with 20 column volumes of water at a low flow rate before equilibrating the column with the mobile phase.

Validating column performance

Every HPLC column from Merck Millipore is delivered with a test certificate displaying its separation efficiency and selectivity at the time of manufacturing. Repeating the test periodically is a good way of following trends in performance change over time. Please note that the test instruments have been optimized so as not to be significantly affected by external sources of band broadening, and that things might be different in your system. For optimum separation efficiency minimize the injection volume, detector volume, capillary tubing length, internal diameter and detector response time. Fast chromatographic peaks from Chromolith®, Purospher® STAR UHPLC and SeQuant® ZIC®-HILIC columns can be just a few seconds wide. Note that for accurate representation of a chromatographic peak the data system needs to enable approximately 20 data points to be acquired during the peak width time.

Mobile phases

Merck Millipore's silica-based particulate HPLC columns in stainless steel hardware are compatible with all organic solvents in pH range mentioned in the table below. However, a few restrictions on the use of THF, DCM and DMSO apply to columns in PEEK hardware (i.e. Chromolith® and SeQuant®), see table above.

For best results, high-quality solvents such as HPLC-grade LiChrosolv® should be used. All prepared buffers should be filtered through a 0.45 µm filter (0.22 µm for UHPLC columns) before use in the HPLC system. Always keep in mind that your column will collect any particulate material that enters the flow stream. The use of non-pure solvents will result in adsorption of impurities on the column head. These impurities block adsorption sites, change the selectivity of the column and lead to peak splitting in the chromatogram. In gradient elution, impure solvents may result in ghost peaks that always appear at the same position in the chromatogram.

Any type of buffer, organic modifier and paired-ion reagent will be compatible with Merck Millipore's HPLC columns as long as the appropriate pH range is not exceeded. Verify that solvents are miscible when changing mobile phases and that no buffer precipitation will occur. Ion-pair reagents are often difficult to flush completely from the column and columns used with these reagents should be dedicated to the particular analysis involved. Ion-pair reagents are also known to reduce sensitivity in mass spectrometry detection.

NB! Ion-pair reagents are not suitable for HILIC columns since they will make the stationary phase less polar and thus diminish retention.

NB! The limited solubility of some buffers (e.g. phosphate) in organic solvents may limit their use in HILIC separations and precautions should thus be taken to avoid precipitation problems.

Column lifetime

Column lifetime is highly dependent on the sample and conditions, and cannot be generalized upon; however, you can apply some general measures to increase the lifetime of the column.

Make sure that your sample and mobile phase are clean and particle-free. Always degas and filter mobile phases. Clean up your sample prior to analysis using filtration or more advanced sample preparations if your sample contains large amounts of contaminants. The use of guard columns is always recommended for real samples.

Pressure stability

Pressure limits for different column formats are listed in the table above. All stationary phases are specified to the same or higher pressures than the hardware except for polymer-based SeQuant® ZIC®-pHILIC, which is pressure-stable up to 200 bar.

pH stability

Silica-based stationary phases have a limited pH stability. A pH higher than the limit will dissolve the silica, creating voids in the column. A lower pH can strip away some of the bonded phase resulting in defects that will cause changes in retention times and loss of resolution. pH stability ranges for stationary phases from Merck Millipore are presented in the table below.

Do not use strong acids (e.g. hydrochloric, nitric, and sulfuric acids) in the column. Limit your use of strong bases (e.g. sodium, potassium, ammonium hydroxide) to amounts needed to adjust the pH of the mobile phase. When measuring the pH of mobile phases, the measurement should be done in the aqueous media before mixing the eluent with organic solvents. Although this will not give the actual pH in the mixed aqueous-organic solvent, it will give more consistent results than a mixed mobile phase.

Stationary phase	pH stability range	Max. temperature
LiChrospher®	2-7.5	60°C
Superspher®	2-7.5	60°C
LiChrosorb®	2-7.5	60°C
Chromolith®	2-7.5	45°C
Purospher®	2-8	65°C
Purospher® STAR RP-18e and RP-8e	1.5-10.5	65°C
SeQuant® ZIC®-HILIC and ZIC®-cHILIC	2-8	70°C
SeQuant® ZIC®-pHILIC	2-12	50°C
Aluspher® RP-select B	2-12	30°C

Temperature stability

The maximum operating temperatures are stated in the table above. To avoid band broadening and loss of separation efficiency the mobile phase should always be kept at the same temperature as the column. This can be done either through the use of active heaters or by passive heating using a short piece of capillary tubing within the column oven.

Storing the column

For short-term storage (overnight), HPLC columns can be stored in the eluent. Always confirm that the column end plugs are firmly in place, regardless of how long the column will be stored. When columns are stored for several days or longer, reversed-phase columns should be stored in an organic solvent, preferably acetonitrile, containing less than 50 % water and no buffer. Purospher® STAR RP-8 endcapped and Purospher® STAR RP-18 endcapped columns are best stored in 100 % acetonitrile. If you are changing storage solvent and your last reversed-phase mobile phase contained buffer salt, flush the column with 10 column volumes of water before storing in organic eluent. Buffer salts might not be soluble in high concentrations of organic solvent and might precipitate and block the column or capillary tubing.

Separation mode	Phases	Short-term storage	Long-term storage
RP [reversed-phase]	<ul style="list-style-type: none"> LiChrosorb® RP-8, RP-18, (DIOL, CN, NH₂)* LiChrospher® RP-8, RP-18, (DIOL, CN, NH₂)* Purospher® STAR RP-8e, RP-18e, Phenyl, (NH₂)* Chromolith® RP-8e, RP-18e, (DIOL, CN, NH₂)* 	Mobile phase	Acetonitrile or acetonitrile in water (<50 %)
NP [normal phase]	<ul style="list-style-type: none"> LiChrosorb® Si, DIOL, CN, NH₂ LiChrospher® Si, DIOL, CN, NH₂ Purospher® STAR Si, NH₂ Chromolith® Si, DIOL, CN, NH₂ 	Mobile phase	n-Heptane or similar organic solvent
HILIC [hydrophilic interaction]	<ul style="list-style-type: none"> SeQuant® ZIC®-HILIC SeQuant® ZIC®-cHILIC SeQuant® ZIC®-pHILIC 	Mobile phase	80 % acetonitrile in water or dilute buffer

* When used in RP mode.

Column regeneration

Exposure of a column to samples or solvents containing highly adsorptive components will result in increased back-pressure and a change in selectivity. Often the column can be restored to original performance by suitable wash protocols. When performing solvent rinse regeneration, the column should be reversed and transferred from the analytical HPLC system to a simple, inexpensive pump. Alternatively, disconnect the column from the detector and rinse directly to waste. Each solvent should be rinsed with a minimum of 20, preferably 30, column volumes.

Separation mode	Phases	Wash sequence	Comments
RP [reversed-phase]	<ul style="list-style-type: none"> LiChrosorb® RP-8, RP-18, (DIOL, CN, NH₂)* LiChrospher® RP-8, RP-18, (DIOL, CN, NH₂)* Purospher® STAR RP-8e, RP-18e, Phenyl, (NH₂)* Chromolith® RP-8e, RP-18e, (DIOL, CN, NH₂)* 	<ul style="list-style-type: none"> Water Acetonitrile 2-Propanol + 0.1 % formic acid Heptane 2-Propanol + 0.1 % formic acid Acetonitrile Mobile phase 	* When used in RP mode.
NP [normal phase]	<ul style="list-style-type: none"> LiChrosorb® Si, DIOL, CN, NH₂ LiChrospher® Si, DIOL, CN, NH₂ Purospher® STAR Si, NH₂ Chromolith® Si, DIOL, CN, NH₂ 	<ul style="list-style-type: none"> Heptane Chloroform Ethanol or 2-propanol Chloroform Heptane Mobile phase 	Sequence of dry solvents
HILIC [hydrophilic interaction]	<ul style="list-style-type: none"> SeQuant® ZIC®-HILIC SeQuant® ZIC®-cHILIC SeQuant® ZIC®-pHILIC 	<ul style="list-style-type: none"> Water** 0.5 M NaCl or another salt Water Mobile phase 	** Double the initial water rinse

Calculation of column void time

Knowledge of the void time t_m (or void time V_m) is important for the calculation of chromatographic parameters like k and u . The void time may be calculated from the volume of the empty column V_{empty} , the volume flow f_c and the porosity of the carrier material. The total porosity of a column is the volume fraction occupied by the mobile phase.

$$e = V_m / V_{\text{empty}}$$
$$t_m = V_{\text{empty}} e / f_c$$

For totally porous materials like silica and modified silica, e is between 0.7 and 0.8. The void time may also be determined by measuring the retention time of non-retarded sample substances. Suitable substances for measuring the void time are:

Determination of column void time

Reversed-phase: UV detection: thiourea. RI detection: D_2O , CD_3OH , CD_3CN , eluent itself.

Normal phase: UV detection: benzene, tetrachloroethylene; RI detection: cyclohexane, benzene. When using very weak solvents, benzene and tetrachloroethylene may also be retained.

HILIC: toluene or naphthalene

How to use the right column

The fundamental equation for chromatographic resolution (R_s) is an aid for the selection of a suitable combination of stationary phase and column size.

$$R_s = \frac{1}{4} \left(\frac{k}{1+k} \right) \left(\frac{\alpha-1}{1+k} \right) \sqrt{N}$$

The calculation of the individual contributions under different conditions shows what influence the different parameters exert. Below table shows that with the correct choice of chromatographic system, good separations can be achieved even at relative low plate numbers. On the other hand even with extremely high plate numbers a satisfactory separation can not be obtained with poor separation factors.

Individual contributions of the chromatographic resolution

$k \left(\frac{k}{1+k} \right);$	$\alpha \left(\frac{\alpha-1}{\alpha} \right);$	$N \left(\frac{\sqrt{N}}{4} \right)$	R_s for N = 1,000	R_s for N = 5,000	R_s for N = 10,000
1 (0.5)	1.05 (0.05)	1,000 (7.9)	0.20	0.4	0.6
3 (0.75)		5,000 (17.7)	0.30	0.7	0.9
5 (0.83)		10,000 (25.0)	0.33	0.7	1.0
10 (0.91)				0.36	0.8
1	1.1 (0.09)		0.36	0.8	1.1
3			0.50	1.2	1.7
5			0.60	1.3	1.9
10			0.65	1.4	2.0
1	1.2 (0.16)		0.60	1.4	2.0
3			0.95	2.1	3.0
5			1.00	2.3	3.3
10			1.10	2.6	3.6
1	1.3 (0.23)		0.90	2.0	2.9
3			1.40	3.0	4.3
5			1.50	3.4	4.8
10			1.60	3.7	5.2
1	1.5 (0.33)		1.30	2.9	4.1
3			1.90	4.4	6.2
5			2.20	4.8	6.8
10			2.40	5.3	7.5

Empty column volumes

Column [length x i.d.]	Volume	Washing volume [10 column volume]
125 x 2 mm	0.4 mL	4 mL
250 x 2 mm	0.8 mL	8 mL
125 x 3 mm	0.9 mL	9 mL
250 x 3 mm	1.8 mL	18 mL
100 x 4.6 mm	1.7 mL	17 mL
125 x 4 mm	1.6 mL	16 mL
150 x 4.6 mm	2.5 mL	25 mL
250 x 4 mm	3.2 mL	32 mL
250 x 4.6 mm	4 mL	40 mL

Trouble-Shooting

Chromatographers frequently have to identify and rectify problems which can be divided in different categories. In this chapter, we will discuss some of the most common issues that may appear and how to solve them. Emphasis is on reversed phase separation. Often problems can be avoided by routine maintenance (e.g. planned replacement of worn out parts). Simple rules defined by J.W. Dolan are useful for classifying deficiencies and can help in avoiding follow-up mistakes.

Every market research report cites the reproducibility of selectivity as the most important column criterion; hence most manufacturers have made their best at validating their production processes. Nevertheless, small differences that exist in surface chemistry tend to appear at analysis of very sensitive samples. It is virtually impossible to eliminate all these during production in view of the variables involved: crude materials and reagents, surface binding chemistry, the packing process itself as well as the column packer, laboratory equipment and environment. In addition to this, the surface chemistry tends to change during column use. The bound phase is disintegrated, silica dissolves as silicate and the extended surface tends to adsorb impurities from sample and mobile phase. Therefore, these small differences have to be compensated for by the ruggedness of the method.

Contents

Retention

Problem: Changing retention times _____	389
Problem: Decreasing retention times _____	390
Problem: Increasing retention times _____	390

Equilibration

Problem: Slow column equilibration time _____	391
Problem: Varying retention times _____	391

Peaks

Problem: Broad peaks _____	391–392
Problem: Ghost peaks _____	392
Problem: Negative peaks _____	392
Problem: Peak doubling _____	393
Problem: Peak fronting _____	393
Problem: Peak tailing _____	394
Problem: Spikes _____	395
Problem: No peaks _____	395
Problem: Peaks with shoulders, split peaks _____	395

Recovery

Problem: Poor sample recovery _____	396
-------------------------------------	-----

Leaks

Problem: Leak at column or fittings _____	396
Problem: Leak at detector _____	396
Problem: Leak at injection valve _____	396
Problem: Leak at pump _____	396

Selectivity

Problem: Differences in selectivity _____	397
---	-----

Baseline

Problem: Disturbance at void time _____	397
Problem: Drifting baseline _____	397
Problem: Noise _____	398

Pressure

Problem: Decreasing pressure _____	398
Problem: Fluctuating pressure _____	399
Problem: High back-pressure _____	399

Retention

Small differences in mobile phase composition may cause huge differences in retention time when the column is overloaded and this also changes with temperature. However, even if the mobile phase is buffered and the pump is working properly, the retention times may fluctuate if the pH is too close to the pK of the sample substance. The pH of the mobile phase should therefore be chosen to be at least one pH unit above or below the pK value of the analytes being separated. **Retention time drift indicates insufficient column conditioning.** With increasing column life, the retention times may shift towards less retentivity, especially if the user is working at acidic pH (\leq pH 2). Abrupt changes in retention time are usually due to errors in the system.

Problem: Changing retention times

Possible cause	Solution
Flow rate variation	<ul style="list-style-type: none"> • Fix system leaks • Replace pump seals • Remove bubbles • Check for cavitations
Insufficient buffer capacity	<ul style="list-style-type: none"> • Use buffer concentration >20 mM and <50 mM
Column contamination build-up	<ul style="list-style-type: none"> • Flush column occasionally with strong solvent or regenerate the column
Equilibration time insufficient for gradient run or changes in isocratic mobile phase	<ul style="list-style-type: none"> • Allow at least 10 column volumes through the column for gradient regeneration or after solvent changes. True equilibration is achieved after 30 column volumes
First few injections – active sites	<ul style="list-style-type: none"> • Condition column by injecting concentrated sample
Inconsistent on-line mobile-phase mixing	<ul style="list-style-type: none"> • Ensure gradient system is delivering a constant composition • Compare with manually prepared mobile phase • Partially premix mobile phase. Avoid running from 100 % pure solvent to 100 % aqueous.
Selective evaporation of mobile-phase component	<ul style="list-style-type: none"> • Use closed solvent reservoirs • Use less-vigorous purging • Prepare fresh mobile phase • Check pump • Check frit • Avoid evaporation or degradation of mobile phase
Column temperature variation	<ul style="list-style-type: none"> • Thermostat or insulate column • Use column oven • Ensure constant laboratory temperature.
Column aging	<ul style="list-style-type: none"> • Replace column • If aging is premature, it may originate from sample matrix. Perform column regeneration • Use guard column

Trouble-Shooting

Retention

Problem: Decreasing retention times

Possible cause	Solution
Active sites on column packing	<ul style="list-style-type: none"> • Use mobile phase modifier • Competing base (basic compounds), or increase buffer strength • Use higher coverage column packing.
Column mass overload	<ul style="list-style-type: none"> • Decrease sample amount or use larger-diameter column
Increasing flow rate	<ul style="list-style-type: none"> • Check and reset pump flow rate.
Loss of bonded stationary phase	<ul style="list-style-type: none"> • Use mobile-phase pH that is within the specifications given for the particular column (normally between pH 2 and pH 7.5) with Purospher® STAR pH 1.5-10.5 is possible.
Column temperature variation	<ul style="list-style-type: none"> • Thermostat or insulate column • Use column oven • Ensure constant laboratory temperature.
Mobile phase composition changing	<ul style="list-style-type: none"> • Check pump • Check frit • Avoid evaporation or degradation of mobile phase
Column fouling	<ul style="list-style-type: none"> • Stationary phase modified by sample. Regenerate or change the column.

Problem: Increasing retention times

Possible cause	Solution
Decreasing flow rate	<ul style="list-style-type: none"> • Check and reset pump flow rate • Check for pump cavitations • Check for leaking pump seals and/or other leaks in system.
Changing mobile-phase composition	<ul style="list-style-type: none"> • Cover solvent reservoirs • Ensure that gradient system is delivering correct composition.
Loss of bonded stationary phase	<ul style="list-style-type: none"> • Use mobile-phase pH that is within the specifications given for the particular column (normally between pH 2 and pH 7.5). • With Purospher® STAR pH 1.5-10.5 is possible.
Mobile phase composition changing- online mixing	<ul style="list-style-type: none"> • Check pump • Check frit • Avoid evaporation or degradation of mobile phase
Failing or insufficient pH control for ionic compounds	<ul style="list-style-type: none"> • Use buffered mobile phases • Increase buffer concentration • Use buffer more suitable for required pH range
Temperature decreasing / Temperature variations in the column	<ul style="list-style-type: none"> • Use column thermostat
Column fouling	<ul style="list-style-type: none"> • Stationary phase modified by sample. Regenerate or change the column.

Equilibration

Problem: Slow column equilibration time

Possible cause	Solution
Reversed phase ion-pair reagents long chain ion-pair reagents require longer equilibration time	<ul style="list-style-type: none"> • Use ion-pair reagents with shorter alkyl chain length

Problem: Varying retention times

Possible cause	Solution
Gradient – insufficient column regeneration time	<ul style="list-style-type: none"> • Increase equilibration time (volume) with initial mobile-phase composition (A) to achieve constant retention for early peaks
Ion-pair reagents- insufficient equilibration time	<ul style="list-style-type: none"> • Increase equilibration time (volume) • Ion-pair reagents may require as much as 50 column volumes for mobile-phase changeover
Isocratic – insufficient equilibration time	<ul style="list-style-type: none"> • Pass 10-15 column volumes of mobile phase through column for equilibration

Peaks

If all peaks have same appearance in the chromatogram, the problem originated before the separation. If only some of the peaks or only one peak in the chromatogram elute with a distorted shape, the source is of chemical nature.

Problem: Broad peaks

Wide peaks are generated either by substantial influence on the part of the HPLC system (bad capillary connections, void volumes, too large detector cells or ill-chosen time constants) or by poor column performance.

Possible cause	Solution
Sample overload	<ul style="list-style-type: none"> • Dilute sample 1:10 with mobile phase and re-inject
Detector-cell volume too large	<ul style="list-style-type: none"> • Use smallest possible cell volume consistent with sensitivity needs • Use detector with no heat exchanger in system
Injection volume too large	<ul style="list-style-type: none"> • Decrease solvent strength of injection solvent to focus solute • Decrease injection volume • Dilute sample • Rule of thumb: Inject maximum 1 % of total column tube volume.
Large extra column volume	<ul style="list-style-type: none"> • Use low- or zero-dead-volume end-fittings and connectors • Use smallest possible diameter of connecting tubing (<0.10 in. i.d.) • Connect tubing with matched fittings
Mobile-phase solvent viscosity too high	<ul style="list-style-type: none"> • Increase column temperature • Change to lower viscosity solvent
Peak dispersion in injector valve	<ul style="list-style-type: none"> • Decrease injector sample loop size • Use segmented injection techniques (introduce air bubble in front and back of sample in loop)
Poor column efficiency	<ul style="list-style-type: none"> • Use smaller-particle-diameter packing, lower-viscosity mobile phase, higher column temperature, or lower flow rate
Retention time too long	<ul style="list-style-type: none"> • Use gradient elution or stronger isocratic mobile phase
Column head contaminated	<ul style="list-style-type: none"> • Exchange inlet frit or filter
Fouled or worn out column	<ul style="list-style-type: none"> • Regenerate column or replace with new column
Sampling rate of data system too low	<ul style="list-style-type: none"> • Increase sampling frequency

Trouble-Shooting

Peaks

Problem: Broad peaks [continued]

Possible cause	Solution
Slow detector time constant	<ul style="list-style-type: none"> Adjust time constant to match peak width
Column temperature too low	<ul style="list-style-type: none"> Increase column oven temperature
Some peaks broad – late elution of analytes retained from previous injection	<ul style="list-style-type: none"> Flush column with strong solvent at end of run End gradient at higher solvent concentration
Guard column/pre-column or column defective or soiled	<ul style="list-style-type: none"> Change guard column/pre-column or column
Sample dissolved in strong solvent	<ul style="list-style-type: none"> Dissolve sample in mobile phase
Wrong buffer pH	<ul style="list-style-type: none"> Test influence of eluent pH on peak shape
Buffer concentration too low	<ul style="list-style-type: none"> Use concentrated buffer or add salt to increase total ionic strength of the mobile phase
Extra column effects	<ul style="list-style-type: none"> Check capillary connections Use shorter capillaries with smaller i.d. Check for dead-volume
Leak between column and detector	<ul style="list-style-type: none"> Fix leak
Large detector cell	<ul style="list-style-type: none"> Use smaller cell
Sample incompatibility with system or sample precipitation	<ul style="list-style-type: none"> Use inert surfaces in system parts (injector, pump) Use simple test-tube experiment to determine solubility of sample in mobile phase to prevent on-column precipitation

Problem: Ghost peaks

Ghost peaks may be caused by unknown sample components, late eluting peaks from previous injections, impurities or mixing problems in connection with the mobile phase. The sample should therefore preferably always be dissolved in the eluent or in a solvent with weaker eluting strength. Substances with UV absorption lower than the eluent may generate negative peaks.

Possible cause	Solution
Elution of analytes retained from previous injection	<ul style="list-style-type: none"> Flush column with strong solvent at end of run End gradient at higher solvent concentration.
Ion-pair chromatography – upset equilibrium	<ul style="list-style-type: none"> Prepare sample in mobile phase Reduce injection volume
Oxidation of trifluoroacetic acid in peptide mapping	<ul style="list-style-type: none"> Prepare trifluoroacetic acid solutions fresh daily Use antioxidant
Unknown interferences in sample	<ul style="list-style-type: none"> Use sample cleanup or pre-fractionation before injection.
Column contamination	<ul style="list-style-type: none"> Flush column with strong solvent after each run Improve sample cleanup
Solvent impurities	<ul style="list-style-type: none"> Use HPLC-grade solvents

Problem: Negative peaks

Possible cause	Solution
Refractive index detection – refractive index of solute less than that of mobile phase	<ul style="list-style-type: none"> Reverse polarity to make peak positive
UV-absorbance detection – absorbance of solute less than that of mobile phase	<ul style="list-style-type: none"> Use mobile phase with lower UV absorbance If recycling solvent, stop recycling when recycled solvent affects detection

Problem: Peak doubling

If all peaks have shoulders or elute as double peaks, the cause may originate from clogged inline filters, column inlet frits, contaminated pre-columns or a void volume at the column head. In most cases, the column may be returned to its original state by cleaning or replacement of the inlet frit. A short-term solution to this problem may also be to invert the column. Destroyed bed at the column outlet contributes only marginally to peak spreading.

Possible cause	Solution
Blocked frit	<ul style="list-style-type: none"> • Replace or clean frit • Install 0.5-µm porosity in-line filter between pump and injector to eliminate mobile-phase contaminants or between injector and column to eliminate sample contaminants
Co-elution of interfering compound	<ul style="list-style-type: none"> • Use sample cleanup or pre-fractionation • Adjust selectivity by changing mobile or stationary phase
Co-elution of interfering compound from previous injection	<ul style="list-style-type: none"> • Flush column with strong solvent at end of run • End gradient at higher solvent concentration
Column overloaded	<ul style="list-style-type: none"> • Use higher-capacity stationary phase • Increase column diameter • Decrease sample amount
Column void or channelling	<ul style="list-style-type: none"> • Replace column
Injection solvent too strong	<ul style="list-style-type: none"> • Use weaker injection solvent or stronger mobile phase
Sample volume too large	<ul style="list-style-type: none"> • Use injection volume equal to 1 % of the total column tube volume when sample is diluted in mobile phase • Reduce sample volume • Dilute sample • Inject sample prepared in mobile phase
Sample dissolved in strong solvent	<ul style="list-style-type: none"> • Dissolve sample in mobile phase or (if not possible) inject very small sample volume

Problem: Peak fronting

Possible cause	Solution
Channelling in column	<ul style="list-style-type: none"> • Replace or repack column
Column overloaded	<ul style="list-style-type: none"> • Use higher-capacity stationary phase • Increase column diameter • Decrease sample amount • Dilute sample
Pre-column defective or soiled	<ul style="list-style-type: none"> • Change pre-column
Sample dissolved in wrong solvent	<ul style="list-style-type: none"> • Dissolve sample in mobile phase or (if not possible) inject smaller sample volume
Interfering compounds in the sample	<ul style="list-style-type: none"> • Test column using a test- or calibrations sample • Sample clean-up advised
Sample precipitation	<ul style="list-style-type: none"> • Use simple test-tube experiment to determine solubility of sample in mobile phase to prevent on-column precipitation

Trouble-Shooting

Peaks

Problem: Peak tailing

The tailing of peaks that are eluted early is caused by extra column effects. To remedy, the entire system should be checked – capillary connections, tubings and the detector cell. Secondary, non-specific interaction with the silica gel surface leads to a tailing of late eluting peaks and even to the appearance of double peaks. Addition of triethylamine or acetate to the mobile phase or selecting a suitable stationary phase will considerably improve the peak form. An inappropriately selected pH-value for the mobile phase may also lead to peak tailing. In principle, chromatography should be carried out one pH unit above or below the pK values of the sample substances.

Possible cause	Solution
Basic solutes – silanol interactions	<ul style="list-style-type: none"> • Use competing base such as triethylamine • Use a stronger mobile phase • Increase buffer or salt concentration (ion-pair-chromatography) • Use base-deactivated silica-based reversed-phase column • Use polymeric column • Use lower mobile phase pH
Chelating solutes – trace metals in base silica	<ul style="list-style-type: none"> • Use high purity silica-based column with low trace-metal content • Add EDTA or chelating compound to mobile phase • Use polymeric column
Silica-based column – degradation at high pH	<ul style="list-style-type: none"> • Use polymeric, sterically protected, or high-coverage reversed-phase column • Install silica gel saturator column between pump and injector
Silica-based column – degradation at high temperature	<ul style="list-style-type: none"> • Reduce temperature to less than 50°C
Silica-based column – silanol interactions	<ul style="list-style-type: none"> • Decrease mobile-phase pH to suppress silanol ionization • Increase buffer concentration • Derivatize solute to change polar interactions
Void formation at head of column	<ul style="list-style-type: none"> • Replace column • To prevent: Rotate injection valve quickly • Use injection valve with pressure bypass • Avoid pressure shock
Column overload	<ul style="list-style-type: none"> • Decrease sample size • Increase column diameter • Use higher capacity stationary phase
Blocked column frit	<ul style="list-style-type: none"> • Replace frit • Add in-line filter • Filter samples
Interfering compounds in the sample / Impurities	<ul style="list-style-type: none"> • Improve sample cleanup • Test column with test sample or calibrations sample • Use HPLC-grade solvents
Adsorption of the sample onto the column (especially basic compounds)	<ul style="list-style-type: none"> • Use a different stationary phase (special phase for basic compounds) • Use buffered mobile phase

Problem: Spikes

Possible cause	Solution
Bubbles in mobile phase	<ul style="list-style-type: none"> • Degas mobile phase • Use back-pressure restrictor at detector outlet • Ensure that all fittings are tight
Column stored without caps	<ul style="list-style-type: none"> • Store column tightly capped • Flush reversed-phase columns with degassed methanol

Problem: No peaks

Possible cause	Solution
No flow through detector; Leak	<ul style="list-style-type: none"> • Check pump • Check connections and fittings in the system and column end-fittings and tighten • Check frit • Check mobile phase composition • Fix leak
Sample injection is not reproducible	<ul style="list-style-type: none"> • Check sample injection system
No sample injected	<ul style="list-style-type: none"> • Make sure the injector is working properly and sample is not precipitated.
No detectability	<ul style="list-style-type: none"> • Make sure analytes are monitored under proper conditions

Problem: Peaks with shoulders, split peaks

Possible cause	Solution
Guard column defect or dirty	<ul style="list-style-type: none"> • Exchange guard column
Column head dirty	<ul style="list-style-type: none"> • Exchange inlet frit or filter
Dead space of column head or channels in column	<ul style="list-style-type: none"> • Use new analytical column
Sample dissolved in solvent which is not compatible with eluent.	<ul style="list-style-type: none"> • Dissolve sample in eluent • Decrease injection volume

Trouble-Shooting

Recovery | Leaks

Recovery

Problem: Poor sample recovery

Possible cause	Solution
Absorption or adsorption of proteins	<ul style="list-style-type: none">• Change HPLC mode to reduce non-specific interactions• Add protein-solubilising agent, strong acid or base (with polymeric columns only), or detergent such as SDS to mobile phase.
Adsorption on column packing	<ul style="list-style-type: none">• Increase mobile phase strength to minimize adsorption• For basic compounds add competing base or use base-deactivated packing
Adsorption on tubing and other hardware components	<ul style="list-style-type: none">• Use inert (PEEK), glass-lined, or titanium tubing and flow-path components
Chemisorptions on column packing	<ul style="list-style-type: none">• Ensure no reactive groups are present• Use polymeric packing• Change column type and mode
Hydrophobic interactions between stationary	<ul style="list-style-type: none">• Use short-chain reversed-phase packing• Use 300-Å pore diameter packing• Use hydrophilic packing or ion-exchange media• Use hydrophobic interaction chromatography
Less than 99 % yield for basic compounds irreversible adsorption on active sites	<ul style="list-style-type: none">• Use endcapped, base-deactivated, sterically protected, high coverage, or polymeric reversed-phase
Less than 90 % yield for acidic compounds – irreversible adsorption on active sites	<ul style="list-style-type: none">• Use endcapped or polymeric packing• Acidify mobile phase

Leaks

Problem: Leak at column or fittings

Possible cause	Solution
Loose fitting	<ul style="list-style-type: none">• Check connections and fittings in the system and column end-fittings and tighten or replace fitting
Precipitation (white powder) at loose fitting	<ul style="list-style-type: none">• Cut tubing and replace ferrule• Disassemble fitting, rinse and reassemble

Problem: Leak at detector

Possible cause	Solution
Detector-seal failure	<ul style="list-style-type: none">• Replace detector seal or gaskets

Problem: Leak at injection valve

Possible cause	Solution
Worn or scratched valve rotor	<ul style="list-style-type: none">• Replace valve rotor

Problem: Leak at pump

Possible cause	Solution
Pump-seal failure	<ul style="list-style-type: none">• Replace pump seal• Check piston for scratches and, if necessary, replace.

Selectivity

Problem: Differences in selectivity

Possible cause	Solution
Differences in mobile phase composition	<ul style="list-style-type: none"> • Check pump • Check frit • Avoid evaporation or degradation of mobile phase
New eluent composition is slightly different (i.e. pH is not adjusted, solvent contains contaminants)	<ul style="list-style-type: none"> • Make up new eluent • Accurately determine volume, salt addition and pH value
Too weak solvent/eluent not buffered	<ul style="list-style-type: none"> • Use buffer or ion-pair system
Sample dissolved in different solvents	<ul style="list-style-type: none"> • Dissolve sample in mobile phase or (if not possible) inject very small sample volume
Decreasing column life; Contamination	<ul style="list-style-type: none"> • Replace column • Improve sample cleanup • Check column with test mixture • Use HPLC-grade solvents
Temperature variations in the buffer	<ul style="list-style-type: none"> • Use column thermostat
Column to column reproducibility	<ul style="list-style-type: none"> • Replace column • Check with manufacturer
Column irreversibly changed	<ul style="list-style-type: none"> • Use new column

Baseline

Problem: Disturbance at void time

Possible cause	Solution
Air bubbles in mobile phase	<ul style="list-style-type: none"> • Degas or use back-pressure restrictor on detector
Positive-negative – difference in refractive index of injection solvent and mobile phase	<ul style="list-style-type: none"> • Normal with many samples • Use mobile phase as sample solvent

Problem: Drifting baseline

Possible cause	Solution
Negative direction (gradient elution) – absorbance of mobile phase A	<ul style="list-style-type: none"> • Use non-UV absorbing mobile phase solvents • Use HPLC grade mobile phase solvents
Positive direction (gradient elution) – absorbance of mobile phase B	<ul style="list-style-type: none"> • Use higher UV absorbance detector wavelength • Use non-UV absorbing mobile phase solvents • Use HPLC grade mobile phase solvents
Positive direction – contamination build-up and elution	<ul style="list-style-type: none"> • Flush column with strong solvent • Clean up sample • Use HPLC grade solvents
Wavy or undulating – temperature changes in room	<ul style="list-style-type: none"> • Monitor and control changes in room temperature • Insulate column or use column oven • Cover refractive index detector and keep it out of air currents.

Trouble-Shooting

Baseline | Pressure

Problem: Noise

Possible cause	Solution
Continuous – detector lamp problem or dirty flow cell	<ul style="list-style-type: none">• Replace UV lamp (each should last 2000 h)• Clean and flush flow cell
Gradient or isocratic proportioning – lack of solvent mixing	<ul style="list-style-type: none">• Use proper mixing device• Check proportioning precision by spiking one solvent with UV absorbing compound and monitor UV absorbance detector output
Gradient or isocratic proportioning – malfunctioning proportioning valves	<ul style="list-style-type: none">• Clean or replace proportioning precision valves• Partially remix solvents
Occasional sharp spikes – external electrical interference	<ul style="list-style-type: none">• Use voltage stabilizer for LC system• Use independent electrical circuit
Periodic – pump pulses	<ul style="list-style-type: none">• Service or replace pulse damper• Purge air from pump• Change piston seals• Clean or replace check valves.
Random – contamination build-up	<ul style="list-style-type: none">• Flush column with strong solvent• Clean up sample• Use HPLC grade solvent
Spikes – bubble in detector	<ul style="list-style-type: none">• Degas mobile phase• Use back-pressure restrictor at detector outlet
Spikes – column temperature higher than boiling point of solvent	<ul style="list-style-type: none">• Use lower column temperature

Pressure

Problem with pressure is usually connected with too high back-pressure, and to elucidate where the problem is originating, a good laboratory practice is to disconnect the system stepwise starting at the pump and working towards the detector.

Problem: Decreasing pressure

Possible cause	Solution
Insufficient flow to pump	<ul style="list-style-type: none">• Loosen cap on mobile phase reservoir
Leak in hydraulic lines from pump to column	<ul style="list-style-type: none">• Tighten or replace fittings• Tighten rotor in injection valve
Leaking pump check valve or seals	<ul style="list-style-type: none">• Replace or clean check valves• Replace pump seals.
Pump cavitations	<ul style="list-style-type: none">• Degas solvent• Check for obstruction in line from solvent reservoir to pump• Replace inlet-line frit

Problem: Fluctuating pressure

Possible cause	Solution
Bubble in pump	<ul style="list-style-type: none"> • Degas solvent • Purge solvent with helium
Leaking pump check valve or seals	<ul style="list-style-type: none"> • Replace or clean check valves • Replace pump seals

Problem: High back-pressure

Possible cause	Solution
Pre/guard column blocked	<ul style="list-style-type: none"> • Exchange pre/guard column • Exchange column inlet frit • Back-flush column • Exchange column
Column head blocked	<ul style="list-style-type: none"> • Change filter of column head • Flush column • Change column
Capillary blocked	<ul style="list-style-type: none"> • Exchange capillary
Column blocked with irreversibly adsorbed sample	<ul style="list-style-type: none"> • Improve sample cleanup • Use guard column • Reverse-flush column with strong solvent to dissolve blockage
Column particle size too small (for example 3 micrometers)	<ul style="list-style-type: none"> • Use larger particle size (for example 5 micrometer)
Microbial growth on column	<ul style="list-style-type: none"> • Use at least 10 % organic modifier in mobile phase • Use fresh buffer daily • Add 0.02 % sodium azide to aqueous mobile phase • Store column in at least 25 % organic solvent without buffer
Mobile phase viscosity too high	<ul style="list-style-type: none"> • Use lower viscosity solvents or higher temperature
Plugged frit in in-line filter or guard column	<ul style="list-style-type: none"> • Replace frit or guard column
Plugged inlet frit	<ul style="list-style-type: none"> • Replace end-fitting or frit assembly
Polymeric columns – solvent change causes swelling of packing	<ul style="list-style-type: none"> • Use correct solvent with column • Change to proper solvent composition • Consult manufacturer's solvent-compatibility chart • Use a column with a higher percentage of cross-linking
Salt precipitation (especially in reversed-phase chromatography with high concentration of organic solvent in mobile phase)	<ul style="list-style-type: none"> • Ensure mobile phase compatibility with buffer concentration • Decrease ionic strength and water-organic solvent ratio • Premix mobile phase
When injector disconnected from column – blockage in injector	<ul style="list-style-type: none"> • Clean injector or replace rotor



05

Preparative HPLC



www.merckmillipore.com/preparative-hplc

Whether you're scaling up to the production of chemicals and pharmaceuticals, or down to test their quality, you'll be well prepared with Merck Millipore. Our advanced preparative HPLC technology includes high performance sorbents and standardized silica gel packings made from consistent, high-quality raw materials. So you enjoy safe, fast and direct transfers either way.

05

Contents

Preparative HPLC	page 403
Aluminium oxide For preparative chromatography	page 404
Standardized silica gels	page 406
LiChroprep®	page 408
PharmPrep® P sorbent New high-performance spherical silica	page 410
Silanized silica	page 414
Micro-crystalline cellulose	page 415
Florisil®	page 416
Chromolith® Prep Chromolith® – increase in speed, efficiency and productivity	page 417
Hibar® pre-packed columns	page 418
Hibar® customized pre-packed columns 25 and 50 mm internal diameter	page 419
Scaling the separation	page 420

Preparative high performance liquid chromatography

Sorbents and columns

Preparative column chromatography plays an important role in purifying valuable compounds in research, pilot plant operation and production. The advantage of this method is that it delivers high levels of purity in a rapid and economical manner.

Merck Millipore is a specialist in the manufacture of standardized silica gel packing materials for preparative chromatography. We provide a wide range of products for the purification of APIs and intermediates designed to meet the special requirements of our customer's process: Silica Gel 60 is the right choice if you are looking for a reliable silica gel for simple adsorption processes and normal-phase chromatography. If you need a silica gel for advanced normal-phase and reverse-phase chromatography, we recommend using the irregular shaped LiChroprep® or the perfect spherical PharmPrep® – highly versatile materials providing fast, effective and reproducible separation. Our comprehensive product portfolio is completed by our high-quality Hibar® columns – delivered standardized, pre-packed and ready-to-use.

With regulatory demands growing steadily in the field of chromatography sorbents, it makes sense to work with a supplier who values control and quality as highly as you do – and who can provide the regulatory support you need for peace of mind. Merck Millipore is the biggest dedicated producer of chromatography-grade silica gels in the world – a huge number of process chromatographers use Merck Millipore silica gels in their daily work. They know that with the consistent high-quality of Merck Millipore sorbents, they can trust their results – today and tomorrow.

Aluminium oxide

For preparative chromatography

M. S. Tswett used aluminium oxide as a sorbent when he discovered chromatography in the year 1903. One year after his invention, Merck Millipore started to offer aluminium oxide for adsorption chromatography.

The aluminium oxide crystal structure comprises octahedrally and tetrahedrally coordinated aluminium coupled by oxygen atoms. The aluminium oxide surface is covered by free hydroxyl groups. There are different acidic and basic centers (Bronsted acid, Lewis acid and Lewis basic centers) that result in anion and cation exchange properties. Aluminium oxide exhibits a higher pH-stability than silica gel, especially in the alkaline range. Aluminium oxide occurs in various crystal modifications resulting in different pore diameters. Our offering comprises aluminium oxides with pore diameters of 6 nm, 9 nm and 15 nm.

Standardized aluminium oxide 90, for adsorption analysis according to Brockmann, is a sorbent of medium polarity. It is frequently used when the cation exchange properties of basic alumina are required. Furthermore, aluminium oxide may be used as an alternative to activated carbon, when the organic character of activated carbon can be problematic.

Typical technical data of aluminium oxide packing materials

Packing material	Characteristics	Spec. surface area S_{BET} [m ² /g]	Pore volume V_p [mL/g]	Particle size d_p [μm]	pH	Activity grade [Brockmann]
Aluminium oxide 60	irregular particles of alumina mean pore size: 6 nm (60 Å)	~160	0.3	63-200	9	I
Aluminium oxide 90	irregular particles of alumina mean pore size: 9 nm (90 Å)	90-120	0.3	63-200	4, 7, 9	I, II-III
Aluminium oxide 150	irregular particles of alumina mean pore size: 15 nm (150 Å)	60-90	0.3	63-200	9	I-II

Chromatographic results strongly depend on the water content of the sorbent. Water adsorbed on the sorbent surface reduces the activity, i.e. the adsorption strength of the adsorption sites. In the 1940's Brockmann and Schodder developed a method to determine a sorbent's activity by using various different dyes (Chem. Ber., 74B, 73 (1941)). They correlated sorbent activity to the retention factor (Rf) of these dyes. The table below shows the typical amounts of water that need to be added to a sorbent of activity I to reach the required Brockmann activity number.

Typical amounts of water to be added to a sorbent of activity I to reach the required Brockmann activity number

Water added [%]	Activity grade [Brockmann]	Retention factor [Rf] of dye
0	I	0.15
3	II	0.22
6	III	0.33
10	IV	0.44
15	V	0.65

Ordering information – Aluminium oxide packing materials

Product	Ordering No.	Contents	pH*	Activity grade [Brockmann]
Aluminium oxide 60, active, basic	1.01067.1000	1 kg	9	I
	1.01067.2000	2 kg		
Aluminium oxide 90, active, basic	1.01076.1000	1 kg	9	I
	1.01076.2000	2 kg		
	1.01076.9020	20 kg		
Aluminium oxide 90, active, neutral	1.01077.1000	1 kg	7	I
	1.01077.2000	2 kg		
	1.01077.9020	20 kg		
Aluminium oxide 90, active, acidic	1.01078.1000	1 kg	4	I
	1.01078.2000	2 kg		
	1.01078.9020	20 kg		
Aluminium oxide 90, standardized acc. to Brockmann	1.01097.1000	1 kg	9	II-III
	1.01097.5000	5 kg		
	1.01097.9050	50 kg		
Aluminium oxide 150, basic	1.01061.1000	1 kg	9	I-II
	1.01061.2000	2 kg		
Geduran® Aluminium oxide 90, standardized acc. to Brockmann	1.01060.9050	50 kg	9	II-III

*pH of 10 % aqueous suspension | Geduran® is an economical alternative to the more stringent specified items for production scale.

Standardized silica gels

Standardized silica gels from Merck Millipore are produced using a traditional method in the world's largest and most modern production plant for chromatography grade silica gels. Standardized silica gels are widely used in separation processes to purify high value compounds in ton quantities.

Standardized silica gels are available in many particle size ranges all derived from a single base silica gel, specifically produced only for adsorption and chromatography processes. Standardized silica gels offer easy development of your process from thin layer chromatography to any scale. Standardized silica gels are available in a wide variety of pack sizes from 500 g to 400 kg to suit your specific needs. Typically, bottles and drums out of pure HDPE are used that are approved for pharmaceutical and food applications.



► Lab Water Purification
Production of ultrapure
water suitable for HPLC
page 37

Typical technical data of standardized silica gel packing materials

Packing material	Characteristics	Spec. surface area S_{BET} [m ² /g]	Pore volume V_p [mL/g]	pH*	Water content [%]
Silica gel 60	irregular particles of silica; mean pore size: 6 nm (60 Å)	500	0.8	7.0	<7

*pH of 10 % aqueous suspension

Ordering information – Silica gel packing materials

Product	Ordering No.	Contents	Particle size [μm]	Particle size [mesh ASTM]
Silica gel 60	1.15111.1000	1 kg	15–40 μm	400–800 mesh
	1.15111.2500	2.5 kg		
	1.15111.9025	25 kg		
Silica gel 60	1.09389.1000	1 kg	35–70 μm	200–400 mesh
	1.09389.5000	5 kg		
	1.09389.9025	25 kg		
Silica gel 60	1.09385.1000	1 kg	40–63 μm	230–400 mesh
	1.09385.2500	2.5 kg		
	1.09385.5000	5 kg		
	1.09385.9025	25 kg		
Silica gel 60	1.07729.1000	1 kg	<63 μm	>230 mesh
	1.07729.5000	5 kg		
	1.07729.9025	25 kg		
Silica gel 60	1.15101.1000	1 kg	63–100 μm	170–230 mesh
	1.15101.9025	25 kg		
Silica gel 60	1.07733.0500	500 g	200–500 μm	35–75 mesh
	1.07733.1000	1 kg		
	1.07733.5000	5 kg		
	1.07733.9025	25 kg		
Silica gel 60	1.07734.1000	1 kg	63–200 μm	70–230 mesh
	1.07734.2500	2.5 kg		
	1.07734.5000	5 kg		
	1.07734.9025	25 kg		
Silica gel 60, extra pure	1.07754.0500	500 g	63–200 μm	70–230 mesh
	1.07754.1000	1 kg		
Silica gel 60, F ₂₅₄	1.10757.1000	1 kg	63–200 μm	70–230 mesh
Geduran® Silica gel 60	1.07027.1000	1 kg	25–45 μm	–
	1.07027.9025	25 kg		
Geduran® Silica gel 60	1.11567.1000	1 kg	40–63 μm	230–400 mesh
	1.11567.2500	2.5 kg		
	1.11567.9025	25 kg		
Geduran® Silica gel 60	1.10832.1000	1 kg	63–200 μm	70–230 mesh
	1.10832.2500	2.5 kg		
	1.10832.9025	25 kg		

Geduran® is an economical alternative to the more stringent specified items for production scale.



LiChroprep® is a proven, highly successful packing material providing fast, effective and reproducible separations. LiChroprep® is one of the most successful and reliable sorbents used in HPLC and medium pressure chromatography. It has a well documented history in the technical literature with several hundred applications described.

LiChroprep® is an irregular shaped silica gel packing material characterized by:

- A reproducible homogeneous silica gel matrix
- A narrow, well defined particle size distribution for high performance and high permeability
- Excellent selectivity and efficiency
- A large number of applications
- Large batch size
- Comprehensive regulatory documents are available

The totally porous irregular particles are tightly classified in the 15–25 µm, 25–40 µm and 40–63 µm ranges. LiChroprep® is available in ready-to-use Hibar® 250–25 mm columns as well as in different bulk pack sizes.

Typical technical data of LiChroprep® packing materials

Packing material	Characteristics	Spec. surface area S_{BET} [m ² /g]	Pore volume V_p [mL/g]	Particle size d_p [µm]	% C	Surface coverage [µmol/m ²]
LiChroprep® Si 60	irregular particles of silica; mean pore size: 6 nm (60 Å)	500	0.8	15–25 25–40 40–63	–	–
LiChroprep® NH ₂	irregular particles of silica with aminopropyl function	300	1.0	40–63	3.5	3.0
LiChroprep® DIOL	irregular particles of silica with vicinal hydroxyl function on C-chains; for special normal phase chromatography	300	1.0	40–63	7	3.9
LiChroprep® RP-18	irregular particles of silica with octadecyl derivative	300	1.0	15–25 25–40 40–63	16	3.0
LiChroprep® RP-8	irregular particles of silica with octyl derivative	500	1.0	40–63	13	3.4
LiChroprep® CN	Irregular particles of silica with cyanopropyl function on C-chains; for normal and reverse phase chromatography	300	1.0	40–63	6	3.8

► Lab Water Purification
Production of ultrapure water suitable for HPLC
page 37

Ordering information of LiChrorep® packing materials

Packing material	Ordering No.	Contents	Particle size
LiChrorep® Si 60	1.09336.1000	1 kg	15-25 µm
	1.09336.9025	25 kg	
LiChrorep® Si 60	1.09360.1000	1 kg	25-40 µm
LiChrorep® Si 60	1.13905.0250	250 g	40-63 µm
	1.13905.1000	1 kg	
LiChrorep® RP-18	1.13901.0100	100 g	15-25 µm
	1.13901.0500	500 g	
	1.13901.9010	10 kg	
LiChrorep® RP-18	1.09303.0100	100 g	25-40 µm
	1.09303.0500	500 g	
	1.09303.5000	5 kg	
	1.09303.9025	25 kg	
LiChrorep® RP-18	1.13900.0250	250 g	40-63 µm
	1.13900.1000	1 kg	
	1.13900.9025	25 kg	
LiChrorep® RP-8	1.09362.0250	250 g	40-63 µm
	1.09362.1000	1 kg	
LiChrorep® DIOL	1.13973.0250	250 g	40-63 µm
LiChrorep® NH ₂	1.13974.0250	250 g	40-63 µm
LiChrorep® CN	1.13959.0250	250 g	40-63 µm

PharmPrep® P sorbent

New high-performance spherical silica

PharmPrep® P sorbent is the latest development in Merck Millipore's silica sorbent range. The particles have a perfect spherical shape and are available in two particle sizes: 10 and 20 µm. Together with a pore diameter of 100 Å (10 nm), these new sorbents fit perfectly into the polishing step of small peptides like insulin, and other biopharmaceutical and pharmaceutical APIs like antibiotics and hormones. This highly porous silica is produced by spray drying. Because Merck Millipore performs the entire manufacturing process, you benefit from consistent batch-to-batch purification, while ensuring superior quality standards and regulatory compliance.

PharmPrep® P sorbent for preparative liquid chromatography (LC)

PharmPrep® P sorbent is a spherical, porous silica carrier characterized by:

- Uniform and homogenous silica gel matrix with excellent batch-to-batch reproducibility
- Narrow particle size distribution for high performance and high packing stability
- Reproducible specific surface area and pore size distribution
- Enhanced mechanical stability
- General high-manufacturing quality and reproducibility





Ordering information of PharmPrep® P sorbent packing materials

Packing material	Ordering No.	Contents	Particle size
PharmPrep® P Si100	1.19681.0010	10 g	10 µm
	1.19681.0100	100 g	
	1.19681.1000	1 kg	
PharmPrep® P Si100	1.19682.0010	10 g	20 µm
	1.19682.0100	100 g	
	1.19682.1000	1 kg	
PharmPrep® P 100 RP-8e	1.19132.0010	10 g	10 µm
	1.19132.0100	100 g	
	1.19132.1000	1 kg	
PharmPrep® P 100 RP-18e	1.19995.0010	10 g	10 µm
	1.19995.0100	100 g	
	1.19995.1000	1 kg	
PharmPrep® P 100 RP-18e	1.19996.0010	10 g	20 µm
	1.19996.0100	100 g	
	1.19996.1000	1 kg	



Ordering information of PharmPrep® P – Scout columns 250–4.6 mm

Packing material	Ordering No.	Particle size
PharmPrep® P 100 RP-18e	1.20571.0001	10 µm
PharmPrep® P 100 RP-18e	1.20572.0001	20 µm
PharmPrep® P 100 RP-8e	1.20581.0001	10 µm
PharmPrep® P 300 RP-4e	1.20575.0001	10 µm



Ordering information of PharmPrep® P – Ready-to-use HPLC columns, Hibar® pre-packed columns 250–25 mm

Packing material	Ordering No.	Particle size
PharmPrep® P 100 RP-18e	1.20573.0001	10 µm
PharmPrep® P 100 RP-18e	1.20574.0001	20 µm
PharmPrep® P 100 RP-8e	1.20587.0001	10 µm

Hibar® pre-packed column 250–50 mm on request

Polishing of Insulin

As seen in the figure, PharmPrep® P sorbent demonstrates a perfect separation of the insulin and the main impurities desamido-insulin. With this polishing step using PharmPrep® P sorbent, a final outstanding insulin purity of 99.8 % can be achieved.

PharmPrep® P 100 RP-18e, 10 µm sorbent,
chromatographic conditions for polishing of crude human insulin (90 % pure)

Column	Purospher® STAR, 5 µm, 250 x 4.6 mm
Mobile phase	A: 0.1 M NH ₄ H ₂ PO ₄ pH 7.3 B: 0.1 M NH ₄ H ₂ PO ₄ pH 7.3/ACN 5/5 v/v
Gradient	65 % A – 30 % A 100 min
Flow rate	1.325 mL/min
Detection	UV 214 nm
Column temperature	25°C
Injection volume	100 µL
Sample	18 mg/mL crude human Insulin rec. dissolved in water + 0.1 % TFA

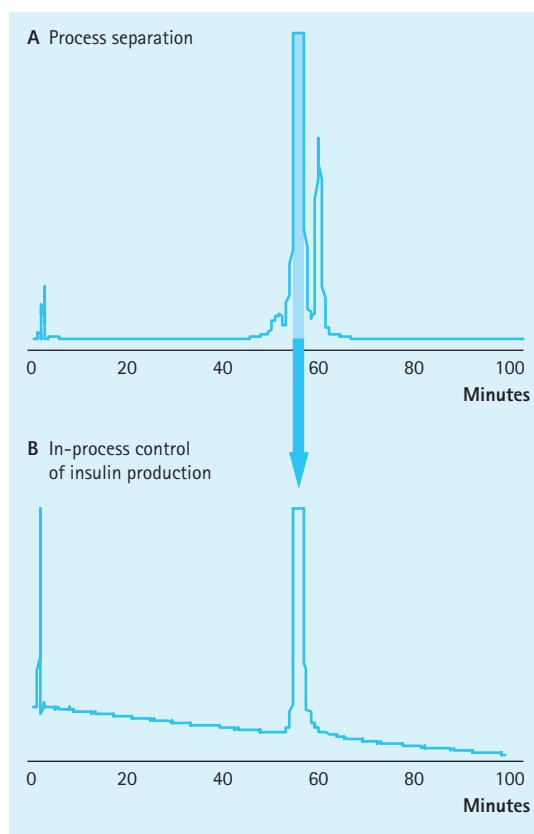



Preparative HPLC

Silanized silica

Silanized Silica 60 is an alternative material for the economic purification of products, where conventional RP-phases are too expensive. Derivatized silica gels show high loading capacities due to the high specific surface area of the basic silica 60.

Typical technical data of Silica gel 60 silanized

Packing material	Characteristics	Spec. surface area S_{BET} [m^2/g]	Pore volume V_p [mL/g]	Particle size d_p [μm]
Silica 60 silanized	irregular particles of silica; mean pore size: 6 nm (60 Å)	500	0.8	63-200

Ordering information – Silica 60 silanized

Product	Ordering No.	Particle size	Particle size distribution	Quantity
Silica gel 60 silanized (dimethylsilane derivate)	1.07719.0250	63-200 μm	70-230 mesh ASTM	250 g
Silica gel 60 silanized (dimethylsilane derivate)	1.07719.1000	63-200 μm	70-230 mesh ASTM	1 kg

Micro-crystalline cellulose

Micro-crystalline cellulose is a hydrophilic polysaccharide packing material preferred for the raw separation of amino acids and related compounds. Cellulose is also used for the gentle purification of bio-molecules. Because of the organic nature of cellulose, it can only be used in pre-swollen state and under gentle or hydrostatic pressure.

Ordering information – Cellulose packing materials

Product	Ordering No.	Particle size	Quantity
Cellulose micro-crystalline Avicel®	1.02331.0500	20-160 µm	500 g
Cellulose micro-crystalline Avicel®	1.02331.2500	20-160 µm	2.5 kg
Cellulose micro-crystalline Avicel®	1.02331.9025	20-160 µm	25 kg



► Lab Water Purification
Production of ultrapure
water suitable for HPLC
page 37

Florisil® is a polar highly selective magnesium silicate of the approximate composition MgO/SiO₂ (15/85) which is particularly suitable for the separation of steroids, alkaloids, antibiotics etc. This stationary phase is also used for the sample preparation of environmental samples such as pesticide residue analysis, chlorinated hydrocarbons and pesticides.

For sample preparation in the case of pesticides, a specially purified and activated Florisil® (Cat. No. 112994) is often used. **Activation temperature 675°C as used for Florisil (Cat. No. 112994) gives a highly active form. Florisil® (Cat. No. 112518) activated at 650°C is a less active material.**

Typical technical data of Florisil® packing materials

Composition	MgO 15.5 % / SiO ₂ 84.0 % / Na ₂ SO ₄ 0.5 %
pH	8.5
S_{BET}	300 m ² /g
Specific weight	2.5 g/mL
Porosity	56 %
Surface acidity (PK.)	1.5

Ordering information – Florisil®

Product	Ordering No.	Particle size	Particle size distribution	Quantity
Florisil®	1.12518.0100	150-250 µm	60-100 mesh ASTM	100 g
Florisil®	1.12518.1000	150-250 µm	60-100 mesh ASTM	1 kg
Florisil® for residual analysis	1.12994.0100	150-250 µm	60-100 mesh ASTM	100 g
Florisil® for residual analysis	1.12994.1001	150-250 µm	60-250 mesh ASTM	1 kg

Chromolith® Prep

Chromolith® – increase in speed, efficiency and productivity

Please have a look at the Chromolith® Prep pages in the analytical HPLC chapter on page 254 for more detailed information on technical data and separation examples.

Separation of α - and δ -Tocopherol from sunflower oil at different flow rates

Chromolith® Prep 100–25 mm, flow rate 40 mL/min

Column	Chromolith® Prep 100-25 mm
Solvent	n-Heptane / Dioxane (80/20 v/v)
Flow rate	40 mL/min
Sample	Sunflower oil

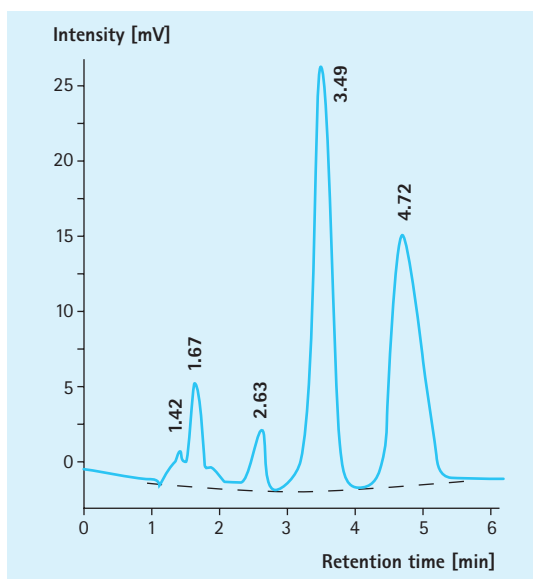

Chromolith® Prep 100–25 mm, flow rate 160 mL/min

Column	Chromolith® Prep 100-25 mm
Solvent	n-Heptane / Dioxane (80/20 v/v)
Flow rate	160 mL/min
Sample	Sunflower oil

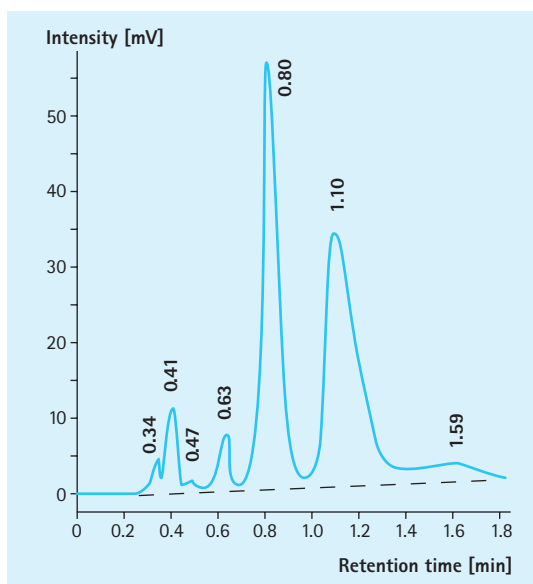

► Lab Water Purification
Production of ultrapure
water suitable for HPLC
page 37

► Chromolith® RP-18
endcapped Chromolith®
RP-18 endcapped col-
umns are the fastest C18
columns in the world.
page 214

► Chromolith® Si
page 238

Hibar® pre-packed columns

After a separation has been optimized with an analytical column, the method parameters can be easily transferred by using a pre-packed Hibar® column with an internal diameter of 25 mm or 50 mm. This size is convenient for separations of mg up to grams range of final product. Hibar® pre-packed columns are "ready-to-use" and can easily be connected to any HPLC system, using standard 1/16" capillary male connectors at both ends. An extensive range of PharmPrep® or LiChroprep® sorbents are available. The sorbents produced by Merck Millipore are subjected to the most stringent controls; many different parameters are tested for each sorbent. These have proven their performance over many years.



Hibar® column 250-25 mm



Ordering information of PharmPrep® P – Ready-to-use HPLC columns, Hibar® pre-packed columns 250-25 mm

Packing material	Ordering No.	Particle size
PharmPrep® P 100 RP-18e	1.20573.0001	10 µm
PharmPrep® P 100 RP-18e	1.20574.0001	20 µm
PharmPrep® P 100 RP-8e	1.20587.0001	10 µm

[Hibar® pre-packed column 250-50 mm on request](#)

Ordering information – Hibar® pre-packed columns, 25 mm internal diameter

Sorbent	Ordering No.	Particle size	Dimension length	Dimension i.d.	Contents of one package
LiChrospher® 100 RP-8	1.51482.0001	5 µm	250 mm	25 mm	1 column, 2 connectors 1/8"-1/16"
LiChrospher® 100 RP-18	1.51483.0001	5 µm	250 mm	25 mm	1 column, 2 connectors 1/8"-1/16"
LiChrospher® 60 RP-select B	1.51484.0001	5 µm	250 mm	25 mm	1 column, 2 connectors 1/8"-1/16"
LiChrospher® Si 60	1.51485.0001	5 µm	250 mm	25 mm	1 column, 2 connectors 1/8"-1/16"
LiChrospher® 100 RP-18e	1.51478.0001	5 µm	250 mm	25 mm	1 column, 2 connectors 1/8"-1/16"

▶ **Lab Water Purification**
Production of ultrapure water suitable for HPLC
page 37

▶ **Purospher® STAR RP-18 endcapped**
The versatility you need!
page 269

▶ **Purospher® STAR RP-8 endcapped** Ideal for less hydrophobic compounds
page 283

▶ **Purospher® STAR Si (Silica) and NH₂ (Amino-phase)**
page 289

▶ **Superspher®**
Silica carrier for highly efficient separations
page 308

▶ **LiChrospher®**
Silica carrier for constant top-rate results
page 312

▶ **LiChrosorb®**
Irregular shaped silica sorbent
page 342

▶ **PharmPrep® P sorbent**
New high-performance spherical silica
page 410

Hibar® customized pre-packed columns

25 and 50 mm internal diameter

If you require the versatility to quickly change columns but you prefer to purchase "ready to use" columns with specific sorbents, customized packing columns provide the perfect answer.

Sorbents for universal and specific applications are available

- LiChrospher® and LiChroprep® packing materials for standard and specific applications are available
- Batch-to-batch reproducibility is our constant goal
- Columns are available with 25 and 50 mm internal diameter and in different lengths
- Short delivery times



Ordering information – HiBar® customized pre-packed columns

Sorbent	Ordering No.	Dimension length	Dimension i.d.	Contents of one package
Customized packing for RP-materials	1.50099.0001	250 mm	50 mm	1 column, connection set
Customized packing for Si, CN, DIOL, NH ₂ materials	1.50092.0001	250 mm	50 mm	1 column, connection set
Customized packing	1.50004.0001	250 mm	25 mm	1 column, 2 connectors 1/8"-1/16"

► Lab Water Purification
Production of ultrapure water suitable for HPLC
page 37

► HiBar® pre-packed columns
page 375

Scaling the separation

Whenever there is a need to transfer an HPLC method from one column dimension to another, from one sorbent particle size to another, or from one type of HPLC instrumentation to another (e.g. analytical to semi-preparative/preparative scale or analytical to capillary/nano-scale), many parameters need to be taken into consideration.

To be successful in scaling the separation, physical parameters such as flow rate, tubing inner diameter, detector cell volume, and injection volume (among others) need to be scaled appropriately to avoid introducing extra-column effects which prevent maintaining the integrity of the separation as it is scaled.

The VanDeemter plot for different particle sizes at different linear velocities

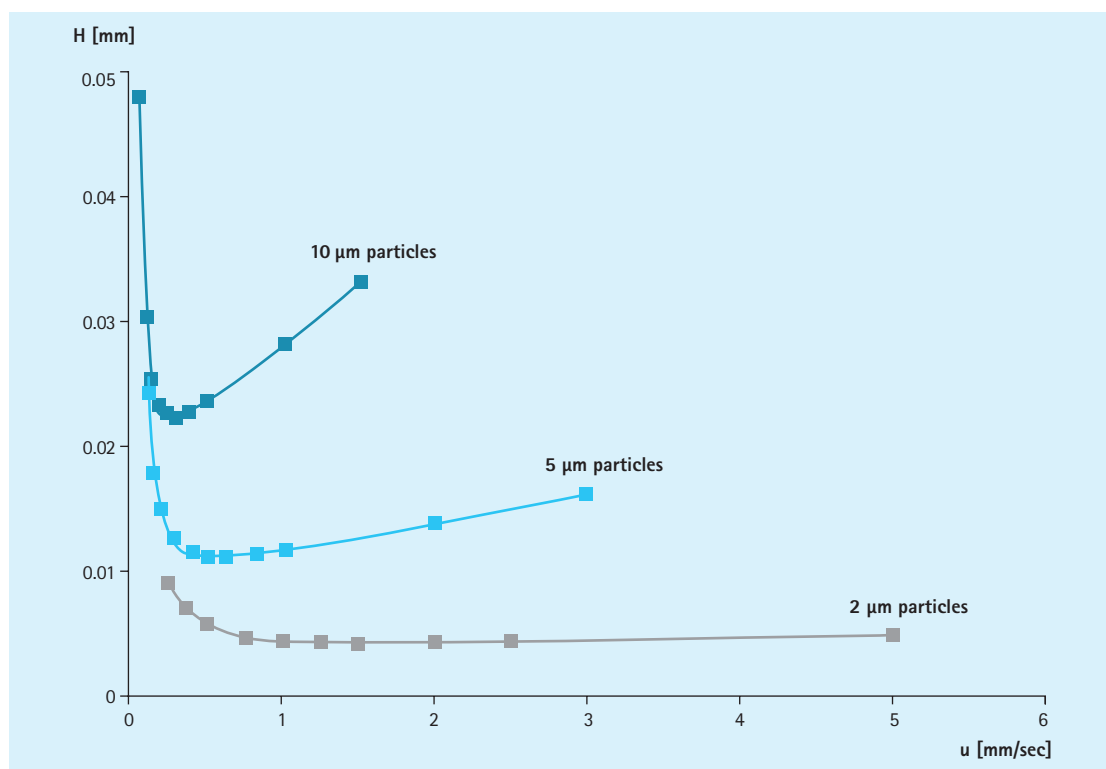

Flow rate as a function of the column inner diameter (i.d.) at the same constant linear velocity

Column i.d.	Flow rate
50 mm	120 mL/min
25 mm	30 mL/min
10 mm	5 mL/min
4.6 mm	1 mL/min
3.0 mm	0.4 mL/min
2.1 mm	0.2 mL/min
1.0 mm	0.05 mL/min

► Lab Water Purification
Production of ultrapure
water suitable for HPLC
page 37

Down-scaling

When scaling down a separation, extra-column volumes need to be carefully considered and minimized as much as possible to avoid loss of separation power (i.e. efficiency and resolution). The starting column dimensions may differ depending on the application and common practices of the laboratory.

For example, chromatographers performing quality control of pharmaceuticals often use long (150 or 250 mm) columns with 4.6 mm i.d. combined with standard UV or RI detectors. They may want to optimize the robustness and throughput of their methods by scaling down to a 3.0 or 2.1 mm i.d. column of the same or shorter length.

Other chemists may already be working with a 2.1 or 1.0 mm i.d. column method, and want to transfer it to capillary dimensions, which also requires changing the type of HPLC system used as well. In this case, many instrumentation considerations become critical as well as those required to just scale down the column dimensions on the same HPLC system. For example, factors such as optimum sample loading mass must be taken into account, as it is a function of the cross sectional area of the column.

Volume of 10 cm lengths of the most common HPLC tubing inner diameters (i.d.)

Tube i.d. [mm]	Tube [color]	Volume [inch]	Volume [μ L]
0.064	natural	0.025	0.32
0.13	red	0.05	1.3
0.17	yellow	0.07	2.3
0.25	blue	0.10	4.9
0.50	orange	0.20	20

If you consider scaling down your separation from an analytical 4.6 mm i.d. column, a good alternative is to choose 3.0 mm i.d. columns as they will provide high sensitivity and substantial solvent saving (almost 60 % reduction) without the need to change the existing equipment settings. The effect from extra-column void volume is negligible in this case.

If there is a wish to save solvent, achieve higher sensitivity, and/or if the sample amount is limited, narrower i.d. columns (i.e. 2.1 or 1.0 mm i.d.) are the more proper choice. When using a 2.1 or 1.0 mm i.d. column with the same length as a 4.6mm i.d. column, the solvent savings are about 80 % or 95 %, respectively. The chromatographer, however, needs then to change to narrower i.d. tubing in the system, and also change from standard to semi-micro/micro flow cells when using UV detectors in order not to lose chromatographic efficiency. You don't want the detector flow cell or extra-column tubing in the system to become "mixing chambers" and undo the hard work of your method development resolution efforts as your analytes elute.

Scaling the separation

Decreased efficiency | Injection volumes

Decreased efficiency with a large void volume

The void volume, also referred to as the dead volume, is the total volume of liquid between the injector and the detector. The size of the void volume determines the time (t_0) for a compound that is not retained on the separation material, to reach the detector.

The void volume (V_{void} or V_0) is the sum of the volume inside and outside the column.

$$V_0 = V_{\text{void}} = V_{\text{column}} + V_{\text{extra}}$$

The void volume of the column (V_{column}) is the volume between and within the pores of the individual particles, which in total form the packing material of the column. For a fixed column size, the column void volume is practically constant and independent of the diameter of the packed particles. An important source of band-broadening is, however, the volume outside the column (V_{extra}), i.e. the volume in the injection loop, the interconnecting tubing, and the detector.

All tubing used to connect the components of the system should be short, while having the smallest possible inner diameter, to minimize the band-broadening and not to destroy the efficiency obtained by a high quality column. Of course, decreasing the tubing's inner diameter has a practical limit, as the back-pressure and the risk of unintentional clogging increases accordingly. The volume between the pump and the injector is obviously of no consequence to band broadening, but it can nevertheless be impractical if it is excessive, since eluent changeover might take an unnecessarily long time.

Injection volumes

Sample injection volumes ranging from 1 to 100 μL are commonly used for analytical separations, for guidelines see the table below. When injecting fixed volumes through injection loops, minimal band broadening is obtained using longer tubes with smaller inner diameters.

In a tube with laminar flow, dispersion is proportional to the square root of the length and the square of the tube radius respectively. This is why a tube with a small inner diameter gives less band-broadening.

Suitable injection volumes
for different column inner diameters

Column i.d.	Sample volume
1 mm	0.05-1 μL
2 mm or 2.1 mm	0.2-5 μL
3 mm	1-20 μL
4 mm or 4.6 mm	5-80 μL
7.5 mm	10-150 μL
10 mm	30-500 μL
25 mm	200-3000 μL

Volume overload

Injections of excessive sample volumes will cause volume overload that will significantly decrease the separation efficiency. In extreme cases a volume overload can give flattened and grossly distorted peaks, as illustrated in the figure.

Overlay of chromatograms with increasing injection volumes

Column	50 x 4.6 mm, 5 μ m particles
Injection volumes	3 μ L 20 μ L 200 μ L

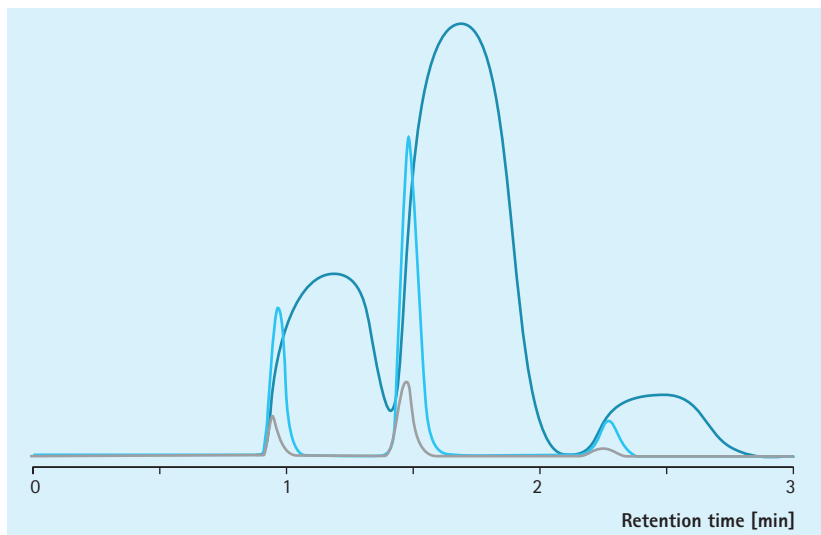

Separation efficiency

To preserve maximum separation efficiency, injection volumes should not exceed 1 % of the total column volume, have a look at the figure. Also note that if 10 % of the total column volume is injected, only about 20 % of the column efficiency will remain.

Column efficiency for different injection volumes

Column	50 x 4.6 mm
Mobile phase	Analyte $k = 1.6$

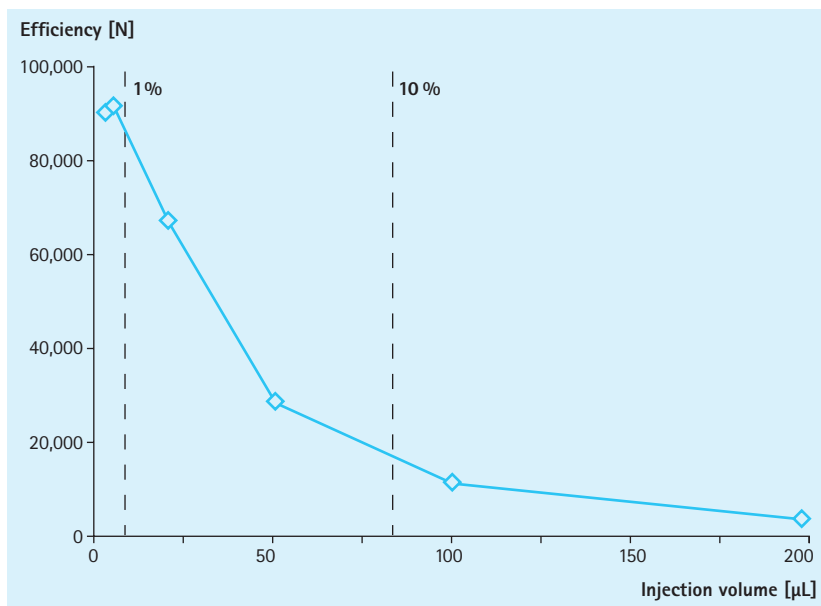

Scaling the separation

Mass overload

Mass overload

Injection of excessive sample mass (as differentiated from excessive sample volume) will also cause overload, which significantly decreases the separation efficiency, although in a different way. Mass overload leads to shortened retention times as well as causing non-Gaussian peaks, as illustrated in figure.

Mass overload also occurs with increasing amounts of analytes in the injected sample. The table shows recommended mass loadings per column i.d. Eluting peaks with relatively much smaller mass amounts display Gaussian shapes, but with increasing mass loading the eluting peaks assume a triangular, Langmuir (left-angled) or anti-Langmuir (right-angled) shape. This is due to the non linear part of the adsorption isotherms (non-linear chromatography). Preparative chromatography is normally deliberately carried out under overloading conditions, as opposed to analytical separations, in which the peaks retain Gaussian shapes within the linear part of the adsorption isotherm.

Recommended mass loads

Column i.d.	Sample amount
1 mm	0.05 mg
2 mm or 2.1 mm	0.2 mg
3 mm	1 mg
4 mm or 4.6 mm	5 mg
7.5 mm	10 mg
10 mm	30 mg
25 mm	200 mg

Recommended mass loads with no negative influence on the analytical column separation efficiency. The mass loadability ultimately depends on the sample complexity, solubility and retentivity, hence both less and more mass is possible to load at each column i.d.

Retention of Para-aminobenzoic acid on Chromolith® RP-18 endcapped, 100-10 mm

Column	Chromolith® RP-18 endcapped 100-10 mm
Mobile phase	Acetonitrile:water / 5:95 (v/v) Acetic acid 0.1 %
Injection volume	200 µL
Sample	Dissolved in mobile phase and concentrations ranging from 0.1-50 mg/mL

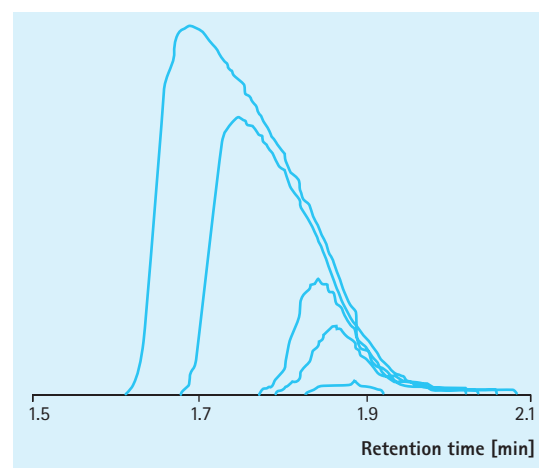

Scaling the column length

Scaling of a separation may also involve scaling of the column length, either to shorten the injection-to-injection cycle time of the assay by reducing the column length, or to achieve higher peak capacity and to be more tolerable of matrix effects. The figure illustrates separations with similar column efficiency. With a shorter column the separation is quicker, and with a longer column you can expect higher resolution and more peak capacity.

Separation of toluene, uracil and cytosine on a ZIC®-HILIC column (4.6 mm i.d.)

Column	ZIC®-HILIC 4.6 mm
Mobile phase	Acetonitrile 80:20 (v/v) / Ammonium acetate buffer 25 mM, pH 6.8
Flow rate	0.5 mL/min
Sample	Toluene Uracil Cytosine

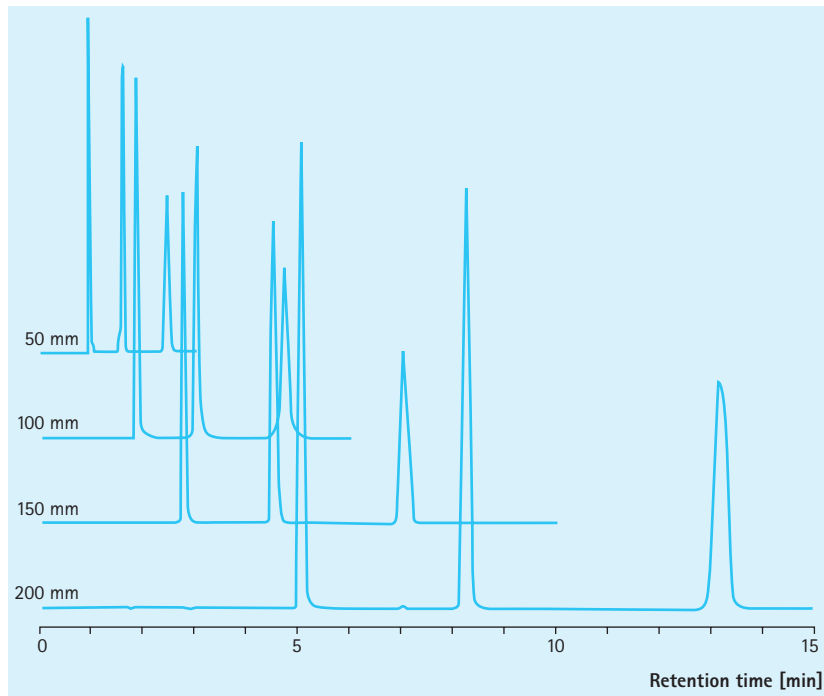

Instrumental influence

When scaling down, it is important to identify and adjust for potential instrumentation influence. In gradient mode, the user should pay attention to the overall system dwell volume, where the pump mixer may contribute a very large extra volume. This could potentially ruin any attempts in scaling a separation, with delay in the gradient profile. This effect is larger the more narrow a column i.d. is used. However, it can easily be alleviated by simply replacing the standard mixer with a smaller volume one.

Other than the potential gradient errors discussed above, the pump mixer has little influence on the chromatographic efficiency. This is not the case for detectors. In liquid chromatography, the detector is a flow-through unit, and both the actual detection technology and the design of the detector will influence the column separation capability.

The figure illustrates the result from a standard HPLC system equipped with a UV-detector operated at 0.1 mL/min and using a 150x2.1 mm column. Different injection volumes were used, 5 and 10 μL , which correspond to one and two percent of the total column volume, respectively. Both a standard (8 μL) and a semi-micro flow cell (2.5 μL) were used. For 2.1 mm and smaller i.d. columns, it is recommended to use semi-micro flow cells, whereas from 3.0 up to 7.5 mm i.d., a standard flow cell is recommended. For larger column i.d., a preparative flow cell should be used of larger volume.

Extra-column volume effects of injection and detector flow cell volumes

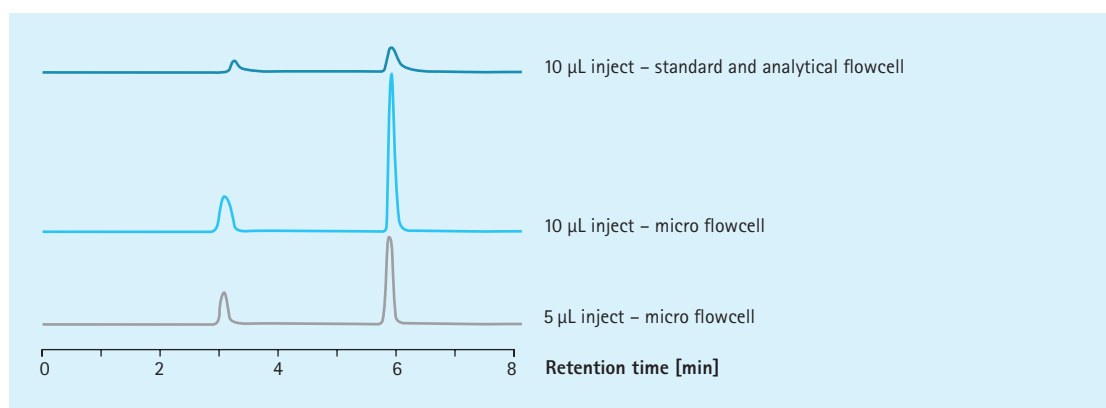

All experiments were performed on the same system using a 150-2.1 mm long column.

Up-scaling

Preparative HPLC is an indispensable tool to purify compounds for activity testing during the discovery and development process of new drugs. Depending on the amount, semi-preparative HPLC can be carried out at analytical scale on columns with 5 mm i.d. or less, or at preparative scale on much larger columns. Converting from analytical to preparative scale is often seen as a complicated and tiresome task by many users. The common view is that separation and performance for preparative HPLC columns is inferior to analytical columns. This is mainly true historically, but today several manufacturers offer truly scalable phases.

The traditional way of making an HPLC column involves slurry packing using pressure driven pumps where often the performance (both efficiency and peak asymmetry) of analytical and preparative columns differs. Slurry packing techniques suffer from friction from the column walls and how the friction helps stabilize the packed bed. Large diameter columns have less surface area per gram of stationary phase to hold it in place during the slurry decompression step. This results in reduced density and performance in the preparative columns and traditionally this makes the use of high efficiency 5 μm silica particles ineffective. Instead, 10 μm or larger materials are generally used for preparative separations.

In semi-preparative/preparative/process mode, the actual separation is mostly carried out under overload conditions (both volume and mass overload), to maximize productivity, hence it is important to have confidence that the analytical column will scale accordingly. Commonly, loadability studies are carried out in the analytical scale, to demonstrate overloading conditions and that the overloaded method will predictably scale to the larger preparative column.

There are also the obvious economical reasons for performing the initial loading studies in the analytical scale. It is more expensive to run loading studies in preparative scale: the instrumentation is more expensive; it consumes more solvents per separation and it often requires multiple injections thereby decreasing the amount of sample recovered. Though the transposed large scale method is a good starting point, at times the preparative method may need to be modified for improved efficiency. As a result, large scale separation on a preparative HPLC system can require more of the chemist's time to determine efficient loading. It is also important to keep in mind that method development or method transposition from an analytical platform to a preparative system is not always consistent due to the differences in performance of high pressure systems, column vendors, column size, and media size and type.

Scaling the separation

Scale-up calculations

Scale-up calculations

There are different ways to calculate scaling up from one column to another. The equation represents one alternative.

$$\frac{X_{an}}{\pi r_{an}^2} = \frac{X_{pr}}{\pi r_{pr}^2} \cdot \frac{1}{c_L}$$

X_{an}	Flow rate in the analytical system	
X_{pr}	Flow rate in the preparative system	$X_{pr} = X_{an} \cdot r_{pr}^2 \cdot c_L / r_{an}^2$
r_{an}	Radius of analytical column	
r_{pr}	Radius of preparative column	
c_L	Length of the preparative column to length of the analytical column	
M	Substance mass	$M_{pr} = M_{an} \cdot r_{pr}^2 \cdot c_L / r_{an}^2$

Linear scaling from analytical to preparative/process scale at three different flow rates

Dimension length and inner diameter [mm]	Flow rate 1	Flow rate 2	Flow rate 3
250-4 mm	0.5 mL/min	1 mL/min	2 mL/min
250-25 mm	19.5 mL/min	39 mL/min	78 mL/min
250-50 mm	78 mL/min	156 mL/min	312 mL/min
250-100 mm	312 mL/min	625 mL/min	1250 mL/min
250-200 mm	1250 mL/min	2500 mL/min	5000 mL/min
250-300 mm	2812 mL/min	5625 mL/min	11250 mL/min

Practical examples of analytical and preparative scale purification

In the following section, examples are given for analytical separations scaled to larger scales.

The first example is scaling from 4.6 mm to 20 mm i.d. on a ZIC®-HILIC column used for separating ascorbic acid from white wine and using a large volume injection (10 % of the total column volume). The analytical separation is carried out at 1.0 mL/min with an injection volume of 250 µL. Adjusting for injection volume effects, the linear scaling to a 20 mm i.d. column of same length, corresponds to a flow rate of 20 mL/min. As can be seen in the figure, the same result was obtained in both column dimensions. This example shows that it is possible to scale up on ZIC®-HILIC columns without losing resolution, which is very important for a fast scale up process without any method redevelopment.

Scaling from 4.6 to 20 mm i.d. ZIC®-HILIC column for a separation of ascorbic acid from white wine

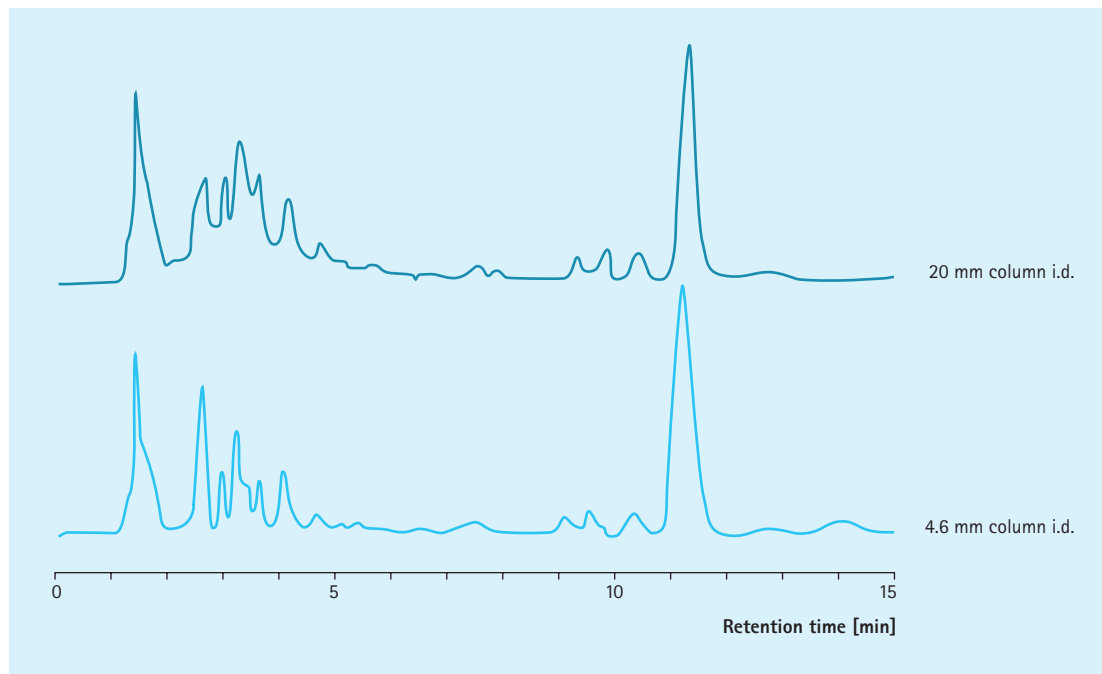

Scaling the separation

Practical examples of scale purification

LiChroprep® application for Prostaglandins

The second example is a LiChroprep® application for Prostaglandins where an analytical scouting separation was performed at 1.5 mL/min on a 250–4 mm LiChrosorb® Si 60 with 10 µm particles.

The chromatogram (A) shows a sufficiently resolved main peak (at 7.5 minutes), hence the separation was scaled to a large i.d. column. In figure (B) the same sample (but with much higher loading) is purified at 2.0 L/min on a 600–200 mm LiChroprep® Si 60 with 25–40 µm particles. The example illustrate a flow rate scaling with consideration to the inner diameter of the column, but where the total chromatogram time is longer because the column length has been adjusted to accommodate a larger loading. In the chromatogram (B), there are also four different fractionation zones identified from which the prostaglandine purity is determined.

A. LiChrosorb® Si 60, 10 µm

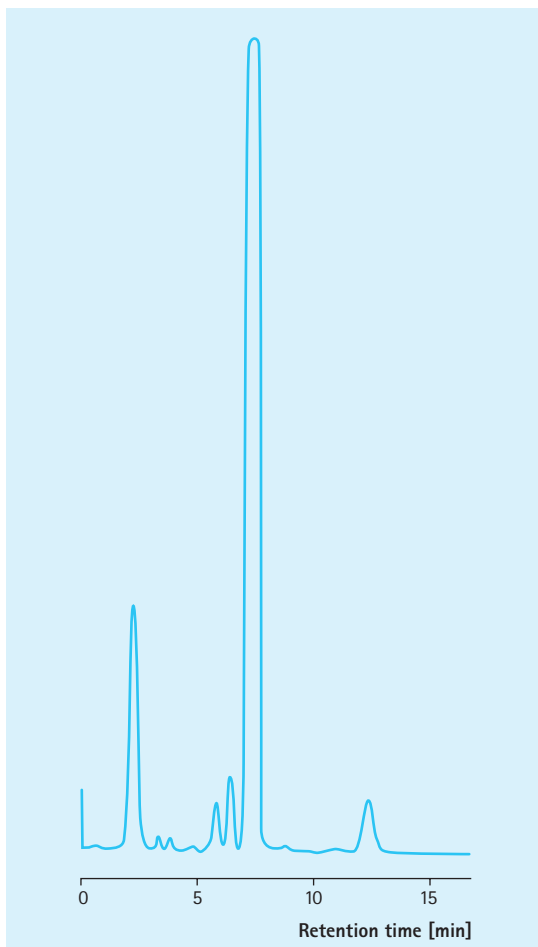

(A) Analytical scouting separation of a prostaglandin sample performed at 1.5 mL/min on a 250–4 mm LiChrosorb® Si 60 with 10 µm particles.

B. LiChroprep® Si 60, 25–40 µm

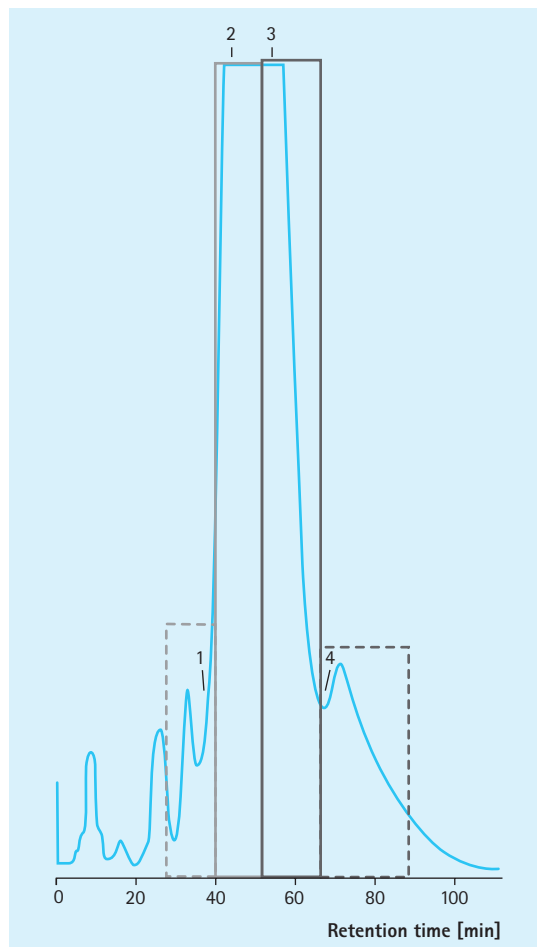

(B) Up-scaled separation of the same prostaglandin sample (but with higher loading) performed at 2.0 L/min on a 600–200 mm LiChroprep® Si 60 with 25–40 µm particles.

Alternative scaling – from TLC to preparative HPLC

During drug discovery and development, a vast amount of compounds have to be purified from extracts or combinatorial libraries for activity testing. Because of the high throughput synthesis and high throughput screening, traditional purification techniques such as preparative TLC or crystallization (low throughput), may create a bottleneck in the laboratory, but are a very useful and quick approach. This topic is not discussed in detail here, but more information can be found at the website www.merckmillipore.com/chromatography. There you can also find information about the new exciting possibilities in combining TLC purification with mass spectrometric detection, e.g. TLC/HPTLC-DART-MS, TLC/HPTLC-MALDI-MS and TLC/HPTLC-ESI-MS, which potentially can be of great interest to the synthesis chemist. TLC has also been found to be a very quick and easy scouting method to predict optimum conditions for preparative HPLC runs.

Method transfer from TLC to Flash chromatography

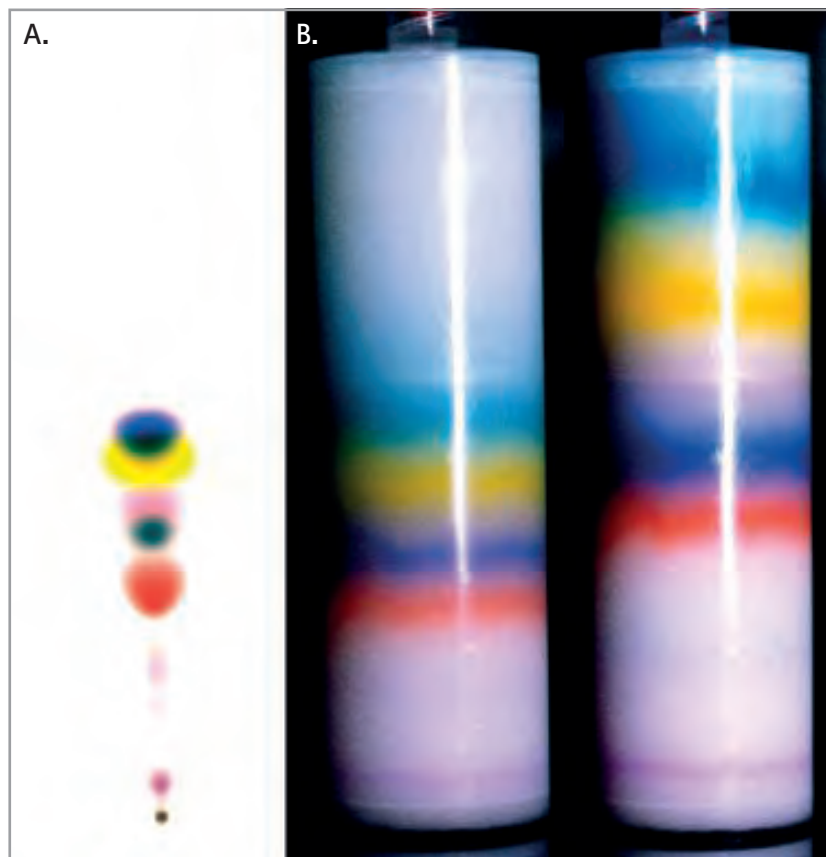

(A) Method development using
TLC Silica gel 60

(B) Method transfer from TLC to Flash chromatography under same
chromatographic conditions



06

Ion Chromatography



www.merckmillipore.com/ion-chromatography

See the invisible. Whether in water, food, other beverages, or environmental samples, Merck Millipore's innovative ion chromatography solutions help you quickly spot impurities. Our products not only offer superior detectability, but also simpler analysis to facilitate your work, and ensure the safety of your products. No wonder they are trusted by commercial, environmental and academic organizations worldwide.

Ion Chromatography

page 434

SeQuant® SAMS & CARS suppressor system
High sensitivity and low background in anion chromatography

page 435

Ion Chromatography Introduction

Ion chromatography is an important method used to verify the safety of water and food supply around the world. This technique supports numerous other applications including environmental monitoring, ensuring the secure operation of nuclear power plants, and quality control in electronic and pharmaceutical industries.

Suppressed ion chromatography has become the dominating approach in anion chromatography. The continuous chemical suppression of the eluent reduces the background while simultaneously increasing the signal for the analyte anions. As a result, it enables high sensitivity assays and trace analyses.

For enhanced detectability and simpler analysis of anions, Merck Millipore has developed the SeQuant® SAMS membrane suppressor, which is operated using the SeQuant® CARS continuous regeneration system. The robustness and high capacity of this suppression system makes it suitable for routine analysis use as well as for high ion-strength eluents and gradient separations. To ensure smooth operation of your system for many years, a range of affordable refill and replacement products and installation accessories are also available.

SeQuant® SAMS & CARS suppressor system

High sensitivity and low background in anion chromatography

The SeQuant® CARS system is designed for optimized eluent suppression with the SAMS suppressor, regardless of flow rate and composition of the mobile phase. This warrants that the lowest possible background conductivity level and highest possible analyte sensitivity is always reached, no matter what the application is.

The CARS system with SAMS suppressor can successfully be used for standard routine operation, but due to its very high capacity and the continuous rapid regeneration of the suppressor, the system is also suitable for high ion-strength eluents and gradient elution.

SeQuant® SAMS is a chemically regenerated membrane suppressor for anion chromatography. Its operation is based on selective exchange of protons (H^+) from an external regeneration channel for cations (e.g., Na^+) from the eluent. SAMS is manufactured according to state-of-the-art in chromatographic reactor technology, and features both high transport capability and low band-broadening.



SAMS anion membrane suppressor



CARS regeneration cartridge

SeQuant® SAMS & CARS suppressor system benefits

- Low and stable background levels and high sensitivity in routine analysis
- Can be integrated with any ion chromatography system
- Suitable also for high ion-strength eluents and gradient applications

► Mobile phases and reagents for HPLC and TLC

page 17

Ordering information

Product	Ordering No.	Contents of one package
CARS Continuous Anion Regeneration System [complete system]	1.50611.0001	1 CARS pump 1 CARS cartridge – small 1 x 100 mL ULB-P regeneration solution 1 suppressor installation kit
SAMS standard Membrane suppressor for analysis in anion ion chromatography	1.50609.0001	1 suppressor 100 cm membrane, 10-32 fittings 1 fitting kit with 10-32 UNF fittings for 1/16" tubing 1 syringe
SAMS gradient Membrane suppressor for gradient analysis in anion ion chromatography	1.50610.0001	1 suppressor 200 cm membrane, 10-32 fittings 1 fitting kit with 10-32 UNF fittings for 1/16" tubing 1 syringe
CARS cartridge – small Small replacement regeneration cartridge	1.50613.0001	1 cartridge 0.5 L, capacity 0.9 eq
CARS cartridge – large Large replacement regeneration cartridge	1.50614.0001	1 cartridge 0.75 L, capacity 1.3 eq
ULB-P regeneration solution	1.50616.0100	100 mL
Pressure relief valve	1.50618.0001	1 pressure relief valve 100 psi
CARS suppressor installation kit	1.50619.0001	5 m regeneration channel tubing 6 luer fittings for regeneration channel

To get started you need the CARS System [1.50611.0001] and SAMS Suppressor [e.g., 1.50609.0001]. In addition, a pressure relief valve [1.50618.0001] is recommended.

Application example

The robust and flexible design makes it easy to integrate CARS and SAMS with any ion chromatography system. An example of results obtained with CARS and SAMS integrated with an ion chromatography system having suitable anion separation column is shown below.

Schematic diagram of the installation of CARS and SAMS in an ion chromatography system

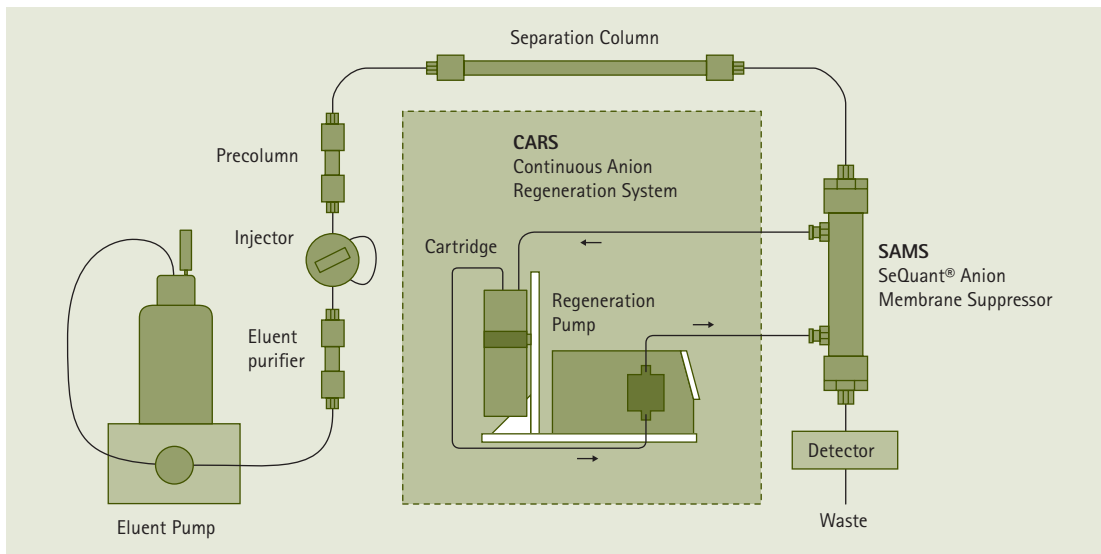

Chromatogram for isocratic separation of a mixture of inorganic anions using CARS with SAMS for suppression of the background conductivity

Eluent	1.7 mM NaHCO ₃ / 1.8 mM Na ₂ CO ₃
Flow rate	1 mL/min
Sample	20 µL of 1-30 ppm of each anion in water

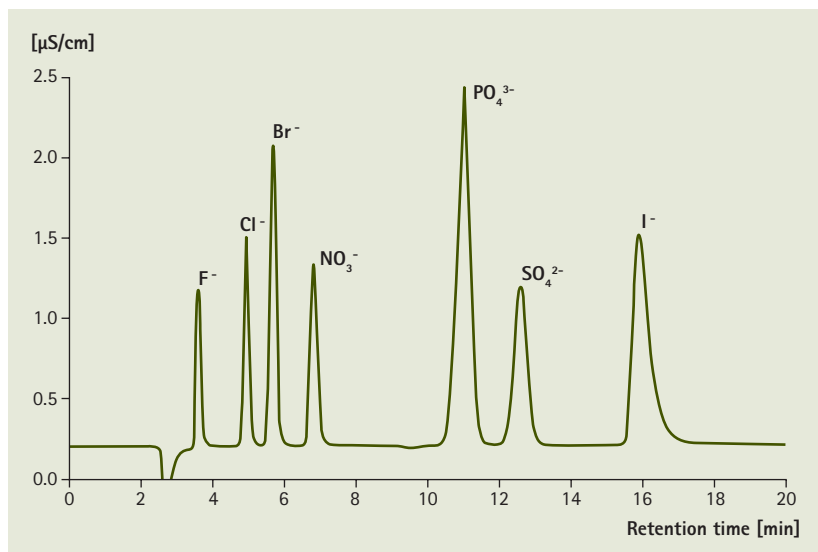

Characterization

In the SeQuant® CARS system, the eluent is suppressed in the SAMS suppressor using protons supplied by the CARS regeneration cartridge and carried there by the ULB-P regeneration solution. The CARS pump ensures stable operation of the entire system by continuously circulating the ULB-P solution.

CARS system parts

Component	Included in	Description	Task	Typical replacement interval
SAMS	1.50609.0001 1.50610.0001	Robust membrane suppressor	Exchange eluent cations (e.g., Na ⁺) to protons (H ⁺).	12-24 months Depending on amounts of samples and their purity
CARS pump	1.50611.0001	Circulation pump	Ensure continuous and stable delivery of the ULB-P throughout the system	Not applicable Only normal instrument service required
CARS regeneration cartridge	1.50611.0001 1.50613.0001 1.50614.0001	High-capacity source of protons	Supply protons (H ⁺) to the SAMS suppressor	6-12 months Depending on hours of use, eluent strength and flow rate
ULB-P regeneration solution	1.50611.0001 1.50616.0100	Ultra-pure liquid ion exchanger	Carry protons (H ⁺) from the cartridge to the suppressor, and eluent cations (e.g., Na ⁺) back to the cartridge	6-12 months Typically replaced when a new cartridge is installed or if the system becomes contaminated
Pressure relief valve	1.50618.0001	Safety valve for suppressor	Insure SAMS against high detector pressure	Not applicable
CARS suppressor installation kit	1.50611.0001 1.50619.0001	Tubing kit	Tubing for the ULB-P circulation	Not applicable

Typical suppression performance and cartridge lifetime of CARS with SAMS in an ion chromatographic system. The example is based on the standard type SAMS and the standard type CARS cartridge (0.5 L, 0.9 eq).

Eluent type	NaOH mM	Na ₂ CO ₃ mM	NaHCO ₃ mM	Flow rate mL min ⁻¹	Conductivity μS cm ⁻¹	Expect. cartridge lifetime full 8-hour working days
10	–	–	–	1.0	<3	170
–	–	2.4	3.0	1.0	15-20	210
–	–	2.4	3.0	2.0	15-20	105

Schematic illustration of the ion exchange processes within SAMS and CARS

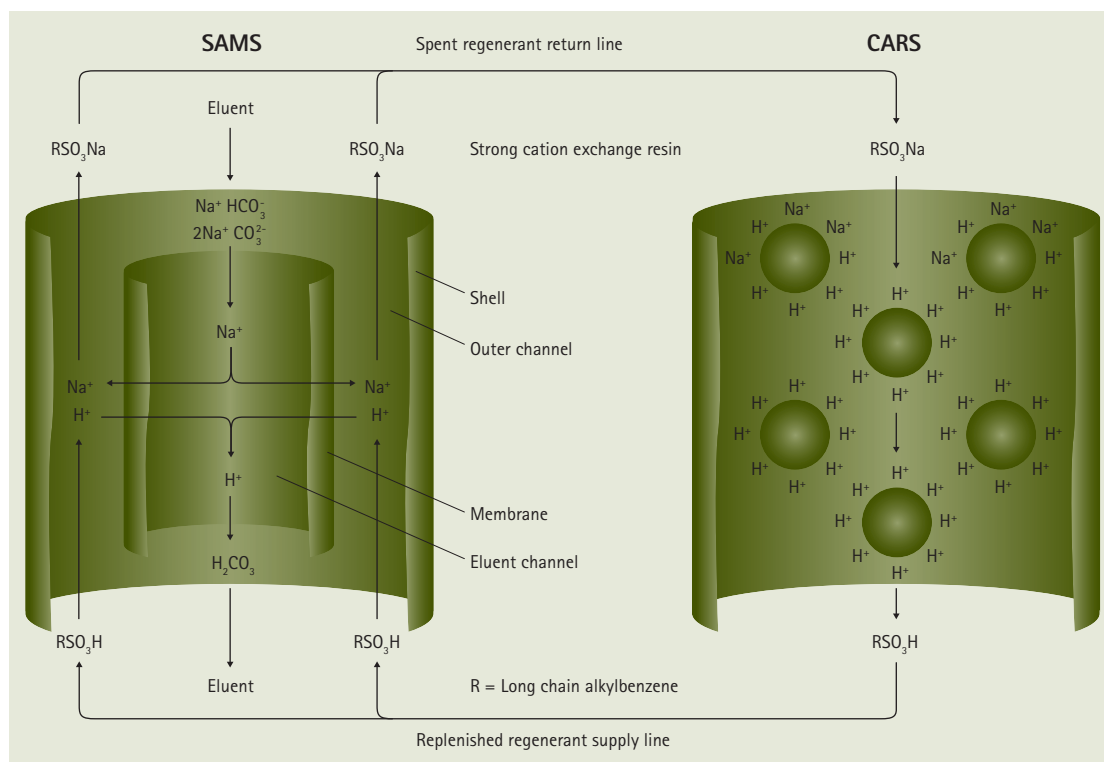

In the SAMS suppressor (left), eluent cations (Na^+) are replaced by protons (H^+) in an ion exchange process over the suppressor membrane. The protons (H^+) are carried to the outer channel of the SAMS suppressor by the ULB-P regeneration solution (bottom, RSO_3H). After the ion exchange process, the ULB-P solution (top, RSO_3Na) returns to the CARS regeneration cartridge (right) and deposits the former eluent cations (Na^+), while acquiring new protons (H^+) from the ion exchange resin. The process can be continuously repeated until the CARS regeneration cartridge is depleted of protons.

For the most up-to-date information, products and applications, please visit www.merckmillipore.com/ion-chromatography and ask for your free copy of the booklet **A Practical Guide to Ion Chromatography**.



07

Gas Chromatography



www.merckmillipore.com/gas-chromatography

Enjoy the fruits of nature like never before. With Merck Millipore's gas chromatography expertise, you can easily verify the safety and quality of your agricultural products. Our extensive range of high-purity solvents, standards and sorbents enable rapid, reliable analysis of numerous pesticides and trace residues. So you can protect your customers, and your profits.

07

Contents

Gas Chromatography

page 443

High purity solvents for gas chromatography

page 444

SupraSolv®
Solvents for gas chromatography

page 445

SupraSolv®
Solvents for headspace gas chromatography

page 448

UniSolv®
Solvents for organic trace analysis

page 452

Sorbents for packed columns

page 456

Derivatization reagents

page 457

Reference substances

page 459

Gas Chromatography

Introduction

Despite numerous developments in analytical chemistry, gas chromatography remains one of the most frequently used analytical techniques. Its application spans an extensive range of fields, including medicine, biology, environmental sciences as well as industrial production. No other analytical method can combine resolving power with analysis speed and sensitivity.

Provided that the sample has sufficient volatility and thermal stability in the selected temperature region, gas chromatography is the method of choice. Besides qualitative and quantitative information contained in the chromatogram, gas chromatography (GC) can be easily combined with spectrometric techniques for structure confirmation or selective detection, such as in GC-MS (mass spectrometry).

The performance of columns and chromatographic equipment has steadily advanced. A major breakthrough was the invention of capillary columns by Golay in 1958. The introduction of flexible fused silica columns by Dandeneau and Zerenner in 1979 greatly influenced the acceptance of capillary columns. Compared to packed columns, capillary columns provide superior resolution in a shorter analysis time. Therefore, capillary columns have become the preferred tool for analytical work.

A wide range of universal and selective detectors with well adapted solvents (high purity solvents) are available, many of them eminently suited for residue and trace analysis. Autosamplers, that can run unattended, provide very good precision in sample introduction. Quantitative GC-results can be very accurate.

For all the reasons summed up above, it is clear that GC is the method of choice, provided that the sample has sufficient volatility and thermal stability in the selected temperature region.

The chromatography products from Merck Millipore are not intended for use as medical devices for in-vitro diagnostic testing of human specimens within the meaning of European Directive 98/79/EC. They are for research purposes only, for investigating in-vitro samples without any medical objective.

High purity solvents for gas chromatography

Tailor-made solvents for gas chromatography

GC-Analysis comprises sample preparation, such as extraction and concentration of the extracts before injection. Solvents are necessary with the highest possible degree of purity. SupraSolv® and UniSolv® are the GC solvents of high batch consistency for all trace and environmental analyses.

They provide the analyst with the security and reliability so necessary for today's applications, especially when monitoring and determining environmentally relevant substances in soil and water samples, e.g. polycyclic aromatic hydrocarbons (PAH), polychlorinated biphenyls (PCB), polychlorinated dibenzodioxins (PCDD), pesticides, but also highly volatile chlorinated hydrocarbons (HVHC) present in ppb trace amounts only.

Whilst the demands placed on the selectivity and sensitivity of the detection procedures used for environmental pollutants are constantly increasing, the results obtained may be adversely affected by the tiniest traces of impurities in the solvents used. The specifications of the solvents have been especially adapted to the particular area of application.

- SupraSolv® for gas chromatography
- UniSolv® for organic trace analysis

Solvents for gas chromatography

Specifications at a glance	GC-ECD Dichloromethane to 1,2,4-Trichlorobenzene (Tetrachloromethane standard)	GC-ECD pesticide analysis 1,2,4-Trichlorobenzene to Decachlorobiphenyle (Lindane standard)	GC-FID n-Undecane to n-Tetracontane (n-Tetradecane standard)	GC-MS n-Undecane to n-Tetracontane; scan range 30-600 amu (n-Tetradecane standard)
SupraSolv® solvents for gas chromatography ECD and FID	–	max. 3 pg/mL	max. 3 ng/mL	–
SupraSolv® solvents for gas chromatography MS	–	–	–	max. 3 ng/mL
UniSolv® solvents for organic trace analysis	max. 1 ng/mL	max. 2 pg/mL	max. 2 ng/mL	max. 2 ng/mL

SupraSolv® and UniSolv® benefits

- The most comprehensive application area due to the largest retention time range
- Analytical reliability due to the highest possible purity and a minimal signal-to-noise ratio
- Time and cost savings due to the best possible batch consistency, thus avoiding analysis repetition

SupraSolv[®] solvents for gas chromatography

With gas chromatography, only solvents with the highest levels of purity are suitable for sample preparation tasks such as the extraction and concentration of the extracts before injection. SupraSolv[®] solvents are developed specially for this highly sophisticated application area.

Our comprehensive portfolio of GC solvents offers the right product for your specific application and detection method. SupraSolv[®] ECD and FID is specially developed and tested for ECD (Electron Capture Detector) and FID (Flame Ionization Detector). Typical applications include the determination of polychlorinated biphenyls (PCB) in water and soil or pesticides in fruits and vegetables. SupraSolv[®] MS is dedicated for use in gas chromatography coupled with mass spectrometric detection. This method is of increasing importance and used e.g. for the analysis of dioxins and furans (PCDD/PCDF) in food and water samples or for the determination of PAH (polycyclic aromatic hydrocarbons) in food. Both SupraSolv[®] qualities are carefully tested for the specific detectors and offer a clear baseline and minimal signal-to-noise ratio within a specified retention time range. Therefore SupraSolv[®] solvents help you achieve consistently accurate, reliable and reproducible results.

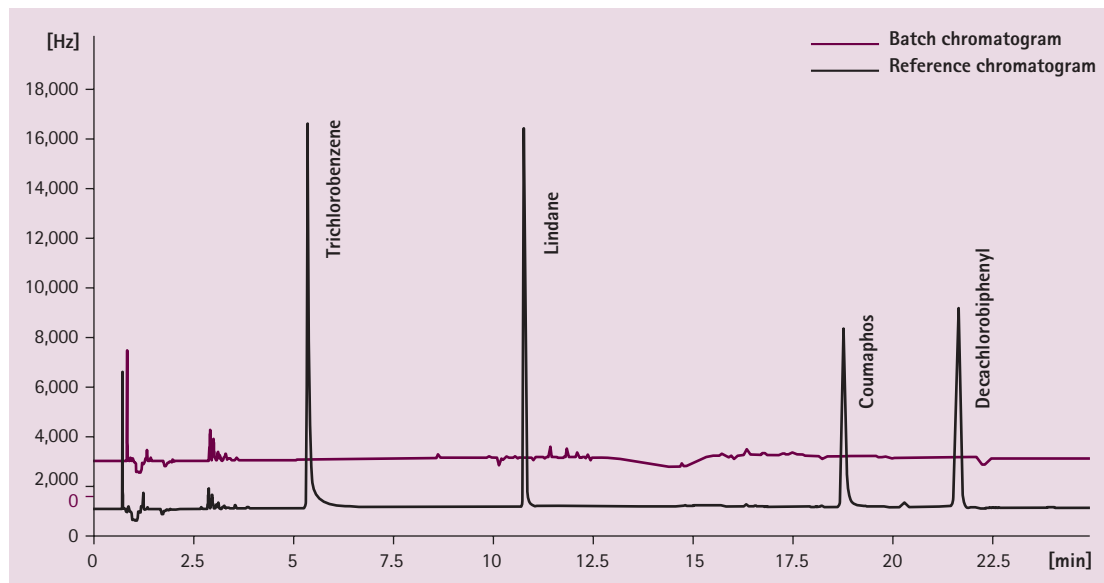



GC-ECD, batch and reference chromatogram (Lindane = 3 pg/mL, n-Hexane SupraSolv[®] EDC and FID [Cat. No. 104371])

► Solvent withdrawal systems

page 29

SupraSolv® solvents for gas chromatography

Ordering information – SupraSolv® solvents for gas chromatography ECD and FID A-L

Product	Ordering No.	Content / Packaging	Purity (GC) min. [%]	Evap. residue max. [mg/L]	Water max. [%]	Color max. [Hazen]
Acetone	1.00012.1000	1 L GL	99.8	3.0	0.05	10
	1.00012.2500	2.5 L GL				
	1.00012.4000	4 L GL				
	1.00012.9030	30 L ST				
Acetonitrile	1.00017.1000	1 L GL	99.8	3.0	0.05	10
	1.00017.2500	2.5 L GL				
	1.00017.4000	4 L GL				
tert-Butyl methyl ether	1.01995.1000	1 L GL	99.8	3.0	0.02	10
	1.01995.2500	2.5 L GL				
Chloroform, stabilized	1.02432.1000	1 L GL	99.8	5.0	0.01	10
	1.02432.2500	2.5 L GL				
Cyclohexane	1.02817.1000	1 L GL	99.8	3.0	0.01	10
	1.02817.2500	2.5 L GL				
	1.02817.4000	4 L GL				
	1.02817.9010	10 L ST				
Dichloromethane, stabilized	1.06054.1000	1 L GL	99.8	5.0	0.01	10
	1.06054.2500	2.5 L GL				
	1.06054.4000	4 L GL				
	1.06054.9010	10 L ST				
Diethyl ether, stabilized	1.00931.1000	1 L GL	98.0	3.0	0.05	10
	1.00931.2500	2.5 L GL				
N,N-Dimethylformamide	1.10983.1000	1 L GL	99.8	3.0	0.05	10
	1.10983.2500	2.5 L GL				
 Ethanol	1.02371.1000	1 L GL	99.8	3.0	0.05	10
	1.02371.2500	2.5 L GL				
	1.02371.4000	4 L GL				
Ethyl acetate	1.10972.1000	1 L GL	99.8	3.0	0.02	10
	1.10972.2500	2.5 L GL				
	1.10972.4000	4 L GL				
	1.10972.9010	10 L ST				
 n-Heptane	1.04360.1000	1 L GL	99.8	3.0	0.02	10
	1.04360.2500	2.5 L GL				
n-Hexane	1.04371.1000	1 L GL	98.0*	3.0	0.01	10
	1.04371.2500	2.5 L GL				
	1.04371.4000	4 L GL				
	1.04371.9010	10 L ST				
	1.04371.9030	30 L ST				
Isohexane	1.04340.2500	2.5 L GL	99.8	3.0	0.01	10
Isooctane	1.15440.1000	1 L GL	99.8	3.0	0.01	10
	1.15440.2500	2.5 L GL				

GL = glass bottle | ST = stainless steel barrel | * = sum of hexane isomers + methyl cyclopentane (GC) ≥99.8 % | GC-ECD (retention range 1,2,4-Trichlorobenzene to Decachlorobiphenyle individual signals (Lindane standard)) ≤3 pg/mL | GC-FID (retention range n-Undecane to n-Tetracontane individual signals (n-Tetradecane standard)) ≤3 ng/mL

Ordering information – SupraSolv® solvents for gas chromatography ECD and FID M-Z

Product	Ordering No.	Content / Packaging	Purity (GC) min. [%]	Evap. residue max. [mg/L]	Water max. [%]	Color max. [Hazen]
Methanol	1.06011.1000	1 L GL	99.8	3.0	0.1	10
	1.06011.2500	2.5 L GL				
	1.06011.4000	4 L GL				
n-Pentane	1.00882.1000	1 L GL	99.8	3.0	0.02	10
	1.00882.2500	2.5 L GL				
	1.00882.4000	4 L GL				
Petroleum benzine (40 – 60°C)	1.01772.1000	1 L GL	–	3.0	0.01	10
	1.01772.2500	2.5 L GL				
	1.01772.4000	4 L GL				
	1.01772.9010	10 L ST				
2-Propanol	1.00998.1000	1 L GL	99.8	3.0	0.1	10
	1.00998.2500	2.5 L GL				
Toluene	1.08389.1000	1 L GL	99.8	3.0	0.03	10
	1.08389.2500	2.5 L GL				
	1.08389.4000	4 L GL				

GL = glass bottle | ST = stainless steel barrel | GC-ECD (retention range 1,2,4-Trichlorobenzene to Decachlorobiphenyle individual signals (Lindane standard)) ≤3 pg/mL | GC-FID (retention range n-Undecane to n-Tetracontane individual signals (n-Tetradecane standard)) ≤3 ng/mL



Please have a look at the solvent withdrawal systems on page 29 for more specific information.

Ordering information – SupraSolv® solvents for gas chromatography MS

Product	Ordering No.	Content / Packaging	Purity (GC) min. [%]	Evap. residue max. [mg/L]	Water max. [%]	Color max. [Hazen]
Acetone	1.00658.1000	1 L GL	99.8	3.0	0.05	10
	1.00658.2500	2.5 L GL				
Acetonitrile	1.00665.1000	1 L GL	99.8	3.0	0.05	10
	1.00665.2500	2.5 L GL				
Cyclohexane	1.00667.1000	1 L GL	99.8	3.0	0.01	10
	1.00667.2500	2.5 L GL				
Dichloromethane, stabilized	1.00668.1000	1 L GL	99.8	5.0	0.01	10
	1.00668.2500	2.5 L GL				
Ethyl acetate	1.00789.1000	1 L GL	99.8	3.0	0.02	10
	1.00789.2500	2.5 L GL				
n-Hexane	1.00795.1000	1 L GL	98.0*	3.0	0.01	10
	1.00795.2500	2.5 L GL				
Methanol	1.00837.1000	1 L GL	99.8	3.0	0.1	01
	1.00837.2500	2.5 L GL				
Toluene	1.00849.1000	1 L GL	99.8	3.0	0.03	10
	1.00849.2500	2.5 L GL				

GL = glass bottle | * = sum of hexane isomers + methyl cyclopentane (GC) ≥99.8 % | GC-MS (retention range n-Undecane to n-Tetracontane; scanning area 30–600 amu individual signals (n-Tetradecane standard)) ≤3 ng/mL

SupraSolv[®] solvents for headspace gas chromatography



Headspace gas chromatography is a precise, well-accepted method for the analysis of residual solvents in drug substances and products. It is recommended as the preferred method of analysis for this application by the European Pharmacopeia (Chapter 2.4.24) and the United States Pharmacopeia (Chapter 467).

The ICH (International Conference on Harmonization of Technical Requirements for Registration of Pharmaceuticals for Human Use) Guideline Q3C »Impurities: Guideline for Residual Solvents« divides all residual solvents into three classes according to their harmfulness for human health, and defines permissible maximum concentrations in actives, excipients and drug products. Both the European and the United States Pharmacopeia refer to this guideline. Accurate analysis with headspace gas chromatography demands the use of very pure solvents with extremely low concentrations of the defined residual solvents.

By specifying for SupraSolv[®] headspace the concentrations of all residual solvents of the three defined classes in the ICH guideline, Merck Millipore offers a precise purity window for this application – for unique, application-orientated quality. Since we also perform a headspace application test on each batch, every delivery gives you the reliability, accuracy and analytical safety you need.

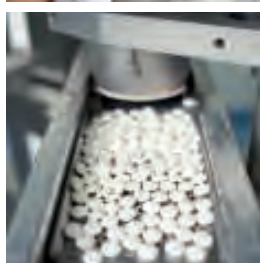

Extract of specification

Every residual solvent of class 1 according to ICH	≤1 µg/g
Every residual solvent of class 2 according to ICH	≤10 µg/g
Every residual solvent of class 3 according to ICH	≤50 µg/g

ICH = International Conference on Harmonization of Technical Requirements for Registration of Pharmaceuticals for Human Use

Ordering information – SupraSolv[®] Headspace for the analysis of residual solvents according to ICH, Ph Eur and USP

Product	Ordering No.	Content / Packaging	Purity (GC) min. [%]	Evap. residue max. [mg/L]	Water max. [%]	Color max. [Hazen]
NEW N,N-Dimethylacetamide	1.00399.0500	500 mL GL	99.8	3.0	0.05	10
	1.00399.1000	1 L GL				
N,N-Dimethylformamide	1.00202.0500	500 mL GL	99.8	3.0	0.05	10
	1.00202.0501	500 mL SB				
	1.00202.1000	1 L GL				
	1.00202.2500	2.5 L GL				
Dimethyl sulfoxide	1.01900.0500	500 mL GL	99.8	3.0	0.05	10
	1.01900.0501	500 mL SB				
	1.01900.1000	1 L GL				
	1.01900.2500	2.5 L GL				
NEW 1-Methyl-2-pyrrolidone	1.02497.0500	500 mL GL	99.8	3.0	0.05	10
	1.02497.1000	1 L GL				
	1.02497.2500	2.5 L GL				
NEW Water	1.00577.1000	1 L GL	-	5.0	-	-
	1.00577.2500	2.5 L GL				

GL = glass bottle | SB = Septum seal bottle | Every residual solvent of class 1 acc. ICH ≤1 µg/g | Every residual solvent of class 2 acc. ICH ≤10 µg/g | Every residual solvent of class 3 acc. ICH ≤50 µg/g

SupraSolv[®] headspace solvents are specially designed for the analysis of residual solvents according to Ph Eur and USP. We have developed them in close cooperation with an experienced headspace laboratory, and manufacture them using special production processes. As a result, these high purity products ensure reliable, accurate analytical results.

Application: Quantification of residual solvents in an API

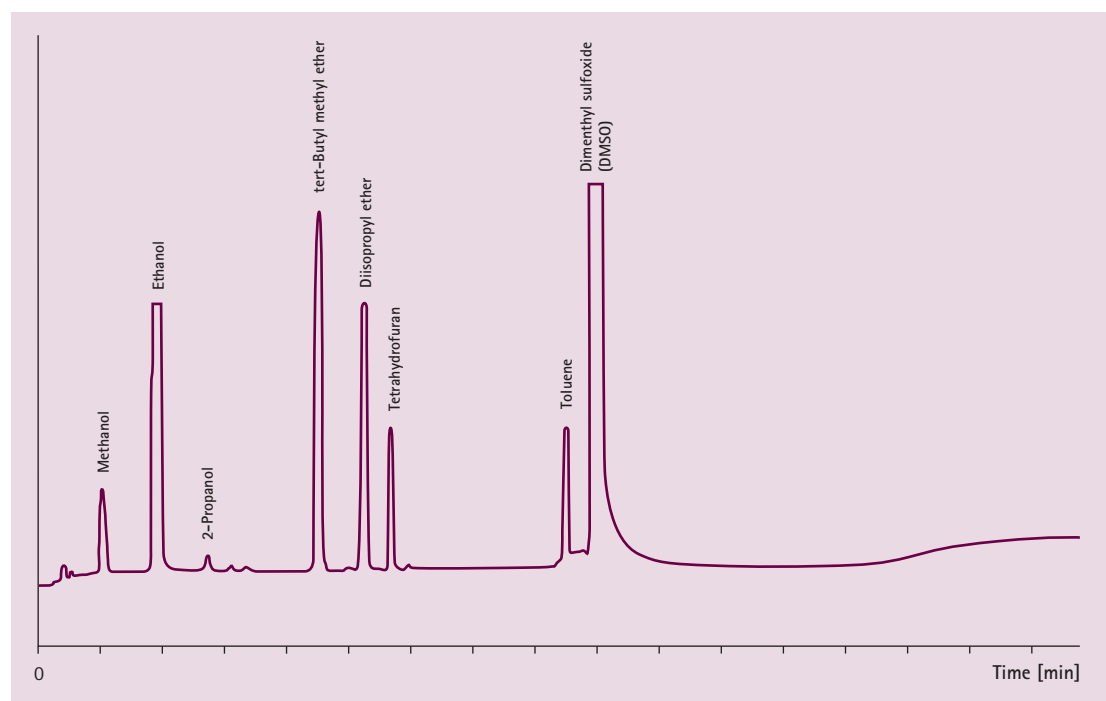

Quantification of residual solvents in an API using Dimethyl sulfoxide (DMSO) SupraSolv[®] for headspace gas chromatography (101900).

Chromatographic conditions

Column	fused silica capillary column, DB 1, length 30 m, ID 0.32 mm, film 5 µm
Pressure	0.6 bar / 8 psi (Helium)
Injection	splitless, 150°C
Headspace conditions	
Thermostating temperature	80°C
Transfer and needle temperature	130°C
Thermostating time	30 min
Pressurization	1.0 min
Injection time	0.04 min
Withdrawal time	0.2 min
High pressure	2 bar / 28 psi
Detection	FID, 250°C
Temperature	50°C for 5 min, with 8°C/min up to 240°C, hold 240°C for 5 min
Method	Quantification of residual solvents in an API

Chromatographic data

No.	Compound	Time [min]	Area
1	Methanol	2.0	12361
2	Ethanol	3.8	399048
3	2-Propanol	5.4	2368
4	tert-Butyl methyl ether	9.0	34637
5	Diisopropyl ether	10.5	43000
6	Tetrahydrofuran	11.4	14083
7	Toluene	11.5	11502

SupraSolv® solvents for headspace gas chromatography

Now even better protected – by the SeccoSept® septum seal cap

The handling of headspace solvents is very critical, as there is a high risk of cross-contamination with highly volatile organic compounds in the air. The innovative SeccoSept® septum closure has been developed to optimally protect high-purity solvents from potential contaminants and ensure safe and simple handling. Beside SeccoSolv® dried solvents, also SupraSolv® headspace solvents are now available in combination with SeccoSept®. With the SeccoSept® septum cap, potential cross-contamination is prevented, as the bottle remains closed. Therefore the solvent can be reliably used until the last drop.

SeccoSept® features a rotating cap that in turn exposes and covers five extra-large circular areas of septum for repeated puncturing. Multiple layers of protection make sure that the solvent is always in flawless condition – before, during and after removal. SeccoSept® offers double tamper evidence: A security ring on the screw closure and a seal on the septa opening eliminate any doubt whether the product has been previously opened. The innovative septum used in SeccoSept® is a special PTFE encapsulated polymer disk featuring extra-large punctation areas as well as outstanding self-sealing properties for rapid re-sealing. The large circular punctation areas represent a major benefit compared to smaller septum areas which are prone to irreversible damage when punctured repeatedly. As a result, the SeccoSept® septum can be punctured multiple times without losing stability or becoming porous or damaged.

SeccoSept® features a special cap that can be rotated over the septum. An opening in the rotating cap in turn uncovers five apertures in the screw closure below exposing extra-large circular septum areas for repeated punctuation. Only the septum circle currently in use is exposed to the environment – after solvent removal, the user simply turns the cap to the sealing position and the fresh puncture site is safely covered again. When needed, the bottle's rotating cap also permits one-handed operation for safe and easy handling during your applications. If you need to withdraw larger quantities of solvent, simply take off the septum cap entirely. Alternatively, you can remove the yellow cap and access all five septum circles simultaneously.



SeccoSept® – Advantages

- Best self-sealing properties due to special PTFE-coated silicon septum
- Best protection from moisture and impurities due to rotatable septum screw cap (only the used septum-circle is exposed to the environment)
- Biggest septum surface due to 5 septum circles
- Allows access to larger volumes as it is useable with and without septum

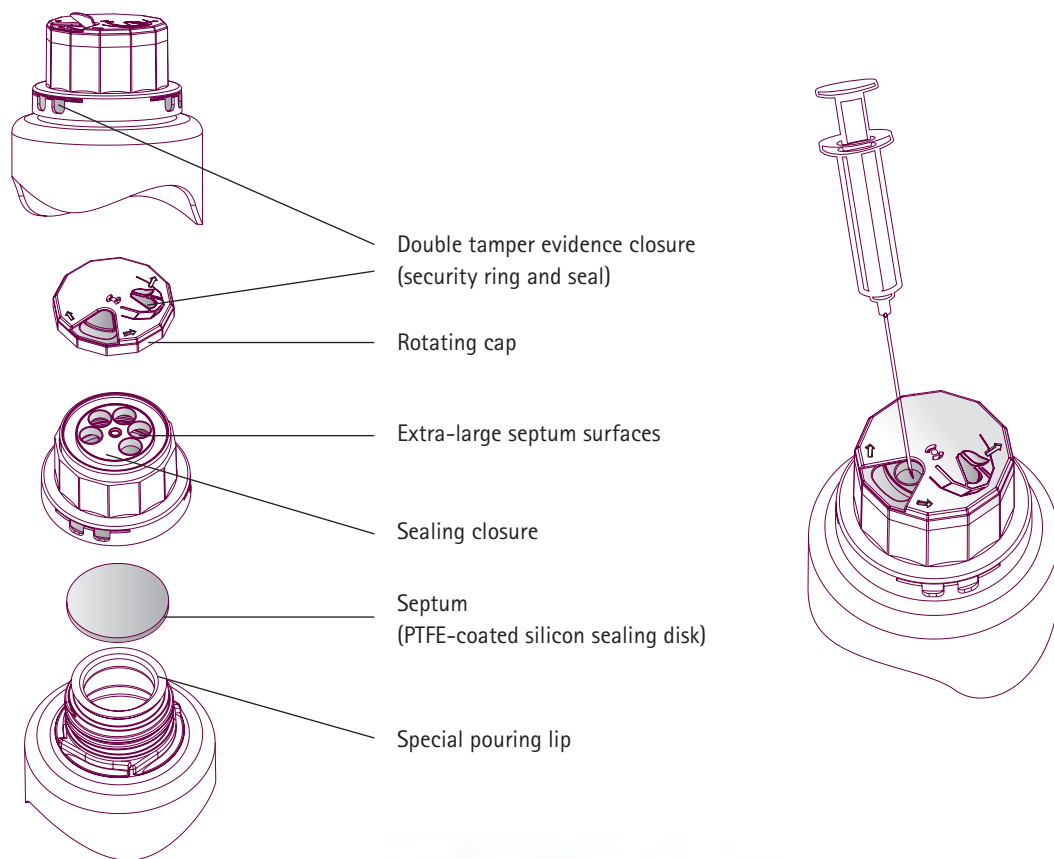

UniSolv[®] solvents for organic trace analysis



UniSolv[®] is the unique solution for all applications. Its specification is even broader and higher than that of SupraSolv[®]: The specified retention time range is larger (so even low-boiling substances can be reliably detected), and the permissible concentration of interference signals within the retention time range is lower too.

We recommend UniSolv[®] for all areas that demand the highest levels of reliability in analytical results – for example, environmental analyses. Intensive research – combined with ongoing product development – not only ensures reliability in standard applications, but also permits easier, more precise analyses in new fields, such as determining the Hydrocarbon-oil index of water and soil samples.



Ordering information – UniSolv[®] solvents for organic trace analysis

Product	Ordering No.	Content / Packaging	Purity (GC) min. [%]	Evap. residue max. [mg/L]	Water max. [%]	Color max. [Hazen]
Dichloromethane	1.06454.1000	1 L GL	99.9	3.0	0.005	10
n-Hexane	1.04369.1000	1 L GL	99.0*	3.0	0.005	10
	1.04369.2500	2.5 L GL				
n-Pentane	1.07288.1000	1 L GL	99.9	3.0	0.01	10
	1.07288.2500	2.5 L GL				
Petroleum benzine (40 – 60°C)	1.16740.1000	1 L GL	–	3.0	0.005	10
	1.16740.2500	2.5 L GL				

GL = glass bottle | * Sum of hexane isomers + methylcyclopentane (GC) $\geq 99.9\%$ | GC-ECD (retention range Dichloromethane to 1,2,4-Trichlorobenzene individual signals (Tetrachloromethane standard)) ≤ 1 ng/mL | GC-ECD (retention range 1,2,4-Trichlorobenzene to Decachlorobiphenyle individual signals (Lindane standard)) ≤ 2 pg/mL | GC-FID (retention range n-Undecane to n-Tetracontane individual signals (n-Tetradecane standard)) ≤ 2 ng/mL | GC-MS (retention range n-Undecane to n-Tetracontane; scanning area 30–600 amu individual signals (n-Tetradecane standard)) ≤ 2 ng/mL

Pesticide residue analysis in apple juice

Juice manufacturers need to check the marketability of their products continuously – for example, by analyzing all the ingredients. Around 500 different pesticides are detectable in juices, and strict national and international regulations govern maximum permissible concentrations.

Classical pesticide residue analysis is still performed with GC-ECD and SupraSolv[®] solvents n-Hexane, Ethyl acetate, Dichloromethane or Acetone. The new, faster method according Anastassiades (QuEChERS) uses GC-MS instead. This method reduces manual effort, improves analytical safety, and extends the range of detectable pesticides. The extraction agent with the best dissolution properties for pesticides is Dichloromethane UniSolv[®] [106454]. Have a look at the figure on the next page.



► Solvent withdrawal systems

page 29

Pesticide residue analysis in apple juice with GC-MS and Dichloromethane UniSolv®

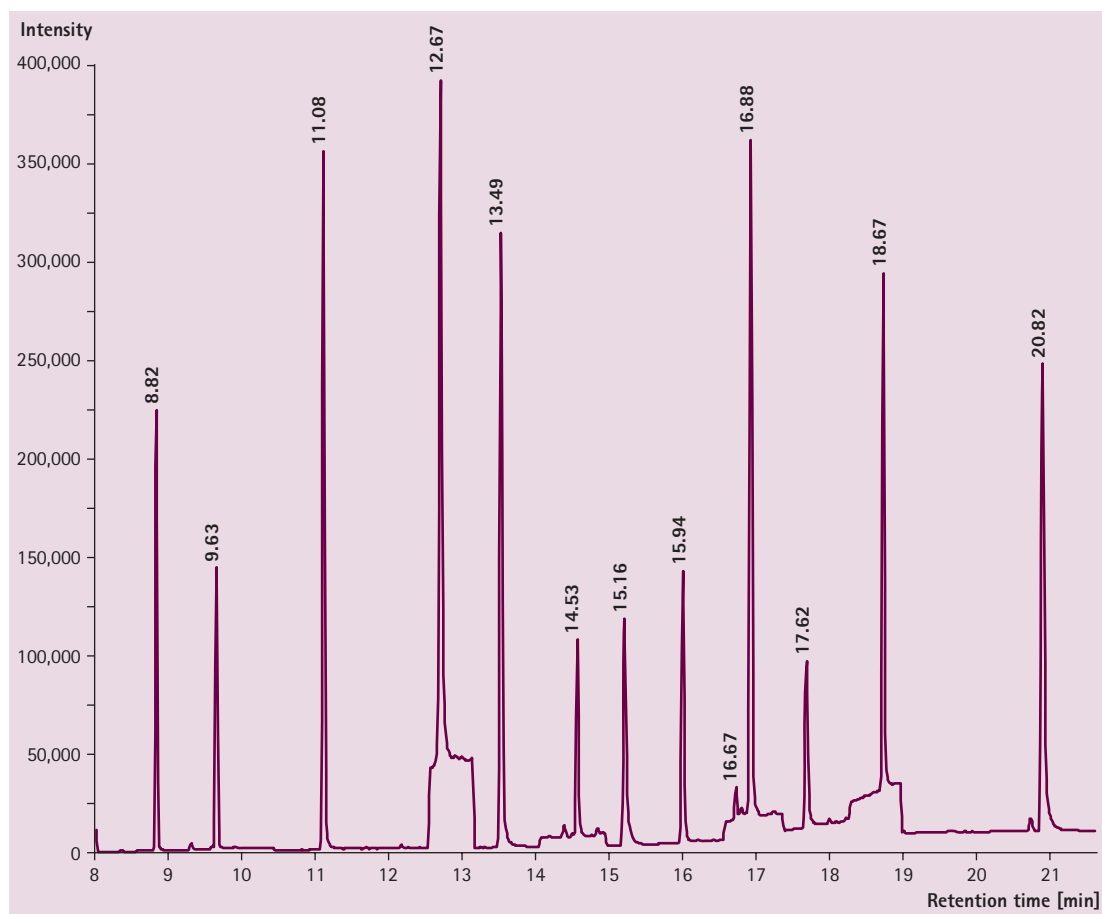

Sample chromatogram (TIC) – Apple juice spiked. Sample preparation via liquid-liquid-extraction with Extrelut® NT 20.

Eluting solvent	Dichloromethane UniSolv® [106454]
Instrumentation	Agilent 7890A
Autosampler	Gerstel MPS
Capillary column	Phenomenex, ZB-MultiResidue; 30 m, 0.25 mm id, 0.25 µm ft
Carrier gas	Helium; constant flow
Injector	CIS 4 (cooled injection system, Gerstel)
Injection volume	2 µL
Detector	MSD 5975C, inert XL MSD triple axis detector

Sample			
RT [min]	Active substance	RT [min]	Active substance
8.82	Trifluralin	15.94	Etoxazol
9.63	Profluralin	16.67	lambda-Cyhalothrin
11.08	Pirimiphos-methyl	16.88	lambda-Cyhalothrin
12.67	Procymidon	17.62	Fenarimol
13.49	p,p'-DDE	18.67	Halfenprox
14.53	Trifloxystrobin	20.82	Azoxystrobin
15.16	Quinoxifen		

UniSolv® solvents for organic trace analysis

UniSolv® – the unique and universal solvent for all your GC applications

No matter which gas chromatography method you use, and regardless of whether you are analyzing soil or water samples: With UniSolv® you only need to use a single quality. UniSolv® is specified for GC-ECD and GC-FID, and also for mass spectroscopy (MS), which is rapidly growing in importance for the structure determination and quantification of sample components.

Gas Chromatography – Electron Capture Detector [GC-ECD]

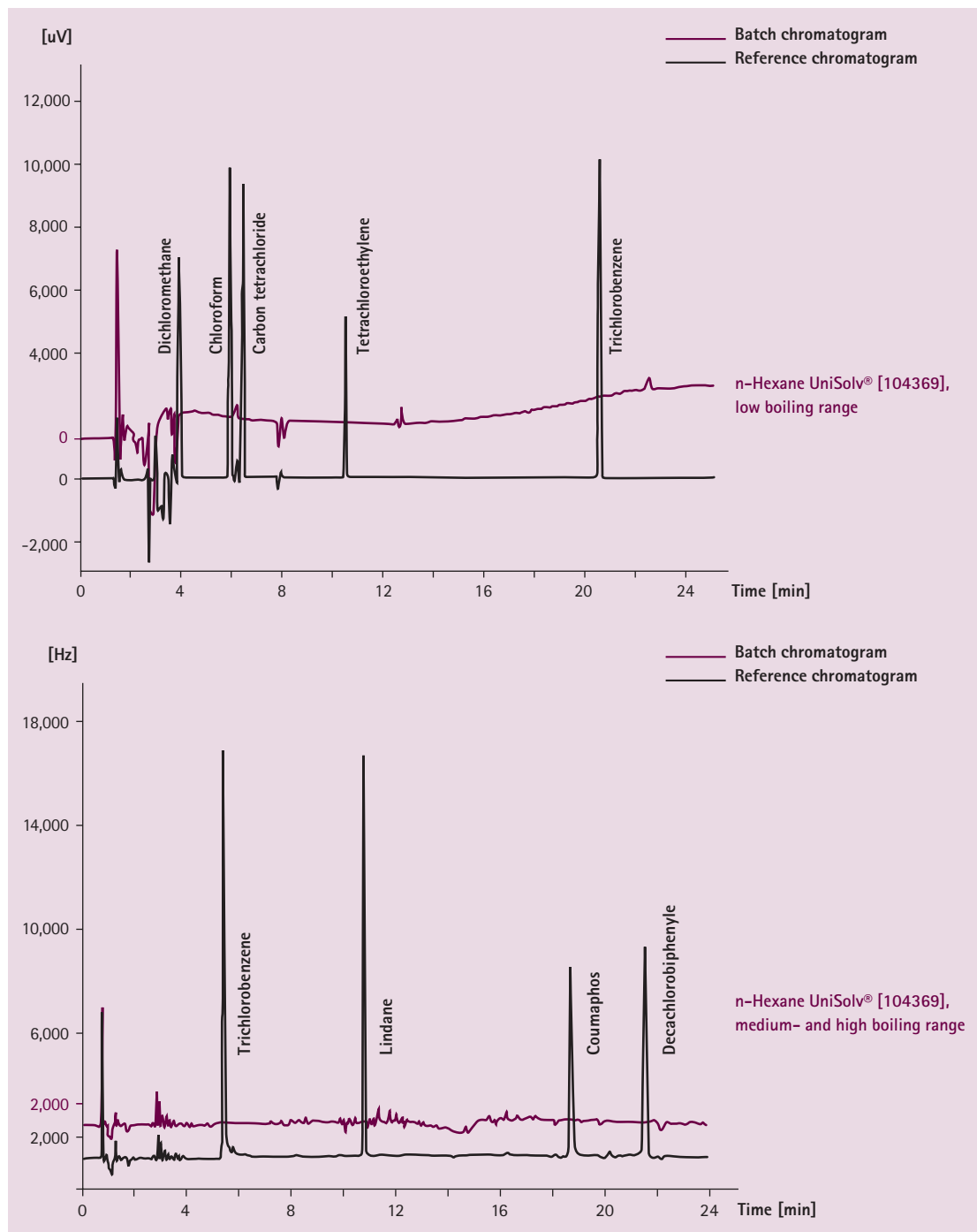

Gas Chromatography – Flame Ionization Detector [GC-FID]

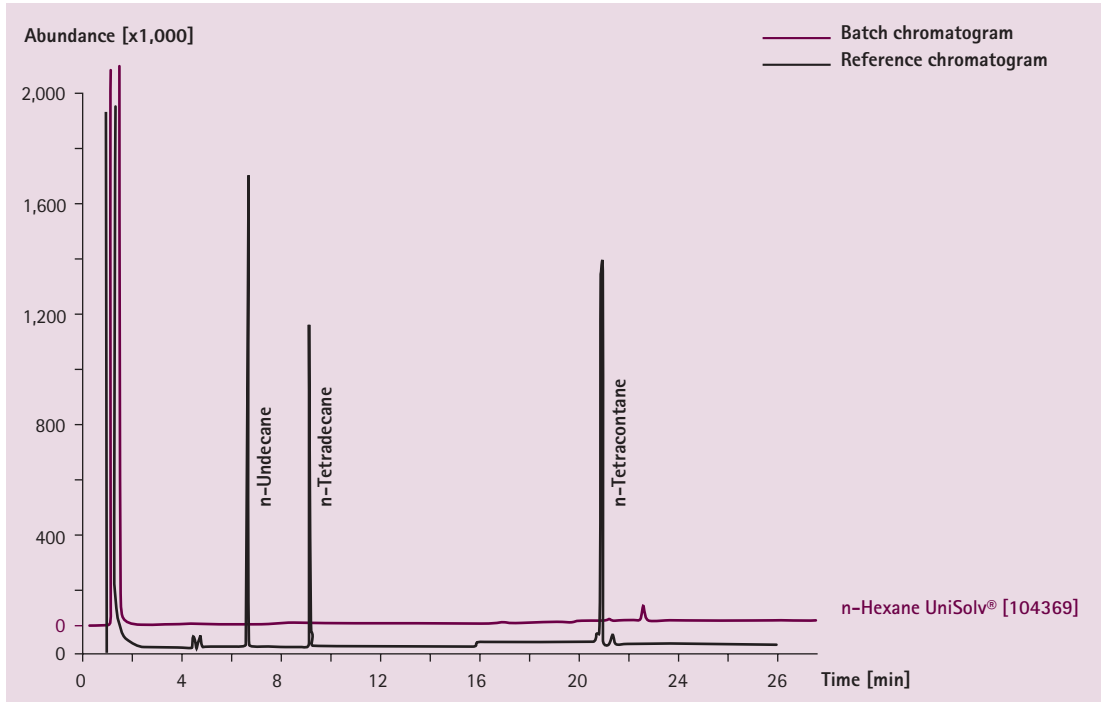

Gas Chromatography – Mass Spectrometry [GC-MS]

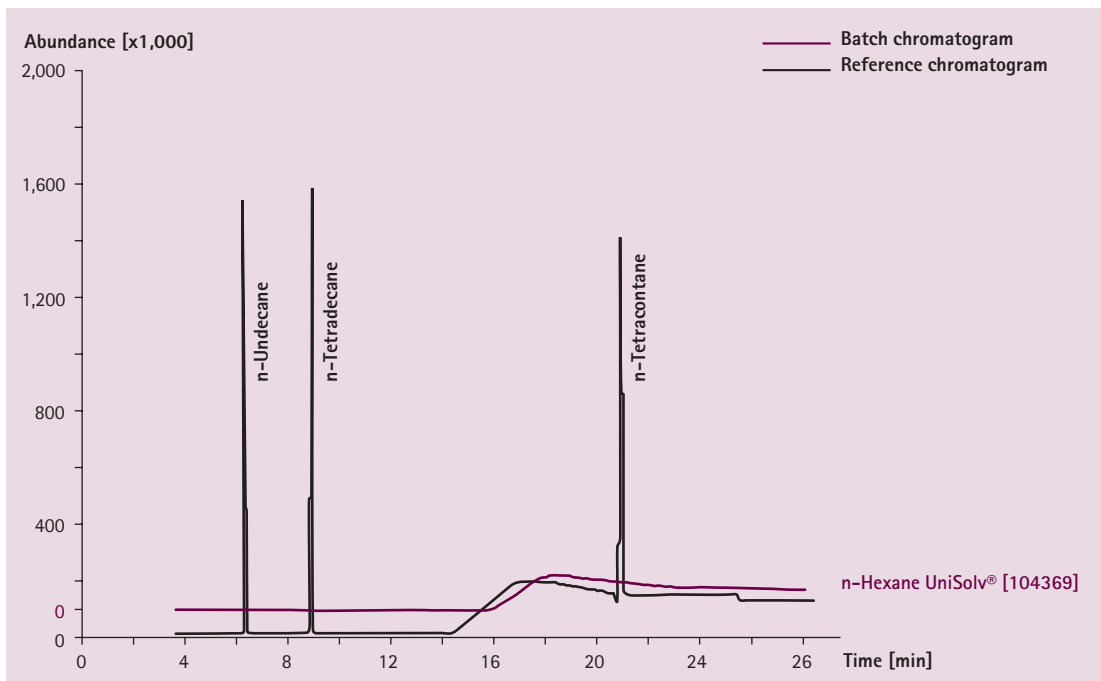

Sorbents for packed columns

The chromatographic column can be filled with an adsorbent (Gas-Solid Chromatography, GSC). For GSC the most frequently used adsorbent is active charcoal.

Active charcoal



Ordering information – Sorbents for Gas-Solid Chromatography, active charcoal

Product	Ordering No.	Particle size [mm]	Particle size [mesh]	Package	Content
Active charcoal	1.09631.0100	0.3 – 0.5	35 – 50	Glass	100 g
Active charcoal	1.09631.0500	0.3 – 0.5	35 – 50	Glass	500 g
Active charcoal	1.09624.0100	0.5 – 1.0	18 – 35	Glass	100 g
Active charcoal	1.09624.0500	0.5 – 1.0	18 – 35	Glass	500 g

Ordering information – Liquid stationary phases

Product	Ordering No.	Solvent	Temperature range [°C]	Package	Content
Dimethyl sulfoxide	1.09678.0100	Acetone	0 – 40	Glass	100 mL
Dinonyl phthalate	1.09669.0100	Acetone / Chloroform	20 – 130	Glass	100 mL
Polyethylene glycol 400 (Carbowax 400)	1.09726.0100	Chloroform	40 – 90	Glass	100 mL
Polyethylene glycol 4000 (Carbowax 4000)	1.09727.0100	Chloroform	50 – 150	Plastic	100 g
Silicone oil 550	1.09762.0100	Chloroform	20 – 130	Glass	100 mL
Squalane	1.09766.0100	Chloroform	20 – 120	Glass	100 mL
Triton® X-100	1.12298.0101	Methanol	20 – 180	Glass	100 mL
Triton® X-100	1.12298.1001	Methanol	20 – 180	Glass	1 L

Derivatization reagents

Many substances e.g. readily decomposed or with low volatility can only be investigated chromatographically after conversion to stable, readily volatile derivatives. In many cases, however, a derivatization reaction serves to increase the sensitivity of detection.

The following table provides an overview of the fields of application of the various derivatization reagents provided by Merck Millipore. The table contains acylating, alkylating and silylating reagents and also several ancillary reagents.

Application fields of the derivatization reagents

Substances Reagent	Alcohols	Amines	Carboxylic acids
Bis(trimethylsilyl) acetamide	•	•	•
Bis(trimethyl) trifluoroacetamide	•	•	•
Chlorotrimethylsilane	•	•	•
Heptafluorobutyric anhydride	•	•	–
N-Methyl-bis(trifluoroacetamide)	•	•	–
N-Methyl-N-(trimethylsilyl)-trifluoro acetamide	–	–	–
Trifluoroacetic anhydride	•	•	–
N-(Trimethylsilyl) acetamide	•	•	•
N-(Trimethylsilyl) diethylamine	•	•	–
N-(Trimethylsilyl) imidazole	–	•	•

Derivatization reagents

Ordering information – Derivatization reagents, silylation

Product	Ordering No.	Package	Content
Bis(trimethylsilyl) acetamide, BSA	1.09649.0010	Glass	10 mL
Bis(trimethylsilyl) acetamide, BSA	1.09649.0025	Glass	25 mL
Bis(trimethylsilyl) trifluoroacetamide, BSTFA	1.10255.0005	Glass	5 mL
Bis(trimethylsilyl) trifluoroacetamide, BSTFA	1.10255.0025	Glass	25 mL
Chlorotrimethylsilane, TMCS	1.02333.0100	Glass	100 mL
Chlorotrimethylsilane, TMCS	1.02333.0250	Glass	250 mL
1,1,1,3,3,3-Hexamethyldisilazane, HMDS	1.12186.0025	Glass	25 mL
1,1,1,3,3,3-Hexamethyldisilazane, HMDS	1.12186.0100	Glass	100 mL
N-Methyl-N-(trimethylsilyl)2,2,2-trifluoroacetamide, MSTFA	1.11805.0005	Glass	5 mL
N-(Trimethylsilyl)imidazole, TMSI	1.09771.0005	Glass	5 mL

Ordering information – Derivatization reagents, acylation

Product	Ordering No.	Package	Content
Trifluoroacetic anhydride, TFAA	1.12513.0010	Glass	10 mL

Reference substances

Reference substances can be used for the identification of unknown compounds in a gas chromatogram or as standards in quantitative GC analysis. They serve also for the characterization of GC column properties.

Reference substances benefits:

- Largely free from isomers
- Particularly pure substances
- Assay usually over 99.5 %

Merck Millipore offers a broad range of particularly pure substances as reference substances for GC. The great majority of those reference substances are completely synthetic in origin and, hence, largely free from isomers that are difficult to separate by GC. Their assay is generally greater than 99 % usually over 99.5 or 99.7 %.

To ensure highest quality each pack comes with a gas chromatogram which was generated under appropriate test conditions. The reference substances belonging to the hydrocarbon group are packed in pierceable ampoules, the fatty acid methyl esters and other reference substances in screw-capped glass vials.

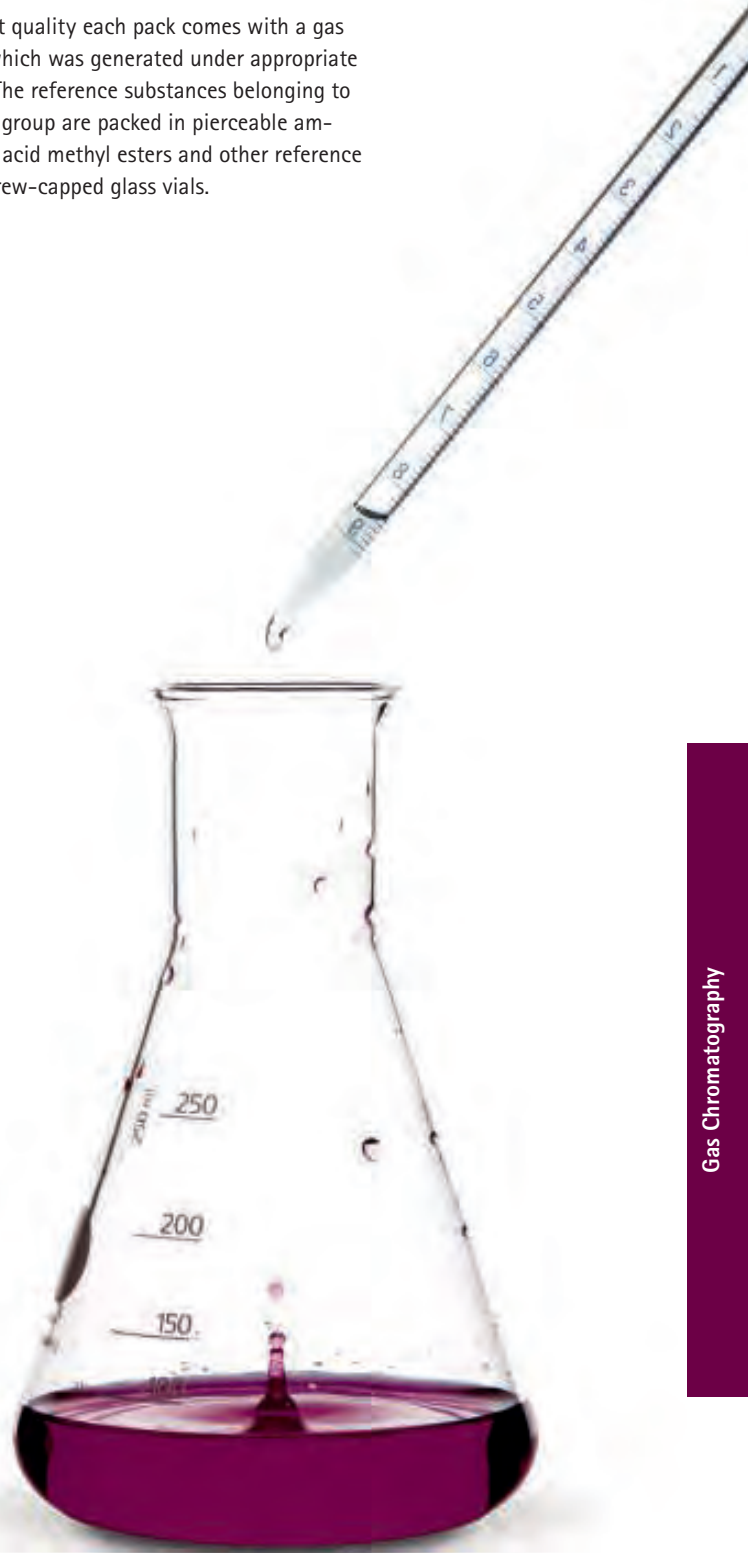

Reference substances

Ordering information – Hydrocarbons C5

Product	Ordering No.	Assay [%]	Empirical formula	Content / Packaging
2-Methylbutane	1.09643.0005	≥99.7	C ₅ H ₁₂	5 mL GA
n-Pentane	1.09719.0005	≥99.7	C ₅ H ₁₂	5 mL GA

GA = glass ampoule

Ordering information – Hydrocarbons C6

Product	Ordering No.	Assay [%]	Empirical formula	Content / Packaging
Benzene	1.09646.0005	≥99.9	C ₆ H ₆	5 mL GA
n-Hexane	1.09687.0005	≥99.7	C ₆ H ₁₄	5 mL GA

GA = glass ampoule

Ordering information – Hydrocarbons C7

Product	Ordering No.	Assay [%]	Empirical formula	Content / Packaging
n-Heptane	1.09686.0005	≥99.5	C ₇ H ₁₆	5 mL GA
3-Methylhexane	1.09703.0005	≥99.0	C ₇ H ₁₆	5 mL GA
Toluene	1.09768.0005	≥99.7	C ₇ H ₈	5 mL GA

GA = glass ampoule

Ordering information – Hydrocarbons C8

Product	Ordering No.	Assay [%]	Empirical formula	Content / Packaging
Ethylbenzene	1.09635.0005	≥99.5	C ₈ H ₁₀	5 mL GA
n-Octane	1.09716.0005	≥99.0	C ₈ H ₁₈	5 mL GA
o-Xylene	1.09798.0005	≥99.0	C ₈ H ₁₀	5 mL GA
m-Xylene	1.09797.0005	≥99.3	C ₈ H ₁₀	5 mL GA
p-Xylene	1.09799.0005	≥99.5	C ₈ H ₁₀	5 mL GA

GA = glass ampoule

Ordering information – Hydrocarbons C9 – C18

Product	Ordering No.	Assay [%]	Empirical formula	Content / Packaging
n-Decane	1.09603.0005	≥99.5	C ₁₀ H ₂₂	5 mL GA
n-Dodecane	1.09658.0005	≥99.0	C ₁₂ H ₂₆	5 mL GA
n-Heptadecane	1.09604.0005	≥99.3	C ₁₇ H ₃₆	5 mL GA
n-Hexadecane	1.09605.0005	≥99.0	C ₁₆ H ₃₄	5 mL GA
n-Octadecane	1.09606.0005	≥99.3	C ₁₈ H ₃₈	5 mL GA
n-Pentadecane	1.09607.0005	≥99.5	C ₁₅ H ₃₂	5 mL GA
n-Tetradecane	1.09608.0005	≥99.0	C ₁₄ H ₃₀	5 mL GA
n-Tridecane	1.09609.0005	≥99.5	C ₁₃ H ₂₈	5 mL GA
n-Undecane	1.09794.0005	≥99.5	C ₁₁ H ₂₄	5 mL GA

GA = glass ampoule

Ordering information – Fatty acid methyl esters

Product	Ordering No.	Assay [%]	Empirical formula	Content / Packaging
Methyl decanoate	1.09637.0005	≥99.5	C ₁₁ H ₂₂ O ₂	5 mL GV
Methyl laurate	1.09693.0005	≥99.0	C ₁₃ H ₂₆ O ₂	5 mL GV
Methyl margarate	1.09754.0005	≥99.0	C ₁₈ H ₃₆ O ₂	5 mL GV
Methyl myristate	1.09736.0005	≥99.5	C ₁₅ H ₃₀ O ₂	5 mL GV
Methyl octanoate	1.09633.0005	≥99.5	C ₉ H ₁₈ O ₂	5 mL GV
Methyl oleate	1.09743.0005	≥99.0	C ₁₉ H ₃₆ O ₂	5 mL GV
Methyl stearate	1.09602.0005	≥99.0	C ₁₉ H ₃₈ O ₂	5 g GV

GV = glass vial

Ordering information – Miscellaneous reference substance

Product	Ordering No.	Assay [%]	Empirical formula	Content / Packaging
D-Camphor	1.09656.0005	≥99.0	C ₁₀ H ₁₆ O	5 g GV
Cyclohexanol	1.09667.0005	≥99.0	C ₆ H ₁₂ O	5 mL GV
Ethyl methyl ketone	1.09709.0005	≥99.5	C ₄ H ₈ O	5 mL GV

GV = glass vial



08

Service



www.merckmillipore.com/chromatography

No matter how challenging your task, we'll guide you to the right products and information to help you succeed. For easier navigation, ChromBook includes lists of all our products, by name or ordering number. If you prefer to do your research online, our website offers a convenient Product Finder, a customizable Application Finder, numerous interactive tools, plus a wealth of information on our Learning Center. Should you need further advice, our experienced service teams around the world are always ready to help. Wherever you are, whatever you need – Merck Millipore is your reliable partner in chromatography.

08

Service

Subject index	page 465
Index of ordering numbers	page 468
Analytical Application Finder	page 475
Merck Millipore around the world	page 476
Learning Center	page 483



Subject index

A Page

Accessories for TLC _____ 135
Accessories for particulate HPLC columns _____ 370, 373, 375
Acetone _____ 19, 137, 446, 447
Acetonitrile _____ 19, 22, 23, 24, 25, 26, 27, 28, 137, 446, 447
Acetonitrile gradient grade _____ 19, 22
Active charcoal _____ 456
Acylation _____ 458
ADS = Alkyl-DIOL-Silica _____ 68
Alkaline stable HPLC separations _____ 276, 345
Alumina particles _____ 345
Aluminium oxide _____ 101, 132, 134
Aluminium oxide for preparative chromatography _____ 404
Aluminium oxide TLC plates _____ 101, 134
Aluminium backed _____ 99, 101, 104, 108, 111, 113, 114
Aluspher® RP-select B _____ 345, 346
Amberjet® _____ 78
Amberlite® _____ 76, 78, 79
Amberlyst® _____ 76
Amines from Azo Dyes _____ 303
Amino shielding _____ 304
Aminopropyl-modified silica gel HPLC columns _____ 199, 240, 312, 336, 408
Amount of alkyl chains _____ 264
Analytical Application Finder _____ 475
Application of LiChrolut® EN _____ 61, 62
Aqueous mobile phase _____ 158, 269, 278, 286, 304
Automated multiple development (AMD) _____ 104, 107
Avicel® _____ 415

B Page

Baseline (Trouble-Shooting) _____ 397
Benzene _____ 460
Beta-cyclodextrin _____ 364
Bimodal porous silica rod _____ 250
Bulk sorbents for preparation of TLC plates _____ 133

C Page

C2 modification _____ 108
C8 modification (HPLC and TLC) _____ 68, 108, 188, 192, 194, 196, 199, 201, 202, 207, 230, 244, 262, 283, 308, 309, 312, 325, 329, 342, 408, 410
C9 – C18 _____ 461

C18 modification (HPLC and TLC) _____ 56, 68, 108, 116, 132, 156, 192, 194, 199, 207, 214, 250, 254, 262, 269, 302, 304, 306, 308, 314, 320, 410
Capacity _____ 50, 51, 52, 53, 58, 60, 66, 76, 309, 313
CARS _____ 434, 435
Cartridge system _____ 370, 373, 374, 380
Cellulose packing materials _____ 415
Cellulose TLC and HPTLC _____ 113, 134
Certified reproducibility _____ 313
Characterization of Purospher® _____ 264, 274
ChiraDex® _____ 364
Chiral HPLC columns _____ 363, 364
Chiral separation _____ 363, 364
Chiral stationary phases _____ 364
Chloroform, stabilized _____ 19, 137, 446
Chromolith® CapRod® _____ 201
Chromolith® CN _____ 234
Chromolith® column coupler _____ 248
Chromolith® DIOL _____ 236
Chromolith® Flash _____ 217, 218, 228, 240
Chromolith® guard cartridges and cartridge kits _____ 243
Chromolith® HPLC columns _____ 200, 206
Chromolith® HighResolution columns _____ 215, 314
Chromolith® NH₂ _____ 240
Chromolith® Phenyl _____ 232
Chromolith® Prep _____ 254, 417
Chromolith® RP-18 endcapped _____ 214
Chromolith® RP-8 endcapped _____ 230
Chromolith® SemiPrep _____ 250
Chromolith® Si _____ 238
Chromolith® SpeedROD _____ 217, 218, 219, 240
Chromolith® Performance _____ 217, 218, 229, 240
Classical silica TLC plates (TLC) _____ 98
Classical TLC _____ 97
CN-modified silica gel HPLC columns _____ 234, 312, 334
CN-, Diol- and NH₂-modified plates (TLC and HPTLC) _____ 111
Column accessories _____ 243, 248, 255, 370, 373, 375
Column care and use _____ 380
Column coupling _____ 207, 214, 230, 232, 234, 236, 238, 248
Column dimension _____ 198
Column equilibration _____ 381
Column hardware _____ 380
Column installation _____ 381
Column length (Preparative HPLC) _____ 425
Column lifetime _____ 382
Column performance _____ 381
Column regeneration _____ 385
Column selection guide _____ 188
Column storage _____ 384
Column void time _____ 386
Concentrating zone plates (TLC, HPTLC, PLC) _____ 116

Cost savings _____ 213
Customized HPLC column packings _____ 366
Customized pre-packed preparative columns _____ 419
Cyanopropyl-modified silica gel HPLC columns _____ 234, 312, 334
Cyclohexane _____ 20, 137, 446, 447

D Page

Detector selection (HPLC) _____ 151
Derivatization reagents (GC) _____ 457
Dichloromethane _____ 20, 446, 447, 452
DIOL-modified silica gel HPLC columns _____ 236, 312, 313, 338
Dowex® _____ 76, 78
Down-scaling _____ 421
Durapore® _____ 81, 82, 83, 84, 87, 88, 89

E Page

Elix® Advantage System _____ 37, 40
Enantiomer _____ 188, 363, 364
Enantioseparation _____ 363
Endfittings _____ 370, 371, 373, 375
Engelhardt test _____ 264, 266
Equilibration (Trouble-Shooting) _____ 391
Ethanol gradient grade _____ 20, 22
Ethyl vinyl benzene divinyl benzene polymer _____ 60
Ethyl acetate _____ 20, 28, 137, 446, 447
Exclusion chromatography _____ 338
EXtrelut® _____ 49, 50
EXtrelut® NT _____ 50, 51
EXtrelut® NT accessories _____ 53
EXtrelut® NT refill packs and bulk materials _____ 52
EXtrelut® NT working principle _____ 50
EXtrelut® NT1, EXtrelut® NT3 and EXtrelut® NT20 _____ 51
EXtrelut® sorbents _____ 49, 52

F Page

Fatty acid methyl esters _____ 461
Florisil® packing materials _____ 416
Florisil® _____ 56, 57, 58, 416
Flow gradients _____ 209, 214, 230, 232, 234, 236, 238
Flow programming _____ 209
Fluorescent indicators _____ 103
Fluoropore™ _____ 81, 82, 83
Fraction range of LiChrospher® _____ 313

Subject index

G Page

Gas Chromatography _____ 440, 441, 443
Glass backed _____ 99, 104, 108, 109, 111,
113, 114, 117, 123, 125, 132
GLP plates (TLC and HPTLC) _____ 125
Gradient grade _____ 19, 20, 21, 22, 23

H Page

Hexagon _____ 262, 264, 277
Hibar® columns _____ 375, 418, 419
Hibar® customized pre-packed columns _____ 419
Hibar® pre-packed columns _____ 418
High performance silica plates (HPTLC) _____ 103
High purity solvents _____ 17, 18, 28, 444
High purity solvents for gas chromatography _____ 444
High separation efficiency _____ 161, 207, 210, 269, 289
High throughput _____ 90, 106, 157, 201, 214, 230,
232, 234, 236, 238, 431
Higher sample throughput _____ 207, 208
Highly porous monolithic rods _____ 200, 203, 206, 240
Highly pure stationary phases (Type B) _____ 192
High-purity silica _____ 157, 214, 238, 286,
289, 302, 304, 306
HPTLC _____ 97, 103, 106, 108, 111,
113, 116, 119, 124, 125, 126
HPTLC-MS _____ 126
Hydrocarbons _____ 460, 461
Hydrophobicity _____ 264
Hydroxyl _____ 57, 156, 181, 236, 312, 404, 408
Hypergrade _____ 17, 18, 24

I Page

Inclusion type phases _____ 364
Injection volume (Preparative HPLC) _____ 422
Instrumental influence (Preparative HPLC) _____ 426
Ion chromatography _____ 432, 434
Ion exchange capacity _____ 264, 277
Ion exchange chromatography _____ 336
Ion exchanger _____ 74, 76, 77, 77, 78
Ion exchangers for sample preparation _____ 74
Irregular _____ 60, 342, 403, 404, 408, 414
Irregular particles (Sample Preparation,
Analytical and Preparative HPLC) _____ 56, 342,
404, 406, 407, 408, 414
Isocratic grade _____ 19, 21, 23
Isohexane _____ 20, 446
Isooctane _____ 20, 137, 446

K Page

Kieselguhr and mixed layer plates _____ 102

L Page

Lab Water Purification _____ 37
Leaks (Trouble-Shooting) _____ 396
Learning Center _____ 483
LiChroCART® _____ 370, 373
LiChrolut® _____ 56, 58
LiChrolut® EN _____ 60
LiChrolut® extraction unit and drying attachment _____ 64
LiChrolut® RP-18 _____ 58, 60
LiChrolut® selection guide _____ 57
LiChrolut® sorbents _____ 43, 58
LiChroprep® _____ 408
LiChropur® reagents for analytical HPLC _____ 43
LiChrosolv® _____ 17, 18, 24
LiChrosolv® gradient grade products _____ 22
LiChrosolv® hypergrade _____ 17, 24
LiChrosorb® _____ 342
LiChrospher® _____ 312
LiChrospher® ADS _____ 48, 66, 68, 70
LiChrospher® CN _____ 312, 334
LiChrospher® DIOL _____ 312, 338
LiChrospher® HPTLC _____ 106
LiChrospher® NH₂ _____ 312, 336
LiChrospher® PAH _____ 312, 322
LiChrospher® RP-18 _____ 312, 314, 418
LiChrospher® RP-18 endcapped _____ 312, 314, 418
LiChrospher® RP-8 _____ 312, 325, 418
LiChrospher® RP-8 endcapped _____ 312, 325
LiChrospher® RP-select B _____ 312, 329, 418
LiChrospher® Si 60 and Si 100 _____ 312, 340, 418
LiChrospher® WP 300 RP-18 _____ 312, 320
LiChroTest® _____ 378
Liquid stationary phases _____ 456
Liquid-liquid extraction _____ 48, 50, 51
log *P* value _____ 190
Low ppb trace range _____ 24
LuxPlate® _____ 99

M Page

Magnesia-loaded silica gel _____ 56
manu-CART® _____ 370
Mass overload (Preparative HPLC) _____ 424
Membrane Filters _____ 84
Merck Millipore around the world _____ 476
Methanol gradient grade _____ 21, 22
Methanol hypergrade _____ 21, 25
Method development (HPLC) _____ 148
Method validation (HPLC) _____ 164
Millex® _____ 19, 80, 81, 85, 88
Millex Simplicity® _____ 85, 90, 93
Millex® Syringe Filters _____ 80, 81, 85, 88
Milli-Q® Advantage A10® system _____ 37, 41
Milli-Q® Integral System _____ 37, 42
Mobile Phases & Reagents for HPLC and TLC _____ 14, 17
Mobile phase selection (HPLC) _____ 158, 382
Monolithic _____ 200, 201, 206, 214, 240, 254

Monolithic silica _____ 146, 194, 200, 201,
230, 232, 234, 236, 238, 250
Monolithic silica gel _____ 192, 194, 196, 199, 200, 201
Multiformat plates (TLC and HPTLC) _____ 124

N Page

NH₂-modified silica gel HPLC columns _____ 199, 240,
289, 312, 336, 408
n-Heptane _____ 20, 137, 446, 460
n-Hexane _____ 20, 28, 137, 446, 447, 452, 460
Non-modified silica gel HPLC columns (Si) _____ 192,
194, 199, 238, 254, 289, 312, 313,
340, 342, 343, 406, 408, 410
Normal phase HPLC _____ 156, 192, 194, 199, 380

O Page

Octadecyl _____ 192, 194, 199, 308, 312, 314,
320, 322, 342, 408
Octyl _____ 192, 194, 199, 308, 312, 325, 342, 408
Omnipore® _____ 84
Operational Qualification (OQ) _____ 378, 379
Overall chromatographic properties _____ 264

P Page

Packing stand _____ 260
PAH _____ 24, 108, 116, 188, 191,
232, 312, 322, 444, 445
PAH trace analysis _____ 322
Particulate HPLC columns and sorbents _____ 262, 308,
312, 342, 345, 348, 363, 366
Peak symmetry _____ 196, 208, 215, 262, 268, 283, 302
Peaks (Trouble-Shooting) _____ 391
PEI Cellulose _____ 115
Performance Qualification (PQ) _____ 378
Pharmaceutical analysis _____ 164, 181, 318
Pharmacopeia _____ 139, 164, 182, 378
Pharmacopeial requirements _____ 174
PharmPrep® P sorbent _____ 410
Phenols _____ 188, 191, 332
pH stability (HPLC) _____ 383
Plastic backed _____ 100, 113, 115
PLC _____ 116, 132, 133
Polybutadiene (PBD) _____ 345
Polycyclic aromatic hydrocarbons (PAH) _____ 108, 116,
322, 444
Poly-L-lysine peptides _____ 321
Pre-coated plates _____ 97, 133, 139
Precolumns _____ 72, 370, 374, 375
Preparative chromatography _____ 28, 260, 404, 424
Preparative HPLC _____ 151, 400, 403, 427, 431
Preparative layer plates (PLC) _____ 132
Preparative Liquid Chromatography _____ 410

Prepsolv®	17, 284
Pressure stability	382
Pressure (Trouble-Shooting)	398
ProteoChrom® HPTLC plates for peptide analysis	119
Proteomics	149, 201, 229
Purospher®	262
Purospher® RP-18	304
Purospher® RP-18 endcapped	302
Purospher® RP-18 HC	306
Purospher® STAR 262, 269, 283, 286, 289, 292, 299	
Purospher® STAR columns for LC-MS applications	299
Purospher® STAR NH ₂	289
Purospher® STAR Phenyl	286
Purospher® STAR RP-18 endcapped	269
Purospher® STAR RP-8 endcapped	283
Purospher® STAR Si	289
Purospher® STAR Si (Silica) and NH ₂ (Amino-phase)	289
Purospher® STAR UHPLC columns	292

R Page

Reagents for HPLC and TLC	17
Recovery (Trouble-Shooting)	396
Reference substances (GC)	459
Restricted access materials (RAM)	66
Retention (Trouble-Shooting)	389
Reversed phase chromatography	214, 230, 240, 336
RP-modified silica plates (TLC and HPTLC)	108
RP-modified silica gel	106, 108, 119, 132
RP-2 (TLC)	108
RP-8 (TLC)	108
RP-18 (TLC)	108

S Page

Sample filtration	80, 81, 84, 85, 88, 90, 92
Sample preparation	44, 48, 150
Samplicity®	49, 90, 92
SAMS	434
Scaling the separation	420, 430
Select B	329, 345
Selection guide	57, 188
Selectivity optimization (HPLC)	160
Selectivity (Trouble-Shooting)	397
Semi-preparative columns	198, 355, 380
Semi-preparative HPLC	427
Separation efficiency (Preparative HPLC)	423
Separation of enantiomers	363, 364
Separation of polar and hydrophilic compounds	350
Separation performance	126, 313
Separation under aqueous conditions	304
SeQuant® SAMS & CARS suppressor system	434
SeQuant® ZIC®-HILIC	348, 354
SeQuant® ZIC®-cHILIC	359
SeQuant® ZIC®-pHILIC	362
Silanol capacity	264, 277

Silica carrier	308
Silica columns	200, 380, 443
Silica gels for preparative HPLC	406
Silylation	458
Stable reversed phase stationary phase	346
Solid-phase extraction	48, 56, 58, 60, 65
Solvent Management System	29
Solvents for gas chromatography	444, 445
Solvents for HPLC	14, 18, 28
Sorbents	49, 52, 61, 66, 69, 133, 194, 262, 264, 308, 309, 312, 314, 325, 329, 330, 334, 335, 336, 337, 338, 339, 340, 342, 343, 348, 366, 369, 403, 408, 410, 419, 456
Sorbents for packed columns (GC)	456
Specification of column sorbents	188, 194
Speed of analysis	200, 206, 208
Stahl	136
Stainless steel cartridges LiChroCART®	270, 271, 273, 284, 287, 290, 302, 304, 306, 310, 311, 316, 320, 323, 327, 331, 335, 337, 339, 341, 344, 346, 365, 367, 371, 373
Stainless steel columns Hibar®	272, 284, 287, 290, 293, 305, 309, 315, 320, 322, 326, 330, 335, 337, 339, 341, 344, 346, 365, 368
Standardized silica gels	406
Stationary phase selection (HPLC)	155, 188, 192, 194
Steric selectivity	264, 277
Superspher®	308
Suppressor system	434
SupraSolv® solvents for gas chromatography	445, 448
System optimization	161

T Page

Tailor-made solvents	444
Tanaka test	264, 277
Technical appendix	136
Temperature stability (HPLC)	383
tert-Butyl methyl ether	19, 137, 446
Tetrahydrofuran	21, 137
Thin layer chromatography (TLC)	94, 97
TLC and HPTLC MS-grade plates for mass spectrometry	126
TLC plates (silica)	98
TLC silica gel 60G plates	122
Toluene	21, 137, 425, 447, 460
Trouble-Shooting (HPLC)	388

U Page

UHPLC columns	262, 292
Ultra-fast separation	218, 225, 227, 292
Ultrapure water	37
UniSolv®	443, 452
UniSolv® solvents for organic trace analysis	452
Up-scaling	420, 427
USP column classification (HPLC)	194, 199

V Page

Volume overload (Preparative HPLC)	423
------------------------------------	-----

W Page

Water	21, 22, 25, 26, 448
Water purification	37
Wide-pore kieselguhr	50

Z Page

ZIC®-HILIC	348, 354
ZIC®-cHILIC	359
ZIC®-pHILIC	362

Numerics Page

1-Butanol	19
1-Chlorobutane	19
1,2-Dichloroethane	20
1,4-Dioxane	20
1-Propanol	21
2-Propanol	21, 22, 28, 448

Index of ordering numbers

Ordering No.	Page	Ordering No.	Page	Ordering No.	Page	Ordering No.	Page	Ordering No.	Page
1.00...		1.00424.7080	315	1.01024.2500	21	1.01900.2500	448	1.03831.0001	31, 34
1.00012.1000	446	1.00424.7081	315	1.01024.4000	21	1.01988.1000	19	1.03832.0001	31
1.00012.2500	446	1.00424.7084	315	1.01040	22	1.01988.2500	19	1.03833.0001	31
1.00012.4000	446	1.00424.7091	326	1.01040.1000	21	1.01995.1000	446	1.03834.0001	31
1.00012.9030	446	1.00424.7101	341	1.01040.2500	21	1.01995.2500	446	1.03835.0001	31
1.00017.1000	446	1.00424.7109	341	1.01040.4000	21	1.02...		1.03836.0001	31
1.00017.2500	446	1.00424.7127	305	1.01040.5000	21	1.02014.0001	58	1.04...	
1.00017.4000	446	1.00424.7137	309	1.01040.9010	21	1.02016.0001	58	1.04335.2500	20
1.00020.1000	19	1.00424.7220	284	1.01040.9030	21	1.02021.0001	58	1.04340.2500	446
1.00020.2500	19	1.00480.0100	135	1.01060.9050	405	1.02022.0001	58	1.04360.1000	446
1.00020.4000	19	1.00577.1000	448	1.01061.1000	405	1.02023.0001	58	1.04360.2500	446
1.00020.5000	19	1.00577.2500	448	1.01061.2000	405	1.02024.0001	58	1.04369.1000	452
1.00020.9010	19	1.00586.0500	76	1.01067.1000	405	1.02035.0100	135	1.04369.2500	452
1.00020.9050	19	1.00658.1000	447	1.01067.2000	405	1.02122.0001	58	1.04371.1000	446
1.00029.1000	19, 25	1.00658.2500	447	1.01076.1000	405	1.02129.0001	207, 217	1.04371.2500	446
1.00029.2500	19, 25	1.00665.1000	447	1.01076.2000	405	1.02206.0001	64	1.04371.4000	446
1.00029.9010	19, 25	1.00665.2500	447	1.01076.9020	405	1.02330.0500	134	1.04371.9010	446
1.00029.9030	19, 25	1.00667.1000	447	1.01077.1000	405	1.02331.0500	415	1.04371.9030	446
1.00030	22	1.00667.2500	447	1.01077.2000	405	1.02331.2500	415	1.04390.1000	20
1.00030.1000	19	1.00668.1000	447	1.01077.9020	405	1.02331.9025	415	1.04390.2500	20
1.00030.2500	19	1.00668.2500	447	1.01078.1000	405	1.02333.0100	458	1.04390.9010	20
1.00030.4000	19	1.00789.1000	447	1.01078.2000	405	1.02333.0250	458	1.04390.9030	20
1.00030.5000	19	1.00789.2500	447	1.01078.9020	405	1.02371.1000	446	1.04390.9185	20
1.00030.9010	19	1.00795.1000	447	1.01090.2500	134	1.02371.2500	446	1.04391.1000	20
1.00030.9030	19	1.00795.2500	447	1.01090.9025	134	1.02371.4000	446	1.04391.2500	20
1.00030.9185	19	1.00837.1000	447	1.01092.0500	134	1.02432.1000	446	1.04391.4000	20
1.00202.0500	448	1.00837.2500	447	1.01097.1000	405	1.02432.2500	446	1.04391.5000	20
1.00202.0501	448	1.00849.1000	447	1.01097.5000	405	1.02444.1000	19	1.04391.9010	20
1.00202.1000	448	1.00849.2500	447	1.01097.9050	405	1.02444.2500	19	1.04391.9030	20
1.00202.2500	448	1.00868.1000	20	1.01111.0001	34	1.02444.4000	19	1.04391.9185	20
1.00384.0001	123	1.00868.2500	20	1.01123.0001	33	1.02444.9010	19	1.04394.9030	28
1.00390.0001	123	1.00868.4000	20	1.01692.1000	19	1.02497.0500	448	1.04717.1000	20
1.00399.0500	448	1.00868.9010	20	1.01772.1000	447	1.02497.1000	448	1.04717.2500	20
1.00399.1000	448	1.00882.1000	447	1.01772.2500	447	1.02497.2500	448	1.04765.0500	76
1.00423.	368	1.00882.2500	447	1.01772.4000	447	1.02817.1000	446	1.04765.5000	76
1.00423.7079	315	1.00882.4000	447	1.01772.9010	447	1.02817.2500	446	1.04767.0500	78
1.00423.7087	326	1.00931.1000	446	1.01845.1000	19	1.02817.4000	446	1.04767.5000	78
1.00423.7137	309	1.00931.2500	446	1.01845.2500	19	1.02817.9010	446	1.04768.0500	78
1.00424.	368	1.00933.0001	129	1.01845.9010	19	1.02827.1000	20	1.04768.5000	78
1.00424.7054	344	1.00934.0001	129	1.01845.9030	19	1.02827.2500	20	1.04835.0500	77
1.00424.7059	344	1.00998.1000	447	1.01845.9185	19	1.03...		1.04835.5000	77
1.00424.7071	335	1.00998.2500	447	1.01900.0500	448	1.03132.1000	20	1.04836.0500	79
1.00424.7075	339	1.01...		1.01900.0501	448	1.03132.2500	20	1.04836.5000	79
1.00424.7077	337	1.01024.1000	21	1.01900.1000	448	1.03830.0001	31, 34		

Index of ordering numbers

Ordering No.	Page	Ordering No.	Page	Ordering No.	Page	Ordering No.	Page	Ordering No.	Page
1.05...		1.05650.0001	119	1.06018.5000	21	1.07747.9025	133	1.09607.0005	461
1.05221.0250	76	1.05651.0001	119	1.06018.9010	21	1.07748.1000	133	1.09608.0005	461
1.05238.0250	76	1.05702.0001	125	1.06018.9030	21	1.07748.2500	133	1.09609.0005	461
1.05242.0250	78	1.05713.0001	101	1.06018.9185	21	1.07749.1000	133	1.09624.0100	456
1.05245.0500	78	1.05714.0001	99	1.06035.1000	21, 25	1.07749.2500	133	1.09624.0500	456
1.05434.0001	132	1.05715.0001	99, 123	1.06035.2500	21, 25	1.07749.9025	133	1.09631.0100	456
1.05533.0001	111	1.05716.0001	113	1.06044.1000	20	1.07754.0500	407	1.09631.0500	456
1.05547.0001	104	1.05717.0001	132	1.06044.2500	20	1.07754.1000	407	1.09633.0005	461
1.05548.0001	104	1.05718.0001	113	1.06044.4000	20	1.08...		1.09635.0005	460
1.05549.0001	99	1.05719.0001	99	1.06044.9010	20	1.08101.1000	21	1.09637.0005	461
1.05550.0001	101	1.05721.0001	99	1.06044.9030	20	1.08101.2500	21	1.09643.0005	460
1.05551.0001	101	1.05724.0001	99	1.06054.1000	446	1.08101.4000	21	1.09646.0005	460
1.05552.0001	113	1.05725.0001	115	1.06054.2500	446	1.08101.9010	21	1.09649.0010	458
1.05553.0001	99	1.05726.0001	132	1.06054.4000	446	1.08101.9030	21	1.09649.0025	458
1.05554.0001	99	1.05728.0001	113	1.06054.9010	446	1.08327.1000	21	1.09656.0005	461
1.05556.0001	104	1.05729.0001	99	1.06454.1000	452	1.08327.2500	21	1.09658.0005	461
1.05559.0001	108	1.05730.0001	113	1.06705.0100	135	1.08327.4000	21	1.09667.0005	461
1.05560.0001	108	1.05731.0001	101	1.06710.0001	33	1.08389.1000	447	1.09669.0100	456
1.05562.0001	99	1.05735.0001	100	1.07...		1.08389.2500	447	1.09678.0100	456
1.05563.0001	113	1.05738.0001	102	1.07027.1000	407	1.08389.4000	447	1.09686.0005	460
1.05564.0001	125	1.05744.0001	132	1.07027.9025	407	1.08540.0001	135	1.09687.0005	460
1.05565.0001	113	1.05745.0001	132	1.07070.0001	33	1.08541.0001	135	1.09693.0005	461
1.05566.0001	125	1.05746.0001	108	1.07288.1000	452	1.08803.0001	33	1.09703.0005	460
1.05567.0001	102	1.05747.0001	108	1.07288.2500	452	1.09...		1.09709.0005	461
1.05568.0001	102	1.05748.0001	100	1.07719.0250	414	1.09303.0100	409	1.09716.0005	460
1.05570.0001	99	1.05749.0001	100	1.07719.1000	414	1.09303.0500	409	1.09719.0005	460
1.05574.0001	113	1.05750.0001	100	1.07729.1000	407	1.09303.5000	409	1.09726.0100	456
1.05577.0001	113	1.05786.0001	114	1.07729.5000	407	1.09303.9025	409	1.09727.0100	456
1.05579.0001	115	1.05787.0001	114	1.07729.9025	407	1.09309.0010	343	1.09736.0005	461
1.05581.0001	101	1.05788.0001	132	1.07730.1000	133	1.09318.0010	343	1.09743.0005	461
1.05582.0001	116	1.05789.0001	99	1.07730.5000	133	1.09318.0100	343	1.09754.0005	461
1.05583.0001	116	1.05801.0001	99	1.07730.9025	133	1.09332.0010	343	1.09762.0100	456
1.05586.0001	107	1.05802.0001	99	1.07731.1000	133	1.09333.0010	343	1.09766.0100	456
1.05608.0001	124	1.05804.0001	99	1.07731.5000	133	1.09334.0010	343	1.09768.0005	460
1.05613.0001	125	1.05805.0001	99	1.07731.9025	133	1.09336.1000	409	1.09771.0005	458
1.05616.0001	104	1.05808.0001	99	1.07733.0500	407	1.09336.9025	409	1.09794.0005	461
1.05620.0001	124	1.05914.0001	109	1.07733.1000	407	1.09362.0250	409	1.09797.0005	460
1.05626.0001	99	1.06...		1.07733.5000	407	1.09362.1000	409	1.09798.0005	460
1.05628.0001	104	1.06007	22	1.07733.9025	407	1.09385.1000	407	1.09799.0005	460
1.05629.0001	104	1.06007.1000	21	1.07734.1000	407	1.09385.2500	407	1.10...	
1.05631.0001	104	1.06007.2500	21	1.07734.2500	407	1.09385.5000	407	1.10255.0005	458
1.05632.0001	113	1.06007.4000	21	1.07734.5000	407	1.09385.9025	407	1.10255.0025	458
1.05633.0001	104	1.06007.5000	21	1.07734.9025	407	1.09387.0100	343	1.10290.0001	135
1.05635.0001	124	1.06007.9010	21	1.07736.1000	133	1.09389.1000	407	1.10646.0001	135
1.05636.0001	111	1.06007.9030	21	1.07736.2500	133	1.09389.5000	407	1.10647.0001	135
1.05637.0001	132	1.06007.9185	21	1.07736.9025	133	1.09389.9025	407	1.10757.1000	407
1.05641.0001	104	1.06011.1000	447	1.07739.1000	133	1.09360.1000	409	1.10832.1000	407
1.05642.0001	104, 128	1.06011.2500	447	1.07739.2500	133	1.09602.0005	461	1.10832.2500	407
1.05644.0001	104, 124	1.06011.4000	447	1.07739.9025	133	1.09603.0005	461	1.10832.9025	407
1.05646.0001	107	1.06018.1000	21	1.07741.1000	133	1.09604.0005	461	1.10972.1000	446
1.05647.0001	107	1.06018.2500	21	1.07747.1000	133	1.09605.0005	461	1.10972.2500	446
1.05648.0001	104	1.06018.4000	21	1.07747.2500	133	1.09606.0005	461	1.10972.4000	446

Index of ordering numbers

Ordering No.	Page	Ordering No.	Page	Ordering No.	Page	Ordering No.	Page	Ordering No.	Page
1.10972.9010	446	1.13358.9910	28	1.15127.5000	79	1.16105.0010	314	1.19618.0010	309
1.10983.1000	446	1.13713.1000	20	1.15131.0500	76	1.16129.0010	325	1.19632.0010	325
1.10983.2500	446	1.13724.0001	109	1.15131.5000	76	1.16139.0010	325	1.19633.0010	314
1.11...		1.13725.0001	109	1.15165.0500	79	1.16152.0010	339	1.19636.0010	325
1.11567.1000	407	1.13726.0001	109	1.15201.0001	379	1.16177.0010	314	1.19637.0010	314
1.11567.2500	407	1.13727.0001	117	1.15256.0500	79	1.16178.0010	337	1.19638.0010	335
1.11567.9025	407	1.13728.0001	117	1.15262.0500	78	1.16217.0001	374, 375	1.19640.0010	340
1.11678.1000	133	1.13748.0001	117	1.15326.0001	99	1.16225.0001	109	1.19640.0100	340
1.11695.1000	133	1.13749.0001	117	1.15327.0001	99	1.16464.0001	111	1.19641.0010	330
1.11727	22	1.13792.0001	117	1.15333	22	1.16484.0001	99	1.19642.0010	330
1.11727.1000	20	1.13793.0001	117	1.15333.1000	21, 25	1.16485.0001	99	1.19642.0100	330
1.11727.2500	20	1.13794.0001	117	1.15333.2500	21, 25	1.16487.0001	99	1.19643.0010	309
1.11727.4000	20	1.13894.0001	132	1.15333.4000	21, 25	1.16740.1000	452	1.19681.0010	411
1.11727.9030	20	1.13895.0001	132	1.15333.9010	21, 25	1.16740.2500	452	1.19681.0100	411
1.11727.9185	20	1.13900.0250	409	1.15333.9030	21, 25	1.16834.0001	99	1.19681.1000	411
1.11764.0001	104	1.13900.1000	409	1.15341.0001	99	1.16835.0001	99	1.19682.0010	411
1.11798.0001	116	1.13900.9025	409	1.15373.0001	53	1.16854.0001	310	1.19682.0100	411
1.11805.0005	458	1.13901.0100	409	1.15388.0001	108	1.16855.0001	311	1.19682.1000	411
1.11844.0001	116	1.13901.0500	409	1.15389.0001	108	1.16857.0001	310	1.19686.0001	58
1.11845.0001	116	1.13901.9010	409	1.15423.0001	108	1.16858.0001	311	1.19687.0001	58
1.11846.0001	116	1.13905.0250	409	1.15424.0001	108	1.16869.0001	311	1.19691.0001	58, 61
1.12...		1.13905.1000	409	1.15440.1000	446	1.18...		1.19693.0001	58, 61
1.12186.0025	458	1.13959.0250	409	1.15440.2500	446	1.18303.0025	43	1.19698.0001	58
1.12186.0100	458	1.13973.0250	409	1.15445.0001	107	1.18304.0025	43	1.19753.0250	43
1.12298.0101	456	1.13974.0250	409	1.15498.0001	117	1.18305.0025	43	1.19754.0250	43
1.12298.1001	456	1.14...		1.15545.0001	377	1.18306.0025	43	1.19767.0001	58
1.12363.0001	104	1.14236.0001	53	1.15546.0001	377	1.18307.0025	43	1.19847.0001	58
1.12463.0500	78	1.14237.0001	53	1.15552.0001	104	1.18308.0025	43	1.19849.0001	58
1.12513.0010	458	1.14291.1000	19	1.15576.0001	373	1.18309.0025	43	1.19851.0001	64
1.12518.0100	416	1.14291.2500	19	1.15622.0001	53	1.18310.0025	43	1.19852.0001	64
1.12518.1000	416	1.14291.4000	19	1.15635.0500	76	1.18312.0025	43	1.19853.0020	61
1.12537.0001	135	1.14291.5000	19	1.15647.0001	111	1.18313.0025	43	1.19855.0001	58
1.12572.0001	111	1.14291.9010	19	1.15683.0001	108	1.19...		1.19870.0001	58, 61
1.12668.0001	111	1.14291.9030	19	1.15684.0001	108	1.19127.0001	58	1.19874.0001	64
1.12994.0100	416	1.14291.9185	19	1.15685.0001	108	1.19132.0010	411	1.19891.0001	64
1.12994.1001	416	1.14296.0001	109	1.15696.0001	104	1.19132.0100	411	1.19902.0001	64
1.13...		1.14567.0001	53	1.15959.0500	78	1.19132.1000	411	1.19912.0001	58, 61
1.13124.0001	109	1.15...		1.15965.0500	79	1.19141.0001	379	1.19941.0001	58, 61
1.13187.0001	117	1.15035.0001	114	1.15966.0500	76	1.19142.0001	379	1.19995.0010	411
1.13192.0001	111	1.15036.0001	114	1.16...		1.19143.0001	379	1.19995.0100	411
1.13203.0001	135	1.15037.0001	117	1.16009.0001	310	1.19144.0001	379	1.19995.1000	411
1.13326.0001	125	1.15092.1000	52	1.16010.0001	310	1.19145.0001	379	1.19996.0010	411
1.13350.2500	28	1.15093.0001	52	1.16010.1003	310	1.19157.0001	379	1.19996.0100	411
1.13350.9910	28	1.15094.0001	51	1.16039.0001	311	1.19158.0001	379	1.19996.1000	411
1.13351.2500	28	1.15095.0001	51	1.16051.0001	311	1.19159.0001	379	1.20...	
1.13351.9030	28	1.15096.0001	51	1.16051.1003	311	1.19161.0001	379	1.20571.0001	411
1.13351.9185	28	1.15101.1000	407	1.16052.0001	310	1.19162.0001	379	1.20572.0001	411
1.13351.9910	28	1.15101.9025	407	1.16052.1003	310	1.19163.0001	379	1.20573.0001	411, 418
1.13353.9030	28	1.15111.1000	407	1.16054.0001	310	1.19165.0001	379	1.20574.0001	411, 418
1.13358.2500	28	1.15111.2500	407	1.16056.0001	311	1.19169.0001	379	1.20575.0001	411
1.13358.9030	28	1.15111.9025	407	1.16056.1003	311	1.19612.0010	309	1.20581.0001	411
1.13358.9185	28	1.15127.0500	79	1.16092.0001	114	1.19613.0010	309	1.20587.0001	411, 418

Index of ordering numbers

Ordering No.	Page	Ordering No.	Page	Ordering No.	Page	Ordering No.	Page	Ordering No.	Page
1.25...		1.50013.7076	337	1.50172.7075	339	1.50182.7076	337	1.50209.0001	68
1.25251.0001	207, 255	1.50013.7081	315	1.50172.7185	271	1.50182.7084	315	1.50210.0001	69
1.25252.0001	207, 255	1.50013.7109	341	1.50173.	367	1.50182.7085	315	1.50225.0001	270
1.25254.0001	255	1.50013.7130	302	1.50174.	367	1.50182.7091	326	1.50226.0001	
1.25255.0001	255	1.50013.7138	309	1.50174.7184	270	1.50182.7093	330	1.50226.0001	270, 271, 284, 367, 370, 371
1.25256.0001	255	1.50017.0001	370, 371	1.50175.	367	1.50182.7101	341	1.50227.0001	
1.25257.0001	255	1.50031.0001	284	1.50175.7075	339	1.50182.7109	341	1.50227.0001	270, 271, 284, 367, 370, 371
1.25259.0001	255	1.50032.0001	284	1.50175.7076	337	1.50182.7137	309	1.50228.	367
1.25260.0001	207, 255	1.50033.0001	284	1.50175.7085	317	1.50182.7138	309	1.50228.7078	323
1.25262.0001	207, 255	1.50035.0001	284	1.50175.7092	327	1.50182.7141	309	1.50228.7079	316
1.25325.0001	207, 255	1.50036.0001	272	1.50175.7127	304	1.50182.7174	290	1.50228.7085	317
1.40...		1.50036.1003	273	1.50175.7174	290	1.50182.7177	290	1.50228.7087	327
1.40140.0001	30	1.50037.0001	272	1.50175.7175	290	1.50183.	368	1.50228.7139	310
1.50...		1.50037.1003	273	1.50175.7184	270	1.50183.7075	339	1.50228.7185	271
1.50004.0001	419	1.50038.0001	284	1.50177.	367	1.50183.7076	337	1.50228.7220	284
1.50009.	368	1.50082.0001	371	1.50177.7075	339	1.50183.7079	315	1.50229.	367
1.50009.7052	344	1.50083.0001	371	1.50177.7076	337	1.50183.7081	315	1.50229.7220	284
1.50009.7070	335	1.50092.0001	419	1.50177.7085	317	1.50183.7084	315	1.50231.0001	270
1.50009.7075	339	1.50099.0001	419	1.50177.7087	327	1.50183.7085	315	1.50233.	367
1.50009.7080	315	1.50117.0001	365	1.50177.7092	327	1.50183.7088	326	1.50233.7079	316
1.50009.7084	315	1.50137.0001	320	1.50177.7109	341	1.50183.7094	330	1.50233.7141	310
1.50009.7091	326	1.50140.0001	320	1.50177.7127	304	1.50183.7109	341	1.50234.	367
1.50009.7104	341	1.50141.0001	304	1.50177.7139	310	1.50183.7127	305	1.50234.7091	327
1.50009.7109	341	1.50142.0001	304	1.50177.7174	290	1.50187.0001	68	1.50234.7185	271
1.50009.7127	305	1.50144.0001	304	1.50177.7177	290	1.50190.	367	1.50234.7220	284
1.50009.7137	309	1.50148.0001	323	1.50177.7184	270	1.50190.7075	339	1.50236.	367
1.50009.7138	309	1.50149.0001	323	1.50178.	367	1.50190.7079	316	1.50236.7084	317
1.50009.7141	309	1.50154.0001	316	1.50179.	367	1.50190.7085	317	1.50236.7091	327
1.50009.7174	290	1.50154.1003	316	1.50179.7088	327	1.50190.7087	327	1.50237.0001	270
1.50009.7175	290	1.50155.0001	331	1.50179.7091	327	1.50190.7109	341	1.50238.0001	270
1.50009.7177	290	1.50155.1003	331	1.50179.7109	341	1.50190.7137	311	1.50239.0001	270
1.50009.7220	284	1.50156.0001	323	1.50179.7116	320	1.50190.7175	290	1.50240.0001	270
1.50012.	368	1.50158.0001	331	1.50179.7127	304	1.50190.7177	290	1.50241.0001	270
1.50012.7057	344	1.50158.1003	331	1.50181.	368	1.50190.7184	270	1.50242.0001	270
1.50012.7071	335	1.50159.0001	316	1.50181.7054	344	1.50193.0001	311	1.50244.0001	290
1.50012.7076	337	1.50159.1003	316	1.50181.7059	344	1.50195.	367	1.50245.0001	290
1.50012.7077	337	1.50167.0001	302	1.50181.7071	335	1.50195.7079	316	1.50247.0001	290
1.50012.7080	315	1.50168.0001	302	1.50181.7076	337	1.50195.7093	331	1.50248.0001	290
1.50012.7084	315	1.50169.0001	302	1.50181.7078	322	1.50195.7109	341	1.50249.0001	290
1.50012.7087	326	1.50170.	367	1.50181.7080	315	1.50195.7116	320	1.50250.0001	271
1.50012.7088	326	1.50170.7077	337	1.50181.7087	326	1.50195.7139	310	1.50251.0001	271
1.50012.7093	330	1.50170.7084	317	1.50181.7088	326	1.50195.7140	310	1.50251.1003	273
1.50012.7109	341	1.50170.7131	306	1.50181.7092	326	1.50197.0001	310	1.50252.0001	271
1.50012.7127	305	1.50171.	367	1.50181.7093	330	1.50198.0001	311	1.50252.1003	273
1.50012.7137	309	1.50171.7071	335	1.50181.7109	341	1.50200.0001	311	1.50253.0001	271
1.50012.7138	309	1.50171.7085	317	1.50181.7116	320	1.50200.1003	311	1.50254.0001	271
1.50012.7139	309	1.50171.7109	341	1.50181.7140	309	1.50201.	367	1.50255.0001	271
1.50012.7140	309	1.50171.7127	304	1.50181.7141	309	1.50204.0001	311	1.50256.0001	271
1.50012.7174	290	1.50171.7131	306	1.50181.7174	290	1.50205.0001	310	1.50257.0001	271
1.50012.7184	272	1.50171.7185	271	1.50182.	368	1.50206.0001	68	1.50267.0001	290
1.50013.	368	1.50171.7220	284	1.50182.7002	346	1.50207.0001	68	1.50268.0001	290
1.50013.7004	365	1.50172.	367	1.50182.7075	339	1.50208.0001	68	1.50269.0001	290

Index of ordering numbers

Ordering No.	Page	Ordering No.	Page	Ordering No.	Page	Ordering No.	Page	Ordering No.	Page
1.50270.0001	284	1.50432.0001	344	1.50492.0001	355	1.50618.0001	436, 438	1.50675.0001	293
1.50271.0001	284	1.50433.0001	344	1.50493.0001	355	1.50619.0001	436, 438	1.50734.0001	317
1.50272.0001	284	1.50434.0001	354	1.50494.0001	355	1.50620.0001	272	1.50742.0001	331
1.50273.0001	284	1.50435.0001	354	1.50495.0001	355	1.50621.0001	272	1.50750.0001	284
1.50274.0001	284	1.50436.0001	354	1.50496.0001	355	1.50622.0001	272	1.50791.0001	310
1.50276.0001	284	1.50437.0001	362	1.50497.0001	355	1.50623.0001	271	1.50792.0001	311
1.50302.	367	1.50438.0001	362	1.50545.0001	315	1.50624.0001	271	1.50792.1003	311
1.50302.7075	339	1.50439.0001	354	1.50545.1003	315	1.50625.0001	271	1.50798.0001	302
1.50302.7076	337	1.50440.0001	354	1.50546.0001	315	1.50626.0001	271	1.50799.0001	302
1.50302.7078	323	1.50441.0001	354	1.50546.1003	315	1.50627.0001	271	1.50820.0001	341
1.50302.7079	316	1.50442.0001	354	1.50547.0001	315	1.50629.0001	293	1.50822.0001	327
1.50302.7084	317	1.50443.0001	354	1.50547.1003	315	1.50630.0001	293	1.50823.0001	316
1.50302.7138	311	1.50444.0001	354	1.50548.0001	315	1.50631.0001	287	1.50823.1003	316
1.50302.7185	271	1.50445.0001	354	1.50549.0001	315	1.50634.0001	327	1.50824.0001	337
1.50302.7220	284	1.50446.0001	354	1.50550.0001	315	1.50635.0001	327	1.50825.0001	335
1.50316.0001	341	1.50447.0001	354	1.50573.0001	330	1.50636.0001	327	1.50826.0001	339
1.50318.0001	344	1.50448.0001	354	1.50573.1003	330	1.50637.0001	327	1.50827.0001	327
1.50329.0001	326	1.50449.0001	354	1.50574.0001	330	1.50638.0001	327	1.50828.0001	317
1.50332.0001	344	1.50450.0001	354	1.50574.1003	330	1.50639.0001	327	1.50829.0001	331
1.50333.0001	344	1.50451.0001	354	1.50575.0001	330	1.50640.0001	331	1.50830.0001	341
1.50334.0001	344	1.50452.0001	354	1.50575.1003	330	1.50640.1003	331	1.50832.0001	327
1.50349.0010	69	1.50453.0001	354	1.50578.0001	326	1.50641.0001	331	1.50833.0001	316
1.50356.0001	290	1.50454.0001	354	1.50579.0001	326	1.50641.1003	331	1.50833.1003	316
1.50357.0001	290	1.50454.1003	354	1.50580.0001	326	1.50642.0001	331	1.50834.0001	337
1.50358.0001	271	1.50455.0001	354	1.50581.0001	326	1.50642.1003	331	1.50836.0001	339
1.50358.1003	273	1.50455.1003	354	1.50582.0001	326	1.50644.0001	284	1.50837.0001	327
1.50359.0001	271	1.50456.0001	355	1.50583.0001	326	1.50645.0001	293	1.50838.0001	317
1.50359.1003	273	1.50457.0001	354	1.50593.0001	272	1.50646.0001	293	1.50839.0001	331
1.50377.0001	315	1.50458.0001	354	1.50595.0001	272	1.50648.0001	293	1.50839.1003	331
1.50377.1003	315	1.50459.0001	362	1.50596.0001	272	1.50648.1003	293	1.50840.0001	341
1.50380.0001	68	1.50460.0001	362	1.50597.0001	272	1.50649.0001	293	1.50842.0001	327
1.50381.0001	68	1.50461.0001	362	1.50598.0001	272	1.50650.0001	293	1.50843.0001	316
1.50382.0001	68	1.50462.0001	362	1.50600.0001	316	1.50651.0001	293	1.50844.0001	337
1.50385.0001	68	1.50463.0001	362	1.50600.1003	316	1.50653.0001	293	1.50845.0001	335
1.50386.0001	68	1.50464.0001	362	1.50601.0001	316	1.50654.0001	293	1.50847.0001	327
1.50388.0001	344	1.50465.0001	355	1.50601.1003	316	1.50655.0001	293	1.50848.0001	317
1.50393.0001	272	1.50466.0001	355	1.50602.0001	316	1.50656.0001	359	1.50850.0001	341
1.50398.0001	272	1.50468.0001	272	1.50602.1003	316	1.50657.0001	359	1.50853.0001	316
1.50400.0001	202	1.50469.0001	272	1.50603.0001	317	1.50658.0001	359	1.50858.0001	317
1.50402.0001	202	1.50470.0001	272	1.50604.0001	317	1.50659.0001	359	1.50892.0001	335
1.50403.0001	202	1.50471.0001	272	1.50605.0001	317	1.50660.0001	359	1.50928.0001	341
1.50404.0001	202	1.50477.0001	315	1.50607.0001	272	1.50661.0001	359	1.50930.0001	327
1.50405.0001	202	1.50477.1003	315	1.50609.0001	436, 438	1.50662.0001	359	1.50931.0001	316
1.50407.0001	202	1.50478.0001	355	1.50610.0001	436, 438	1.50664.0001	359	1.50932.0001	337
1.50409.0001	202	1.50479.0001	355	1.50611.0001	436, 438	1.50665.0001	359	1.50936.0001	317
1.50413.0001	272	1.50480.0001	355	1.50612.0001	272	1.50666.0001	359	1.50937.0001	331
1.50414.0001	272	1.50481.0001	355	1.50613.0001	436, 438	1.50669.0001	359	1.50942.0001	327
1.50424.0001	202	1.50482.0001	355	1.50614.0001	436, 438	1.50670.0001	359	1.50943.0001	316
1.50426.0001	202	1.50487.0001	355	1.50615.0001	272	1.50671.0001	355	1.50947.0001	68
1.50427.0001	272	1.50489.0001	355	1.50616.0100	436, 438	1.50672.0001	293	1.50955.0001	341
1.50428.0001	272	1.50490.0001	355	1.50617.0001	272	1.50673.0001	293	1.50956.0001	327
1.50431.0001	272	1.50491.0001	355	1.50617.1003	273	1.50674.0001	293	1.50957.0001	316

Index of ordering numbers

Ordering No.	Page	Ordering No.	Page	Ordering No.	Page	Ordering No.	Page	Ordering No.	Page
1.50958.0001	337	1.51419.0001		1.51455.1003	273	1.51927.	368	1.52046.0001	207, 234
1.50959.0001	335	270, 271, 284, 316, 317, 320,		1.51456.0001	272	1.51928.	368	1.52047.0001	207, 234
1.50960.0001	339	327, 341, 344, 367, 370, 371		1.51456.1003	273	1.51929.	368	1.52048.0001	207, 234
1.50961.0001	327	1.51431.	367	1.51460.0001	270	1.51930.	368	1.52050.0001	207, 245
1.50962.0001	317	1.51431.7076	337	1.51463.0001	207, 217	1.51931.	368	1.52056.0001	207, 232
1.50963.0001	331	1.51431.7077	337	1.51465.0001	207, 238	1.51932.	368	1.52057.0001	207, 232
1.50973.0001	310	1.51431.7078	323	1.51466.0001	217	1.51933.	368	1.52058.0001	207, 232
1.50974.0001	310	1.51431.7080	316	1.51467.0001	224, 248	1.51934.	368	1.52059.0001	207, 245
1.50975.0001	310	1.51431.7081	316	1.51468.0001	207, 230	1.51935.	368	1.52062.0001	217
1.50980.0001	311	1.51431.7084	317	1.51470.0001	244	1.51936.	368	1.52063.0001	217
1.50981.0001	331	1.51431.7091	327	1.51471.0001	244	1.51937.	368	1.52064.0001	230
1.50981.1003	331	1.51431.7109	341	1.51478.0001	418	1.51938.	368	1.53...	
1.50982.0001	327	1.51431.7127	304	1.51482.0001	418	1.51939.	367	1.53170.0001	207, 236
1.50983.0001	316	1.51431.7138	311	1.51483.0001	418	1.51940.	367	1.53171.0001	207, 236
1.50984.0001	331	1.51431.7141	310	1.51484.0001	418	1.51941.	367	1.53172.0001	207, 236
1.50986.0001	327	1.51432.	367	1.51485.0001	418	1.51942.	367	1.53175.0001	207, 245
1.50987.0001	316	1.51432.7078	323	1.51486.0001		1.51943.	367	1.59...	
1.50993.0001	331	1.51432.7080	316	270, 271, 273, 284, 287, 290,		1.52...		1.59002.1000	26
1.50995.0001	317	1.51432.7084	317	302, 304, 306, 310, 311, 316,		1.52001.0001	207, 217	1.59002.2500	26
1.51...		1.51432.7091	327	317, 320, 323, 327, 331, 335,		1.52002.0001	207, 217	1.59002.4000	26
1.51000.0001	365	1.51432.7109	341	337, 339, 341, 344, 346, 365,		1.52003.0001	207, 217	1.59003.2500	26
1.51013.0001	293	1.51432.7138	311	367, 370, 371, 372		1.52004.0001	207, 244	1.59003.4000	26
1.51014.0001	293	1.51432.7141	310	1.51487.0001		1.52005.0001	207, 244	1.59004.2500	26
1.51160.0001	129, 131	1.51436.0001	306	272, 273, 284, 287, 290, 305,		1.52006.0001	207, 217	1.59004.4000	26
1.51161.0001	129, 130	1.51442.	367	309, 315, 320, 322, 326, 330,		1.52007.0001	207, 217	1.59006.2500	26
1.51192.0001	69	1.51442.7077	337	335, 337, 339, 341, 344, 346,		1.52008.0001	207, 244	1.59006.4000	26
1.51193.0001	69	1.51442.7078	323	365, 368, 375, 376		1.52009.0001	207, 244	1.59007.2500	26
1.51194.0001	69	1.51442.7080	316	1.51496.0001	373	1.52010.0001	245	1.59007.4000	26
1.51196.	368	1.51442.7092	327	1.51901.0001	344	1.52011.0001	207, 245	1.59008.2500	26
1.51236.0001	377	1.51442.7109	341	1.51902.0001	344	1.52012.0001	244	1.59008.4000	26
1.51237.0001	377	1.51442.7138	311	1.51903.0001	344	1.52013.0001	207, 244	1.59013.4000	26
1.51238.0001	377	1.51443.	367	1.51904.0001	337	1.52014.0001	207, 217	1.67..	
1.51252.0001	377	1.51443.7054	344	1.51905.0001	337	1.52015.0001	207, 251	1.67110.0001	36
1.51257.0001	371	1.51443.7085	317	1.51906.0001	315	1.52016.0001	207, 251	1.67730.0001	36
1.51258.0001	371	1.51443.7087	327	1.51907.0001	315	1.52019.0001	217	4.80...	
1.51288.0001	310	1.51444.	367	1.51908.0001	317	1.52020.0001	207, 217	4.80112.2500	26
1.51299.0001	311	1.51444.7141	310	1.51909.0001	311	1.52021.0001	207, 217	4.80112.4000	26
1.51299.1003	311	1.51445.	367	1.51910.0001	311	1.52022.0001	207, 217	4.80112.9030	26
1.51308.0001	310	1.51448.	367	1.51918.0001	287	1.52023.0001	217	4.80159.2500	26
1.51311.0001	346	1.51448.7052	344	1.51918.1003	287	1.52024.0001	244	4.80170.2500	26
1.51315.0001	346	1.51448.7081	316	1.51919.0001	287	1.52025.0001	207, 244	4.80170.4000	26
1.51318.0001	346	1.51448.7088	327	1.51919.1003	287	1.52026.0001	207, 240	4.80448.2500	26
1.51333.0001	365	1.51448.7109	341	1.51920.0001	287	1.52027.0001	207, 240	4.80448.4000	26
1.51343.0001	344	1.51448.7138	311	1.51920.1003	287	1.52028.0001	207, 240	4.80448.9030	26
1.51345.0001	344	1.51448.7184	270	1.51921.0001	287	1.52029.0001	245	4.80508.9030	26
1.51349.0001	344	1.51449.	367	1.51921.1003	287	1.52030.0001	207, 245	4.80672.2500	26
1.51351.0001	344	1.51450.0001	207, 217	1.51922.0001	287	1.52031.0001	202	4.80853.4000	26
1.51353.0001	344	1.51451.0001	207, 244	1.51922.1003	287	1.52032.0001	207, 244	9.20...	
1.51354.0001	344	1.51452.0001	207, 244	1.51923.	368	1.52033.0001	207, 244	9.20078.0001	30
1.51355.0001	344	1.51453.0001	284	1.51924.	368	1.52035.0001	207, 251	9.67...	
1.51356.0001	344	1.51454.0001	284	1.51925.	368	1.52036.0001	207, 251	9.67100.1040	33
1.51384.0001	302	1.51455.0001	272	1.51926.	368	1.52037.0001	207, 251	9.67100.1041	33

Index of ordering numbers

Ordering No.	Page	Ordering No.	Page	Ordering No.	Page	Ordering No.	Page
9.67100.1185	33	SLCR025NK	83, 87	SLHNX13TL	82	XX6...	
9.67100.2001	32	SLCR025NS	83	SLHP033NB	83	XX6200006P	84
9.67100.2002	32	SLCRBZ5NK	89	SLHP033NK	83	Z00...	
9.67100.2004	32	SLCRBZ5NZ	89	SLHP033NS	83	Z00Q0V0VWW	41
9.67100.9051	36	SLCRDZ5NK	89	SLHV033NB	83	ZFR...	
9.67100.9090	36	SLCRDZ5NZ	89	SLHV033NK	83, 87	ZFRE00200	40
9.67100.9100	33, 36	SLCRT13NL	82	SLHV033NS	83	ZFRE00350	40
FHL...		SLF...		SLHVBZ5NK	89	ZFW...	
FHLC04700	84	SLFG025NB	83	SLHVBZ5NZ	89	ZFWATDET4	40, 41, 42
GNW...		SLFG025NK	83	SLHVDZ5NK	89	ZMQ...	
GNWP04700	84	SLFG025NS	83	SLHVDZ5NZ	89	ZMQSFTS01	40, 41, 42
GVW...		SLFGR04NL	82	SLHVR04NK	82	ZMQSP0D01	41, 42
GVWP04700	84	SLFGX13NK	82	SLHVR04NL	82, 87	ZRX...	
GVWP09050	84	SLFGX13NL	82	SLHVX13NK	82, 87	ZRXQ003WW	42
HNW...		SLFGX13TL	82	SLHVX13NL	82	ZRXQ005WW	42
HNWP04700	84	SLFH025NB	83	SLHVX13TL	82	ZRXQ010WW	42
HVW...		SLFH025NK	83	SLL...		ZRXQ015WW	42
HVWP04700	84	SLFH025NS	83	SLLGC13NL	82	ZRXSP0D01	40, 42
HVWP09050	84	SLFHR04NL	82	SLLGC25NS	83	ZRXSUPCL1	40
JGW...		SLFHX13NK	82	SLLGDZ5NK	89	ZRXSUPEG1	40
JGWP04700	84	SLFHX13NL	82	SLLGDZ5NZ	89	ZRXSUPUV1	40
JGWP09025	84	SLFHX13TL	82	SLLGH13NK	82, 87	ZRXV003WW	40
LAB...		SLG...		SLLGH13NL	82	ZRXV005WW	40
LABCLOSE1	40	SLGN033NB	83	SLLGH25NB	83	ZRXV010WW	40
LCP...		SLGN033NK	83	SLLGH25NK	83, 87	ZRXV015WW	40
LCPAK0001	41, 42	SLGN033NS	83	SLLGH25NS	83		
MPG...		SLGNDZ5NK	89	SLLGR04NL	82, 87		
MPGP04001	41, 42	SLGNDZ5NZ	89	SLLHC13NL	82		
POD...		SLGNX13NK	82	SLLHC25NS	83		
PODCOVER1	40	SLGNX13NL	82	SLLHR04NK	82		
PRO...		SLGNX13TL	82	SLLHR04NL	82, 87		
PROG0T0S2	42	SLGP033NB	83	SLLS025NS	83		
QGA...		SLGP033NK	83	SLP...			
QGARDT1X1	41	SLGP033NS	83	SLPBDZ5NK	89		
QTU...		SLGV033NB	83	SLPBDZ5NZ	89		
QTUM0TEX1	41, 42	SLGV033NK	83, 87	TAN...			
SAM...		SLGV033NS	83	TANKASMIN	40, 42		
SAMPHV001	93	SLGVR04NK	82	TANKPE030	40, 42		
SAMPHV004	93	SLGVR04NL	82, 87	TANKPE060	40, 42		
SAMPLCR01	93	SLGVX13NK	82, 87	TANKPE100	40, 42		
SAMPLCR04	93	SLGVX13NL	82	WMB...			
SAMPLG001	93	SLGVX13TL	82	WMBQPOD01	40, 41, 42		
SAMPLG004	93	SLH...		WMBSMT002	40, 42		
SAMPSYBL	93	SLHN033NB	83	WP6...			
SAMSYSLID	93	SLHN033NK	83	WP6110060	93		
SAMTUBING	93	SLHN033NS	83	WP6111560	84		
SAMVIALTR	93	SLHNBZ5NK	89	WP6111560	93		
SAMWASTTR	93	SLHNBZ5NZ	89	WP6122050	84		
SLC...		SLHNDZ5NK	89	WP6122050	93		
SLCR013NK	82, 87	SLHNDZ5NZ	89	XX1...			
SLCR013NL	82	SLHNX13NK	82	XX1009020	84		
SLCR025NB	83	SLHNX13NL	82	XX1504700	84		

Analytical Application Finder

Searching for a particular application?
Find it quickly and easily on our comprehensive
Analytical Application Finder.



www.merckmillipore.com/aaf

Merck Millipore around the world

Address information: October 2014

Merck Millipore is represented throughout the world by companies of the Merck group or by local partners.

ALBANIA

VARUS
Ul. Skupi bb. 15
1000 SKOPJE, MACEDONIA
Phone +389 (0) 2 311 5122
Telefax +389 (0) 2 313 7013
E-mail varus@varus.com.mk
Internet www.varus.com.mk

ALGERIA

PHARMASCIENCE Eurl
Résidence les Oliviers
Bt M4/2. N° 469
42445 DOUAOUA – TIPAZA, ALGERIA
Phone +213 (24) 408 081
Mobile +213 661 674 132
Telefax +213 (24) 409 555
E-mail pharmascience_eurl@yahoo.fr

ARGENTINA

MERCK QUIMICA ARGENTINA S.A.I.C.
4890 Tronador Street
Panamericana Plaza Building – 5th floor
1430 BUENOS AIRES, ARGENTINA
Phone +54 (0) 11 4546 8100 opción 1
Telefax +54 (0) 11 4546 8157
E-mail merck@merck.com.ar
Internet www.merckmillipore.com.ar

ARMENIA

MERCK İLAÇ ECZA VE KİMYA TİC. A.Ş.
Kayisdagi Caddesi, Karaman Ciftligi Yolu
Kar Plaza, No 45 Kat 7,
34752 ICERENKOY-İSTANBUL, TURKEY
Phone +90 216 5786 600
Telefax +90 216 4690 922
E-mail info@merck-chemicals.com.tr
Internet www.merckmillipore.com

AUSTRALIA

MERCK MILLIPORE
AUSTRALIA
Phone +61 3 9728 7600
Telefax +61 3 9728 1351
E-mail orders.aus@merckgroup.com
Internet www.merckmillipore.com.au

AUSTRIA

Phone +49 (0) 8102 802 173
Telefax +49 (0) 8102 802 201
Orders customerservice@merckgroup.com

AZERBAIJAN

MERCK İLAÇ ECZA VE KİMYA TİC. A.Ş.
Kayisdagi Caddesi, Karaman Ciftligi Yolu
Kar Plaza, No 45 Kat 7,
34752 ICERENKOY-İSTANBUL, TURKEY
Phone +90 216 5786 600
Telefax +90 216 4690 922
E-mail info@merck-chemicals.com.tr
Internet www.merckmillipore.com

BAHRAIN

SOLYMAN SERVICES (UK) Ltd.
P.O. Box 8611, SAIF Zone, SHARJAH, U.A.E.
Phone +971 (0) 6 557 2266
E-mail ssl.ho@solymanservices.com
Internet www.solymanservices.com

TECHNOCHEM TRADING
Flat 32, Bldg. 1843, Block 704, St/Road 433,
Salmabad, MANAMA, BAHRAIN
Phone +973 7707 7790
E-mail mark@technocheminfo.com
Internet www.technocheminfo.com

AL JISHI
Salmaniya Ave.
P.O. Box 617, MANAMA, BAHRAIN
Phone +937 1723 3544
E-mail jishi@aljishi.com

BANGLADESH

G.A. TRADERS
48/1, Purana Paltan, 3rd floor
DHAKA-1000, BANGLADESH
Phone +880 (0) 2896 3502
+880 (0) 2955 7299
Mobile +880 171 301 7505
Telefax +880 (0) 2896 3519
E-mail gat.bangladesh@gmail.com
gat.1988@yahoo.com

BELARUS

CHEMTECH
TechnoPark, Office 703-704
Leninskaya Str. 63
212030 MOGILEV, BELARUS
Phone +375 222 220 822
Telefax +375 222 220 822
E-mail igorsilyin@hotmail.com

MALKUT
Minsk region, Smolevichi, Torgovaya St. 16-20
222201 MINSK, BELARUS
Phone +375 17 298 9549
Telefax +375 17 212 7867
E-mail merck@vitus.by

BELGIUM

Phone +49 (0) 6151 72 2891
Telefax +49 (0) 6151 72 912 891
Orders customerservice@merckgroup.com

BELIZE

MERCK S.A.
12 ave. 0-33, zona 2 de Mixco,
Código Postal 01057
CIUDAD DE GUATEMALA, GUATEMALA
Phone +502 2410 2300
Telefax +502 2434 2954
E-mail quimicos@merckgroup.com
Internet www.merckmillipore.com

BOLIVIA

CORIMEX LTDA.
Calle Montevideo No. 130
Edif. Requima, entre Capitán Ravelo y Av. Arce.
LA PAZ, BOLIVIA
Phone +591 2 2440 330
Telefax +591 2 2440 230
E-mail bacruz@corimex.com
ogallo@corimex.com

BRAZIL

MERCK MILLIPORE, SÃO PAULO
Rua São Paulo, 30 – Alphaville Industrial
06465-130 BARUERI – SÃO PAULO, BRAZIL
Phone +55 (0) 11 4133 8700
Telefax +55 (0) 11 4191 2779
E-mail quimica@merckgroup.com.br
Internet www.merckmillipore.com.br

BULGARIA

MERCK BULGARIA EAD
Blvd. Sitnyakovo 48
1505 SOFIA, BULGARIA
Phone +359 (0) 2 4461 111
Telefax +359 (0) 2 4461 100
E-mail merck@merck.bg
Internet www.merckmillipore.bg

CANADA

EMD Millipore Corporation
290 Concord Road
BILLERICA, MA 01821, USA
Phone +1 800 222 0342
+1 978 715 4321
Telefax +1 800 776 0999
E-mail Customer.CareDesk@merckgroup.com
Internet www.emdmillipore.com

CHILE

MERCK S.A.
Francisco de Paula Taforo 1981
Casilla 48-D
SANTIAGO DE CHILE, CHILE
Phone +56 (0) 2 23400 000
Telefax +56 (0) 2 23400 199
E-mail mqch@merckgroup.com
Internet www.merckmillipore.cl

CHINA

Merck Chemicals (Shanghai) Co., Ltd.
3/F, Tower 2, Kingdee Building,
No. 88 Chenhui Road,
Zhangjiang Hi-Tech Park, Pu Dong
SHANGHAI 201203, CHINA
Phone +86 (0) 21 2033 8288
Telefax +86 (0) 21 6249 6124
E-mail Reception@merck-china.com
Internet www.merckmillipore.com/china

Merck Beijing Rep. Office
18F, Building A, Phoenix Place, No. A5 Shuguangxili
Chaoyang District
BEIJING 100028, CHINA
Phone +86 10 5989 8600
Telefax +86 10 5762 3560
E-mail Reception@merck-china.com
Internet www.merckmillipore.com/china

Merck Guangzhou Rep. Office
Room 802, Yi An Plaza No. 33, Jian She 6th Road
GUANGZHOU 510060, CHINA
Phone +86 (0) 20 8363 4531
Telefax +86 (0) 20 8363 4347
E-mail Reception@merck-china.com
Internet www.merckmillipore.com/china

COLOMBIA

MERCK S.A.
Calle 10 No. 65 – 28
Apartado Aéreo 9896
BOGOTÁ D.C., COLOMBIA
Phone +57 (0) 1 425 4770
Telefax +57 (0) 1 425 5407
E-mail mcsa@merck.com.co
Internet www.merckmillipore.co

COSTA RICA

MERCK S.A.
12 ave. 0-33, zona 2 de Mixco,
Código Postal 01057
CIUDAD DE GUATEMALA, GUATEMALA
Phone +502 2410 2300
Telefax +502 2434 2954
E-mail quimicos@merckgroup.com
Internet www.merckmillipore.com

CROATIA

MERCK D.O.O.
Andrije Hebranga 32
10000 ZAGREB, CROATIA
Phone +385 1 4864 111
Telefax +385 1 4864 190
E-mail merck@merck.hr
Internet www.merckmillipore.com.hr

CUBA

MERCK S.A.
Calle 3 era."A" No. 15209, 152 y 154
Reperto Nautico
CIUDAD HABANA, CUBA
Phone +537 208 7903 04
Telefax +537 208 7686
E-mail myanes@enet.cu
Internet www.merckmillipore.com

CYPRUS

A.J. VOUIROS Ltd.
14 Proponentos Street
Strovolos Industrial Area
2090 NICOSIA, CYPRUS
Phone +357 22 442 822
Telefax +357 22 518 093
E-mail klitosth@logosnet.cy.net
Internet www.ajvouros.com

CZECH REPUBLIC

MERCK SPOL. s r.o.
Na Hrebenech II, 1718/10
140 00 PRAHA 4, CZECH REPUBLIC
Phone +420 (0) 272 084 272
Telefax +420 (0) 272 084 303
E-mail czchemie@merckgroup.com
Internet www.merckmillipore.cz

DENMARK

Phone +49 (0) 6151 72 2891
Telefax +49 (0) 6151 72 912 891
Orders customerservice@merckgroup.com

DOMINICAN REPUBLIC

MERCK S.A.
12 ave. 0-33, zona 2 de Mixco,
Código Postal 01057
CIUDAD DE GUATEMALA, GUATEMALA
Phone +502 2410 2300
Telefax +502 2434 2954
E-mail quimicos@merckgroup.com
Internet www.merckmillipore.com

ECUADOR

MERCK ECUADOR C.A.
Avda. Amazonas 4545 y Pereira
Edificio Centro Financiero – Piso 6
QUITO – ECUADOR
Phone +593 2 2981 677
Telefax +593 2 2981 644
E-mail sicmerck@merck.com.ec
Internet www.merckmillipore.ec

Merck Millipore around the world

EGYPT

NEFERTITI
9 El Sharekat St. El Opera,
Abdeen, Armanious Croup Tower
CAIRO, EGYPT
Phone +20 2 2399 2700
+20 2 2399 2760
Telefax +20 2 2399 2783
E-mail nefertiti@nefertitech.com
Internet www.nefertitech.com

ELGHONEMY GROUP
21 elfardous st, Abbassya 11381.
CAIRO, EGYPT

Phone +20 2 2674 5877
+20 2 2674 5870
+20 2 2685 9688
Telefax +20 2 2685 9677
E-mail info@elghonemy.com.eg
Internet www.elghonemy.com.eg

EL SALVADOR

MERCK S.A.
12 ave. 0-33, zona 2 de Mixco,
Código Postal 01057
CIUDAD DE GUATEMALA, GUATEMALA
Phone +502 2410 2300
Telefax +502 2434 2954
E-mail quimicos@merckgroup.com
Internet www.merckmillipore.com

ESTONIA

MERCK KGaA
Frankfurter Straße 250
64293 Darmstadt, GERMANY
Phone +49 (0) 6151 72 0
Telefax +49 (0) 6151 72 2000
E-mail service@merckgroup.com
Internet www.merckmillipore.com

FINLAND

Phone +49 (0) 6151 72 2891
Telefax +49 (0) 6151 72 912 891
Orders customerservice@merckgroup.com

FRANCE

Phone +49 (0) 6151 72 2891
Telefax +49 (0) 6151 72 912 891
Orders customerservice@merckgroup.com

GEORGIA

MERCK İLAÇ ECZA VE KİMYA TİC. A.Ş.
Kayisdagi Caddesi, Karaman Ciftligi Yolu
Kar Plaza, No 45 Kat 7,
34752 ICERENKOY-İSTANBUL, TURKEY
Phone +90 216 5786 600
Telefax +90 216 4690 922
E-mail info@merck-chemicals.com.tr
Internet www.merckmillipore.com

GHANA

PKF SCIENTIFIC LTD
Appiawah House
Spintex Road
Plot CS Parakuo Estates
ACCRA, GHANA
Phone +233 303 404 452
Telefax +233 303 404 453
E-mail pkfscience@yahoo.com

GERMANY

Phone +49 (0) 8102 802 173
+49 (0) 8102 802 176
Telefax +49 (0) 8102 802 201
Orders customerservice@merckgroup.com

GREAT BRITAIN

Phone +49 (0) 6151 72 2891
Telefax +49 (0) 6151 72 912 891
Orders customerservice@merckgroup.com

GREECE

MERCK A.E HELLAS
41-45 Kifisias av. (Building B)
15123 Marousi, Athens, GREECE
Phone +30 210 616 5164
Telefax +30 210 610 1386
E-mail Merck.Chem.gr@merck.de
Internet www.merckmillipore.gr

GUATEMALA

MERCK S.A.
12 ave. 0-33, zona 2 de Mixco,
Código Postal 01057
CIUDAD DE GUATEMALA, GUATEMALA
Phone +502 2410 2300
Telefax +502 2434 2954
E-mail quimicos@merckgroup.com
Internet www.merckmillipore.com

HONDURAS

MERCK S.A.
12 ave. 0-33, zona 2 de Mixco,
Código Postal 01057
CIUDAD DE GUATEMALA, GUATEMALA
Phone +502 2410 2300
Telefax +502 2434 2954
E-mail quimicos@merckgroup.com
Internet www.merckmillipore.com

HUNGARY

MERCK Kft.
Oktober huszonharmadika utca 6-10
1117 BUDAPEST, HUNGARY
Phone +36 1 4638 100
Telefax +36 1 4638 101
E-mail kemia@merck.hu
Internet www.merckmillipore.hu

INDIA

Merck Specialities Private Ltd.
Lloyds Centre Point, 1st floor
Appasaheb Marathe, Marg Prabhadevi, INDIA
Phone +91 (22) 2761 3184 [customer service]
+91 (22) 2761 3185 [customer service]
E-mail merckmillipore.india@merckgroup.com
Internet www.merckmillipore.in

INDONESIA

P.T. MERCK Tbk.
JL. T.B. Simatupang No. 8
Pasar Rebo
JAKARTA 13760, INDONESIA
Phone +62 21 2856 5600
Telefax +62 21 2856 5603
E-mail chemicals.id@merckgroup.com
Internet www.merckmillipore.co.id
www.merck.co.id

IRAQ

HEAVY EQUIPMENT CENTER H.E.C.
No. 825, St. 108 Ainkawa,
ERBIL, IRAQ
Phone +964 750 371 0049
E-mail dana.mike@rocketmail.com

IRELAND

Phone +49 (0) 6151 72 2891
Telefax +49 (0) 6151 72 912 891
Orders customerservice@merckgroup.com

ISRAEL

MERCURY SCIENTIFIC & INDUSTRIAL PRODUCTS Ltd.
P. O. Box 159
12, Ha'avoda St.
ROSH HA'AYIN 48101, ISRAEL
Phone +972 (0) 3 9387 164
Telefax +972 (0) 3 9387 174
E-mail mercury@mercury-ltd.co.il
Internet www.mercury-ltd.com

ITALY

Phone +49 (0) 6151 72 2891
Telefax +49 (0) 6151 72 912 891
Orders customerservice@merckgroup.com

JAPAN

Merck Ltd. Japan
ARCO Tower 5F
8-1, Shimomeguro 1-chome, Meguro-ku
TOKYO 153-8927, JAPAN
Phone +81 (0) 3 5434 4700
Telefax +81 (0) 3 5434 5076
E-mail service@merck.co.jp
Internet www.merck.co.jp

JORDAN

HENRY MARROUM & SONS/ LAB. SERVE
4, Bin Asaker St. Weibdeh Al-Gharbi, AMMAN, JORDAN
[delivery address]

P. O. Box 589, AMMAN 11118, JORDAN
[mailing address]
Phone +962 (0) 6 565 1505
Telefax +962 (0) 6 565 1510
E-mail info@labserve.com.jo
Internet www.labserve.com.jo

KOSOVO

VARUS
Ul. Skupi bb. 15
1000 SKOPJE, MACEDONIA
Phone +389 (0) 2 311 5122
Telefax +389 (0) 2 313 7013
E-mail varus@varus.com.mk
Internet www.varus.com.mk

KUWAIT

KUWAIT LAB
General Trad, Et Cont. Est.
P.O. Box 44693,
32064 HAWALLY, KUWAIT
Phone +965 2633 373
+965 2633 374
Telefax +965 2633 375
E-mail kwtcreativity@yahoo.com

SOLYMAN SERVICES (UK) Ltd.
Sharjah Airport International Free Zone
P.O. Box 8611
SHARJAH, U.A.E.
Phone +971 6557 2266
Telefax +971 6557 2271
E-mail ssl.ho@solymanservices.com
Internet www.solymanservices.com

KYRGYZSTAN

MERCK ILAÇ ECZA VE KIMYA TIC. A.S.
Kayisdagi Caddesi, Karaman Ciftligi Yolu
Kar Plaza, No 45 Kat 7,
34752 ICERENKOY-ISTANBUL, TURKEY
Phone +90 216 5786 600
Telefax +90 216 4690 922
E-mail info@merck-chemicals.com.tr
Internet www.merckmillipore.com

LATVIA

MERCK KGaA
Frankfurter Straße 250
64293 Darmstadt, GERMANY
Phone +49 (0) 6151 72 0
Telefax +49 (0) 6151 72 2000
E-mail service@merckgroup.com
Internet www.merckmillipore.com

LEBANON

CHEMICAL & GENERAL SUPPLIERS S.A.R.L.
Achrafieh-Fassouh-Rue Mgr. Atalla Street
Maria Del Carmen Bldg.
P.O. Box 16
5908 BEIRUT, LEBANON
Phone +961 334 9579
E-mail cgsleb@dm.net.lb
import@chemicalandgeneral.com
Internet www.chemicalandgeneral.com

LIBYA

ALMAREFA FOR TECHNICAL EQUIPMENT
Salah Al Deen, near the customs building,
TRIPOLI, LIBYA
Phone +218 91 484 8496
E-mail almarefa.technical@yahoo.de

LITHUANIA

MERCK KGaA
Frankfurter Straße 250
64293 Darmstadt, GERMANY
Phone +49 (0) 6151 72 0
Telefax +49 (0) 6151 72 2000
E-mail service@merckgroup.com
Internet www.merckmillipore.com

LUXEMBOURG

Phone +49 (0) 6151 72 2891
Telefax +49 (0) 6151 72 912 891
Orders customerservice@merckgroup.com

MACEDONIA

VARUS
Ul. Skupi bb. 15
1000 SKOPJE, MACEDONIA
Phone +389 (0) 2 311 5122
Telefax +389 (0) 2 313 7013
E-mail varus@varus.com.mk
Internet www.varus.com.mk

MALAYSIA

MERCK MILLIPORE DIVISION
Merck Sdn Bhd
Level 3, Menara Sunway Annexe
Jalan Lagoon Timur, Bandar Sunway
46150 Petaling Jaya
SELANGOR DARUL EHSAN, MALAYSIA
Phone +603 7494 3688 [general line]
+603 7494 3788 [customer service hotline]
+603 7494 3686 [sales support hotline]
Telefax +603 7491 0840
E-mail chemorders.my@merckgroup.com
[customer service]
chemquotes.my@merckgroup.com
[sales support]
Internet www.merckmillipore.my

MALTA

EVOLVE LTD.
Canter Business Center
P.F. Bilocca Street
1524 Marsa MRS, MALTA
Phone +356 (0) 2 569 2120
Telefax +356 (0) 2 122 0186
E-mail cbusuttil@evolveltd.eu
Internet www.evolveltd.eu

MÉXICO

MERCK, S.A. DE C.V.
Calle 5, No. 7 Frac. Industrial Alce Blanco,
Naucalpan de Juárez
EDO, DE MÉXICO C.P. 53370, MEXICO
Phone +52 (0) 55 2122 1600
Telefax +52 (0) 55 2122 1652
Internet www.merckmillipore.com
www.merck-pm.com

MOROCCO

GENOME BIOTECHNOLOGIES
Parc d'Activité Oukacha
Immeuble E N°13
20250 AIN SEBAA CASABLANCA, MOROCCO
Phone +212 522 343 376
+212 522 343 382
Mobile +212 661 409 295
Telefax +212 522 344 135
E-mail driss.squalli@genome-biotechnologie.com

NETHERLANDS

Phone +49 (0) 6151 72 2891
Telefax +49 (0) 6151 72 912 891
Orders customerservice@merckgroup.com

NEW ZEALAND

MERCK MILLIPORE
PO Box 76171
MANUKAU CITY 2241, AUCKLAND, NEW ZEALAND
Phone +64 (0) 800 463 725
Telefax +64 (0) 6 356 7311
E-mail orders.nz@merckgroup.com
Internet www.merckmillipore.co.nz

NICARAGUA

MERCK S.A.
12 ave. 0-33, zona 2 de Mixco,
Código Postal 01057
CIUDAD DE GUATEMALA, GUATEMALA
Phone +502 2410 2300
Telefax +502 2434 2954
E-mail quimicos@merckgroup.com
Internet www.merckmillipore.com

NIGERIA

CORMART NIGERIA LIMITED
Plot 14, Chivita Avenue
Ajao Estate, Apakun Oshodi,
P. O. Box 2978,
IKEJA, LAGOS., NIGERIA
Phone +234 1 774 4402
+234 1 774 0383
+234 1 280 67709
+234 1 761 6605
Telefax +234 1 271 9265
E-mail cormart@clicktgi.net
Internet www.cormart-nigeria.com

NORTHERN IRELAND

Phone +49 (0) 6151 72 2891
Telefax +49 (0) 6151 72 912 891
Orders customerservice@merckgroup.com

NORWAY

Phone +49 (0) 6151 72 2891
Telefax +49 (0) 6151 72 912 891
Orders customerservice@merckgroup.com

OMAN

SOLYMAN SERVICES (UK) Ltd.
Sharjah Airport International Free Zone
P.O. Box 8611
SHARJAH, U.A.E.
Phone +971 6557 2266
Telefax +971 6557 2271
E-mail ssl.ho@solymanservices.com
Internet www.solymanservices.com

LABORATORY SCIENTIFIC SUPPLIES F.Z.C
P.O. Box 440
SULTANATE OF OMAN
Phone +968 9293 2984
Telefax +968 2450 2399
E-mail ehtesham@lab-suppliers.com
Internet www.lab-suppliers.com

PAKISTAN

MERCK (PRIVATE) LIMITED
D/7, Shaheed-e-Millat Road
75350 KARACHI, PAKISTAN
Phone +92 (0) 21 345 592 1017
+92 (0) 21 111 523 523 [U.A.N.]
+92 (0) 800 123 11 [toll-free call]
Telefax +92 (0) 21 345 352 94
E-mail chem-query@merckgroup.com
Internet www.merckmillipore.pk

PANAMA

MERCK S.A.
12 ave. 0-33, zona 2 de Mixco,
Código Postal 01057
CIUDAD DE GUATEMALA, GUATEMALA
Phone +502 2410 2300
Telefax +502 2434 2954
E-mail quimicos@merckgroup.com
Internet www.merckmillipore.com

PARAGUAY

VICENTE SCAVONE Y CIA. C.I.S.A.
Pastora Cespedes y Don Vicente Scavone N° 475
SAN LORENZO, PARAGUAY
Phone +595 (0) 21 522 322
Fax +595 (0) 21 501 267
E-mail lacsa@lacsa.com.py
crizzi@lacsa.com.py
Internet www.lasca.com.py

PERU

MERCK PERUANA S.A.
Av. Los Frutales No. 220 Ate
LIMA 3, PERU
Phone +51 (0) 1 618 7500
Telefax +51 (0) 1 341 0483
E-mail ventas.quimica@merckgroup.com
Internet www.merckmillipore.pe

PHILIPPINES

MERCK, Inc.
24th floor GT Tower International
6813 Ayala Avenue corner
H.V. dela Costa Street
Salcedo Village
1227 MAKATI CITY, PHILIPPINES
Phone +63 (2) 815 4067
Telefax +63 (2) 815 4882
+63 (2) 815 4883
E-mail customer.care@merck.ph
Internet www.merckmillipore.ph

POLAND

MERCK Sp. z o.o.
ul. Jutrzenki 137
02-231 WARSZAWA, POLAND
Phone +48 (0) 22 5359 770
+48 (0) 22 5359 700
Telefax +48 (0) 22 5359 945
+48 (0) 22 5359 703
E-mail dzial.handlowy@merckgroup.com
Internet www.merckmillipore.pl

PORTUGAL

Phone +49 (0) 6151 72 2891
Telefax +49 (0) 6151 72 912 891
Orders customerservice@merckgroup.com

QATAR

SOLYMAN SERVICES (UK) Ltd.
Sharjah Airport International Free Zone
P.O. Box 8611
SHARJAH, U.A.E.
Phone +971 6557 2266
Telefax +971 6557 2271
E-mail ssl.ho@solymanservices.com
Internet www.solymanservices.com

TECHNOCHEM LIMITED
P.O. Box 11536 Doha, QATAR
Phone +974 4441 6979
Telefax +974 4441 2587
E-mail taha@technochemlimited.com

ROMANIA

MERCK ROMANIA S.R.L.
Calea Pleveni 139, Copr C, Et. 2, Sector 6
060011 BUCKAREST, ROMANIA
Phone +40 (0) 21 319 8850
Telefax +40 (0) 21 319 8848
E-mail merck.ro@merckgroup.com
Internet www.merckmillipore.ro

RUSSIA

LLC MERCK
Leninsky prosp., 113/1, E-718
117198 MOSCOW, RUSSIA
Phone +7 495 931 9191
Telefax +7 495 931 9187
E-mail office@merck.ru
Internet www.merckmillipore.ru

SAUDI ARABIA

CIGALAH GROUP
Khaled Bin Waleed Street, 21435,
JEDDAH, SAUDI ARABIA
Phone +966 2 614 8450
Telefax +966 2 657 8861
E-mail mhakim@cigalah.com.sa

SALEH & ABDULAZIZ ABAHSAIN Co. Ltd.
P.O. Box 209
AL-KHOBAR 31952, SAUDI ARABIA
Phone +966 3 898 4045
Telefax +966 3 895 1160
E-mail WAziz@Abahsain.com

SOLYMAN SERVICES (UK) Ltd.
P. O. Box 4946
JEDDAH 21411, SAUDI ARABIA
Phone +966 2 283 1583
Telefax +966 2 283 1983
E-mail ssl.ho@solymanservices.com
Internet www.solymanservices.com

SERBIA

NOVOS d.o.o.
Cara Dusana 207
11080 BELGRAD – ZEMUN, SERBIA
Phone +381 (0) 11 377 3503
Telefax +381 (0) 11 377 3504
E-mail novos@novos.co.rs
Internet www.novos.co.rs

SINGAPORE

MERCK MILLIPORE DIVISION
Merck Pte Ltd
3 International Business Park
#02-01 Nordic European Centre
SINGAPORE 609927
Phone +65 6890 6638 [general line]
+65 6890 6633 [customer service hotline]
+65 6890 0828 [sales support hotline]
Fax +65 6890 6639
E-mail chemorders.sg@merckgroup.com
[customer care]
chemquotes.sg@merckgroup.com
[sales support]
Internet www.merckmillipore.sg

SLOVAKIA

MERCK SPOL. s r. o.
Dvořákovo nábrežie 4
810 06 BRATISLAVA 16, SLOVAKIA
Phone +421 (0) 2 4926 7276
Telefax +421 (0) 2 4926 7799
E-mail skchemie@merckgroup.com
Internet www.merckmillipore.sk

SLOVENIA

MERCK d.o.o.
Ameriška ulica 8
1000 LJUBLJANA, SLOVENIA
Phone +386 1 560 3800
Telefax +386 1 560 3830
E-mail info@merck.si
Internet www.merckmillipore.si

SOUTH AFRICA

MERCK Pty. Ltd. CHEMICALS DIVISION
P. O. Box 1998
HALFWAY HOUSE 1685, SOUTH AFRICA
Phone +27 (0) 860 063 725
Telefax +27 (0) 860 522 329
E-mail labsupply@merck.co.za
Internet www.merckmillipore.co.za

SOUTH KOREA

MERCK Ltd. KOREA
15th floor, Haesung-2-Bldg.,
508 Teheran-Ro, Gangnam-gu,
SEOUL 135-725, SOUTH KOREA
Phone +82 (0) 2 218 538 403
Telefax +82 (0) 2 218 538 30
E-mail products@merck.co.kr
Internet www.merckmillipore.kr

SPAIN

Phone +49 (0) 6151 72 2891
Telefax +49 (0) 6151 72 912 891
Orders customerservice@merckgroup.com

SWEDEN

Phone +49 (0) 6151 72 2891
Telefax +49 (0) 6151 72 912 891
Orders customerservice@merckgroup.com

SWITZERLAND

Phone +49 (0) 8102 802 176
Telefax +49 (0) 8102 802 201
Orders customerservice@merckgroup.com

SYRIA

DROGUERIE SYRIE
Kostaki Homsí Street 106, Suite 3
P. O. Box 5441
ALEPPO, SYRIA
Phone +963 (0) 21 211 6060
Telefax +963 (0) 21 211 6062
E-mail sales@drogueriesyrie.com
Internet www.drogueriesyrie.com

TAIWAN

Merck Ltd.
6F., No. 89, Sec.2, Tiding Blvd., Neihu Dist.
TAIPEI City 114, TAIWAN
Phone +886 2 2162 1111
Telefax +886 2 8751 6262
E-mail service@merck.com.tw
Internet www.merckmillipore.com.tw

TAJIKISTAN

MERCK İLAÇ ECZA VE KİMYA TİC. A.Ş.
Kayisdagi Caddesi, Karaman Ciftligi Yolu
Kar Plaza, No 45 Kat 7,
34752 ICERENKOY-İSTANBUL, TURKEY
Phone +90 216 5786 600
Telefax +90 216 4690 922
E-mail info@merck-chemicals.com.tr
Internet www.merckmillipore.com

Merck Millipore around the world

THAILAND

MERCK Ltd.
622 Emporium Tower, 19th floor,
Sukhumvit Rd., Klongton, Klongtoey
BANGKOK 10110, THAILAND
Phone +66 (0) 2 667 8000
Telefax +66 (0) 2 667 8338
E-mail thcustomerservice@merckgroup.com
Internet www.merckmillipore.com

TUNISIA

FILTRATION & TECHNIQUES de SÉPARATION (F.T.S)
34, RUE GHORNATA
CITÉ DE FOIRE
2089 LE KRAM, TUNISIA
E-mail bammar.moez@planet.tn
Phone +216 (71) 979 361
Mobile +216 2458 2612
Fax +216 (71) 979 362

TURKEY

MERCK İLAÇ ECZA VE KİMYA TİC. A.Ş.
Kayisdagi Caddesi, Karaman Ciftligi Yolu
Kar Plaza, No 45 Kat 7,
34752 ICERENKOY-İSTANBUL, TURKEY
Phone +90 216 5786 600
Telefax +90 216 4690 922
E-mail info@merck-chemicals.com.tr
Internet www.merckmillipore.com

TURKMENISTAN

MERCK İLAÇ ECZA VE KİMYA TİC. A.Ş.
Kayisdagi Caddesi, Karaman Ciftligi Yolu
Kar Plaza, No 45 Kat 7,
34752 ICERENKOY-İSTANBUL, TURKEY
Phone +90 216 5786 600
Telefax +90 216 4690 922
E-mail info@merck-chemicals.com.tr
Internet www.merckmillipore.com

U.A.E.

LABORATORY SCIENTIFIC SUPPLIES F.Z.C.
C-21, Gate No. 4
Aiman Free Zone
P.O. Box 5197, U.A.E.
Phone +971 (6) 7408 841
+971 (6) 7408 842
Telefax +971 (6) 7408 843
E-mail lsscheme@lab-suppliers.com
Internet www.lab-suppliers.com

SOLYMAN SERVICES (UK) Ltd.
Sharjah Airport International Free Zone
P.O. Box 8611
SHARJAH, U.A.E.
Phone +971 6557 2266
Telefax +971 6557 2271
E-mail ssl.ho@solymanservices.com
Internet www.solymanservices.com

UKRAINE

WITEC GROUP Ltd:
25 Chapaevskoy divizii str., 6/1, of. 134
65101 ODESSA, UKRAINE
Phone +38 (0) 48 777 9175
Telefax +38 (0) 48 777 9173
E-mail info@witec.com.ua

CHEMLABORREACTIV Ltd.
Schelkivska 8, Kyivskiy reg.
007400 BROVARY, UKRAINE
Phone +38 (0) 44 494 4242
Telefax +38 (0) 44 494 4242
E-mail bereshuk@chemlab.kiev.ua

URUGUAY

TÉCNICA DEL PLATA LTDA.
W Ferreira Aldunate 1234
MONTEVIDEO 11100, URUGUAY
Phone +598 2908 4866
Telefax +598 2908 5505
E-mail info@tecnicadelplata.com.uy
ana.leon@tecnicadelplata.com.uy
Internet www.tecnicadelplata.com.uy

USA

EMD Millipore Corporation
290 Concord Road
BILLERICA, MA 01821, USA
Phone +1 800 645 5476
Telefax +1 800 645 5439
E-mail nacustomerservice@emdmillipore.com
Internet www.EMDMillipore.com

Direct Contact for Lab Chemicals and Products
Phone +1 866 645 5476
Telefax +1 800 776 0999
E-mail LEorders@emdmillipore.com

UZBEKISTAN

MERCK İLAÇ ECZA VE KİMYA TİC. A.Ş.
Kayisdagi Caddesi, Karaman Ciftligi Yolu
Kar Plaza, No 45 Kat 7,
34752 ICERENKOY-İSTANBUL, TURKEY
Phone +90 216 5786 600
Telefax +90 216 4690 922
E-mail info@merck-chemicals.com.tr
Internet www.merckmillipore.com

VENEZUELA

MERCK S.A.
Calle Hans Neumann, Edificio Corimón,
Piso 3, Los Cortijos de Lourdes
Apartado 2020
CARACAS, VENEZUELA
Phone +58 (0) 212 235 1379
Telefax +58 (0) 212 237 7632
E-mail mven@merck.com.ve
Internet www.merckmillipore.ve

VIETNAM

MERCK Ltd.
9th floor, Centre Point,
106 Nguyen Van Troi St.,
Phu Nhuan District,
HO CHI MINH CITY, VIETNAM
Phone +84 8 (0) 3842 0100
Telefax +84 8 (0) 3842 0120
E-mail merckvn-care@merck.vn
merckserono@merck.vn

YEMEN

SOLYMAN SERVICES (UK) Ltd.
Sharjah Airport International Free Zone
P.O. Box 8611
SHARJAH, U.A.E.
Phone +971 6557 2266
Telefax +971 6557 2271
E-mail ssl.ho@solymanservices.com
Internet www.solymanservices.com

OTHER COUNTRIES

MERCK KGaA
Frankfurter Straße 250
64293 Darmstadt, GERMANY
Phone +49 (0) 6151 72 0
Telefax +49 (0) 6151 72 2000
E-mail service@merckgroup.com
Internet www.merckmillipore.com